



# PERKO

**MARINE  
CATALOG**

**No. 170**

S E R V I N G   T H E   I N D U S T R Y   S I N C E   1 9 0 7





**Catalog No. 170**

1960

# **PERKINS MARINE LAMP AND HARDWARE CORP.**

(ESTABLISHED 1907 — INCORPORATED 1917)

1943 Pitkin Ave., Brooklyn 7, N. Y.

157 Snediker Ave., Brooklyn 7, N. Y.

Telephone - Dickens 2-1920

*Manufacturers of*

**SHIP AND BOAT EQUIPMENT  
NAVIGATION LIGHTS  
MARINE HARDWARE  
FOR ALL SIZES AND TYPES OF VESSELS**

THE "PERKO" MAIN OFFICE AND PLANT IN BROOKLYN, NEW YORK

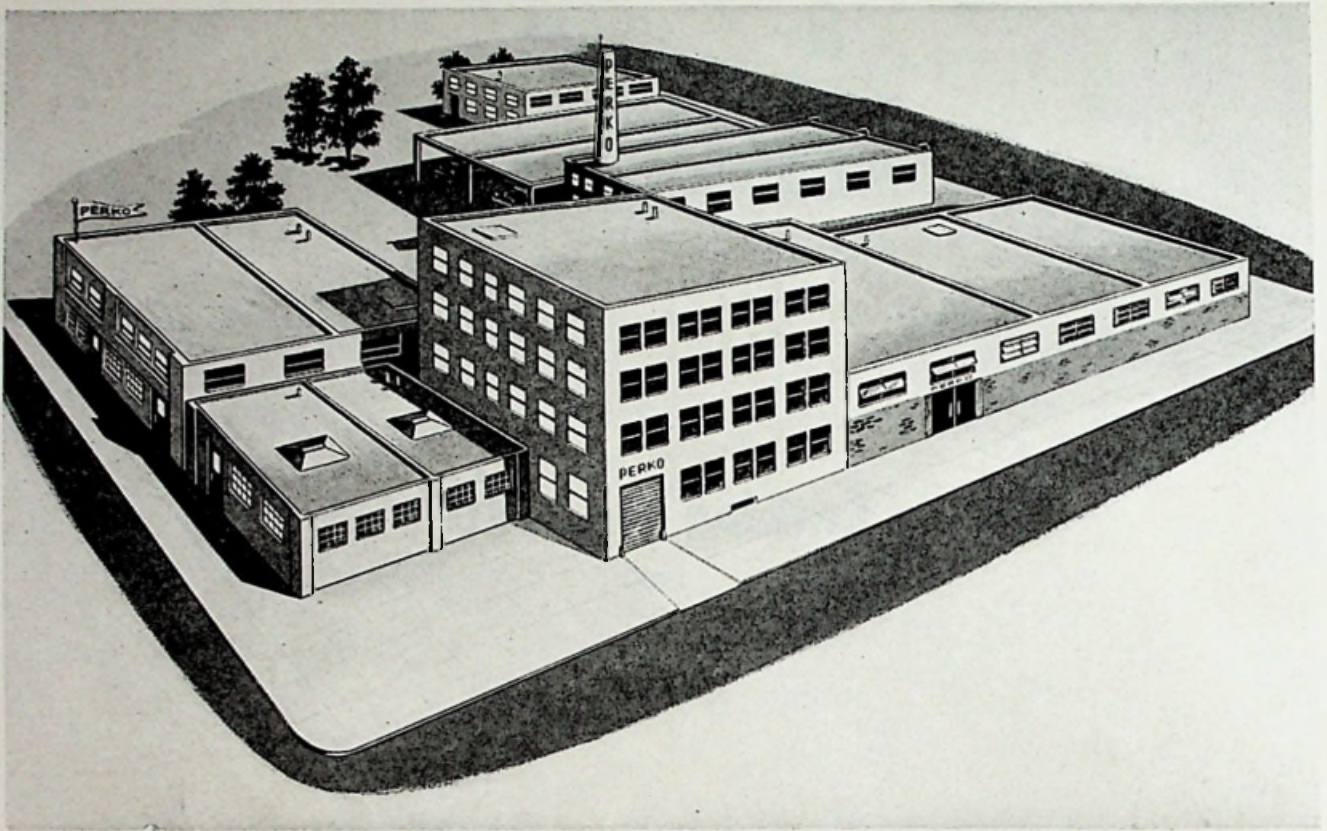

**BRANCH SALES OFFICES**

**MID - WEST AREA**

Eastern Division

P.O. Box 3032  
Buffalo 5, N. Y.  
43 Ernst St.  
Rochester, N. Y.  
2501 Cheltenham Road  
Toledo, Ohio

Central Division

110 E. Madison St.  
South Bend 1, Indiana  
1316 Carlisle Place  
Deerfield, Ill.

Western Division

P.O. Box 8115  
Plaza Sub-Station  
Kansas City 12, Mo.  
1801 Colfax Ave. So.  
Minneapolis 5, Minn.

**PACIFIC COAST AREA**

51 Fremont St.  
San Francisco 5, Cal.  
2902 Pacific Coast Hwy.  
Newport Beach, Cal.  
838 West 400 North  
Provo, Utah  
909 Western Ave.  
Seattle 4, Wash.

**CENTRAL AMERICA AREA**

Charles S. Abernathy  
P.O. Box 3501  
Panama, Rep. De Panama

**CARIBBEAN AREA**

Jose Campos  
P.O. Box 3286  
Malecon, San Juan  
Puerto Rico

**NEW ENGLAND AREA**

51 Upland Way  
Barrington, R. I.

**GULF COAST AREA**

1005 - 13 Magazine St.  
New Orleans 13, La.  
Office No. 138  
5526 Dyer St.  
Dallas, Texas

**SOUTHERN AREA**

P.O. Box 1699  
Fort Lauderdale, Fla.  
1203 No. 67 St. W.  
Bradenton, Fla.

**CUBA**

M. M. Bustamante  
Calle O. No. 157  
Vedado, Habana, Cuba

# The **PERKO** Plant

*Manufacturers of*  
QUALITY  
MARINE EQUIPMENT



Section of Shipping Dept., experienced in handling large volume of traffic efficiently.



A view of Perkins' Machine Shop, with latest equipment operated by expert craftsmen.

Polishing and Grinding Dept. responsible fo Perkins' high quality standards.



Tinsmith Dept., which produces Perko ship lights, searchlights, etc.



Part of Plating Dept., which produces Perkins fine finishes.



Partial view of Sheet Metal Press Dept., equipped to handle any job.





**LOUIS E. PERKINS**  
PRESIDENT



**FREDERICK PERKINS**  
FOUNDER



**WM. J. MURPHY**  
VICE PRESIDENT AND  
GEN'L SALES MANAGER



**MARVIN S. PERKINS**  
SECRETARY



**NATHAN LIPPMAN**  
TREASURER



**EMILY MANDELION**  
SALES DEPARTMENT



**ALBERT E. PERSKY**  
PLANT SUPERINTENDENT

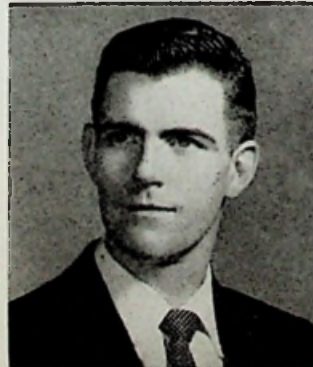

**JOHN P. RUSH**  
ASST. SALES MANAGER

# Perko

DISTRICT SALES  
MANAGERS IN  
THE UNITED STATES  
AND ADJACENT  
AREAS



**ROLAND E. McCUNE**  
California, Nevada,  
Utah, Colorado, Arizona,  
Wyoming, Southern Idaho,  
New Mexico, Hawaii



**JOHN B. MERIFIELD**  
Washington, Oregon,  
Northern Idaho, Montana,  
Alaska, British Columbia,  
Alberta, Saskatchewan,  
Manitoba



**FELIX F. TRANCHINA**  
Gulf Coast States  
Alabama to Texas  
and Tennessee



**HERBERT M. HILL, JR.**  
New York State, Ohio,  
Western Pennsylvania,  
West Virginia, Michigan



**ARTHUR J. THOMPSON**  
Illinois, Indiana  
Kentucky, Wisconsin



**W. WM. GRAHAM**  
Minnesota, Iowa  
Missouri, Arkansas,  
Oklahoma, Kansas,  
Nebraska, The Dakotas



**EDWARD W. OWENS**  
New England States



**HENRY S. GARTNER**  
Florida, Georgia,  
North and South Carolina



**MARIO M. BUSTAMANTE**  
Cuba



**JOSE L. CAMPOS**  
Puerto Rico - Virgin Islands



**CHARLES S. ABERNATHY**  
Panama

## FOREWORD AND GENERAL INFORMATION

**This catalog** has been arranged for convenient reference by grouping the material according to its application in the marine field.

You will find illustrated herein a number of new items added to our fast growing line, indicating constant attention to changes in the marine field, our determination to keep abreast of the times and to retain the ability to supply the most desirable and modern equipment.

Of course we continue our strictest rules of adherence to highest quality and finish, fastest possible delivery and cooperation with our numerous friends and customers throughout the world.

### PRICES AND TERMS

Our costs are subject to change due to causes beyond our control. The prices listed herein are only intended for guidance of our jobbers and do not necessarily establish resale prices. Applicable governmental regulations, shipping costs and other complications must be considered in arriving at a fair price. I.E. In areas west of the Mississippi, prices are generally 10% to 15% higher because of the heavy shipping cost involved. **All prices are subject to change without notice** and are F.O.B. New York, unless quoted otherwise. Terms are 30 days net; 2% if payment is sent 10 days from date of invoice.

### GUARANTEE

Every item bearing our trade-mark is guaranteed free from defects at time of shipment. In case of defects, adjustments will gladly be made, provided the material is returned to our factory and repairs have not been attempted by other than our own workmen.

### RETURN GOODS

**Material made to order is not returnable. Stock material is only returnable when permission has been granted by us, and is subject to a handling and refinishing charge. Shipping charges must be prepaid.**

### WEIGHTS

The weights given in this catalog are not guaranteed, but have been carefully determined and should be sufficient for general purposes.

### RATING

Orders from firms unknown to us and having no satisfactory commercial credit rating must be accompanied by cash or satisfactory references. C.O.D shipments will be made if a 25% deposit is sent with order.

### SHIPPING INSTRUCTIONS

Customers should send specific shipping instructions, if this is not done, we will use our own judgment in selecting route.

### COPYRIGHT

This catalog including all of its illustrations, form and data is protected by copyright. Same may not be reproduced in other catalogs, circulars, leaflets, etc. without our written permission.



# The Federal Boating Act of 1958 (Highlights of the law and regulations)

## CG — 290 July 1, 1959

### OPTION No. 1

(a) Inboards, outboards, and auxiliaries under 26 feet in length, carry, as before, a combination red and green lantern forward and on all around white light aft; show, as before, both lights when running under power alone. Auxiliaries, if running under both sail and power, show both lights instead of just the all around white light. Also, auxiliaries, if running under sail alone, show the combination lantern instead of the all around white light.

(b) Inboards, outboards, and auxiliaries of 26 feet or more, but not more than 65 feet, in length, and under 40 gross tons in weight, carry, as before, a 20 point white light forward, an all around white light aft, and separate red and green sidelights; show, as before, each of these lights when running under power alone. Auxiliaries, if running under both sail and power, show each of these lights instead of just the sidelights. If running under sail alone, auxiliaries show, as before, the red and green sidelights and turn off the white lights.

### OPTION No. 2

In the case of Option 2, inboards, outboards and auxiliaries, under or over 26 feet in length, but not more than 65 feet in length, and under 40 gross tons in weight, carry either a combination lantern or separate red and green sidelights, a 20 point white light forward, and a 12 point white light at the stern; show each of these lights when running under power alone or both sail and power. Auxiliaries, if running under sail alone, turn off the 20 point white light and show the sidelights (or combined lantern) and the 12 point white stern light.

Pertinent details for inboards, outboards, and auxiliaries subject to the Motorboat Act which exercise Option 2 are to be found in Rules 2 (a), 7 (a), 7 (b), and 10 (a) of the Regulations for Preventing Collisions at Sea, 1948, commonly referred to as International Rules. When checking the characteristics of the lights and their required separation, if the boat is less than 40 gross tons, Rules 7 (b), 7 (a), and 10 (a) should be read and applied in the order listed in this sentence, and Rule 2 (a) omitted.

**Option No. 1 Lights are Legal on Inland Waters, Western Rivers, and The Great Lakes only. Visibility requirements, Sidelights 1 Mile. Bow and Stern Lights 2 Miles.**

**Option No. 2 are New International Rule Lights legal anywhere, Inland Waters, Lakes, or High Seas. Visibility requirements, Sidelights 1 Mile. Bow and Stern Lights 3 Miles.**

## SAFETY EQUIPMENT

		INBOARDS, OUTBOARDS, OR AUXILIARIES		
		POWER ALONE	SAIL & POWER	SAIL ALONE
INLAND	Under 26'			
	26' or over not more than 65'			
INTERNATIONAL RULES	Power vessel under 40 gross tons and sail vessels under 20 gross tons*	<p style="text-align: center;">OR</p>	<p style="text-align: center;">OR</p>	
	Lights under International Rules may be shown on inland waters, western rivers, and Great Lakes, and are required on the high seas.			

\* Under International Rules powerboats of 40 gross tons or over must carry separate sidelights, visible 2 miles, and a 20-point white light visible 5 miles. Sailing vessels of 20 gross tons or over must carry separate side lights, visible 2 miles. Under sail, only boats of less than 20 tons may use a combination lantern. (Note: A vessel under sail alone on the Great Lakes is not required to display a stern light.)

**LIGHTS REQUIRED ON BOATS UNDERWAY BETWEEN SUNSET AND SUNRISE**  
**ANCHOR LIGHTS.** Vessels at anchor must display anchor lights except those of not more than 65 feet in length in a "special anchorage area."



NEW DESIGNS FOR 1960

The  
"Celebrity"

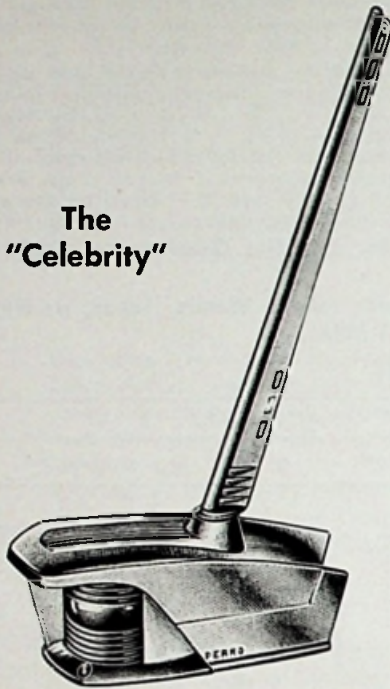

Fig. 1205

COMBINATION BOW LIGHTS

Zamak Die Castings

CHROMIUM PLATED

Red and Green Fresnel Lenses

Double Contact Electric Socket

The Flag Staff Socket is removable  
to permit quick rebulbing.

EACH \$8.25\*

Height Inches	Length Base Inches	Width Base Inches	Height Lens Inches	Weight Pounds
3¼	7	3¼	2½	1½

\*Price does not include flag staff, see Fig. 1230 Page 16.

COMBINATION BOW LIGHTS

ALL BRASS — CHROMIUM PLATED

Red and Green Fresnel Lenses

Double Contact Electric Socket

The Flag Staff Socket is removable  
to permit quick rebulbing

EACH \$8.00\*

Height Inches	Length Base Inches	Width Base Inches	Height Lens Inches	Weight Pounds
3¼	7¾	4¼	2½	1¼

\*Price does not include flag staff, see Fig. 1230 Page 16.

The  
"Salty"

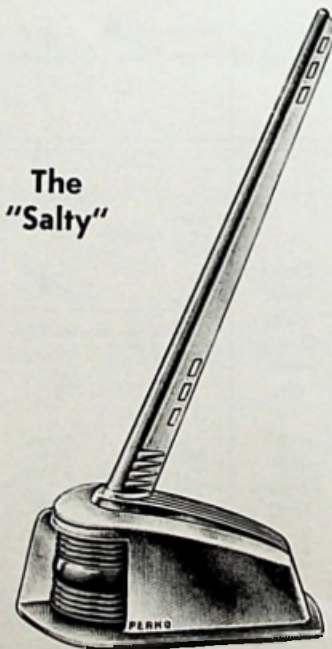

Fig. 1160

Spare Lenses See Fig. 259 CL. A-P

Spare Electric Sockets, \$.75 Each.



The "Ranger"

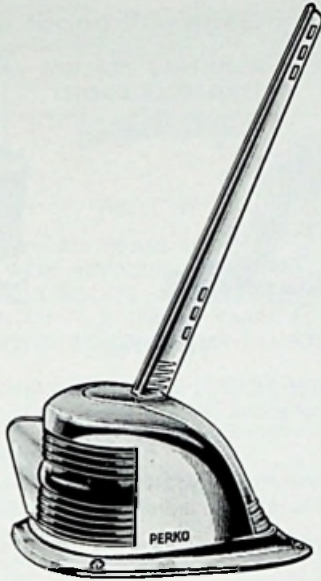

Fig. 1218

Combination Bow Lights  
FOR SMALL MOTOR BOATS

Zamak Die Castings  
CHROMIUM PLATED

Red and Green Fresnel Lenses  
Double Contact Electric Sockets

The "Aristocrat"

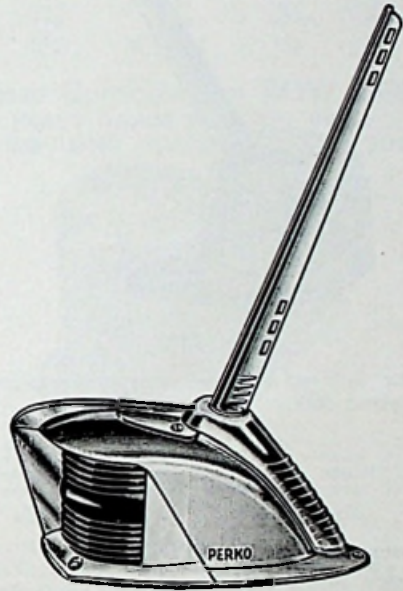

Fig. 1274

The Improved "Rocket"

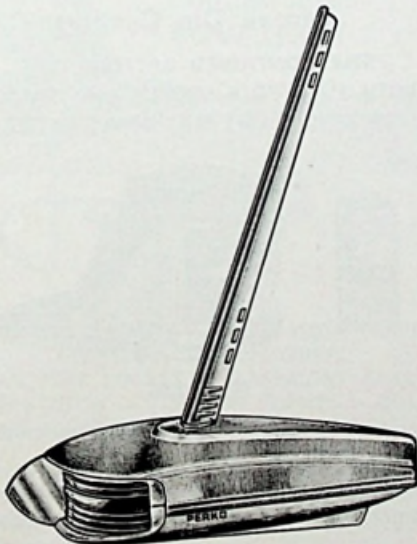

Fig. 1260

IMPROVEMENT — Height has been reduced  
to bring body of light closer to the deck.

Fig.	Light Each	Height Inches	Size Base Inches	Length Overall Inches	Height Lens Inches	Flagpole Socket Inches	Weight Pounds
1218	\$6.85	3½	6¼x3¾		2½	¾	¾
1274	8.00	3¾	7¼x3¾		2½	¾	1½
1260	8.00	2¾		9¾	1½	¾	1½

Flag Staff Fig. 1230 - \$3.00 each

For details see page 16

SPARE PARTS

Spare Lenses for Figs. 1218 and 1274 see Fig. 259 CL. A-P

Spare Lenses for Fig. 1260 see Fig. 259 Class A, Rocket.

Spare Electric Sockets \$.75 each.



## COMBINATION BOW LIGHTS

FOR SMALL MOTOR BOATS

**Zamak Die Casting**  
WITH REBULBING FEATURE AND  
FLAG POLE SOCKET

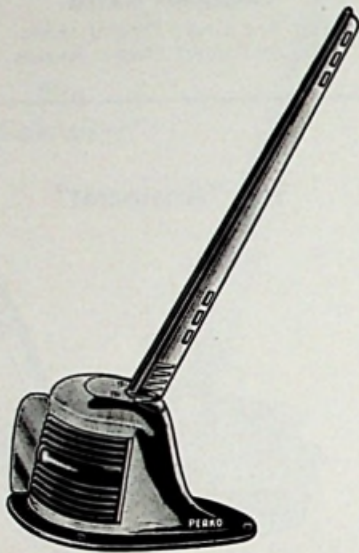

Fig. 1232

Complete with red and green fresnel lenses and double contact electric socket.

Chromium Plated Each	Height Inches	Size Base Inches	Height Lens Inches	Flag Pole Socket Inches	Weight Pounds
\$6.85	3 1/4	6 1/2 x 3 3/8	2 1/2	3/4	1

Spare Lenses, see Fig. 259, CL A-P.

Spare Electric Socket \$.75 ea.

Price does not include flag staff, see Fig. 1230.

### "Little Joe"

ZAMAK DIE CASTING — CHROMIUM PLATED

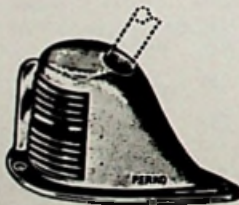

Fig. 1146

Has integral chromium plated color divider and angle flag pole socket. Complete with bulb.

Chromium Plated Each	Height Inches	Base Inches	Height Lens Inches	F. P. Socket Inches	Weight Ounces
\$4.25	2 1/4	4 1/2 x 2 3/8	1 3/8	1/2	7

Spare Miniature Bayonet Socket, Each \$.55.

Spare Lenses, see Fig. 259 Class A-L.J. Each \$1.10.

Flag Pole, see Figs. 495 and 496 Size No. 1.

**Heavy Gauge Wrought Brass**

WITH REBULBING FEATURE AND  
FLAG POLE SOCKET

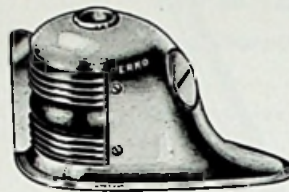

Rear view showing method of changing bulb

Fig. 1140

Complete with red and green fresnel lenses and double contact electric socket.

Height Inches	Base Inches	Height Lens Inches	Flagpole Socket Inches	Weight Pounds
3 1/4	3 3/4 x 6 1/4	2 3/8	3/4	1
Bright Brass Each	Polished Brass Each	Chromium Plated Each	Spare Lenses Each	Spare Sockets Each
\$5.95	\$7.50	\$8.25	\$1.70	\$.60

Spare D.C. Sockets, see Fig. 747, No. 1

Spare Lenses, see Fig. 259, Class A Standard.

Spare Rebulbing Feature Complete, Polished \$2.50, Chrome \$3.00 Each.

**Zamak Die Casting**

SELF CONTAINED BATTERY TYPE  
WITH FLAG POLE SOCKET AND CARRY  
FOR SINGLE CELL FLASHLIGHT BATTERY

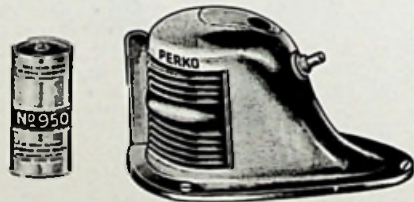

Fig. 1236

Battery and bulb easily replaced by removal of three screws from base.

With red and green fresnel lenses, miniature socket and bulb. Zamak die cast body. Battery not included.

Chromium Plated Each	Height Inches	Size Base Inches	Height Lens Inches	Flag Pole Socket Inches	Weight Pounds
\$9.50	3 1/4	6 1/4 x 3 3/8	2 1/2	3/4	1 1/4

Spare Lenses, See Fig. 259, CL. A-P.

Spare Miniature Bayonet Socket and Switch Assembly for Fig. 1236, \$1.25 each.

Spare Bulb — See Fig. 337 No. 351.



**Brass "2 in 1"  
Combination  
BOW LIGHT**

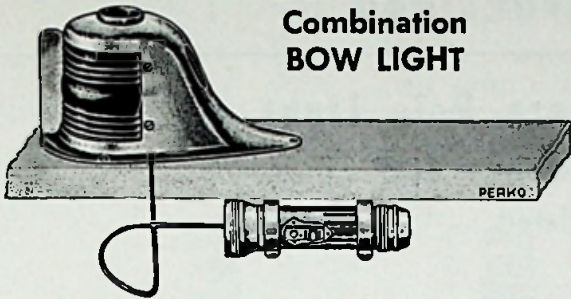

Fig. 1147

**ALL BRASS LIGHT  
WITH REBULBING FEATURE  
FLAG POLE SOCKET — FLASHLIGHT CASE  
WITH SWITCH — 2 SPRING CLAMPS — BULB  
ALL WIRED READY FOR INSTALLATION**

In addition to a very practical and attractive navigation light, the user has a 2 cell flashlight available and handy at all times as the flashlight case is complete with reflector for light projection.

Supplied with 4 feet of wire to permit location of flashlight case at most convenient spot. Lamp socket is miniature screw type.

Batteries are not included.

Height Light Inches	Base Light Inches	Height Lens Inches	Flag Pole Socket Inches	Weight Pounds
3 3/4	3 3/4 x 6 1/4	2 5/8	3/4	1 1/2
Chromium Plated Each		Spare Lenses Each	Spare Bulbs Each	
\$13.25		\$1.70	\$.25	

**Zamak "2 in 1"  
Combination  
BOW LIGHT**

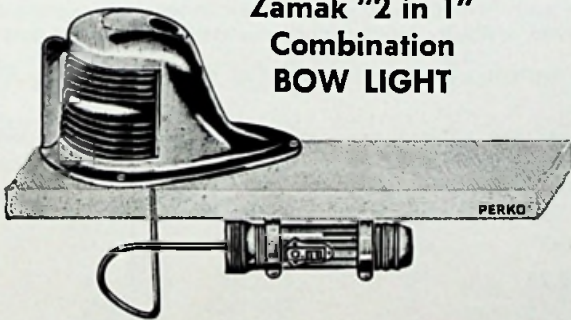

Fig. 1235

**ZAMAK DIE CASTING — CHROMIUM PLATED  
WITH REBULBING FEATURE  
FLAG POLE SOCKET — FLASHLIGHT CASE  
WITH SWITCH — 2 SPRING CLAMPS — BULB  
ALL WIRED READY FOR INSTALLATION**

Supplied with 4 feet of wire to permit location of flashlight case at most convenient spot. Lamp socket is miniature screw type.

Batteries are not included.

Chromium Plated Each	Height Light Inches	Base Light Inches	Height Lens Inches	Flag Pole Socket Inches	Weight Pounds
\$10.25	3 3/4	6 1/4 x 3 3/4	2 1/2	3/4	1 1/2

Spare Lenses for Fig. 1147 see Fig. 259 Class A Strd.  
Spare Lenses for Fig. 1235 see Fig. 259 Class A-P.

Spare 2 in 1 Battery Light Assemblies consisting of Flashlight, Holders, Cable and Lamp Socket, per set \$4.25

**"Little Joe" "2 in 1"  
Combination  
BOW LIGHT**

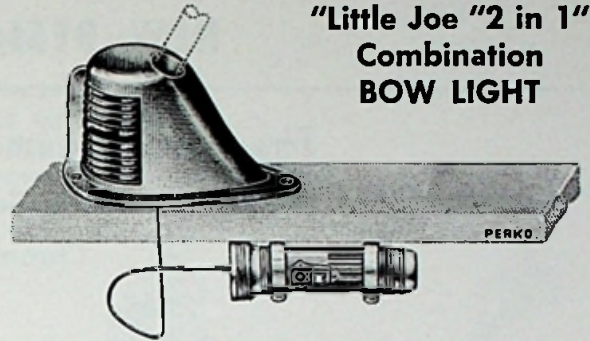

Fig. 1247

**ZAMAK DIE CASTING — CHROMIUM PLATED  
WITH FLAG POLE SOCKET — FLASHLIGHT HOLDER  
WITH SWITCH — 2 SPRING CLAMPS  
BULB—WIRED READY FOR INSTALLATION**

Chromium Plated Each	Height Light Inches	Base Light Inches	Height Lens Inches	F. P. Socket Inches	Weight Ounces
\$7.50	2 1/4	4 1/2 x 2 3/8	1 1/8	1/2	15

**Cruiser Combination BOW LIGHT  
HEAVY GAUGE WROUGHT BRASS  
WITH REBULBING FEATURE AND F. P. SOCKET**

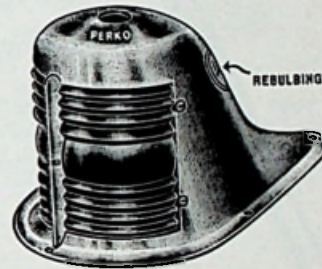

Fig. 1141

Polished Brass Each	Chromium Plated Each	Height Inches	Base Inches	Height Lens Inches	F. P. Socket Inches	Weight Pounds
\$14.00	\$16.50	5 1/8	5 5/8 x 9 1/2	4 1/4	1	2

Spare Lenses, Each \$3.45.

Spare D.C. Sockets, see Fig. 747 No. 7 Each \$.90.

Spare Rebulbing Feature Complete, Polished Each, \$2.50

Chromium Plated, Each \$3.00.

**Combination BOW LIGHT  
For Sail Boats  
WROUGHT BRASS — ELECTRIC**



Fig. 1144

For mounting on forward part of mast. Complete with red and green fresnel lenses and double contact electric socket.

Polished Brass Each	Chromium Plated Each	Height Overall Inches	Diam. Body Inches	Height Lens Inches	Weight Pounds
\$4.75	\$6.00	4 1/2	2 1/2	2 3/8	3/4



**NEW DESIGNS FOR 1960**

**The "Tru-Beam" Stern Pole Light**

Zamak Die Casting — Brass Pole

Chromium Plated

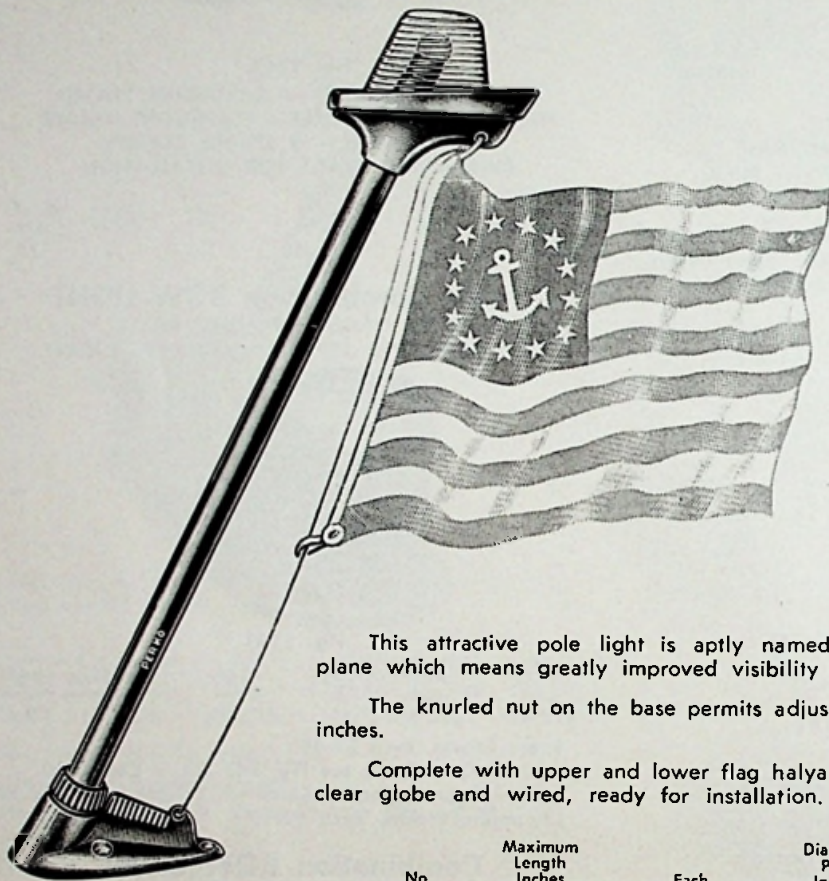

**Fig. 1206**

This attractive pole light is aptly named as the light is projected on a horizontal plane which means greatly improved visibility for the most important light on the boat.

The knurled nut on the base permits adjusting the height of the light down to 4 3/8 inches.

Complete with upper and lower flag halyard eyes, double contact electric socket, clear globe and wired, ready for installation.

No.	Maximum Length Inches	Each	Diameter Pole Inches	Dimensions Base Inches	Weight Pounds
1	20	\$ 9.25	3/4	4 5/8 x 1 3/4	1 1/8
2	24	9.75	3/4	4 5/8 x 1 3/4	1 3/8
3	30	10.35	3/4	4 5/8 x 1 3/4	1 3/4
4	36	10.95	3/4	4 5/8 x 1 3/4	2

Flag Pole Socket only \$3.50 each — Spare Electric Sockets, \$.85 each  
Spare Globes, see Fig. 281-P.

**INTERNATIONAL SHIELDS**

HEAVY GAUGE PLASTIC

TO PERMIT USE OF FIG. 1206 ON INTERNATIONAL WATERS



**Fig. 476**



**Fig. 478**

**FIG. 476 SHIELDS LIGHT TO 225 DEGREES**

**FIG. 478 SHIELDS LIGHT TO 135 DEGREES**

**EACH \$.90**



## Adjustable Pole Lights

CHROMIUM PLATED

ALL WIRED — READY FOR INSTALLATION

POLE IS 3/4 INCH OUTSIDE DIAMETER HEAVY GAUGE BRASS TUBING

ELECTRIC SOCKETS ARE ALL BAYONET DOUBLE CONTACT

ALL ADJUSTABLE TO VARIOUS LENGTHS DOWN TO 4 3/4 INCHES



Fig. 605

ALL BRASS



Fig. 1233

BRASS POLE AND  
GLOBE HOLDER  
ZAMAK BASE



Fig. 1293

BRASS POLE  
ZAMAK GLOBE  
HOLDER AND BASE



Fig. 1276

BRASS POLE AND  
GLOBE HOLDER  
ZAMAK BASE

Size No.	Maximum Length Inches	Fig. 605 Each	Fig. 1233 Each	Fig. 1293 Each	Fig. 1276 Each	Dimensions Base Inches		Pounds
						605 1233 1293	1276	
1	20	\$ 9.50	\$7.75	\$ 8.00	\$ 8.50	3 3/8 x 2 1/2	4 3/8 x 1 3/4	1 1/8
2	24	10.00	8.25	8.50	9.00	3 3/8 x 2 1/2	4 3/8 x 1 3/4	1 1/4
3	30	10.60	8.85	9.10	9.60	3 3/8 x 2 1/2	4 3/8 x 1 3/4	1 3/8
4	36	11.20	9.45	9.70	10.20	3 3/8 x 2 1/2	4 3/8 x 1 3/4	1 3/4

Spare Globes — For Figs. 605 and 1233 see Fig. 248-P and for Figs. 1276 and 1293 see Fig. 281-P.

Spare Electric Sockets — For above \$.85 each.

Spare Flag Pole Socket — For Figs. 605 and 1276 \$3.50 each, for Figs. 1233 and 1293, \$2.00 each.



Fig. 247

Pole Lights Figs. 605 and 1233 can be supplied with Fig. 247 vertical ribbed globe illustrated. If desired, be sure to specify.

## INTERNATIONAL SHIELDS

HEAVY GAUGE PLASTIC

To permit use of above pole lights on international waters

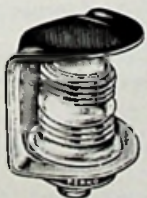

225° Bow Shield  
Fig. 507

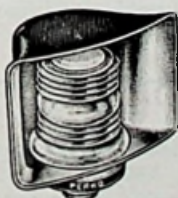

135° Stern Shield  
Fig. 508

For use with Figs. 422, 605, 1233 and all other lights using the 1 1/4 inch or 2 1/2 inch globe.

Each \$1.25



225° Bow Shield  
Fig. 462



135° Stern Shield  
Fig. 463

For use with Figs. 421, 1276 and 1293.

Each \$.90

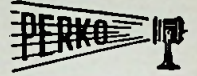

## New Removable POLE LIGHT

ALL BRASS—CHROMIUM PLATED  
1 3/4 INCH GLOBE—3/4 INCH TUBING



Fig. 1209

Instantly removable for stowing away, without breaking connections.

Electric socket permanently fixed in deck socket, the connector is within the tubular pole. Push pole into deck socket and electric connections are made. Two prong type connector, no springs.

No.	Length Overall Inches	Each	Dimensions Base Inches	Weight Pounds
1	20	\$11.00	3 3/8 x 2 1/4	7/8
2	24	11.50	3 3/8 x 2 1/4	1
3	30	12.10	3 3/8 x 2 1/4	1 1/4
4	36	12.70	3 3/8 x 2 1/4	1 1/2

## New Swivel Type POLE LIGHTS

ALL BRASS—CHROMIUM PLATED  
1 3/4 INCH GLOBE—3/4 INCH TUBING

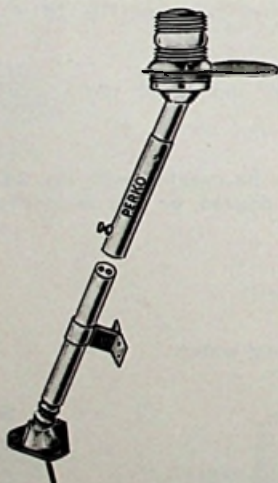

Fig. 660

For mounting and fastening to deck and center post of flying bridge windshield. Swivel base permits adjustment to any normal angle. Complete with glare shield.

No.	Length Overall Inches	Each	Weight Pounds
2	24	\$13.25	1
3	30	13.85	1 1/4
4	36	14.45	1 1/2

## Transom POLE LIGHT

ALL BRASS—CHROMIUM PLATED  
1 3/4 INCH FRESNEL GLOBE

DOUBLE CONTACT ELECTRIC SOCKET

COMPLETE WITH CORK GASKET  
AND  
WIRED READY FOR INSTALLATION  
DIAM. POLE 3/4 INCH



Fig. 687

No.	Dimensions of Bracket Inches	Weight Pounds
1	2 1/4 x 3/4	7/8
2	2 1/4 x 3/4	1
3	2 1/4 x 3/4	1 1/8
4	2 1/4 x 3/4	1 1/4

No.	Length Overall Inches	Each
1	20	\$ 8.75
2	24	9.25
3	30	9.85
4	36	10.45

For mounting on transom, with adjustable brackets.

## Adjustable POLE LIGHT

HIGH INTENSITY

1 1/2 INCH FRESNEL BALL GLOBE

BRASS POLE  
BRONZE BASE  
D.C. SOCKET, WIRED  
COMPLETE WITH CONNECTORS  
DIAM. POLE 3/4 INCH



Fig. 609

No.	Weight Pounds
1	1 1/4
2	1 1/3
3	1 1/2
4	1 3/4

No.	Maximum Length Inches	Chromium Plated Each
1	20	\$11.00
2	24	11.50
3	30	12.10
4	36	12.70

Flag Pole Socket Complete ..... \$3.50 each

Adjustable to various lengths down to 5 inches. Knurled nut holds pole firmly in place.

### NOTES

Spare globes for Figs. 660, 687 and 1209. See Fig. 248-P.

Spare globes for Fig. 609, see Fig. 604.

Spare electric sockets for all above, \$.85 each.

Figs. 660, 687 and 1209 can be supplied with vertical ribbed globe as illustrated with Fig. 687; please specify.



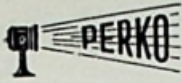

2½ OR 3 INCH GLOBE, FIG. 250 OR 251  
 COMPLETE WITH FLAG POLE SOCKET AND  
 ELECTRIC CONNECTIONS IN POLE AND SOCKET  
 HOLLOW MAHOGANY POLE—VARNISHED



**Improved  
 POLE  
 LIGHT  
 ASSEMBLY**



With vertical ribbed globe (illus-  
 trated) specify Fig. 531-A.

Fig. 531

Insert pole in socket and electric connection is complete. No wires exposed, no springs to corrode. A real positive hook-up, unaffected by water or corrosion.

Pole may remain in socket at all times, no switch necessary. Female part of connector in base of pole has four holes, two for "on" position, two for "off" position. Male part of connector in flag pole socket has two prongs (no springs). To light, loosen thumb screw, lift pole, give half turn and reset. To disconnect, reverse operation.

Length Pole Inches	Chromium Plated Each	Diam. Base of Pole Inches	Weight Pounds
24	\$18.25	1 ¼	2
30	19.25	1 ¼	2 ½
36	20.25	1 ¼	2 ¾
48	21.25	1 ¼	3

Spare clear globes . . . . . Each \$1.90  
 Spare electric bulb sockets Fig. 747, No. 2 . . Each .60  
 Electric connectors only (male & female) . . . per set 1.20  
 Complete except F. P. socket, deduct . . . . . Each 2.00  
 With Red or Green globe, add . . . . . Each .60  
 Furnished with 2½ inch globe unless otherwise specified.

**HIGH INTENSITY**  
 COMPLETE WITH SOCKET AND ELECTRIC  
 CONNECTIONS IN POLE AND SOCKET  
 MAHOGANY POLE—CAST BRONZE SOCKET



**Junior  
 POLE  
 LIGHT  
 ASSEMBLY**

Fig. 1145

Wired through hollow center of pole. Globe will take a 6 C. P. bulb, double contact. Base of pole is 1 inch.

Length Pole Inches	Chromium Plated Each	Weight Pounds
24	\$11.00	1 ½
30	11.75	1 ¾

Complete except F. P. socket, deduct . . . . . Each \$1.00  
 Spare clear globes, Fig. 604 . . . . . Each 1.25  
 Spare electric bulb sockets, Fig. 747, No. 2 . . . Each .60  
 Electric connectors only (male & female) . . . per set 1.20

**"Little Joe" POLE LIGHT  
 HIGH INTENSITY**



Fig. 625

1½ INCH FRESNEL BALL GLOBE  
 POLISHED ALUMINUM  
 DOUBLE CONTACT ELECTRIC  
 SOCKET

An attractive companion for our "Little Joe" combination light, Fig. 1146.

Pole is adjustable to various lengths down to 5 inches.

**WIRED READY FOR INSTALLATION**

Length Overall Inches	Each	Diam. Pole Inches	Weight Ounces
20	\$7.50	¾	10
24	7.75	¾	11

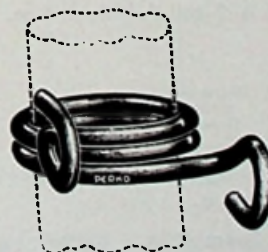

Fig. 232

**Halyard Eyes**  
 For Metal Flag Poles  
 SPRING BRASS—  
 CHROMIUM PLATED

For quick attachment of flag to pole. Adjustable to various diameters.

Each—\$.30



**"2 in 1"  
Adjustable Flag POLE LIGHTS**

**HIGH INTENSITY  
WITH 1 1/2 INCH FRESNEL  
BALL GLOBE. ALL BRASS  
WITH STREAMLINE BASE.  
COMPLETE AS ILLUSTRATED  
—WITH BULB.**

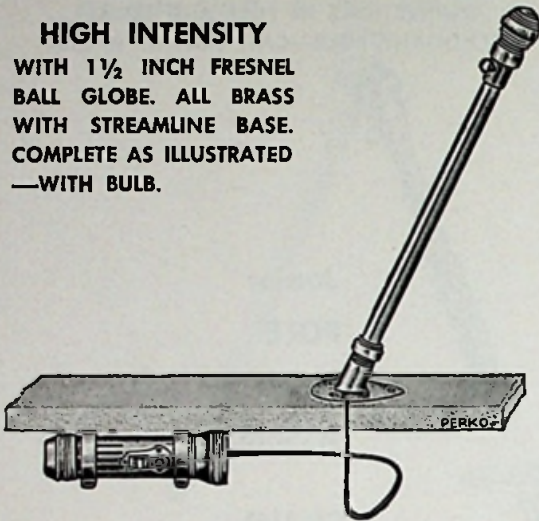

Fig. 1148

This is our popular Fig. 609 pole light supplied with a 2 cell flashlight case, mounting clamps and wire.

Batteries are not included.

Maximum Length Inches	Chromium Plated Each	Diameter Pole Inches	Weight Pounds
20	\$14.00	3/4	1 3/4
24	14.50	3/4	1 7/8

Spare Clear Globes Fig. 604 ..... \$1.25 Each  
Spare Bulbs ..... .25 Each

**WITH 1 3/4 INCH FRESNEL  
GLOBE. BRASS POLE —  
STREAMLINE ZAMAK BASE  
COMPLETE AS ILLUSTRATED  
WITH BULB.**

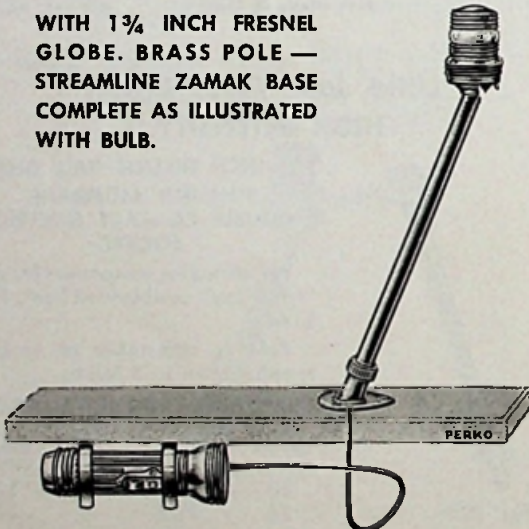

Fig. 1239

Our Fig. 1233 Pole Light with a 2 cell flashlight case, mounting clamps and wire.

Batteries are not included.

Maximum Length Inches	Chromium Plated Each	Diameter Pole Inches	Weight Pounds
20	\$11.00	3/4	1 1/2
24	11.50	3/4	1 5/8

With vertical ribbed globe specify Fig. 1239-A.

Spare 2 in 1 Battery Light Assemblies consisting of Flashlight, Holders, Cable and Lamp Socket, per set \$4.25

**FLAG STAFF  
ULTRA MODERN DYNAFORM TAPER DESIGN  
ZAMAK DIE CAST—CHROMIUM PLATED**



Fig. 1230

Neoprene Rubber "O" Ring in base for holding in Flag Pole socket.

Each	Length Overall Inches	Diameter Base Inches	Weight Ounces
\$3.00	14	3/4	8

**FLAG STAFF  
MAHOGANY**

Turned from solid seasoned mahogany. Varnished, hand rubbed polished finish.

No.	Each	Length Overall Inches	Diam. Base Inches	Weight Ounces
1	\$1.85	14	1/2	1
2	2.20	14	3/4	1 1/2
3	2.40	18	3/4	2 1/2
4	2.55	18	1	4
5	4.15	24	1	5
6	5.25	30	1 1/4	8 1/2
7	7.00	36	1 1/4	13
8	8.75	48	1 1/4	26

With brass ferrule, add \$.75 Each.



Fig. 496

**FLAG STAFF**

**BRASS — CHROMIUM PLATED**

With eyes for flag halyard and rubber "O" ring for firm fit in socket. Size No. 1 fits combination Bow Light Fig. 1146. Size No. 3 Figs. 1140, 1147, 1160, 1205, 1218, 1232, 1235, 1236, 1274 and 1260.

No.	Each	Length Overall Inches	Diam. Base Inches	Weight Ounces
1	\$3.20	14	1/2	2
2	3.40	14	3/4	3
3	3.50	18	3/4	6

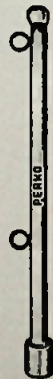

Fig. 495



## POLE LIGHTS

BRASS—WITH CLEAR THREADED FRESNEL GLOBE  
DOUBLE CONTACT ELECTRIC SOCKET



Fig. 491  
Standard  
Type



Fig. 247



Fig. 248-P

See Note At  
Bottom Of Page



Fig. 600  
High  
Intensity  
Type

Fig.	No.	Chromium Plated Each	Spare Globes Each	Diameter Globe Inches	Height Overall Inches	I.D. Neck Inches	Maximum Bulb C.P.	Weight Ounces
491	1	\$6.50	\$1.90	2 1/2	5	3/4	50	12
	2	6.50	1.90	3	5 3/4	3/4	50	14
600		6.00	1.25	1 1/2	4 1/4	5/8	6	7

## STERN LIGHTS

BRASS—WITH CLEAR THREADED FRESNEL GLOBE  
DOUBLE CONTACT ELECTRIC SOCKET



Fig. 404  
High  
Intensity  
Type



Fig. 422  
Standard  
Type



Fig. 438  
Standard  
Streamline  
Type



Fig. 421  
Tru-Beam  
Streamline  
Type

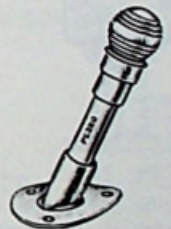

Fig. 439  
High Intensity  
Streamline  
Type

Fig.	No.	Polished Brass Each	Chromium Plated Each	Spare Globes Each	Diameter Globe Inches	Height Overall Inches	Size Base Inches	Maximum Bulb C.P.	Weight Ounces
404			\$6.50	\$1.25	1 1/2	3 1/2	2 3/8	6	7
422	1	\$6.25	7.00	1.90	2 1/2	6	2 3/8	50	12
	2	6.25	7.00	1.90	3	6 1/2	2 3/8	50	14
	3	7.75	8.75	1.90	3	12	2 3/8	50	20
438	1		7.50	1.90	2 1/2	6	3 3/8 x 2 1/4	50	13
	2		7.50	1.90	3	6 1/2	3 3/8 x 2 1/4	50	13
	3		9.25	1.90	2 1/2	12	3 3/8 x 2 1/4	50	20
	4		9.25	1.90	3	12 1/2	3 3/8 x 2 1/4	50	20
421			9.00	.95	2 3/8	12	3 3/8 x 2 1/4	6	17
439	1		8.50	1.25	1 1/2	6	3 3/8 x 2 1/4	6	11
	2		9.25	1.25	1 1/2	12	3 3/8 x 2 1/4	6	18

NOTE: Spare Globes, see Figs. 250, 251 and 604. With Red, Green or Blue Globes add \$.60 each.

Spare Globes, for Fig. 421, see Fig. 281-P, Clear only.

Figs. 422, 438 and 491 can be supplied with globe Fig. 247 or Fig. 248-P as illustrated above in clear only.  
For Globe, Fig. 247, add letter "A" to Fig. No., i.e. 422-A. For Globe, Fig. 248-P, add letter "B" to Fig. No.



## STERN LIGHTS

CAST BRONZE



Fig. 375

Equipped with 360 degree clear fresnel lens and double contact electric socket.

Any height desired can be secured by placing required length of 1 inch brass pipe at joint marked "A". These parts have standard 1 inch pipe thread.

Height Overall Inches	Diam. Base Inches	Diam. Body Inches	Height Lens Inches	Weight Pounds
7	3 1/2	3 1/2	3 3/8	2 3/4
Plain Bronze Each	Polished Bronze Each	Chromium Plated Each	Spare Lens Fig. 261 Each	Spare Socket Fig. 747 Each
\$14.95	\$16.25	\$18.50	\$2.50	\$.60

With red, green, blue or amber lens, add \$1.50 each.

With medium screw socket fig. 346 for 15 watt bulb, add \$1.90 each.

## STERN LIGHTS

CAST BRONZE

WITH FIG. 106 THREADED GLOBE FOR BULB UP TO 60 WATTS



Fig. 112

Equipped with clear fresnel globe and fig. 222 No. 1 medium screw electric socket.

Height Overall Inches	Diam. Base Inches	Size of Globe Inches	Weight Pounds
8 3/4	3 1/8	5x3 1/2	3 3/4
Plain Bronze Each	Polished Bronze Each	Chromium Plated Each	
\$12.60	\$14.70	\$17.00	

Spare globes, \$3.60 each.

Spare sockets, \$ .90 each.

With red, green, blue or amber globe, add \$1.75 each.

With double contact socket fig. 276, No. 3 add \$.95 each.

## MEAL AND ABSENT LIGHTS

CAST BRONZE—WATERTIGHT

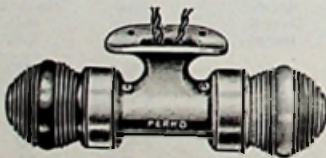

Fig. 329 with Double Contact Socket

Fig. 330 with Medium Screw Socket

For mounting on yardarm. Supplied with two fresnel globes, one blue, the other clear, Fig. 251.

Fig.	Polished Bronze Each	Chromium Plated Each	Length Overall Inches	Size Base Inches	Diam. Globe Inches	Wt. Lbs.
329	\$17.75	\$21.00	9	3 3/8 x 1 3/4	3	2
330	19.75	23.00	10	3 3/8 x 1 3/4	3	2 1/2

Bulbs for Fig. 329, see Fig. 337 all sizes listed.

Bulbs for Fig. 330, see Fig. 8 all sizes listed.

## MAST LIGHTS

CAST BRONZE



Fig. 521

Equipped with 360 degree clear fresnel lens and double contact electric socket. Extra long neck.

Height Overall Inches	Diam. Body Inches	Height Lens Inches	Inside Length Neck Inches	Inside Diam. Neck Inches	Weight Pounds
6 3/4	3 1/2	3 3/8	2 1/2	1 1/4	2
Plain Bronze Each	Polished Bronze Each	Chromium Plated Each	Spare Lens Fig. 261 Each	Spare Socket Fig. 747 Each	
\$13.65	\$14.70	\$16.50	\$2.50	\$.60	

With red, green, blue or amber lens, add \$1.50 each.  
With medium screw socket fig. 346 for 15 watt bulb, add \$1.90 each.

## MAST LIGHTS

CAST BRONZE

WITH FIG. 106 THREADED GLOBE FOR BULB UP TO 60 WATTS



Fig. 113

Equipped with clear fresnel globe and fig. 222 medium screw electric socket.

Height Overall Inches	Diam. Bottom Opening Inches	Inside Length Neck Inches	Size of Globe Inches	Weight Pounds
9	1 3/4	2 1/2	5x3 1/2	4
Plain Bronze Each	Polished Bronze Each	Chromium Plated Each		
\$13.40	\$15.75	\$18.40		

Spare globes, \$3.60 each.

Spare sockets, \$ .90 each.

With red, green, blue or amber globe, add \$1.75 each.

With double contact socket fig. 276, No. 3, add \$.95 each.

## MAST LIGHTS

CAST BRONZE—WITH THREADED GLOBE GUARD INTEGRAL CABLE ENTRANCE WITH TERMINAL TUBE



Fig. 83

With Fig. 106 Clear Threaded Globe for bulb up to 60 watts, medium screw socket.

Height Overall Inches	Diam. Bottom Opening Inches	Inside Length Neck Inches	Size of Globe Inches	Weight Pounds
10	1 3/4	2 1/2	5x3 1/2	5 1/2
Plain Bronze Each	Polished Bronze Each	Chromium Plated Each		
\$21.00	\$24.60	\$28.30		

Spare clear globes, \$3.60 each.

Spare guards, \$5.50 each.

Spare sockets, \$ .90 each.

With red, green, blue or amber globe add \$1.75 each.

With double contact socket fig. 276, No. 3, add \$.95 each.



## POLE OR MAST LIGHT

HEAVY BRASS  
THREADED FRESNEL GLOBE  
DOUBLE CONTACT SOCKET —  
FOR 1/2 INCH PIPE

Fig. 362

With 2 1/2 or 3 inch globe Fig. 250 or 251, will accommodate up to 50 C. P. bulb.

No.	Bright Brass Each	Polished Brass Each	Chromium Plated Each	Diam. Globe Inches	Height Overall Inches	Diam. Base Inches	Wt. Lbs.
1	\$7.00	\$8.00	\$8.75	2 1/2	3 1/2	2 3/8	1
2	7.00	8.00	8.75	3	4	2 3/8	1 1/2

With Red, Green, Blue or Amber Globe, Add \$.60 each.



Fig. 103

## MAST AND YARDARM LIGHTS



Fig. 104

CAST BRONZE—CLEAR FRESNEL GLOBE  
MEDIUM SCREW SOCKET—FOR 15 WATT BLUB

Fig 103 threaded for 1/2 inch pipe.

Fig. 104 for mounting on Truck or Yardarm.

Will accommodate 15 watt A-17 bulb.

Fig.	Burnished Bronze Each	Polished Bronze Each	Chromium Plated Each	Height Overall Inches	Diam. Globe Inches	Wt. Lbs.
103	\$ 9.20	\$11.25	\$13.40	6	3	2
104	10.25	12.90	14.95	5 5/8	3	2

With red or green globe, add \$1.10 each.

Spare clear globes fig. 249, \$2.65 each.

Spare sockets fig. 222, No. 1, \$.90 each.

With double contact socket fig. 276, add \$.95 each.



Fig. 488

## MAST LIGHTS

BRASS BASE  
CLEAR FRESNEL GLOBE  
MEDIUM SCREW SOCKET



Fig. 489

Fig. 488 threaded 1/2 inch I. P. S.

Fig. 489 drilled for mounting on mast truck.

Fig.	Burnished Bronze Each	Polished Bronze Each	Height Overall Inches	Diam. Base Inches	Size Globe Inches	Opening in Globe Inches	Wt. Lbs.
488	\$7.35	\$8.25	6	2 3/4	5 1/2 x 2 3/4	1 1/2	1

Chromium plated finish, add \$1.00 to polished price.

Spare clear globes fig. 77, \$2.40 each.

With red, green or blue globe, add \$1.10 each.

Spare electric sockets see Fig. 346 No. 1.

Bulbs for above, 120 volt 10 watt, clear \$.60 each.

## POLE or MAST LIGHT

HEAVY BRASS BASE—CHROMIUM PLATED  
I.D. OF NECK FOR 1 1/4" DIAMETER POLE OR MAST  
THREADED FRESNEL GLOBE  
BAYONET DOUBLE CONTACT SOCKET



Fig. 428

Chromium Plated Each	Diam. Globe Inches	Height Overall Inches	Diam. Base Inches	Wt. Ounces
\$7.00	2 1/2	4 1/4	1 1/4	7

Spare globes, see Fig. 248-P



Fig. 136

POLE OR MAST LIGHT  
CAST BRONZE  
THREADED FRESNEL GLOBE  
BAYONET DOUBLE CONTACT SOCKET  
FOR 1 1/2 INCH DIAMETER MAST

No.	Burnished Brass Each	Polished Brass Each	Chromium Plated Each	Diam. Globe Inches	Height Overall Inches	Diam. Base Inches	Wt. Lbs.
1	\$5.60	\$6.65	\$7.10	2 1/2	4	1 1/2	1

Spare globes, see fig. 250.

With Red, Green or Blue Globe, Add \$.60 each.



Fig. 145 with Guard

## MAST LIGHTS



Fig. 309 without Guard

CAST BRONZE—WITH MEDIUM SCREW SOCKET  
FIG. 106 CLEAR THREADED GLOBE—60 WATT

Fig.	Height Overall Inches	Size Globe Inches	Opening In Globe Inches	Tapped for Pipe Size Inches	Wt. Lbs.
145	7 3/8	5 x 3 1/2	2 3/4	1/2	3 3/4
309	6 1/2	5 x 3 1/2	2 3/4	1/2	2 1/2

Fig.	Burnished Bronze Each	Polished Bronze Each	Chromium Plated Each	Spare Clear Globes Each
145	\$15.20	\$17.30	\$20.45	\$3.60
309	10.25	12.00	14.00	3.60

With red, green, blue or amber globe, add \$1.35 each.

Spare medium screw sockets fig. 222 No. 1, \$.90 each.

With double contact socket fig. 276 No. 3, add \$.95 each.

Spare threaded brass guards, \$5.50 each.



## Perko "International" NAVIGATION LIGHTS

ZAMAK DIE CASTINGS — CHROMIUM PLATED — WATERTIGHT

Shielded to U.S.C.G. Visibility Requirements, Revised Rules of Motorboat Act.  
Effective June 4, 1956 — Public Law 552

Legal For All Types of Boats — Under 65 Feet in Length and Under 40 Gross Tons.  
For Use on Inland and International Waters.

ELECTRIC—DOUBLE CONTACT BAYONET TYPE SOCKETS  
NECK HAS 1/2 INCH FEMALE PIPE THREAD FOR MOUNTING ON PIPE  
Base Drilled for Wood Screws for Mounting Directly to Deck, Cabin Top and Cabin Sides.

### SIDE LIGHTS

10 POINTS — 112½ DEGREES  
VISIBILITY — 2 MILES  
COLORED LENSES — 1 RED AND 1 GREEN

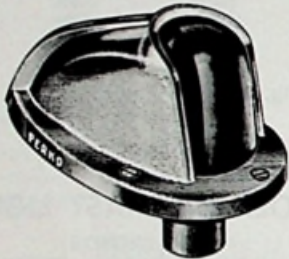

Fig. 1278

### Bow or Masthead Lights

20 POINTS — 225 DEGREES  
VISIBILITY 3 MILES — CLEAR LENS

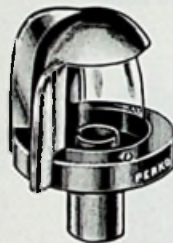

Fig. 1279

### Stern Lights

12 POINTS — 135 DEGREES  
VISIBILITY 3 MILES — CLEAR LENS

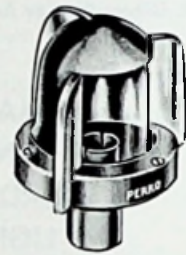

Fig. 1280

Fig.	Per Pair	Each	Height Lens Inches	Length Overall Inches	Width Overall Inches	Height Light Inches	Diam. Flange Inches	Diameter Neck Inches	Length Neck Inches	Weight Pounds	Weight Per Pair Pounds
1278	\$18.00		2 3/8	4 3/8	2 5/8			3/8	1 3/8		2 1/4
1279		\$8.50	2 3/8			2 1/2	2 5/8	3/8	1 3/8	1	
1280		8.50	2 3/8			2 1/2	2 5/8	3/8	1 3/8	1	

### Anchor or Range Lights

32 POINTS — 360 DEGREES  
VISIBILITY 3 MILES — CLEAR OR AMBER LENS

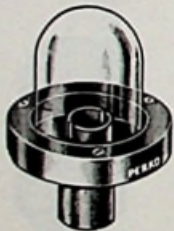

Fig. 1281

Each	Height Lens Inches	Height Light Inches	Diam. Flange Inches
\$7.75	2 1/8	2 3/8	2 3/8
Diameter Neck Inches	Length Neck Inches	Weight Pounds	
3/8	1 3/8	3/8	

### ADJUSTABLE LIGHTS

BOW LIGHT

STERN LIGHT

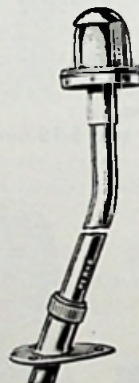

Fig. 1282

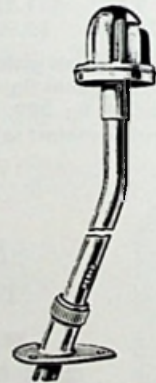

Fig. 1283

When boats of classes A or 1 operate in international waters, the rules require a 225 degree 20 point clear bow light mounted 36 inches higher than the combination red and green light forward. Also a 135 degree 12 point clear stern light aft. Height is 36 inches but can be supplied in special heights to order.

Zamak Chromium Plated Each	Bronze Chromium Plated Each	Height Lens Inches	Dimensions Base Inches	Bronze Weight Pounds
\$13.50	\$20.00	2 1/8	3 3/8 x 2 1/4	2 3/4

### NEW MOUNTING BASE

FOR INTERNATIONAL LIGHTS  
BRASS—BURNISHED OR CHROMIUM PLATED

Has 1/2 inch male pipe thread for use with lights on this and page 21.



Fig. 938

Height to bottom of thread 3/4 inches.  
Weight 5 ounces.

Burnished Each	Chromium Plated Each	Diam. Overall Inches
\$1.75	\$2.25	2 3/8

Spare Parts See Page 21

NOTE—The above globes are large enough to accommodate a 21 C.P. bulb. Laboratory field tests met the required distance of visibility with 6 C.P. bulbs.



**Perko "International" NAVIGATION LIGHTS**

**CAST BRONZE—BURNISHED OR CHROMIUM PLATED—WATERTIGHT**  
 Shielded to U.S.C.G. Visibility Requirements, Revised Rules of Motorboat Act.  
 Effective June 4, 1956—Public Law 552

Legal For All Types of Boats—Under 65 Feet in Length and Under 40 Gross Tons.  
 For Use on Inland and International Waters.

**ELECTRIC—DOUBLE CONTACT BAYONET TYPE SOCKETS**  
 Neck Has 1/2" Female Pipe Thread for Mounting on Pipe  
 Base Drilled for Wood Screws for Mounting Directly to Deck, Cabin Top and Cabin Sides

**Side Lights**

10 POINTS—112 1/2 DEGREES  
 VISIBILITY—2 MILES  
 COLORED LENSES—1 RED AND 1 GREEN

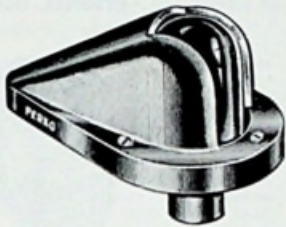

Fig. 910-A

Burnished Bronze Per Pair				Chromium Plated Per Pair	
\$17.00				\$23.00	
Height Lens Inches	Length Overall Inches	Width Overall Inches	Diameter Neck Inches	Length Neck Inches	Weight Per Pair Pounds
2 1/8	5	2 1/8	3/8	1 3/8	3 1/4

For mounting on side of deck house.

**Side Lights**

10 POINTS—112 1/2 DEGREES  
 VISIBILITY—2 MILES  
 COLORED LENSES—1 RED AND 1 GREEN

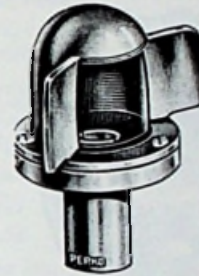

Fig. 910-B

Burnished Bronze Per Pair			Chromium Plated Per Pair		
\$17.00			\$25.50		
Height Lens Inches	Height Light Inches	Diameter Neck Inches	Diameter Flange Inches	Length Neck Inches	Weight Per Pair Pounds
2 1/8	2 1/2	3/8	2 3/8	1 3/8	2 1/2

For mounting on top of deck house.

**Bow or Masthead Lights**

20 POINTS—225 DEGREES  
 VISIBILITY 3 MILES—CLEAR LENS

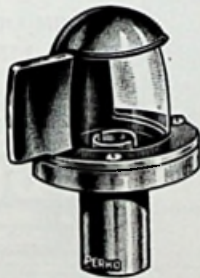

Fig. 911-A

Fig.	Burnished Bronze Each	Chromium Plated Each	Height Lens Inches	Height Light Inches	Diameter Neck Inches	Diameter Flange Inches	Length Neck Inches	Weight Each Pounds
911-A	\$8.25	\$12.50	2 1/8	2 1/2	3/8	2 3/8	1 3/8	1 1/8
912-A	8.25	12.50	2 1/8	2 1/2	3/8	2 3/8	1 3/8	1 1/8
913-A	7.00	8.50	2 1/8	2 3/8	3/8	2 3/8	1 3/8	3/8

**Stern Lights**

12 POINTS—135 DEGREES  
 VISIBILITY 3 MILES—CLEAR LENS

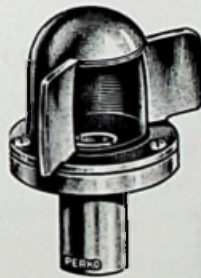

Fig. 912-A

**Anchor or Range Lights**

32 POINTS—360 DEGREES  
 VISIBILITY 3 MILES—CLEAR OR AMBER LENS

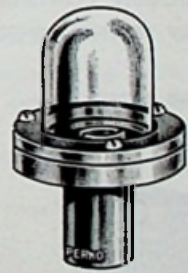

Fig. 913-A

Spare Globes—Clear, Red, Green or Amber . . . . . \$ .95 each

Spare D.C. Sockets, Fig. 747 No. 2, \$.60 each

See Fig. 938 Page 20 New Mounting Base for Above Lights.

**NOTE—The above globes are large enough to accommodate a 21 C.P. bulb. Laboratory field tests met the required distance of visibility with 6 C.P. bulbs.**



## Perko "International" NAVIGATION LIGHTS

SHIELDED TO U.S.C.G. VISIBILITY REQUIREMENTS, REVISED RULES OF MOTOR BOAT ACT  
EFFECTIVE JUNE 4, 1956—PUBLIC LAW 552  
LEGAL FOR ALL TYPES OF BOATS—UNDER 65 FEET IN LENGTH AND UNDER 40 GROSS TON  
FOR USE ON INLAND AND INTERNATIONAL WATERS

### NEW STREAMLINE WATERTIGHT TYPE

Patent No. 2,908,807

ZAMAK DIE CASTINGS—CHROMIUM PLATED  
WATERTIGHT FRESNEL GLOBE WITH PACKING GLAND AT SOCKET AND CABLE ENTRANCE  
ELECTRIC—DOUBLE CONTACT BAYONET TYPE SOCKET

#### SIDE LIGHTS

10 Points—112½ Degrees  
Minimum Visibility—2 Miles  
Colored Lenses  
1 Red and 1 Green

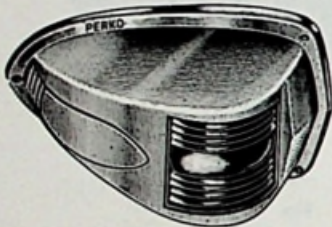

Fig. 1285

Chromium Plated Per Pair	Length Overall Inches	Height Overall Inches	Weight Per Pair Pounds
\$20.00	7¼	3	3

#### BOW LIGHT

20 Points—225 Degrees  
Minimum Visibility—3 Miles  
Clear Lens

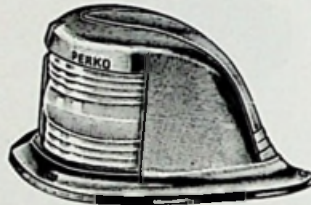

Fig. 1286

Chromium Plated Each	Length Overall Inches	Width Overall Inches	Height Overall Inches	Weight Pounds
\$10.00	6¼	3¾	3½	1¼

#### WATERTIGHT FRESNEL GLOBE

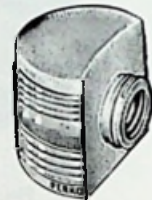

Fig. 258

Clear Each	Red or Green Each	Height Inches	Width Inches	Weight Ounces
\$2.50	\$3.00	2¾	2¾	6

Spare D.C. Socket See Fig. 747 No. 2

### INTERNATIONAL LIGHTS

ELECTRIC ONLY

DOUBLE CONTACT ELECTRIC SOCKET  
CLEAR FRESNEL LENSES—VISIBILITY 3 MILES

#### BOW LIGHT

20 Points—225 Degrees



Fig. 99

#### STERN LIGHT

12 Points—135 Degrees

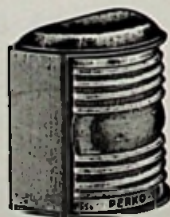

Fig. 98

Fig.	Galv. Each	Polished Brass Each	Chromium Plated Each	Height Lens Inches	Height Overall Inches	Weight Pounds
98	\$9.50	\$11.00	\$13.75	4¼	5¼	1½
99	8.50	10.00	12.75	4¼	5¼	1½

With medium screw socket—add \$.75 each.

### INTERNATIONAL LIGHTS

WROUGHT BRASS—OIL ONLY

CLEAR FRESNEL LENSES—VISIBILITY 3 MILES

#### BOW LIGHT

20 Points—225 Degrees



Fig. 176

#### STERN LIGHT

12 Points—135 Degrees



Fig. 97

Fig.	Polished Brass Each	Chromium Plated Each	Height Lens Inches	Height Overall Inches	Weight Pounds
176	\$12.50	\$15.50	4¼	10½	3½
97	11.50	14.50	4¼	10½	3

Oil and double contact electric—add \$1.75 each.  
Oil and medium screw electric—add \$2.75 each.





## Streamline SIDE LIGHTS

CAST BRONZE  
CLASSES 2 AND 3—ELECTRIC

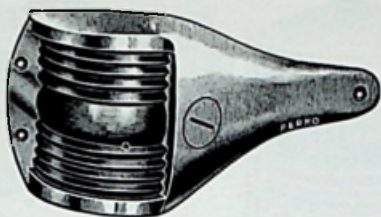

Fig. 563

With our popular rebulbing feature which makes it unnecessary to remove light from the boat to change bulb.

Furnished in pairs, with red and green fresnel lenses and double contact electric sockets.

Class	Height Inches	Length Inches	Height Lens Inches	Weight Per Pair Pounds
2	4 $\frac{3}{4}$	10 $\frac{1}{8}$	4 $\frac{1}{4}$	5 $\frac{1}{2}$
3	6	10 $\frac{1}{2}$	5 $\frac{3}{8}$	7 $\frac{1}{2}$

Class	Polished Bronze Per Pair	Chromium Plated Per Pair	Spare Lenses Each	Spare Sockets Each
2	\$28.00	\$33.50	\$3.45	\$ .60
3	34.00	39.50	4.35	.60

Spare Lenses, see Fig. 259

Spare D.C. Sockets, see Fig. 747, No. 1.

## Streamline BOW LIGHTS

CAST BRONZE  
CLASSES 2 AND 3—ELECTRIC

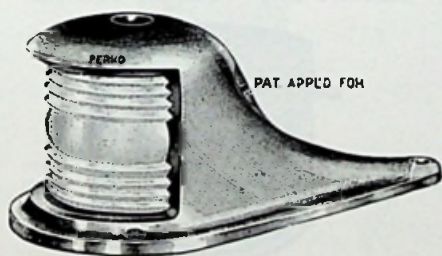

Fig. 561

Furnished with clear fresnel lens and double contact electric socket.

Class	Height Inches	Size Base Inches	Height Lens Inches	Flagpole Socket Inches	Weight Pounds
2	5 $\frac{1}{4}$	5 $\frac{3}{4}$ x 11 $\frac{1}{2}$	4 $\frac{1}{4}$	1	7
3	6 $\frac{3}{8}$	6 $\frac{3}{8}$ x 13	5 $\frac{3}{8}$	1	8 $\frac{3}{4}$

Class	Polished Bronze Each	Chromium Plated Each	Spare Lenses Each	Spare Sockets Each
2	\$24.75	\$30.50	\$3.45	\$ .90
3	29.00	35.00	4.35	.90

Spare Lenses, see Fig. 260.

Spare D.C. Sockets, see Fig. 747, No. 7.

## Streamline SIDE LIGHTS

WROUGHT BRASS  
CLASS 2—ELECTRIC

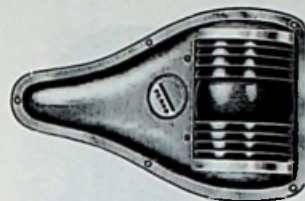

Fig. 1138

Design is gracefully streamlined and quality is up to our usual high standard.

Contains our patented swivel type waterproof rebulbing feature, no screws to remove.

Furnished in pairs, with red and green fresnel lenses and double contact electric sockets.

Extreme Height Inches	Extreme Length Inches	Height Lens Inches	Weight Per Pair Pounds
6 $\frac{5}{8}$	9 $\frac{5}{8}$	4 $\frac{1}{4}$	3 $\frac{1}{4}$

Bright Finish Per Pair	Polished Brass Per Pair	Chromium Plated Per Pair	Spare Lenses Each	Spare Sockets Each
\$22.75	\$25.50	\$31.00	\$3.45	\$ .60

Spare Lenses, see Fig. 259

Spare D.C. Sockets, see Fig. 747, No. 1.

## Streamline BOW LIGHTS

WROUGHT BRASS  
CLASS 2—ELECTRIC

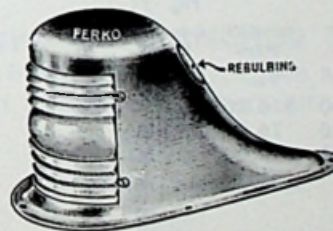

Fig. 1139

A very attractive running mate for Fig. 1138 above.

Containing our swivel type waterproof rebulbing feature, no screws to remove.

Furnished with clear fresnel lens and double contact electric socket.

A flag pole socket in top if required.

Height Inches	Size Base Inches	Height Lens Inches	Flagpole Socket Inches	Weight Pounds
5 $\frac{1}{2}$	5 $\frac{3}{8}$ x 9 $\frac{1}{2}$	4 $\frac{1}{4}$	1	2

Bright Finish Each	Polished Brass Each	Chromium Plated Each	Spare Lenses Each	Spare Sockets Each
\$16.25	\$17.75	\$20.00	\$3.45	\$ .90

Spare Lenses, see Fig. 260.

Spare D.C. Sockets, see Fig. 747, No. 7.

With Flag Pole Socket add \$1.25 each.

Furnished without Flag Pole Socket unless otherwise specified.

SPARE REBULBING FEATURES FOR ALL ABOVE LIGHTS, POLISHED \$2.50, CHROMIUM PLATED \$3.00 EACH  
LIGHTS ON THIS PAGE CANNOT BE SUPPLIED WITH MEDIUM SCREW SOCKET.



## Royal COMBINATION BOW LIGHTS

ELECTRIC ONLY—DOUBLE CONTACT  
WITH RED AND GREEN LENSES

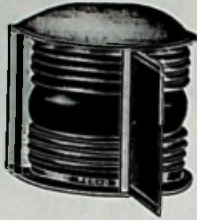

Fig. 89

Galv. Each	Polished Brass Each	Chromium Plated Each	Height Inches	Width Inches	Height Lens Inches	Weight Pounds
\$8.50	\$10.25	\$12.25	3 $\frac{3}{8}$	4 $\frac{1}{4}$	3 $\frac{3}{8}$	1 $\frac{1}{2}$

Spare Lenses, see Fig. 259, Cl. 1.

## Royal SIDE LIGHTS

ELECTRIC ONLY—DOUBLE CONTACT  
WITH RED AND GREEN LENSES



Fig. 91

Class	Galv. Per Pair	Polished Brass Per Pair	Chromium Plated Per Pair	Height Inches	Height Lens Inches	Weight Per Pair Pounds
1	\$12.50	\$16.30	\$20.50	4 $\frac{1}{4}$	3 $\frac{3}{8}$	1 $\frac{3}{4}$
2	13.20	16.75	21.00	5	4 $\frac{1}{4}$	2
3	15.25	19.00	23.00	6	5 $\frac{3}{8}$	3

Spare Lenses, see Fig. 259.

## Royal BOW LIGHTS

ELECTRIC ONLY—DOUBLE CONTACT  
WITH CLEAR LENS



Fig. 92

Class	Galv. Each	Polished Brass Each	Chromium Plated Each	Height Inches	Height Lens Inches	Weight Pounds
1	\$6.25	\$8.15	\$10.25	4 $\frac{1}{4}$	3 $\frac{3}{8}$	1
2	6.60	8.40	10.50	5	4 $\frac{1}{4}$	1 $\frac{1}{2}$
3	7.60	9.50	11.50	6	5 $\frac{3}{8}$	2

Spare Lenses, see Fig. 260.

All above lights with medium screw adapter, Fig. 153, add \$1.00 Each.

## De-Lite SIDE LIGHTS

CAST BRONZE—WITH FRONT DOORS  
RED AND GREEN LENSES  
ELECTRIC ONLY—DOUBLE CONTACT

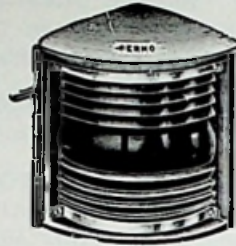

Closed

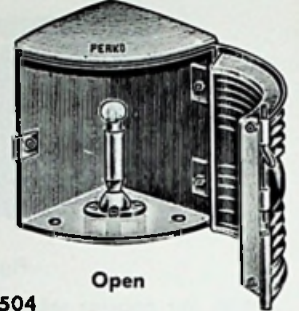

Open

Fig. 504

A quick change of bulb or lens is simple. Lenses are fastened in doors by brass straps and machine screws. Doors have positive latch which cannot work loose due to vibration or wind.

Class	Height Inches	Angle Inches	Height Lens Inches	Weight Per Pair Pounds
2	5 $\frac{1}{2}$	3 $\frac{3}{4}$ x 3 $\frac{3}{4}$	4 $\frac{1}{4}$	6 $\frac{1}{2}$
3	6	4 x 4	5 $\frac{3}{8}$	8

Class	Polished Bronze Per Pair	Chromium Plated Per Pair	Spare Lenses Each	Spare Sockets Each
2	\$29.00	\$34.00	\$3.45	\$ .95
3	31.00	36.00	4.35	.95

With medium screw sockets, add \$3.50 per pair.

Spare D.C. Sockets, see Fig. 276, No. 0.

Spare Lenses, see Fig. 259.

With clear lens, Class 2 only, add \$2.00 per pair.

## De-Lite BOW LIGHTS

CAST BRONZE—WITH FRONT DOORS  
CLEAR LENS  
ELECTRIC ONLY—DOUBLE CONTACT



Fig. 505

Same construction as Fig. 504 above.

Class	Height Inches	Width Inches	Height Lens Inches	Weight Pounds
2	5 $\frac{1}{2}$	5 $\frac{1}{2}$	4 $\frac{1}{4}$	3 $\frac{3}{4}$
3	6 $\frac{1}{2}$	6	5 $\frac{3}{8}$	4 $\frac{1}{4}$

Class	Polished Bronze Each	Chromium Plated Each	Spare Lenses Each	Spare Sockets Each
2	\$14.50	\$17.00	\$3.45	\$ .95
3	15.50	18.00	4.35	.95

With Medium screw sockets, add \$1.75 Each.

Spare D.C. Sockets, see Fig. 276, No. 0.

Spare Lenses, see Fig. 260.

With Colored Lens, Class 2, add \$1.75 Each.

With Colored Lens, Class 3, add \$2.50 Each.

Colored Lenses are Red, Green or Blue.

Amber available in Class 2 only.



## "Perko" De-Lite ANCHOR LIGHTS

TURRET TOP—REMOVABLE GUARDS  
FOR CLASSES 1, 2, AND 3 BOATS

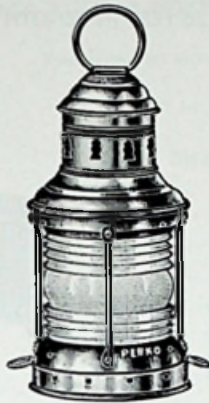

Fig. 0-2 Junior  
Fig. 0-6 Senior

Fig.	Height Less Ring Inches	Diam. Base Inches	Height Lens Inches	Weight Pounds
0-2	8 $\frac{3}{8}$	4 $\frac{1}{2}$	3 $\frac{3}{8}$	2
0-6	11 $\frac{3}{4}$	5 $\frac{3}{8}$	4 $\frac{1}{4}$	3

### OIL OR ELECTRIC ONLY

Fig.	Galv. Each	Polished Brass Each	Chromium Plated Each
0-2	\$10.00	\$12.50	\$15.50
0-6	12.00	14.50	17.50

Comb. Oil and Electric, add \$1.75 each.

### FLAT TOP—REMOVABLE GUARDS

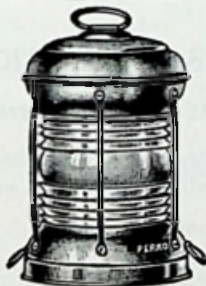

Fig. 11 Junior  
Fig. 12 Senior

Fig.	Height Less Ring Inches	Diam. Base Inches	Height Lens Inches	Weight Pounds
11	6	4 $\frac{1}{2}$	3 $\frac{3}{8}$	1 $\frac{1}{2}$
12	9	5 $\frac{3}{8}$	4 $\frac{1}{4}$	2 $\frac{1}{2}$

### ELECTRIC ONLY—DOUBLE CONTACT SOCKETS

Fig.	Galv. Each	Polished Brass Each	Chromium Plated Each
11	\$10.00	\$12.50	\$15.50
12	12.00	14.50	17.50

With Red, Green, Blue or Amber Lens.

Figs. 0-2 and 11, add \$2.25 each.

Figs. 0-6 and 12, add \$2.60 each.

All above lights with Medium Screw Electric Sockets, add \$1.00 each.

### SPARE PARTS

	Each
Lenses, fig. 261, Clear, for figs. 0-2 and 11	\$2.50
Lenses, fig. 261, Clear, for figs. 0-6 and 12	3.35
Oil Founts, fig. 287, Brass, for fig. 0-2	2.30
Oil Founts, fig. 286, Brass, for fig. 0-6	2.30
Oil and Electric Founts, fig. 735, for fig. 0-2	5.00
Oil and Electric Founts, fig. 736, for fig. 0-6	5.00
Oil Burners, fig. 246, No. 0, Brass, for fig. 0-2	.42
Oil Burners, fig. 246, No. 1, Brass, for fig. 0-6	.47

## 10 Day Oil ANCHOR LIGHT

360 DEGREE CLEAR FRESNEL LENS  
LATCHED SWIVEL FOUNT



Fig. 596



Fig. 596A

At least 10 days of continuous light on one filling of good grade kerosene. Wick is non-carbonizing type.

Polished Brass Each	Height Lens Inches	Height Overall Inches	Diam. Fount Inches	Capacity Fount Pints	Weight Pounds
\$28.50	4 $\frac{1}{4}$	14	7	3 $\frac{1}{2}$	4 $\frac{1}{2}$

With red, green, blue or amber lens, add \$2.60 each.

Fig. 596-A Fount complete, \$14.25 each.

Light only, less Fount, \$17.00 each.

Spare burners, wicks and chimneys, see figs. 245 and 272.

Spare lenses, see fig. 261.

## 21 Day Battery ANCHOR LIGHT

ALL BRASS—WITH SWITCH AND BULB  
SWITCH ENCLOSED IN WATERTIGHT COVER



Fig. 48

500 hours of continuous light on one battery.

Uses ordinary 1 $\frac{1}{2}$  volt dry cell such as Eveready No. 6 or equal. Bulb is Mazda No. 1800.

Polished Brass Each	Chromium Plated Each	Height Inches	Diam. Base Inches
\$16.50	\$19.25	10 $\frac{1}{2}$	3

With battery, add \$2.00 each.

With red, green or blue globe, add \$.60 each.

Spare globes, see Fig. 250.

Spare batteries, \$1.50 each.

Spare bulbs, \$.40 each.



## "Perko" De-Lite Combination BOW LIGHTS

TURRET TOP—FRONT DOOR

FOR CLASS ONE BOATS—16 FEET AND OVER AND LESS THAN 26 FEET IN LENGTH

OIL AND ELECTRIC, DOUBLE CONTACT

Green Lens for Starboard, Red Lens for Port  
 Height, less ring, 9 $\frac{3}{8}$  inches  
 Measurements of base, 5 inches x 5 $\frac{1}{2}$  inches  
 Height of lens, 3 $\frac{3}{8}$  inches  
 Weight, 3 $\frac{3}{8}$  pounds

Fig. 0-1

Galvanized Each	Polished Brass Each	Chromium Plated Each
\$14.25	\$16.75	\$21.00



(Closed)

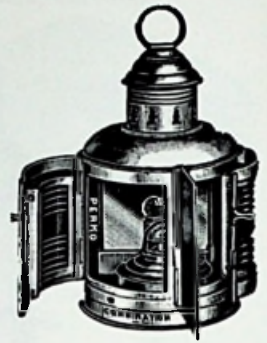

(Opened)

## De-Lite Combination BOW LIGHTS

FLAT TOP—FRONT DOOR

ELECTRIC ONLY—DOUBLE CONTACT SOCKET

Height, less ring, 6 $\frac{1}{2}$  inches  
 Measurements of base, 5 inches x 5 $\frac{1}{2}$  inches  
 Height of lens, 3 $\frac{3}{8}$  inches  
 Weight, 3 pounds

Fig. 0-10

Galvanized Each	Polished Brass Each	Chromium Plated Each
\$14.25	\$16.75	\$21.00



(Closed)

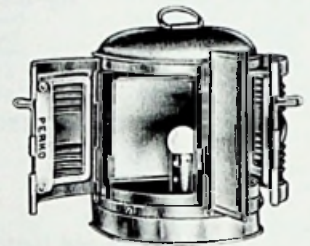

(Opened)

## Combination BOW LIGHTS

TURRET TOP OR FLAT TOP

BOTTOM OPENING

WITH RED AND GREEN LENSES

TURRET TOP

Height less Ring, 9 inches.  
 Meas. of Base, 4 $\frac{3}{4}$ x4 $\frac{1}{2}$  inches.  
 Height of Lenses, 3 $\frac{3}{8}$  inches.  
 Weight, 2 $\frac{3}{8}$  pounds.

	Galvanized Each	Polished Brass Each
Oil or Elec. Only	\$11.00	\$13.75
Oil and Electric	12.00	14.75



Fig. 1

FLAT TOP

Height less Ring, 6 $\frac{1}{4}$  inches.  
 Meas. of Base, 4 $\frac{3}{4}$ x4 $\frac{1}{2}$  inches.  
 Height of Lenses, 3 $\frac{3}{8}$  inches.  
 Weight, 2 pounds.

	Galvanized Each	Polished Brass Each
Electric Only	\$11.00	\$13.75
Chromium plated finish, add \$3.75 each to Polished Brass price.		



Fig. 3

Electric Socket is Double Contact.

## Sail Boat SIDE LIGHTS

SMALL SIZE—OIL BURNING

Designed for Sail Boats where small oil burning side lights are desirable.

Height Lens Inches	Extreme Height Inches	Diam. of Base Inches	Weight Per Pair Pounds
3 $\frac{3}{8}$	9	4 $\frac{1}{4}$	4

Galvanized Per Pair	Polished Brass Per Pair	Chromium Plated Per Pair
\$17.50	\$22.00	\$29.50



Fig. 69

Oil and Electric, with Fig. 735, Fount, add \$3.50 per pair.

Electric socket is bayonet double contact.

Spare Lenses, see Figs. 259, Class 1.

Spare Founts, see Figs. 287 or 735.

Spare Burners and Wicks, see Figs. 246 and 302 No. 0.

ALL LIGHTS ON THIS PAGE WITH MEDIUM SCREW ELECTRIC SOCKETS ADD \$1.00 EACH

### SPARE PARTS

	EACH	EACH
Lenses, Fig 259, Class 1 Combination	\$2.50	Oil Burners, Fig. 246, No. 0, Brass
Oil Founts, Fig. 582, Brass, for Fig. 01.	2.30	Oil Wicks, Fig. 302, No. 0
Oil Founts, Fig. 733, Brass, for Fig. 1	2.30	Electric Sockets, Double Contact, Fig. 276, No. 2
Oil and Electric Founts, Fig. 733, Brass, for Fig. 1	5.00	Electric Sockets, Medium Screw, Fig. 346, No. 1



## "Perko" De-Lite SIDE LIGHTS

TURRET TOP

FOR CLASS 2 BOATS—26 FEET OR OVER AND LESS THAN 40 FEET IN LENGTH  
OIL AND ELECTRIC, DOUBLE CONTACT

Furnished in pairs—one green light for Starboard and one red light for Port

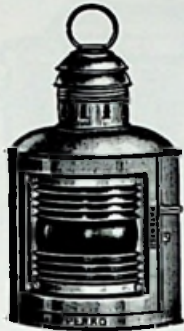

(Closed)

Height, less ring, 10½ inches  
Measurements of base, 5¼ inches x 5¼ inches  
Height of lens, 4¼ inches  
Weight, per pair, 6¼ pounds

Fig. 0-4

Galvanized Per Pair	Polished Brass Per Pair	Chromium Plated Per Pair
\$24.50	\$30.00	\$38.50

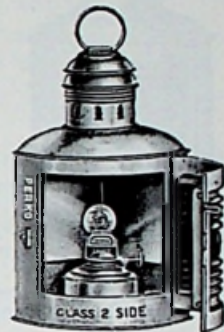

(Opened)

## "Perko" De-Lite BOW LIGHTS

TURRET TOP

CLASS 2—OIL AND ELECTRIC, DOUBLE CONTACT

Height, less ring, 10½ inches  
Height of lens, 4¼ inches  
Measurements of base, 5 inches x 5½ inches  
Weight, each 3 pounds

Fig. 0-5

	Galvanized Each	Polished Brass Each	Chromium Plated Each
With Clear Lens	\$12.25	\$15.00	\$19.25
With Red, Green, Amber or Blue Lens	14.75	17.50	21.75

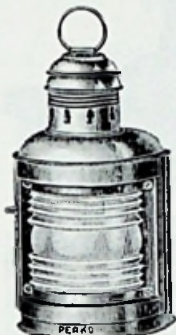

(Closed)

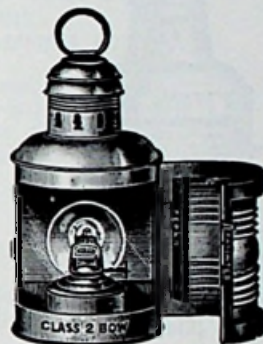

(Opened)

## "Perko" De-Lite SIDE LIGHTS

FLAT TOP—CLASS 2

ELECTRIC ONLY—DOUBLE CONTACT SOCKET

Height, less ring, 7¼ inches  
Measurements of base, 5⅞ inches x 5⅞ inches  
Height of lens, 4¼ inches  
Weight, per pair, 5½ pounds

Fig. 0-40

Galvanized Per Pair	Polished Brass Per Pair	Chromium Plated Per Pair
\$24.50	\$30.00	\$38.50

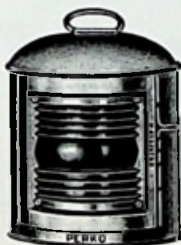

(Closed)



(Opened)

## "Perko" De-Lite BOW LIGHTS

FLAT TOP—CLASS 2

ELECTRIC ONLY—DOUBLE CONTACT SOCKET

Height, less ring, 7⅞ inches  
Measurements of base, 5 inches x 5½ inches  
Height of lens, 4¼ inches  
Weight, each, 2¾ pounds

Fig. 0-50

	Galvanized Each	Polished Brass Each	Chromium Plated Each
With Clear Lens	\$12.25	\$15.00	\$19.25
With Red, Green, Amber or Blue Lens	14.75	17.50	21.75



(Closed)



(Opened)

ALL LIGHTS ON THIS PAGE WITH MEDIUM SCREW ELECTRIC SOCKETS ADD \$1.00 EACH

### SPARE PARTS

	Each
Lenses, fig. 259, Class 2, for figs. 0-4 and 0-40	\$3.45
Lenses, fig. 260, Class 2, for figs. 0-5 and 0-50	3.45
Oil Founts, fig. 582, Brass, for figs. 0-4 and 0-5	2.30
Oil Burners, fig. 246, No. 1, Brass for figs. 0-4 and 0-5	.47
Oil Wicks, fig. 302, No. 1	.08
Electric Sockets, Double Contact, fig. 276, No. 2	.95
Electric Sockets, Medium Screw, fig. 346, No. 1	.70



(Closed)

**"Perko" De-Lite SIDE LIGHTS**  
**TURRET TOP**  
 FOR CLASS 3 BOATS—40 FEET OR OVER AND  
 NOT MORE THAN 65 FEET IN LENGTH  
 OIL AND ELECTRIC, DOUBLE CONTACT

Height of lens, 5 $\frac{3}{8}$  inches  
 Height, less ring, 12 $\frac{1}{4}$  inches  
 Measurements of base, 5 $\frac{3}{8}$  inches x 5 $\frac{3}{8}$  inches  
 Weight, per pair, 8 pounds

Galvanized Per Pair	Polished Brass Per Pair	Chromium Plated Per Pair
\$28.50	\$34.50	\$44.00

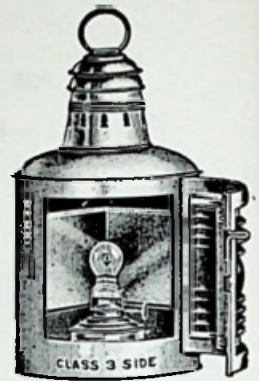

(Opened)



(Closed)

**"Perko" De-Lite BOW LIGHTS**  
**TURRET TOP**  
 CLASS 3—OIL AND ELECTRIC, DOUBLE CONTACT

Height of lens, 5 $\frac{3}{8}$  inches  
 Height, less ring, 12 $\frac{1}{4}$  inches  
 Measurements of base, 5 $\frac{1}{2}$  inches x 6 $\frac{1}{8}$  inches  
 Weight, each, 4 pounds

Fig. 0-9

	Galvanized Each	Polished Brass Each	Chromium Plated Each
With clear lens	\$14.25	\$17.25	\$22.00
With Red, Green or Blue Lens	17.25	20.25	25.00

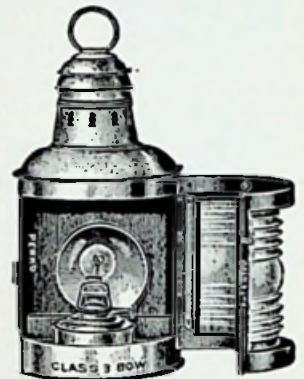

(Opened)

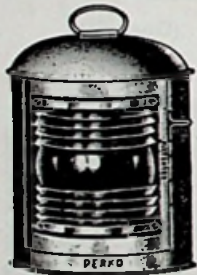

(Closed)

**"Perko" De-Lite SIDE LIGHTS**  
**FLAT TOP—CLASS 3**  
**ELECTRIC ONLY—DOUBLE CONTACT SOCKET**  
 Height of lens, 5 $\frac{3}{8}$  inches  
 Height, less ring, 8 $\frac{1}{2}$  inches  
 Measurements of base, 5 $\frac{3}{8}$  inches x 5 $\frac{3}{8}$  inches  
 Weight, per pair, 7 pounds

Fig. 0-80

Galvanized Per Pair	Polished Brass Per Pair	Chromium Plated Per Pair
\$28.50	\$34.50	\$44.00



(Opened)



(Closed)

**"Perko" De-Lite BOW LIGHTS**  
**FLAT TOP—CLASS 3**  
**ELECTRIC ONLY—DOUBLE CONTACT SOCKET**  
 Height of lens, 5 $\frac{3}{8}$  inches  
 Height, less ring, 8 $\frac{1}{2}$  inches  
 Measurements of base, 5 $\frac{3}{8}$  inches x 6 $\frac{1}{8}$  inches  
 Weight, each, 4 pounds

Fig. 0-90

	Galvanized Each	Polished Brass Each	Chromium Plated Each
With clear lens	\$14.25	\$17.25	\$22.00
With Red, Green or Blue Lens	17.25	20.25	25.00

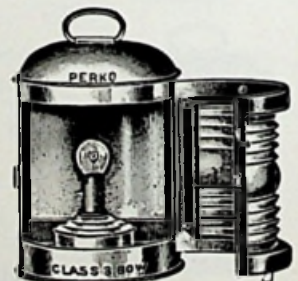

(Opened)

**ALL LIGHTS ON THIS PAGE WITH MEDIUM SCREW ELECTRIC SOCKETS ADD \$1.00 EACH**  
**SPARE PARTS**

Lenses, fig. 259, Class 3, for figs. 0-8 and 0-80	Each	\$4.35
Lenses, fig. 260, Class 3, for figs. 0-9 and 0-90	Each	4.35
Oil Founts, fig. 582, Brass, for figs. 0-8 and 0-9	Each	2.30
Oil Burners, fig. 246, No. 1, Brass, for figs. 0-8 and 0-9	Each	.47
Oil Wicks, fig. 302, No. 1	Each	.08
Electric Sockets, Double Contact, fig. 276, No. 3	Each	.95
Electric Sockets, Medium Screw, fig. 346, No. 1	Each	.70



## Class 2 SIDE LIGHTS RED AND GREEN LENSES BOTTOM OPENING—SPRING FOUNT



Fig. 17

Height of Lenses,  $4\frac{1}{4}$  inches.  
Extreme Height,  $10\frac{1}{2}$  inches.  
Size of Base,  $4\frac{1}{4} \times 5\frac{1}{2}$  inches.  
Weight, per pair,  $5\frac{1}{2}$  lbs.

	Galvanized Per Pair	Polished Brass Per Pair
Oil or Elec. only	\$19.50	\$23.00
Oil and Electric	23.00	26.50

Chromium plated finish, add \$7.00 per pair to Polished Brass price.

## Class 2 BOW LIGHTS CLEAR LENS BOTTOM OPENING—SPRING FOUNT



Fig. 18

Height of Lens,  $4\frac{1}{4}$  inches.  
Extreme Height,  $10\frac{1}{2}$  inches.  
Size of Base,  $4\frac{1}{2} \times 5$  inches.  
Weight, each, 3 lbs.

	Galvanized Each	Polished Brass Each
Oil or Elec. only	\$ 9.75	\$11.50
Oil and Electric	11.50	13.25

Chromium plated finish, add \$3.50 each to Polished Brass price.

With red, green, amber or blue lens, add \$2.50 each.

## Class 3 SIDE LIGHTS RED AND GREEN LENSES BOTTOM OPENING—SPRING FOUNT

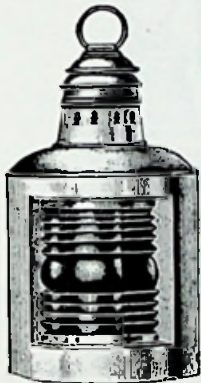

Fig. 19

Height of Lenses,  $5\frac{5}{8}$  inches.  
Extreme Height,  $12\frac{1}{2}$  inches.  
Size of Base  $5 \times 6\frac{1}{4}$  inches.  
Weight, per pair,  $7\frac{1}{2}$  lbs.

	Galvanized Per Pair	Polished Brass Per Pair
Oil or Elec. only	\$23.00	\$29.00
Oil and Electric	27.00	33.00

Chromium plated finish, add \$8.00 per pair to Polished Brass price.

## Class 3 BOW LIGHTS CLEAR LENS BOTTOM OPENING—SPRING FOUNT



Height of Lens,  $5\frac{5}{8}$  inches.  
Extreme Height,  $12\frac{1}{2}$  inches.  
Size of Base,  $5\frac{1}{2} \times 6\frac{1}{4}$  inches.  
Weight, each,  $3\frac{1}{2}$  lbs.

	Galvanized Each	Polished Brass Each
Oil or Elec. only	\$11.50	\$14.50
Oil and Electric	13.50	16.50

Chromium plated finish, add \$4.00 each to Polished Brass price.

With Red, Green, Blue or Amber Lens add \$3.00 each.

Fig. 20

## Flat Top SIDE LIGHTS CLASSES 2 AND 3—RED AND GREEN LENSES BOTTOM OPENING—SPRING FOUNT ELECTRIC ONLY—DOUBLE CONTACT SOCKET



Fig. 4

### CLASS 2

Height of Lenses,  $4\frac{1}{4}$  inches.  
Extreme Height,  $7\frac{1}{4}$  inches.  
Size of Base  $4\frac{3}{4} \times 5\frac{1}{2}$  inches.  
Weight, per pair, 5 lbs.

### CLASS 3

Height of Lenses,  $5\frac{5}{8}$  inches.  
Extreme Height,  $8\frac{1}{2}$  inches.  
Size of Base,  $5 \times 6\frac{1}{4}$  inches.  
Weight, per pair, 7 lbs.

Class	Galvanized Per Pair	Polished Brass Each	Chromium Plated Per Pair
2	\$19.50	\$23.00	\$30.00
3	23.00	29.00	37.00

## Flat Top BOW LIGHTS CLASSES 2 AND 3—CLEAR LENS BOTTOM OPENING—SPRING FOUNT ELECTRIC ONLY—DOUBLE CONTACT SOCKET



### CLASS 2

Height of Lens,  $4\frac{1}{4}$  inches.  
Extreme Height,  $7\frac{1}{4}$  inches.  
Size of Base,  $4\frac{1}{2} \times 5$  inches.  
Weight, each,  $2\frac{1}{2}$  lbs.

### CLASS 3

Height of Lens,  $5\frac{5}{8}$  inches.  
Extreme Height,  $8\frac{1}{2}$  inches.  
Size of Base,  $5\frac{1}{2} \times 6\frac{1}{4}$  inches.  
Weight, each,  $3\frac{1}{4}$  lbs.

Fig. 5

Class	Galvanized Each	Polished Brass Per Pair	Chromium Plated Each
2	\$ 9.75	\$11.50	\$15.00
3	11.50	14.50	18.50

Class 2 with Red, Green, Blue or Amber Lens add \$2.50 each.

Class 3 with Red, Green, Blue or Amber Lens add \$3.00 each.

ALL LIGHTS ON THIS PAGE WITH MEDIUM SCREW ELECTRIC SOCKETS ADD \$1.00 EACH  
SPARE PARTS

Oil and Electric Founts fig. 736  
Oil Founts, fig. 286  
Lenses, figs. 259 and 260

Electric Adapters, figs. 291 or 292  
Electric D.C. Adapters, fig. 355  
Oil Burners and Wicks, figs. 246 and 302 No. 1

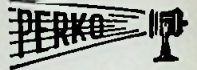

## TOWING or SIGNAL LIGHTS

ALL CAST BRONZE—WITH WATERTIGHT BOX  
MEDIUM SCREW SOCKET—CLEAR FRESNEL GLOBES—CAST BRONZE GUARD  
MAXIMUM LAMP 60 WATTS—VISIBILITY 5 MILES PER U.S.C.G. REGULATIONS

### SINGLE - DOUBLE AND TRIPLE LIGHTS

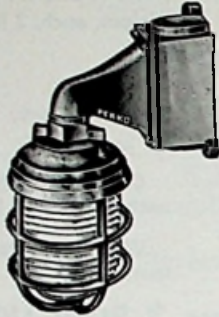

Fig. 540

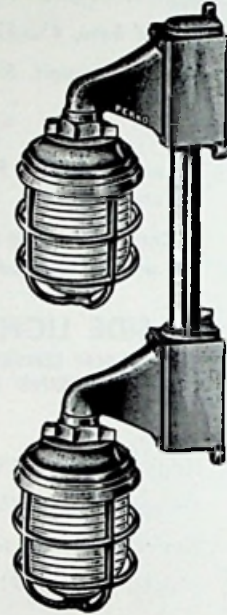

Fig. 541

Fig.	Each	Height Overall Inches	Width Overall Inches	Weight Pounds
540	Single	\$ 32.00	10 $\frac{1}{4}$	6 $\frac{3}{4}$
541	Double	\$ 74.50	46 $\frac{1}{2}$	16
542	Triple (Not Illustrated)	\$118.00	82 $\frac{1}{2}$	25 $\frac{1}{2}$

NOTE: Double and Triple Lights with  $\frac{1}{2}$ " Brass Pipe, Lights 3 feet apart.

TAPPING Fig. 540 with one  $\frac{1}{2}$  inch pipe tap, add \$.50, with two  $\frac{1}{2}$  inch pipe taps, add \$1.00. Box will accommodate  $\frac{3}{4}$  inch pipe tap, if such tapping required, price on application.

Figs. 541 and 542 are tapped for the connecting pipe only. If additional taps required, see above.

Figs. 541 and 542 with  $\frac{3}{4}$  inch pipe or tapping for same, price on application.

SPARE GLOBES clear Fig. 106, \$3.60 each.

COLOR GLOBES can be supplied. Colors are red, green, blue or amber. Add \$1.35 for each globe.

SPARE GUARDS Cast Bronze. \$5.50 each.

SPARE SOCKETS Porcelain Fig. 222 No. 1, \$.90 each.

## Navy or Life Boat LANTERN



Fig. 49

OIL BURNING  
HINGED TOP—CLEAR GLOBE

Galvanized Each	Polished Brass Each	Height Inches
\$11.50	\$14.00	11
Diam. of Base Inches	Size of Globe Inches	Weight Pounds
5 $\frac{3}{8}$	4x6 $\frac{1}{2}$	3

With Red or Green globe, add \$1.50 each.

With electric adapter fig. 292, add \$1.20 each.

### SPARE PARTS

Globe fig. 262.

Burner fig. 246, size 1.

Wick fig. 302, size 1.

Fount fig. 286.

## Bulkhead LANTERN



Fig. 46

OIL BURNING

No.	Size Body Inches	
1	7 x 9 $\frac{1}{2}$ x 13	
2	9 x 13 x 17	
No.	Galv. Each	Polished Brass Each
1	\$30.00	\$40.00
2	32.00	42.00

Supplied for electric only with medium screw socket to order, add \$4.50 each.

Spare brass founts only, \$6.00 each.

Spare reflectors, \$5.50 each.

Spare burners, see Fig. 242 No. 2.

Spare chimneys, see Fig. 267 No. 2.

Spare electric adapters, see Fig. 58.



## BLINKER AND LOADING LIGHT



Fig. 1163

**CAST BRONZE—PLAIN FINISH  
WITH RED AND CLEAR FRESNEL LENSES  
MEDIUM SCREW BAKELITE SOCKETS**

Four sockets in lower section for 25 watt tubular bulbs. One socket in upper section for bulb up to 60 watt. Bulbs not included. Base threaded 1 inch I. P. S.

Extreme Height Inches	Height Red Lens Inches	Height Clear Lens Inches	Weight Pounds
17½	5	5½	18
Each		Tubular Bulbs Each	Spare Sockets Each
\$82.50		\$1.00	\$.75

Spare clear lenses fig. 261, \$9.60 each.  
Spare red lens fig. 106, \$4.95 each.

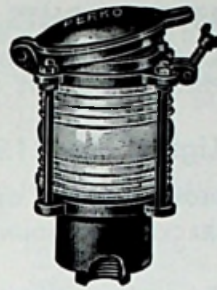

Fig. 403

**Mast  
or  
Blinker  
SIGNALING  
LIGHTS**

With Hinged Top  
For Rebulbing.

**CAST BRONZE—WATERTIGHT—PLAIN FINISH  
WITH 360° FRESNEL LENS**

Size No.	Height Lens Inches	Height Overall Inches	I. P. S. Thread Inches	Weight Pounds	For Vessel Feet
1	3¾	6¾	½	4	up to 65
2	4¼	8¼	¾	6	65 to 150
3	5½	9¾	1	10	over 150

Size No.	Clear Each	Each Colored	Electrical Equipment
1	\$24.00	\$25.00	1 medium screw socket
2	28.00	30.00	1 medium screw socket
2-B	35.00	37.00	6 light candelabra unit
2-C	32.00	34.00	1 mogul 3 wire socket
3	39.00	46.00	1 medium screw socket
3-A	45.00	52.00	4 medium screw sockets
3-C	47.00	54.00	6 light candelabra unit
3-D	43.00	50.00	1 mogul 3 wire socket

All above sockets are Phenolic (Bakelite).

For spare lenses, see fig. 261.

Colored lenses are red, green, blue or amber.

### BULBS FOR ABOVE

120 volt 60 watt A-19 clear for Nos. 1, 2, 3, \$.60 each.

120 volt 25 watt T-10 clear for No. 3-A, \$.80 each.

120 volt, 50/50 watt P-25 clear for No. 2-C, 3-D, \$7.75 each.

120 volt, 15 watt, T-7 clear with candelabra base for Nos. 2-B and 3-C. \$.95 each.

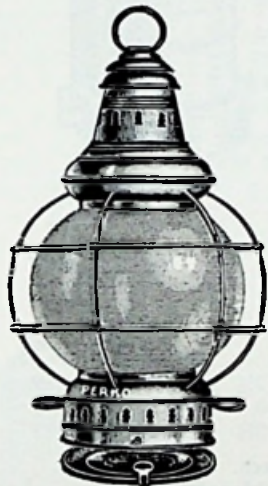

Fig. 44

**Globe  
Distress  
or  
SIGNAL  
LIGHT**

CLEAR GLOBE  
OIL BURNING

No.	Diam. Globe Inches	Galv. Steel Each	Polished Brass Each	Height Overall Inches	Weight Pounds
1	6	\$17.50	\$26.50	11	4
2	8	20.50	31.00	14½	6
3	10	36.75	49.50	22	12

With red, green, blue or frosted globe, add \$5.00 each.

Electric only, same prices as above.

Comb. oil and electric 6 and 8 inch, add \$1.75 each.

Comb. oil and electric 10 inch, add \$4.25 each.

Hinged bottom furnished with 8 inch size only.

### SPARE PARTS

Size	Globes	Burners	Founts	
			Oil	Elec.
6	Fig. 264	Fig. 246 No. 0	Fig. 287	Fig. 274
8	Fig. 264	Fig. 246 No. 1	Fig. 286	Fig. 292
10	Fig. 264	Fig. 242 No. 2	Fig. 282	Fig. 288

Note—6 inch size with Green Globe, not available

## Watertight BLINKER KEY

**CAST BRONZE—PLAIN FINISH  
TUNGSTEN POINTS—CONDENSER  
U.S.C.G. APPROVED**



Fig. 9

Condenser is metal encased, 400 volts D.C. 25 M.F.D. Ground test 2000 volts.

Cover sealed by 6 screws and rubber gasket. Box has three mounting lugs.

Each	Length Inches	Width Inches	Height Inches	Weight Pounds
\$33.50	4¾	2¾	2¾	4

Interior complete with Condenser, each \$13.00.



## ELECTRIC NAVIGATION LIGHTS FOR VESSELS OVER 65 FT. LONG

Watertight — Cast Bronze Rebulbing Cap — Terminal Tubes  
MOGUL 3-WIRE PHENOLIC SOCKETS FIG. 270 FOR DOUBLE FILAMENT BULBS

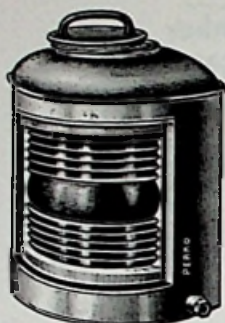

Fig. 1150

### Side Lights, Fig. 1150

112½ DEGREE RED AND GREEN LENSES—10 POINT—IN PAIRS  
WITH BRACKET FOR MOUNTING

No.	Galvanized Steel Per Pair	Polished Brass Per Pair	Lens Fig. 259 Height Inches	Height Less Handle Inches	Size Base Inches	Weight Per Pair Pounds	For Size Vessel Feet
1	\$115.00	\$142.00	6¾	11	7¼x 7¼	18	65 to 150
2	146.00	177.00	7½	13½	9½x 9½	30	over 150
3	243.00	285.00	8½	15¼	10¾x10¾	36	over 150

### Masthead, Range and Towing Lights, Fig. 1151

225 DEGREE CLEAR LENS—20 POINT  
WITH FOUR LUGS FOR MOUNTING

No.	Galvanized Steel Each	Polished Brass Each	Lens Fig. 256 Height Inches	Height Less Handle Inches	Size Base Inches	C to C of Lugs Inches	Weight Each Pounds
1	\$ 57.50	\$ 71.00	6¾	11	7¼x 7¾	8¾	10
2	73.00	88.50	7½	13½	9 x10	10¾	15
3	121.50	142.50	8½	15¼	10¾x11¼	12¾	21



Fig. 1151

With red or green lens (special purpose) add \$11.00 each.  
With amber lens in Sizes No. 1 and 2 only, add \$11.00 each.



Fig. 1152

### Stern Lights, Fig. 1152

135 DEGREE CLEAR LENS—12 POINT  
WITH FOUR LUGS FOR MOUNTING

No.	Galvanized Steel Each	Polished Brass Each	Lens Fig. 269 Height Inches	Height Less Handle Inches	Size Base Inches	C to C of Lugs Inches	Weight Each Pounds
1	\$ 57.50	\$ 71.00	6¾	11	7 x 7½	8¾	9
2	73.00	88.50	7½	13½	9 x10	10¾	12
3	121.50	142.50	8½	15¼	10¾x10¾	12¾	15

With red or green lens (special purpose) add \$11.00 each.  
With 45 degree red lens (for suction dredges) add \$15.00 each.  
With amber lens in Sizes No. 1 and 2 only, add \$11.00 each.

### Anchor Lights, Fig. 1153

360 DEGREE CLEAR LENS — 32 POINT  
WITH FOUR LASHING EYES AND WIRE GUARD

No.	Galvanized Steel Each	Polished Brass Each	Lens Fig. 261 Height Inches	Height Less Handle Inches	Diam. Base Inches	Weight Each Pounds
1	\$ 56.50	\$ 70.00	6¾	10¾	7¾	11
2	72.00	87.50	7½	12¾	9¾	16
3	120.00	141.00	8½	14¾	10½	22



Fig. 1153  
Fig. 1154

### Breakdown Lights, Fig. 1154

360 DEGREE RED LENS — 32 POINT  
WITH FOUR LASHING EYES AND WIRE GUARD

No.	Galvanized Steel Each	Polished Brass Each	Lens Fig. 261 Height Inches	Height Less Handle Inches	Diam. Base Inches	Weight Each Pounds
1	\$ 61.50	\$ 76.00	6¾	10¾	7¾	11
2	78.00	93.50	7½	12¾	9¾	16
3	129.00	150.00	8½	14¾	10½	22

#### NOTES

Above prices do not include bulbs.

For double filament bulbs see fig. 532.

With 2 medium screw phenolic sockets, sizes No. 2 and 3 only, add \$7.00 each.

With medium screw phenolic sockets fig. 346, deduct \$1.00 each.

Spare cast bronze watertight caps with gasket, diameter overall 5¾", diameter across thread 5", \$7.00 each.

COPPER LIGHTS MADE TO ORDER — ADD \$32.00 FOR EACH LIGHT TO ABOVE BRASS PRICES.

CHROMIUM PLATING TO ORDER — ADD \$12.50 FOR EACH LIGHT TO ABOVE BRASS PRICES.



**OIL NAVIGATION LIGHTS FOR VESSELS OVER 65 FT. LONG**

**American Improved Hinged Top—Bottom Opening**

SWIVEL FOUNT FIG. 282—HINGED BURNER FIG. 242

LIP CHIMNEY FIG. 267—FLAT WICK FIG. 302

**Side Lights, Fig. 1155**

112½ DEGREE RED AND GREEN LENSES—10 POINT—IN PAIRS  
WITH BRACKET FOR MOUNTING

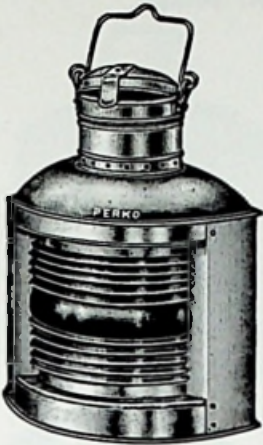

No.	Galvanized Steel Per Pair	Polished Brass Per Pair	Lens Fig. 259 Height Inches	Height Less Handle Inches	Size Base Inches	Weight Per Pair Pounds	For Size Vessel Feet
0	\$110.00	\$138.00	5½	13¾	6¾ x 6¾	14	65 to 90
1	115.00	142.00	6¾	14¾	7¼ x 7¼	18	90 to 150
2	146.00	177.00	7½	18	9½ x 9½	29	over 150
3	243.00	285.00	8½	19¾	10¾ x 10¾	38	over 150

Fig. 1155

**Masthead, Range and Towing Lights, Fig. 1156**

225 DEGREE CLEAR LENS—20 POINT  
WITH FOUR LUGS FOR MOUNTING

No.	Galvanized Steel Each	Polished Brass Each	Lens Fig. 256 Height Inches	Height Less Handle Inches	Size Base Inches	C to C of Lugs Inches	Weight Each Pounds
0	\$ 55.00	\$ 69.00	5½	13¾	7 x 7¼	8½	7
1	57.50	71.00	6¾	14¾	7½ x 7¾	8½	9
2	73.00	88.50	7½	18	9 x 10	10½	15
3	121.50	142.50	8½	19¾	10¾ x 11¼	12¾	21

With red or green lens (special purpose), add \$11.00 each.

With amber lens Sizes No. 0, 1 and 2 only, add \$11.00 each.

Fig. 1156

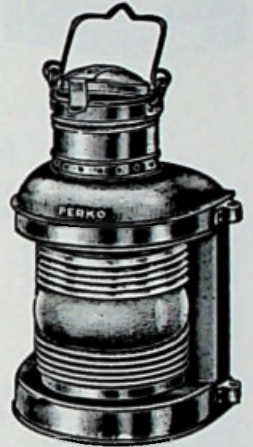

**Stern Lights, Fig. 1157**

135 DEGREE CLEAR LENS—12 POINT  
WITH FOUR LUGS FOR MOUNTING

No.	Galvanized Steel Each	Polished Brass Each	Lens Fig. 269 Height Inches	Height Less Handle Inches	Size Base Inches	C to C of Lugs Inches	Weight Each Pounds
0	\$ 55.00	\$ 69.00	5½	13¾	7 x 7¼	8½	6
1	57.50	71.00	6¾	14¾	7 x 7¼	8½	8
2	73.00	88.50	7½	18	9 x 10	10½	13
3	121.50	142.50	8½	19¾	10¾ x 10¾	12¾	16

With red or green lens (special purpose), add \$11.00 each.

With 45 degree lens (for suction dredges), add \$15.00 each.

With amber lens Sizes 0, 1 and 2 only, add \$11.00 each.

Fig. 1157



**Anchor Lights, Fig. 1158**

360 DEGREE CLEAR LENS—32 POINT  
WITH FOUR LASHING EYES AND WIRE GUARD

No.	Galv. Steel Each	Polished Brass Each	Lens Fig. 261 Height Inches	Height Less Handle Inches	Diam. Base Inches	Wt. Each Lbs.
0	\$ 54.00	\$ 68.00	5½	13	7¾	10
1	56.50	70.00	6¾	14	7¾	11
2	72.00	87.50	7½	17¼	9¾	17
3	120.00	141.00	8½	18¾	10½	23

**Breakdown Lights, Fig. 1159**

360 DEGREE RED LENS—32 POINT  
WITH FOUR LASHING EYES AND WIRE GUARD

No.	Galv. Steel Each	Polished Brass Each	Lens Fig. 261 Height Inches	Height Less Handle Inches	Diam. Base Inches	Wt. Each Lbs.
0	\$ 59.00	\$ 73.00	5½	13	7¾	10
1	61.50	76.00	6¾	14	7¾	11
2	78.00	93.50	7½	17¼	9¾	17
3	129.00	150.00	8½	18¾	10½	23



Fig. 1158  
Fig. 1159

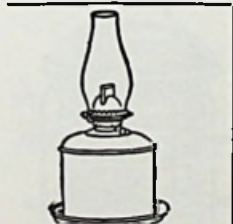

Oil Lamp used in Lights on this page

No. Each  
0 or 1 Comp. \$8.00  
2 or 3 Comp. 9.30

**ELECTRIC ONLY**

With Fig. 288 Medium Screw Adapter, use above prices.

With Fig. 289 Medium Screw Adapter, installed only in Sizes No. 2 and 3, add \$3.00 each.

With Fig. 1082 3 Wire Mogul Adapter, add \$3.25 each.

**COMBINATION OIL AND ELECTRIC**

With Fig. 288 Medium Screw Adapter, add \$5.00 each.

With Fig. 289 Medium Screw Adapter, installed only in Sizes, No. 2 and 3, add \$8.00 each.

With Fig. 1082 3 Wire Mogul Adapter, add \$8.25 each.

**COPPER LIGHTS MADE TO ORDER — ADD \$32.00 FOR EACH LIGHT TO ABOVE BRASS PRICES.**

**CHROMIUM PLATING TO ORDER — ADD \$12.50 FOR EACH LIGHT TO ABOVE BRASS PRICES.**



## ELECTRIC NAVIGATION LIGHTS FOR VESSELS OVER 65 FT. LONG

Flat Top Style — Bottom Opening

MEDIUM SCREW 2 WIRE PHENOLIC ADAPTER FIG. 288 FOR SINGLE FILAMENT BULBS



Fig. 30

### Side Lights, Fig. 30

112½ DEGREE RED AND GREEN LENSES — 10 POINT  
IN PAIRS—WITH BRACKET FOR MOUNTING

No.	Galvanized Steel Per Pair	Polished Brass Per Pair	Lens Fig. 259 Height Inches	Height Less Handle Inches	Size Base Inches	Weight Per Pair Pounds	For Size Vessel Feet
0	\$ 87.00	\$114.00	5½	10½	6½x6½	12	65 to 90
1	91.00	122.00	6¾	11	7½x7½	14	90 to 150
2	117.00	153.00	7½	13½	9½x9½	24	over 150

### Masthead, Range and Towing Lights, Fig. 983

225 DEGREE CLEAR LENS — 20 POINT  
WITH FOUR LUGS FOR MOUNTING

No.	Galvanized Steel Each	Polished Brass Each	Lens Fig. 256 Height Inches	Height Less Handle Inches	Size Base Inches	C to C of Lugs Inches	Weight Each Pounds
0	\$43.50	\$57.00	5½	10½	7 x 7	8½	6
1	45.50	61.00	6¾	11	7 x 7	8¾	8
2	58.50	76.50	7½	13½	9 x 9½	10%	12½

With red or green lens (special purpose), add \$11.00 each.  
With amber lens, add \$11.00 each.



Fig. 983

### Stern Lights, Fig. 986

135 DEGREE CLEAR LENS — 12 POINT  
WITH FOUR LUGS FOR MOUNTING



Fig. 986

No.	Galvanized Steel Each	Polished Brass Each	Lens Fig. 269 Height Inches	Height Less Handle Inches	Size Base Inches	C to C of Lugs Inches	Weight Each Pounds
0	\$43.50	\$57.00	5½	10½	7 x 7	8½	5½
1	45.50	61.00	6¾	11	7 x 7	8¾	7
2	58.50	76.50	7½	13½	9 x 9½	10%	9½

With red or green lens (special purpose) add \$11.00 each.  
With 45 degree red lens (for suction dredges) add \$15.00 each.  
With amber lens, add \$11.00 each.

### Anchor Lights, Fig. 32

360 DEGREE CLEAR LENS — 32 POINT  
WITH FOUR LASHING EYES AND WIRE GUARD

No.	Galvanized Steel Each	Polished Brass Each	Lens Fig. 261 Height Inches	Height Less Handle Inches	Diam. Base Inches	Weight Each Pounds
0	\$42.50	\$56.00	5½	9¾	7½	8
1	44.50	60.00	6¾	10¾	7½	9
2	57.50	75.50	7½	12¾	9¾	13

### Breakdown Lights, Fig. 84

360 DEGREE RED LENS — 32 POINT  
WITH FOUR LASHING EYES AND WIRE GUARD

No.	Galvanized Steel Each	Polished Brass Each	Lens Fig. 261 Height Inches	Height Less Handle Inches	Diam. Base Inches	Weight Each Pounds
0	\$47.50	\$61.50	5½	9¾	7½	8
1	50.50	66.00	6¾	10¾	7½	9
2	63.50	81.50	7½	12¾	9¾	13



Fig. 32

Fig. 84

#### NOTES

Above prices do not include bulbs.

With double 2 wire medium screw adapter fig. 289 (Size 2 only) add \$3.00 each.

With 3 wire mogul adapter fig. 1082 for double filament bulb, add \$3.25 each.

COPPER LIGHTS MADE TO ORDER — ADD \$32.00 FOR EACH LIGHT TO ABOVE BRASS PRICES.  
CHROMIUM PLATING TO ORDER — ADD \$12.50 FOR EACH LIGHT TO ABOVE BRASS PRICES.



## OIL NAVIGATION LIGHTS FOR VESSELS OVER 65 FT. LONG

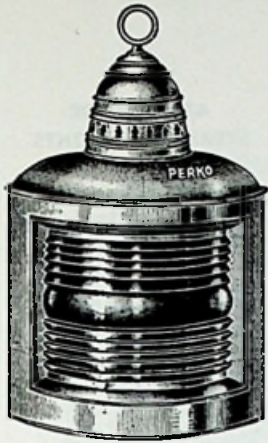

### Turret Top — Bottom Opening

SWIVEL FOUNT FIG. 282 — HINGED BURNER FIG. 242  
LIP CHIMMNEY FIG. 267 — FLAT WICK FIG. 302

### Side Lights, Fig. 21

112½ DEGREE RED AND GREEN LENSES — 10 POINT — IN PAIRS  
WITH BRACKET FOR MOUNTING

No.	Galvanized Steel Per Pair	Polished Brass Per Pair	Lens Fig. 259 Height Inches	Height Less Ring Inches	Size Base Inches	Weight Per Pair Pounds	For Size Vessel Feet
9	\$ 87.00	\$114.00	5½	14	6½x6½	13	65 to 90
10	91.00	122.00	6¾	15	7½x7½	15	90 to 150
11	117.00	153.00	7½	18¾	9½x9½	26	over 150

Fig. 21

### Masthead, Range and Towing Lights, Fig. 982

225 DEGREE CLEAR LENS — 20 POINT

WITH FOUR LUGS FOR MOUNTING

No.	Galvanized Steel Each	Polished Brass Each	Lens Fig. 256 Height Inches	Height Less Ring Inches	Size Base Inches	C to C of Lugs Inches	Weight Each Pounds
0	\$43.50	\$57.00	5½	14	7 x 7	8½	7½
1	45.50	61.00	6¾	15	7 x 7	8⅝	9½
2	58.50	76.50	7½	18¾	9 x 9½	10½	14

With red or green lens (special purpose), add \$11.00 each.  
With amber lens, add \$11.00 each.

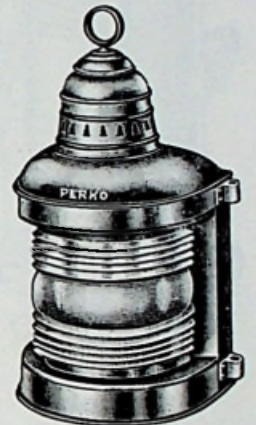

Fig. 982

### Stern Lights, Fig. 985

135 DEGREE CLEAR LENS — 12 POINT

WITH FOUR LUGS FOR MOUNTING

No.	Galvanized Steel Each	Polished Brass Each	Lens Fig. 269 Height Inches	Height Less Ring Inches	Size Base Inches	C to C of Lugs Inches	Weight Each Pounds
0	\$43.50	\$57.00	5½	14	7 x 7	8½	6
1	45.50	61.00	6¾	15	7 x 7	8⅝	7½
2	58.50	76.50	7½	18¾	9 x 9½	10½	10½

With red or green lens (special purpose) add \$11.00 each.  
With 45 degree red lens (for suction dredges) add \$15.00 each.  
With amber lens, add \$11.00 each.



Fig. 985

### Anchor Lights, Fig. 23

360 DEGREE CLEAR LENS — 32 POINT

WITH FOUR LASHING EYES AND WIRE GUARD

No.	Galvanized Steel Each	Polished Brass Each	Lens Fig. 261 Height Inches	Height Less Ring Inches	Diam. Base Inches	Weight Each Pounds
22	\$42.50	\$56.00	5½	13¾	7½	8½
22½	44.50	60.00	6¾	14½	7½	10
23	57.50	75.50	7½	17¾	9¾	14

### Breakdown Lights, Fig. 129

360 DEGREE RED LENS — 32 POINT

WITH FOUR LASHING EYES AND WIRE GUARD

No.	Galvanized Steel Each	Polished Brass Each	Lens Fig. 261 Height Inches	Height Less Ring Inches	Diam. Base Inches	Weight Each Pounds
22	\$47.50	\$61.50	5½	13¾	7½	8½
22½	50.50	66.00	6¾	14½	7½	10
23	63.50	81.50	7½	17¾	9¾	14

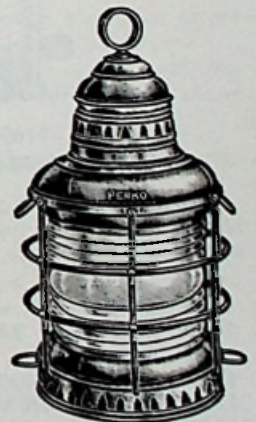

Fig. 23 or 129

#### ELECTRIC ONLY

With Fig. 288 Medium Screw Adapter, use above prices.  
With Fig. 289 Medium Screw Adapter, installed only in Sizes No. 2, 11 and 23, add \$3.00 each.  
With Fig. 1082 3 Wire Mogul Adapter, add \$3.25 each.

#### COMBINATION OIL AND ELECTRIC

With Fig. 288 Medium Screw Adapter, add \$5.00 each.  
With Fig. 289 Medium Screw Adapter, installed only in Sizes No. 2, 11 and 23 add \$8.00 each.  
With Fig. 1082 3 Wire Mogul Adapter, add \$8.25 each.

COPPER LIGHTS MADE TO ORDER — ADD \$32.00 EACH LIGHT TO ABOVE BRASS PRICES.  
CHROMIUM PLATING TO ORDER — ADD \$12.50 FOR EACH LIGHT TO ABOVE BRASS PRICES.



## TWO LENS NAVIGATION LIGHTS FOR SHIPS PER A.I.E.E. SPECIFICATION NO. 45 SECTION 34 PARAGRAPH 34.01 WATERTIGHT—ELECTRIC ONLY—CAST BRONZE U.S. COAST GUARD APPROVED

**SIDE LIGHTS**

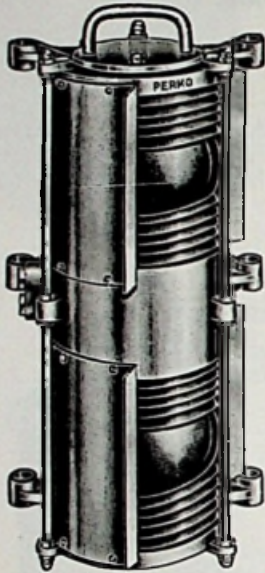

10 Point-112½°  
Fig. 1164

**MASTHEAD—RANGE  
& TOWING LIGHTS**

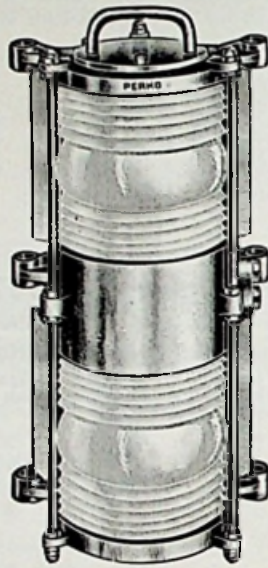

20 Point-225°  
Fig. 1165

**STERN LIGHTS**

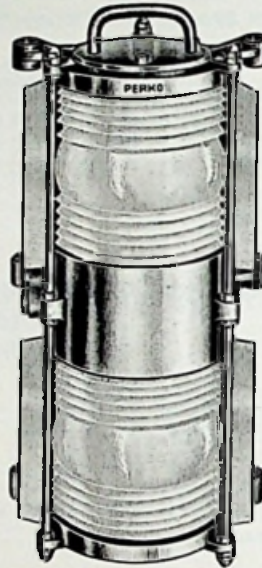

12 Point-135°  
Fig. 1166

**ANCHOR OR  
BREAKDOWN LIGHTS**

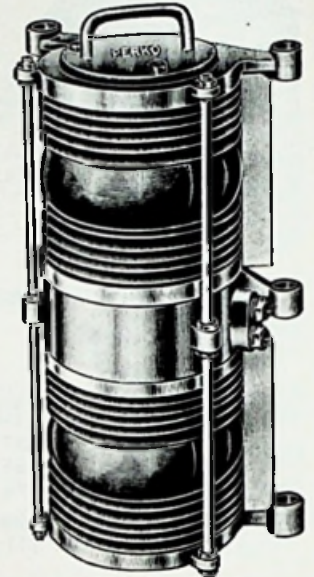

32 Point-360°  
Fig. 1167-Clear  
Fig. 1168-Red

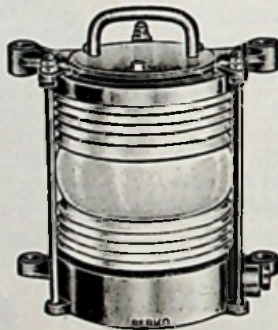

Fig. 1169-Clear Anchor Light  
Fig. 1170-Red Breakdown Light



Fig. 1171 Mounting Flange

All above two lens lights can be supplied with bronze quick action latch and platform at no extra charge.

Please specify when required.

Two individual lights in one body. Each section contains a Fresnel Lens, a medium screw phenolic socket for single filament lamp and a watertight cap for relamping or cleaning. A watertight terminal tube for cable entrance to each section and shields for light angle are included.

Fig.	Description	Price
1164	SIDE LIGHTS, with red lenses for port side, green lenses for starboard side	Per Pair \$260.00
1165	MASTHEAD, RANGE OR TOWING LIGHTS, with clear lenses	Each 125.00
1166	STERN LIGHTS, with clear lenses	Each 125.00
1167	ANCHOR LIGHTS, with clear lenses	Each 123.00
1168	BREAKDOWN LIGHTS, with red lenses	Each 130.00
*1169	ANCHOR LIGHTS, with clear lenses	Each 79.00
*1170	BREAKDOWN LIGHTS, with red lenses	Each 85.50

\* With shield for reduced light angles, (give degrees of light required) add \$11.00 each.  
FIGS. 1165 OR 1166 WITH COLORED LENSES, RED OR GREEN, ADD \$6.50 EACH

Spare Lenses Fig. 261 No. 1½	Colored Each	Spare Sockets Fig. 346 No. 2 Each	Spare Rubber Lens Gaskets Each	Height Less Handle Inches	Centers of Mounting Lugs Inches	Height Lens Inches	Weight Each Pounds
Clear Each	\$15.50	\$22.00	\$.70	\$3.00	**18½	8¾	6¾
							**30

\*\*Applies to two lens lights. Figs. 1169, 1170 Height 9 inches, Weight 15½ lbs.



## MARR VISIBLE SIGNAL WHISTLE LIGHT

Patent No. D 185,376 — Other Patents Pending

### AMBER PLASTIC LENSES—MIRROR REFLECTORS

RATED LIFE OF SEALED BEAM UNIT 2000 HOURS  
 500 WATT — 110,000 CANDLE POWER — 120 VOLTS  
 GALV. STEEL — ZINC CHROMATE UNDERCOAT AND GREY PAINTED FINISH  
 OR STAINLESS STEEL — NATURAL FINISH

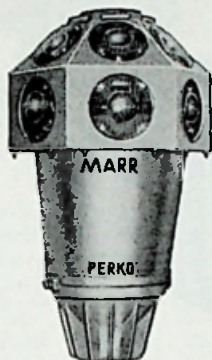

Fig. 1136 Type A-1



Fig. 1137 Type A-2

The MARR Visible Whistle Signal was developed because of the urgent need for such a device as emphasized by the increasing number of collisions of ships at sea, due to the failure of adjacent ships to hear or to properly interpret the audible whistle signals.

This is especially true since the adoption of Air Whistles on Diesel powered ships. In steam powered ships, the steam from the whistles can be clearly seen before the sound is heard and the ship signalling can be usually identified in the daytime, but even with steam in the night or in fog or mist, the steam whistle might be heard but would still be invisible.

The MARR Signal, equipped with multiple Amber Lenses, cannot be mistaken for any other light signal afloat or ashore. Its powerful rays are projected vertically directly toward the clouds, horizontal beams produced by periscopic type reflectors cover the horizontal area all around the horizon and additional Amber Lenses at an angle of 45 degrees encompass the space between the horizontal and vertical areas, thus covering in every direction an expanse never equalled by any other signalling light.

This Whistle Signal conforms exactly to the present "Rule No. 92.21 Visual Signal" in the "Pilot Rules" of the U. S. Coast Guard, which reads as follows:

-----"an amber colored light so located as to be visible all around the horizon for a distance of not less than **one mile**.

This light shall be so devised that it will operate simultaneously and in conjunction with the whistle sounding mechanism, and remain ignited or visible during the same period as the sound signal."

It will be noted that the above Rule requires visibility for only one mile while the MARR Signal provides visibility in every direction far in excess of the mile specified.

Fig.	Type	Galvanized Steel Each	Stainless Steel Each	Height Light Inches	Width Light Inches	Weight Pounds
1136	A-1	\$275.00	\$325.00	24	16	22
1137	A-2	325.00	380.00	28	18	28

### PULL SWITCH AND RELAY

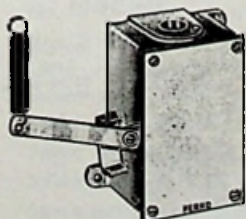

PULL SWITCH  
Fig. 1134

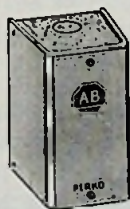

A.C. RELAY  
Fig. 1135

#### FOR MARR SIGNAL WHISTLE LIGHTS

Pull switch is underwriters approved and has cast bronze housing. A heavy duty double pole snap switch.

Each \$40.00

Relay is in an enclosure of enameled sheet metal, a double pole single throw switch operated by a solenoid type magnet. If D.C. relay required, please specify.

Each \$40.00

## SELF CONTAINED BATTERY NAVIGATION LIGHTS

For Oil Carriers, Barges, Scows, Etc.

### Watertight Type

FOR 2 No. 6 DRY CELLS IN SERIES—WITH SWITCH

Side Lights  
112½ Degrees



Fig. 1001

Masthead or  
Range Light  
225 Degrees

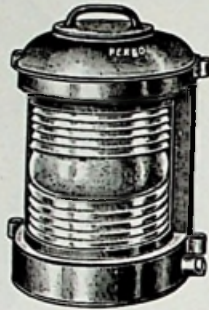

Fig. 1002

Stern  
Light  
135 Degrees



Fig. 1003

Standard No. 6 Dry  
Cells used with  
These Lights



	Fig. 1001		Fig. 1002		Fig. 1003		Fig.	DIMENSIONS			Weight Less Batteries Pounds
	Red and Green Per Pair	Clear Each	Amber Each	Clear Each	Amber Each	Height Lens Inches		Height Body Inches	Size Base Inches		
Galvanized	\$120.00	\$75.50	\$ 87.00	\$75.00	\$ 87.00	1001	6¾	11	7¼x7¼	18	
Pol. Brass	147.00	91.00	102.50	91.00	102.50	1002	7½	13½	9 x9½	15	
Spare Lenses	30.00	18.00	34.00	14.50	23.00	1003	7½	13½	9 x9½	12	

Above prices include bulbs, no batteries.

Spare bulbs, double contact 2.5 volts .15 amp. S-8 \$1.80 each.

### Waterproof Type

FOR 2 NO. 6 DRY CELLS IN SERIES WITH SWITCH

Side Lights  
112½ Degrees

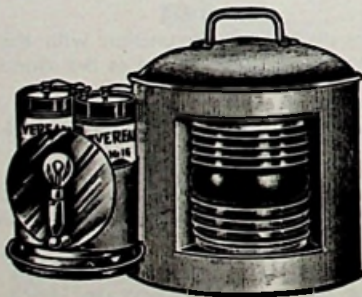

Fig. 1008

Masthead or  
Range Light  
225 Degrees



Fig. 1013

Stern  
Light  
135 Degrees



Fig. 1014

	Fig. 1008		Fig. 1013		Fig. 1014		Fig.	DIMENSIONS			Weight Less Batteries Pounds
	Red and Green Per Pair	Clear Each	Amber Each	Clear Each	Amber Each	Height Lens Inches		Height Body Inches	Size Base Inches		
Galvanized	\$96.00	\$66.00	\$77.00	\$66.00	\$77.00	1008	6¾	11	7¼x7¼	15	
Spare Lenses	15.00	18.00	34.00	14.50	23.00	1013	7½	13½	9 x9½	13	
						1014	7½	13½	9 x9½	10	

Above prices include bulbs, no batteries.

Bulb is double contact 2.5 volts .15 amp. S-8 \$1.80 each.

Battery containers as illustrated, complete with reflector, socket, bulb and switch, without batteries, \$17.00 each.





## 30 Day Battery ANCHOR LIGHT 360 DEGREE CLEAR FRESNEL LENS WATERPROOF—WITH SWITCH AND BULB

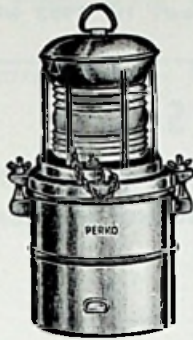

Fig. 470

For use with four standard 1½ volt dry cells such as Eveready No. 6, readily obtainable.

720 continuous hours of light on one set of batteries.

No.	Galvanized Steel Each	Polished Copper Each	Height Lens Inches	Height Overall Inches	Diam. Base Inches	Weight Pounds
1	\$42.00	\$50.00	4¼	15	6¾	5½
2	58.50	67.50	5½	16	6¾	7½

Spare parts and other information, see below.

## 60 Day Battery ANCHOR LIGHT 360 DEGREE CLEAR FRESNEL LENS WATERPROOF—WITH SWITCH AND BULB

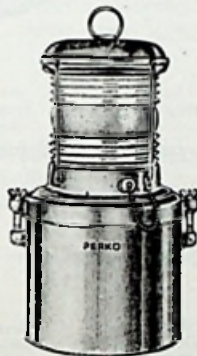

Fig. 474

Uses 6 standard 1½ volt No. 6 dry cells available anywhere.

Over 1500 hours continuous light on one set of batteries.

No.	Galvanized Steel Each	Polished Copper Each	Height Lens Inches	Height Overall Inches	Diam. Base Inches	Weight Pounds
3	\$72.00	\$84.00	5½	16	8½	8½

Figs 470 and 474—Spare parts and other data.

No. 1 Red, Green or Amber lens, add \$2.75 each.

Nos. 2 and 3 Red, Green or Amber lens, add \$7.00 each.

Light shielded to 112½, 135 or 225 degrees, add \$10.00 each.

Spare bulbs, 6 volt .04 amp. miniature base. \$.35 each.

Spare lenses, see fig. 261. Spare switches, see fig. 745.

Spare sockets, \$.25 each.

Spare battery containers, galvanized, \$12.50 each. Copper, \$16.00 each.

Spare socket holder with socket, \$2.00 each.

## Tri-Color TRAWLER LIGHTS FOR VESSELS UP TO 75 FEET

ELECTRIC ONLY—MEDIUM SCREW SOCKET  
45 DEGREE CLEAR FRESNEL LENS—4 POINT  
90 DEGREE RED AND GREEN FRESNEL  
LENSES—8 POINT  
WITH FIG. 131 BACK BRACKET  
BOTTOM OPENING—SPRING FOUNT



Fig. 408 — No. 0

Galv. Steel Each	Spare Lenses Each	Height Less Ring Inches	Height Lenses Inches	Weight Pounds
\$35.00	\$4.25	8½	5¾	3½

With bayonet double contact socket to order, same price as above.

With ventilated top for oil burning add \$6.00 each. For oil and electric, add \$7.75 each.

## VAPOR-PROOF FIXTURES

COMBINATION JUNCTION BOX  
CEILING AND BULKHEAD TYPE  
CAST BRONZE WITH 6" WIRE GUARDS  
AND SCREW GLASS GLOBES

Ceiling Type

Bulkhead Type



Fig. 1087



Fig. 1090

Fig.	Type	Each	For Lamp Wattage	Weight Pounds
1087	Keyless	\$15.50	60 to 100	3½
1090	Keyless	15.50	60 to 100	4

With Cast Bronze Guards, add \$2.00 to above prices.

Above fixtures have one ½" I.P.S. tapping. Extra tapping \$.50 per hole.



## “PERKO” Bridge and Pier LIGHTS

In strict accordance with specifications and regulations of the Treasury Department, U. S. Coast Guard, on marking and lighting of bridges. See “Aids To Navigation” C.G.-208 Subpart 68.15, January 1st, 1953 with amendments.

### Regulation PIER LIGHTS

For Piers, Axis, Abutments, Channel Sides, or Channel Margins. 180 Degree Red Fresnel Lens. Body of Sheet Steel or Sheet Brass. Electric Socket Is Phenolic Medium Screw, U.S.C.G. Approved.

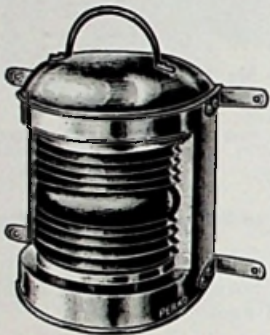

Fig. 29

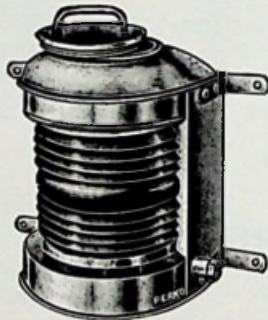

Fig. 31

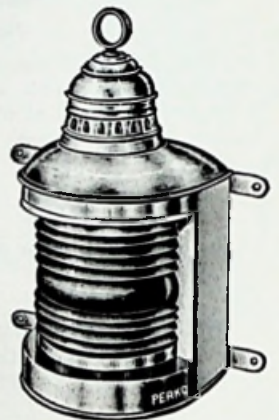

Fig. 59

FIG. 29—For electric only. With bottom opening and brass swivel electric adapter.

FIG. 31—Watertight, for electric only, with cast bronze threaded cap and brass packing gland for cable.

FIG. 59—For Oil only, Electric only, or Oil and Electric. Has bottom opening and brass swivel fount with burner, wick and chimney for oil, or brass electric adapter for electricity. Both supplied for “Oil and Electric.”

All above supplied with four brackets for mounting.

FIG.		Galv. Steel Each	Polished Brass Each	Height Lens Inches	*Height Overall Light Inches	Width Overall Inches	Size Base Inches	Weight Pounds
29	Electric only	\$73.00	\$90.00	7 $\frac{3}{8}$	13 $\frac{1}{4}$	14 $\frac{1}{2}$	9 $\frac{7}{8}$ x9 $\frac{1}{8}$	9
31	Electric only	81.00	98.00	7 $\frac{3}{8}$	13 $\frac{1}{4}$	14 $\frac{1}{2}$	9 $\frac{7}{8}$ x9 $\frac{1}{8}$	11
59	Oil or Electric	73.00	90.00	7 $\frac{3}{8}$	18	14 $\frac{1}{2}$	9 $\frac{7}{8}$ x9 $\frac{1}{8}$	13
59	Oil and Electric	78.00	95.00	7 $\frac{3}{8}$	18	14 $\frac{1}{2}$	9 $\frac{7}{8}$ x9 $\frac{1}{8}$	13

With Clear Lens for main channel markers on fixed bridges or with green or amber lens for special purpose, use above prices.

\*Height of light does not include handle or ring.

### Spare Parts

	Each		Each
Fresnel Lenses .....	\$25.00	Oil Fount .....	\$ 5.00
Mounting Brackets .....	1.40	Oil Burner .....	2.90
Electric Socket .....	.70	Oil Wicks .....	.10
Electric Adapter .....	5.00	Chimneys .....	1.38



## Regulation PIER LIGHTS

**Cast Bronze or Cast Aluminum — Emery Finish — Watertight For Piers, Axis, Abutments, Channel Sides or Channel Margins.**

**180 Degree Red Fresnel Lens.**

**Electric Only — With Phenolic Medium Screw Approved Socket.**



Fig. 125

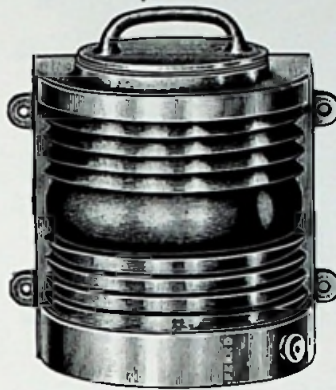

Fig. 1005

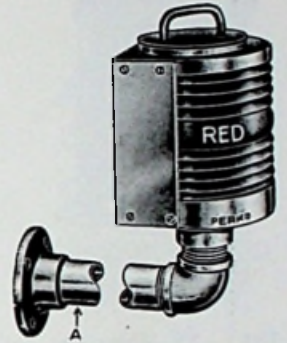

Fig. 1010

FIG. 1005—Has four integral mounting lugs drilled for  $\frac{3}{8}$  inch diameter bolt and brass packing gland for cable.

FIG. 125—This is fig. 1005 mounted on 1 inch brass pipe and good sturdy cast bronze flange. Brass packing gland for cable with 2 inch pipe and flange, add \$12.00 each.

FIG. 1010—This is fig. 1005 mounted on 2 inch brass pipe and fittings. Standard length of pipe "A" is  $3\frac{1}{2}$  inches. Special length, please specify, price on application.

FIG.	Cast Bronze Each	Cast Aluminum Each	Height Lens Inches	*Height Overall Light Inches	Width Light Inches	Size Base Inches	Weight Pounds	
							Bronze	Aluminum
1005	\$106.00	\$ 80.00	7 $\frac{3}{8}$	9 $\frac{1}{4}$	**9 $\frac{1}{4}$	8 $\frac{3}{8}$ x7 $\frac{3}{8}$	18	12
125	118.00		7 $\frac{3}{8}$	19	8 $\frac{1}{4}$	5	24	18
1010	146.00	120.00	7 $\frac{3}{8}$	17 $\frac{1}{2}$	8 $\frac{1}{4}$	6	28	22

With clear lens for main channel markers on fixed bridges or with green or amber lens for special purpose, use above prices.

\*Height of light does not include handle.

\*\*Width is to centers of mounting holes.

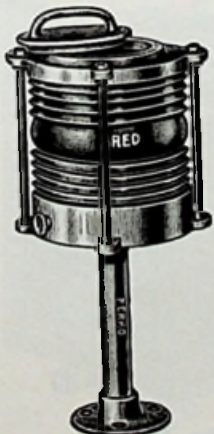

Fig. 126

## Special Purpose LIGHTS ON PEDESTAL

**With 360 Degree Red, Green, or Clear Lens.**

**For Sheer Booms, Isolated Piers, Obstructions, etc.**

**Cast Bronze — Emery Finish.**

**Watertight — Electric Only.**

Mounted on 1 inch brass pipe and good sturdy cast bronze flange. Has phenolic medium screw socket and brass packing gland for cable. Cast threaded cap.

Each	Height Lens Inches	*Height Overall Light Inches	Width Light Inches	Diam. Base Inches	Weight Pounds
\$120.00	7 $\frac{3}{8}$	19	11 $\frac{1}{2}$	5	24

This light can be supplied shielded to various degrees as required. Price on application.

\*Height of light does not include handle.

NOTE—Figs. 125, 126 and 1010 in special height other than standard, price on application.



## Regulation Swing, Draw or Folding BRIDGE LIGHTS

For Span of Through, Deck and Half Through Swing Bridges or Single Opening Draw Bridges with Alternate Red and Green 60 Degree Fresnel Lenses.

Socket is Phenolic Medium Screw, U.S.C.G. Approved.



Fig. 35

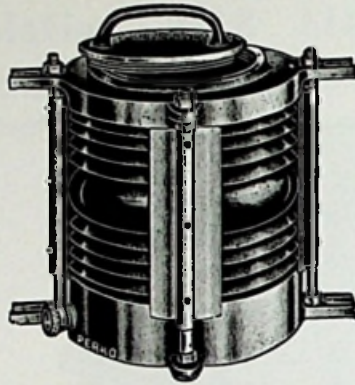

Fig. 39

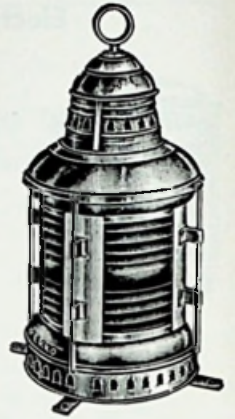

Fig. 50

- FIG. 35**—Watertight, for electric only. Made of sheet metal, either galvanized steel or brass with cast bronze threaded cap and brass packing gland for cable.
- FIG. 39**—Watertight, for electric only. Made of cast bronze or cast aluminum in emery finish. With cast threaded cap and packing gland for cable.
- FIG. 50**—For Oil, Electric or Oil and Electric. Made of sheet metal, either galvanized steel or brass. Has bottom opening and brass swivel fount with burner, wick and chimney for oil, or adapter for electricity. Both supplied for "Oil and Electric".

FIG.	Galv. Each	Polished Brass Each	Cast Bronze Each	Cast Aluminum Each	Spare Lenses Each	Height Lens Inches	*Height Overall Light Inches	**Width Overall Inches	Weight Pounds	
									Br.	Alum.
35 Elec. only	\$100.00	\$118.00			\$12.00	7 $\frac{3}{4}$	13 $\frac{1}{2}$	12 $\frac{1}{2}$	13 $\frac{1}{2}$	
39 Elec. only			\$130.00	\$110.00	12.00	7 $\frac{3}{4}$	9 $\frac{3}{4}$	11 $\frac{3}{4}$	22	15
50 Oil or Elec.	84.00	102.00			12.00	7 $\frac{3}{4}$	18	12 $\frac{1}{2}$	14	
50 Oil and Elec.	89.00	107.00			12.00	7 $\frac{3}{4}$	18	12 $\frac{1}{2}$	14 $\frac{1}{2}$	

\*Height of light does not include handle or ring.

\*\*Width includes mounting brackets.

## Box Type Regulation Draw SPAN LIGHTS

With 360 Degree Clear Fresnel Lens Enclosed by Alternate Red and Green Flat Glass Panels Showing 60 Degrees of Light

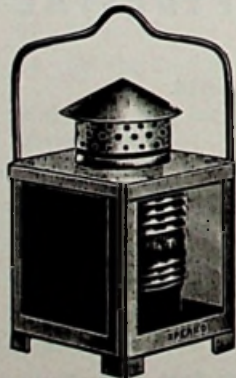

Fig. 63

**FIG. 63**—For Oil, Electric or Oil and Electric, made of Sheet Steel and Galvanized. Bottom opening with brass fount or adapter.

**FIG. 1007**—Watertight, for electric only. Made of cast bronze with threaded cap and packing gland.

FIG.		Galv. Each	Bronze Each	Spare Lens Each	Spare Panels Each
63	Oil or Elec.	\$ 95.00		\$18.00	\$4.40
63	Oil and Elec.	100.00		18.00	4.40
1007	Elec. only		116.00	18.00	4.40

Spare oil founts complete for Fig. 63, each \$12.60.

Spare electric adapter for Fig. 63, each \$11.00.

FIG.	Height Lens Inches	Height Less Handle Inches	Width Overall Inches	Dimensions of Panels Inches	Weight Pounds
63	7 $\frac{3}{4}$	18	11 $\frac{1}{4}$	9 $\frac{1}{2}$ x10 $\frac{3}{4}$	18
1007	7 $\frac{3}{4}$	12	12 $\frac{1}{2}$	9 x 9	48

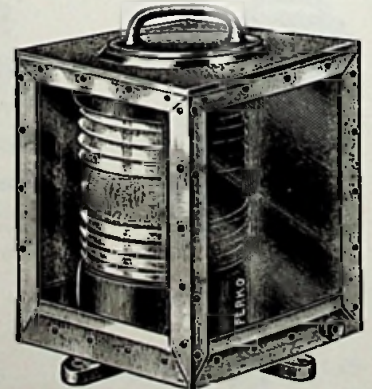
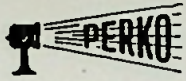

Fig. 1007

All lights on this page supplied with one lens or panel shielded for 3-way light (one red, two green) use above prices, please specify.



## Regulation Mid-Channel SPAN LIGHTS

For Fixed Bridges

360 Degree Green Fresnel Lens

Electric Socket Is Phenolic Medium Screw, U.S.C.G. Approved



Fig. 68

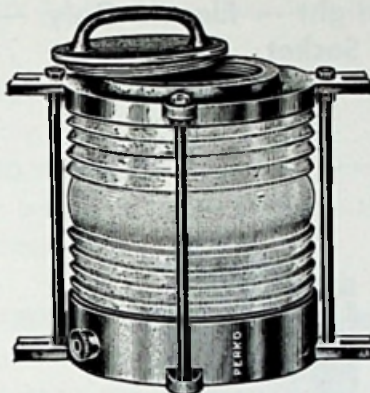

Fig. 1006



Fig. 80

- FIG. 68—For electric only, with bottom opening and brass swivel electric adapter. Made of sheet metal, either galvanized steel or brass.
- FIG. 1006—Watertight, for electric only. Made of cast bronze or cast aluminum in emery finish. With cast threaded cap and brass packing gland.
- FIG. 80—For oil only, electric only, or oil and electric. Made of sheet metal, either galvanized steel or brass. Has bottom opening and brass swivel fount with burner, wick and chimney for oil, brass electric adapter for electricity.

FIG.		Galvanized Steel Each	Polished Brass Each	Cast Bronze Each	Cast Aluminum Each	Height Lens Inches	*Height Overall Light Inches	Width Overall Inches	Weight Pounds	
									Br.	Alum.
68	Electric only	\$58.50	\$76.50			7 $\frac{3}{8}$	14 $\frac{1}{2}$	9 $\frac{1}{2}$	13	
1006	Electric only			\$110.00	\$95.00	7 $\frac{3}{8}$	9 $\frac{1}{2}$	11 $\frac{3}{8}$	21	14
80	Oil or Elec	73.00	88.50			7 $\frac{3}{8}$	18	9 $\frac{3}{4}$	17	
80	Oil and Elec.	78.00	93.50			7 $\frac{3}{8}$	18	9 $\frac{3}{4}$	17	

With clear, or red lens for special purpose, use above prices.

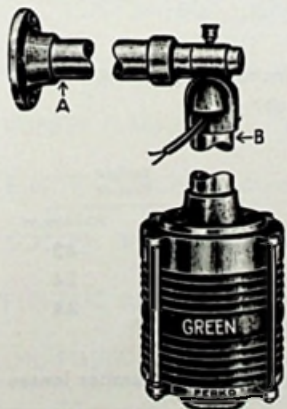

Fig. 1011

## Regulation Mid-Channel SPAN LIGHTS with Pivot Mounting

Cast Bronze or Cast Aluminum — Emery Finish  
Watertight — Electric Only — Medium Screw Socket  
360 Degree Green Fresnel Lens

This is Fig. 1006 with pivot mounting allowing light to be seen beneath the bridge yet can be swung to the upper level for rebulbing or cleaning. Entrance is through cast threaded cap in bottom of light body. Pipe is brass, 2 inch size. Standard length at "A" and "B" is 2 inches. Flanges and other fittings are cast bronze.

Cast Bronze Each	Cast Aluminum Each	Height Lens Inches	*Height Overall Inches	Width Overall Inches	Weight Pounds	
					Bronze	Aluminum
\$210.00	\$180.00	7 $\frac{3}{8}$	20 $\frac{1}{4}$	11 $\frac{1}{2}$	36	29

NOTE—With special length of pipe at "A" or "B", price on application.

\*Height does not include handle.



## Lift SPAN LIGHTS For Bascule Bridges

For Single and Double Lift Bridges. 180 Degree Red and Green Fresnel Lenses. Cast Bronze or Cast Aluminum — Emery Finish — Watertight — Electric Only — Medium Screw Socket



Fig. 22

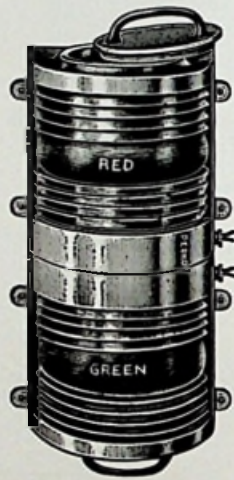

Fig. 127



Fig. 1012

FIG. 22—Swinging type with fixed extension. Pipe is brass, 2 inch size, 6 inches long. Bracket is cast bronze. Light contains two bakelite medium screw sockets, one for each lens. Entrance for rebulbing or cleaning is through two 4½ inch openings, one in back of upper section, the other in bottom of lower section, both closed by threaded cast caps. Complete with brass grease cup.

FIG. 127—Fixed type, has eight integral mounting lugs, drilled for ¾ inch diameter bolt. Two brass packing glands for cable and two threaded caps for entrance to each section.

FIG. 1012—Swinging type with pipe extension; pipe "A" and "B" is brass, 2 inch size, 2 inches long at "A" and 6 inches long at "B". Other fittings are cast bronze. Light is the same as Fig. 22 above.

FIG.	Cast Bronze Each	Cast Aluminum Each	*Height Overall Inches	Height Lens Inches	Width Light Inches	Size of Bracket Inches	Weight Pounds	
							Bronze	Aluminum
22	\$250.00	\$200.00	30½	7¾	8½	6¼x6¼	54	42
127	200.00	150.00	18½	7¾	**9¼		36	24
1012	350.00	180.00	32	7¾	8½	6	56	44

NOTE—Supplied in special color combinations if required, such as two red or two green lenses also clear or amber lenses at above prices.

Special length of pipe at "A" or "B", price on application.

\*Height does not include handle.

\*\*Width is to centers of mounting holes.



**LIGHT COLORS AND HORIZONTAL ARCS OF VISIBILITY  
IN ACCORDANCE WITH "AIDS TO NAVIGATION"  
REGULATIONS ON LIGHTING FOR BRIDGES**



**180 DEGREE RED**—For piers, axis, abutments, channel sides or channel margins.



**180 DEGREE CLEAR**—For main channel markers on fixed bridges.



**360 DEGREE RED, GREEN OR CLEAR**—For sheer booms, isolated piers and obstructions not part of the bridge or bridge approach structure. May be shielded to various degrees as required.



**60 DEGREE ALTERNATE RED AND GREEN**—For draw span of draw bridges or swing span of through swing bridges. When required for swing span of deck or half-through swing bridges, one red lens is shielded.



**360 DEGREE GREEN**—For mid-channel or channel center, for span of fixed bridge over a navigable channel.



**180 DEGREE GREEN AND RED**—For span of single and double-lift bascule bridges. Green when lift span is fully open for navigation, red for all other positions of lift span.

**SPARE PARTS FOR BRIDGES AND PIER LIGHTS**

180 DEGREE LENSES—For figs. 22-29-31-59-125-127-1005-1010-1012	Clear <b>\$18.25</b> each, Colored <b>\$25.00</b> each
360 DEGREE LENSES—For figs. 68-80-126-1006-1011	Clear <b>\$18.00</b> each, Colored <b>\$27.50</b> each
CAST BRONZE WATERTIGHT CAPS complete with rubber gasket—For figs. 22-31-35-39-125-126-127-1005-1006-1007-1010-1011-1012	<b>\$7.00</b> each
RUBBER GASKETS—For caps	<b>\$ .35</b> each
RUBBER GASKETS—For 360 degree lenses	<b>\$3.00</b> each
ELECTRIC SOCKETS—Medium screw—For all lights	<b>\$ .70</b> each
SOCKET SUPPORTS—Brass—For all watertight electric lights	<b>\$1.30</b> each
ELECTRIC ADAPTER—For figs. 29-50-59-68-80	<b>\$5.00</b> each
OIL FOUNTS—Brass—For figs. 50-59-80	<b>\$5.00</b> each
OIL BURNERS—Brass—For above founts	<b>\$2.90</b> each
OIL WICKS—For above burners	<b>\$ .10</b> each
CHIMNEYS—For above burners	<b>\$1.38</b> each

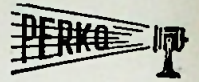

## AUTHENTIC MARINE TABLE LAMPS

ALL SOLID BRASS—WITH ATTRACTIVE FIBRE GLASS SHADES

Presenting an attractive assortment of table lamps designed for those who have a natural love for the sea and vessels that sail upon it, and who desire a nautical atmosphere or motif in their surroundings, be it their home, boat, office, club or eating place.

Manufactured and designed by this country's oldest and most highly regarded manufacturer of navigation lights, these lamps are the real thing, not imitations.

All lenses are true molded fresnels made to government requirements for navigational purposes, in light transmission and color. Colors (Red, Green, Blue or Amber) are molded into the lens, not coated or painted.

All wired and complete with plug.

"Nautilus"

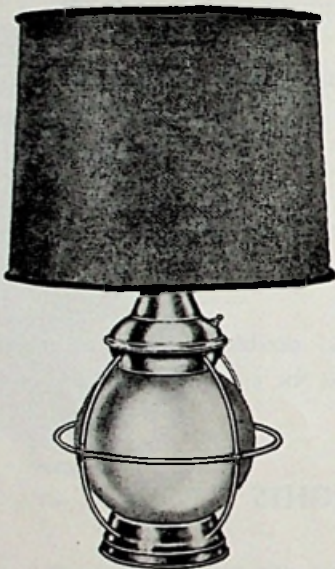

Fig. 1210

"Corsair"

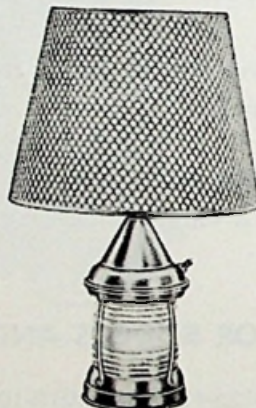

Fig. 1211

"Neptune"



Fig. 1212

Equipped with three way turn switch for light under shade, inside globe or both.

Fig.	Lamp Only Less Shade—		Shade Only Each	Height Inches	Diam. Base Inches	Size of Shade Inches	Size of Globe Inches	Weight Pounds
	Polished Brass Each	Chromium Plated Each						
1210	\$40.00	\$48.00	\$10.00	24½	5¾	13x14x12	8	4½
1211	22.50	25.50	6.00	15	4¼	7x10x 8	3¾	2½
1212	27.00	31.00	9.75	19¼	5¾	10x14x10	4¼	3

### SHADE SPECIFICATIONS

- Fig. 1210 Both Finishes—blue burlap over fibre glass, white cotton rope trim top and bottom.
- Fig. 1211 Polished Brass—green fish net over fibre glass, gold trim top and bottom.
- Fig. 1211 Chromium Plated—blue fish net over fibre glass, white trim top and bottom.
- Fig. 1212 Both Finishes—white linen over fibre glass, red trim top and bottom.

**NOTE—ABOVE LAMPS SHIPPED COMPLETE WITH SHADE UNLESS OTHERWISE SPECIFIED.**

Height shown above is from base to top of shade. Sizes of shade shown above are 1st, diameter of top, 2nd, diameter of bottom; 3rd, height.

Prices shown above apply to Fig. 1210 with white frosted globe, Figures 1211 or 1212 with clear fresnel lenses.

Fig. 1210 with colored globe (red, green or blue) add \$4.25 each.

Fig. 1211 with colored lens (red, green or amber) add \$1.00 each.

Fig. 1212 with colored lens (red, green or amber) add \$1.80 each.





**AUTHENTIC MARINE TABLE LAMPS**

ALL SOLID BRASS — WITH ATTRACTIVE FIBRE GLASS SHADES

**"Mariner"**



**Fig. 1213**

**"Voyager"**



**Fig. 1214**

**"Seafarer"**

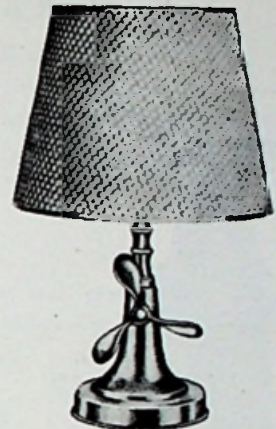

**Fig. 1215**

Fig.	Lamp Only Less Shade		Shade Only Each	Height Inches	Diam. Base Inches	Size of Shade Inches	*Diameter Wheel Inches	Weight Pounds
	Polished Brass Each	Chromium Plated Each						
1213	\$26.00	\$28.75	\$6.00	15¼	5¼	7x10x8	4¾	3
1214	21.50	24.50	6.00	15¼	5¼	7x10x8		3
1215	21.50	24.50	6.00	15¼	5¼	7x10x8		3

**SHADE SPECIFICATIONS**

**Figs. 1213, 1214, 1215** Polished Brass—green fish net over fibre glass, gold trim top and bottom.

**Figs. 1213, 1214, 1215** Chromium Plated—blue fish net over fibre glass, white trim top and bottom.

**NOTE—ABOVE LAMPS SHIPPED COMPLETE WITH SHADE UNLESS OTHERWISE SPECIFIED.**

Sizes of shade shown above are 1st, diameter of top; 2nd, diameter of bottom; 3rd, height.

\* Diameter of wheel is measured from end to end of handles.

**Ship's Masthead Light House Fixture**

**MEDIUM SCREW ELECTRIC SOCKET  
FLAT BACK FOR WALL MOUNTING**

Has Glass Dome Bottom for illumination below.

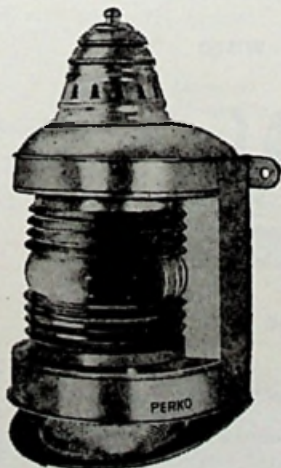
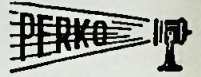

**Fig. 1034**

No.	Polished Brass Each	Chromium Plated Each	Height Light Inches	Width Light Inches	Height Lens Inches	Weight Pounds
1	\$57.50	\$65.00	14	7	5½	7½
2	78.00	88.00	18¾	9	7½	14

Colored lenses. Red, Green or Amber, add \$11.00 to above prices.

Antique or bank bronze finish price on application.



## MARINE HOUSE FIXTURES—ALL BRASS

MEDIUM SCREW ELECTRIC SOCKET, ALL WIRED

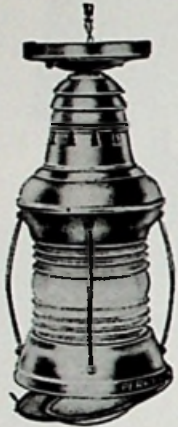

**FLUSH CANOPY**  
Fig. 1023

No.	Polished Brass Each	Chromium Plated Each
1	\$18.00	\$22.50
2	20.50	25.00

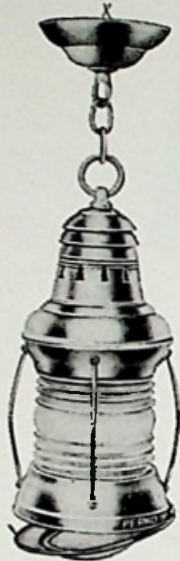

**CANOPY AND CHAIN**  
Fig. 1024

No.	Polished Brass Each	Chromium Plated Each
1	\$18.50	\$23.00
2	21.00	25.50



**WALL BRACKET**  
Fig. 1025

No.	Polished Brass Each	Chromium Plated Each
1	\$20.00	\$24.50
2	22.50	27.00



**CANOPY and CHAIN**  
**WHITE FROSTED GLOBE**  
Fig. 1032

No.	Polished Brass Each	Chromium Plated Each
1	\$30.00	\$35.50
2	33.00	38.50
3	64.00	72.00

No.	Height Lamp Only Inches	Diam. Lamp Inches	Height Lens Inches	Approx. Weight Pounds
1	8 $\frac{3}{8}$	4 $\frac{1}{2}$	3 $\frac{3}{8}$	3
2	11 $\frac{1}{4}$	5 $\frac{1}{2}$	4 $\frac{1}{4}$	4

**COLORED LENSES**  
Red - Green - Amber

No.	Add Each
1	\$2.00
2	2.40

No.	Height Lamp Only Inches	Diam. Globe Inches	Approx. Weight Pounds
1	11	6	3
2	14	8	4 $\frac{1}{2}$
3	16 $\frac{1}{2}$	10	6 $\frac{1}{2}$

With colored globe No. 1—Red or blue No. 2 and 3—Red, Green or blue. Add \$2.00 each.

### Authentic Ship's Bulkhead Lantern House Fixture

CLEAR GLASS PANELS

MEDIUM SCREW ELECTRIC SOCKET



Fig. 1045

No.	Dimensions Inches	Galv. Steel Each	Polished Brass Each
1	7x 9 $\frac{1}{2}$ x13	\$35.00	\$45.00
2	9x13 x17	37.00	47.00

### Oil Lamp Converter

ALL BRASS — WIRED



Fig. 58

A combination chimney holder and medium screw size electric receptacle. For chimney to fit, see Fig. 94.

Each \$4.50



## Junior CABIN LAMP

Double Swing—Weighted Base  
All Brass

Fig. 168

Same construction as our well known Newport Cabin Lamp Fig. 141, but reduced in size for use where space or headroom is limited.

No.	Polished Brass Each	Chromium Plated Each	Overall Height Inches	Extension Inches	Capacity Fount Pints	Weight Ounces
0	\$13.25	\$17.00	9	5	½	19

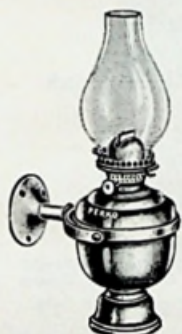

## Newport CABIN LAMP

Double Swing—Weighted Base  
All Brass

Fig. 141

This lamp is of very sturdy construction, refined appearance and minimum practical extension from wall. Diameter of wall plate 2½ inches.

No.	Polished Brass Each	Chromium Plated Each	Overall Height Inches	Extension Inches	Capacity Fount Pints	Weight Pounds
1	\$13.75	\$17.50	10½	5½	1	1¾
2	15.75	19.75	12½	6	1¼	2

### SPARE PARTS FOR CABIN LAMPS

No.	Each
0 and 1 Spare Burners Fig. 231	\$ .90
0 and 1 Spare Chimneys Fig. 230	.75
2 and 4 Spare Burners Fig. 242 No. 2	2.90
2 and 4 Spare Chimneys Fig. 267 No. 2	1.38

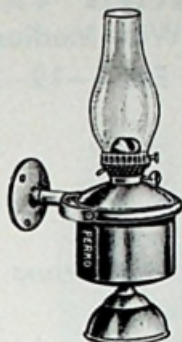

## Philadelphia CABIN LAMP

Double Swing—Weighted Base  
Removable Fount—All Brass

Fig. 137

With 2½ inch diameter wall plate, hinge burner Fig. 242 No. 2 and 6 inch chimney Fig. 267 No. 2.

No.	Polished Brass Each	Chromium Plated Each	Overall Height Inches	Extension Inches	Capacity Pints	Weight Pounds
4	\$16.00	\$18.00	14	8½	1½	3¾



## Universal WALL LAMP

Tin Plate or Brass

Fig. 312

Has polished reflector and gives excellent illumination. Uses No. 2 size wick.

Tin Each	Polished Brass Each	Spare Chimneys Each	Spare Burners Each	Height of Back Inches	Diam. of Fount Inches	Weight Pounds
\$6.30	\$8.60	\$1.30	\$1.00	9	5	1½

## SMOKE BELL AND ARM

All Brass



Fig. 128

No.	Polished Brass Each	Chromium Plated Each	Diam. Bell Inches	Extension to Center Inches	Weight Ounces
0	\$3.50	\$4.75	3½	3½	3½
1	3.50	4.75	4	3¾	4
2	3.50	4.75	4	4	4
4	3.75	5.00	6¼	6½	7

No. 0 size is for lamp Fig. 168.

No. 1 and 2 sizes are for lamp Fig. 141.

No. 4 size is for lamp Fig. 137.



## Electric CABIN FIXTURES

With Medium Screw Sockets

For 6-12-32 or 110 Volts



### Streamline Pattern

Zamak Die Casting—Chromium Plated  
With Turn Switch

Fig. 217

Chromium Plated Each	Size Base Inches	Drop Less Lamp Inches	Depth Less Lamp Inches	Weight Ounces
\$2.50	2½x2¼	2¼	2½	8

Spare socket with switch, \$.95 each.



### Square Base Pattern

Cast Bronze—With Toggle Switch

Fig. 450

Polished Bronze Each	Chromium Plated Each	Size Base Inches	Drop less Lamp Inches	Projection less Lamp Inches	Weight Ounces
\$5.00	\$5.50	2x2	2	2½	12

Spare interior with switch, \$1.00 each.

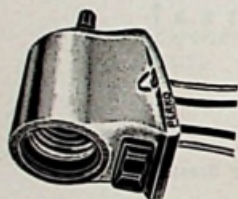

### Streamline Pattern

With Power Takeoff Receptacle for  
Electric Razor and Appliances  
Zamak Die Casting  
Chromium Plated  
Has Turn Switch

Fig. 1295

Chromium Plated Each	Size Base Inches	Drop Less Lamp Inches	Depth Less Lamp Inches	Weight Ounces
\$2.90	2½x2¼	2¼	2½	8½

Spare socket with switch \$.95 each.

Spare power receptacle \$.40 each.

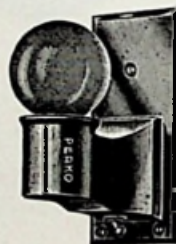

### Upright Pattern

Cast Bronze—With Toggle Switch

Fig. 304

Polished Bronze Each	Chromium Plated Each	Size Plate Inches	Projection Less Lamp Inches	Weight Ounces
\$7.25	\$8.00	4½x2½	2½	17

Spare interior with switch, \$1.00 each.



### Upright Pattern

Zamak Die Casting—Chromium Plated  
With Turn Switch

Fig. 225

Chromium Plated Each	Size Base Inches	Length Overall Inches	Projection Less Lamp Inches	Weight Ounces
\$3.65	3⅞x2⅞	5⅞	2¼	10

Spare socket with switch, \$.95 each.

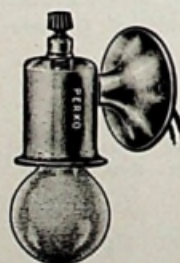

### Round Base Pattern

Spun Brass—With Turn Switch

Fig. 308

Polished Brass Each	Chromium Plated Each	Diam. Base Inches	Drop less Lamp Inches	Projection less Lamp Inches	Weight Ounces
\$3.50	\$4.25	2½	2½	3	6

Spare socket with switch, \$.95 each.

PRICES ON THIS PAGE DO NOT INCLUDE BULBS. WHEN ORDERING BULBS, SPECIFY VOLTAGE AND CANDLEPOWER, FROSTED OR CLEAR. ABOVE FIXTURES ARE SUPPLIED NOT WIRED.



## CABIN FIXTURE

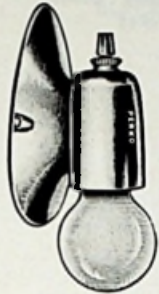

Fig. 1237

### Oval Base Pattern

Zamak Die Casting—Chromium Plated  
With Turn Switch

Chromium Plated Each	Size Base Inches	Drop Less Lamp Inches	Projection Less Lamp Inches	Weight Ounces
\$3.30	4½x1½	4½	2¾	6

Spare socket with switch, \$.95 each.

## Marine SHIELDS For Fixtures

Parchment Paper  
Hand Painted or Plain



For Hanging Bulb  
Fig. 27

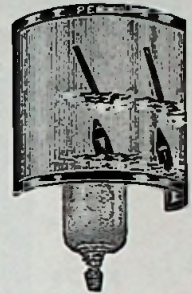

For Upright Bulb  
Fig. 28

A marine design hand painted in colors makes these shields very decorative and appropriate for a yacht state-room, cabin, club or marine room.

Metal clip is for a bulb up to 60 watts.

Painted Each	Plain Each	Width Inches	Depth Inches	Weight Ounces
2.50	\$1.95	4	3¾	1½

## "Tear-Drop" FIXTURE

Chromium Plated  
Double Contact Socket—Turn Switch



Front View

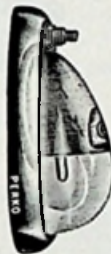

Side View

Fig. 301

An attractive fixture for cabin or berth. Has streamlined thick glass globe and supplied with 6 volt 21 C.P. bulb.

Complete Each	Spare Globe Each	Spare Socket Each	Spare Bulb Each	Overall Size Inches	Depth Inches	Weight Ounces
\$6.20	\$1.00	\$.50	\$.40	5x3	1¾	11

Spare Switches, \$.90 each.

Spare Gaskets, \$.30 each.

## WATERTIGHT DOME LIGHT

Cast Bronze—Double Contact Socket  
With Threaded Diffusing Globe

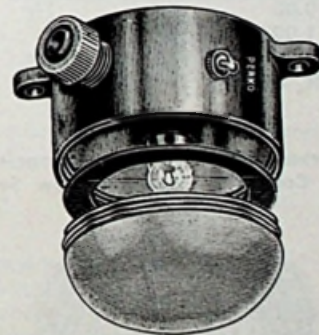

Fig. 1266

For small boats. Will accommodate up to a 50 C.P. No. RP-11 bulb. With nickel plated reflector, toggle switch and one packing gland for cable.

Plain Bronze Each	Polished Bronze Each	Chromium Plated Each	Extreme Diam. Inches	Diam. Globe Inches	Extreme Depth Inches	Weight Pounds
\$13.50	\$15.00	\$17.00	3½	3¾	2¾	1¾

Spare Sockets, \$.60 each.

Spare Globes, \$1.00 each.

Extra Packing Glands installed, \$2.00 each gland

## DASHBOARD LAMP

Brass—Nickel Plated  
Double Contact Socket—With Switch



Fig. 184

Bulb is not included.

Each	Height Overall Inches	Size Base Inches	Weight Ounces
\$1.25	2¾	1½x1½	1½



## DOMES LIGHTS

Wrought Brass—With Fig. 257 Diffusing Glass  
Toggle Switch—Double Contact Socket



Fig. 294

Diam. Glass Inches	Chromium Plated Each	Diam. Base Inches	Depth Overall Inches	Weight Ounces
3	\$ 8.75	4¼	2	6
4	10.00	5½	2¼	9
5	11.00	6½	2½	15
6	13.25	7½	2¾	20

Spare sockets, see fig. 747, No. 2.

## DOMES LIGHTS

Wrought Brass—With Fig. 257 Diffusing Glass  
Push Switch—Double Contact Socket

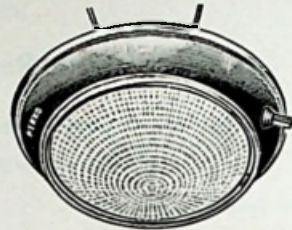

Fig. 383

Diameter Glass Inches	Chromium Plated Each	Diameter Base Inches	Depth Overall Inches	Weight Ounces
3	\$6.75	4½	1⅝	6
4	7.50	5½	1¾	9
5	8.00	6¾	2	13

Spare sockets, see fig. 747, No. 2.

## DOMES LIGHTS

Wrought Brass—With Fig. 132 Frosted Glass  
Toggle Switch—Double Contact Socket



Fig. 296

Diam. Glass Inches	Chromium Plated Each	Diam. Base Inches	Depth Overall Inches	Weight Ounces
3	\$ 8.75	4¼	1⅝	5½
4	10.00	5½	1¾	8½
5	11.00	6½	2	12
6	13.25	7½	2⅝	15

Spare sockets, see fig. 747, No. 2.

## DOMES LIGHTS

Cast Bronze—With Toggle Switch  
With Fig. 257 Ribbed Diffusing Glass



Fig. 555

No. 1 has Fig. 747 double contact socket and will accommodate a 50 C.P. bulb.

No. 2 has Fig. 346 medium screw socket and will accommodate a 15 watt A-17 bulb Fig. 340 or any listed size of Fig. 8.

No.	Chromium Plated Each	Diam. Glass Inches	Diam. Base Inches	Depth Inches	Weight Pounds
1	\$13.50	4	5½	1¾	1¼
2	23.50	6	7⅞	3½	3¾

## DOMES LIGHTS

Wrought Brass—With Opal Globe—Toggle Switch  
Double Contact or Medium Screw Socket

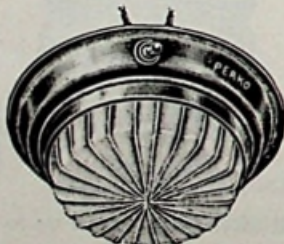

Fig. 385

With Fig. 747 No. 2 Double Contact Socket

No.	Chromium Plated Each	Diam. Base Inches	Diam. Globe Inches	Depth Inches	Weight Ounces
7	\$10.50	6	4¼	2⅝	12
8	12.00	7	5¾	2¾	15

With Fig. 346 Medium Screw Socket

9	\$12.50	7	5¾	2¾	16
---	---------	---	----	----	----

Bulb with medium screw base for this light, see Fig. 8.  
Spare globes, see Fig. 133.

## DOMES LIGHTS

Wrought Brass—With Toggle Switch  
With Nickel Plated Reflector  
Frosted Glass Fig. 132—Medium Screw Socket Fig. 346

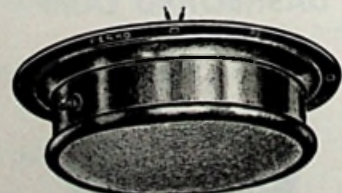

Fig. 753

Will accommodate a bulb up to 100 watts.

Chromium Plated Each	Diam. Base Inches	Diam. Glass Inches	Depth Overall Inches	Weight Pounds
\$21.00	9¾	8	3	2

SPARE TOGGLE SWITCHES FOR ALL ABOVE LIGHTS, SEE FIG. 745



## SWITCH PANELS

BLACK BAKELITE PANELS — ENGRAVED WHITE LETTERING — BRASS, CHROMIUM PLATED SWITCHES

### 5 GANG PANEL



Fig. 517

Our stock panel is illustrated. Dealer or user may change name plates as desired as they are removable. For additional selection see Fig. 519. For changes made at factory, add \$1.00 each.

With Fuse Holders Each	Without Fuse Holders Each	With Fuse Holders Size Inches	Without Fuse Holders Size Inches
\$14.50	\$9.00	6½x4¼	6½x3¾

Supplied with fuse holder unless otherwise specified.

### STARTER AND IGNITION PANEL 2 POINT PUSH BUTTON STARTER SWITCH LOCK TYPE IGNITION SWITCH—TWO KEYS



Fig. 518

Visible portion of all switches is chromium plated.

Complete Each	Length Inches	Width Inches	Weight Ounces
\$6.25	4½	2½	5

### STARTER—IGNITION—LIGHTS PANEL 2 POINT PUSH BUTTON STARTER SWITCH LOCK TYPE IGNITION SWITCH—TWO KEYS BRASS TOGGLE TYPE LIGHT SWITCH

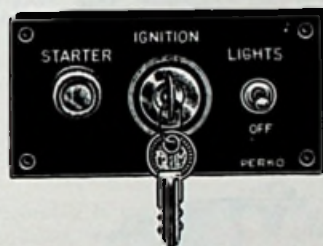

Fig. 514

Visible portion of all switches is chromium plated.

Complete Each	Length Inches	Width Inches	Weight Ounces
\$7.50	5	2½	8

### SPARE PARTS

Ignition Switches, see Fig. 316.  
Toggle Switches, see Fig. 745.  
Starter Switches, see Fig. 255, all Brass.  
Fuse Holders, enclosed type, \$1.00 each.

## Switch NAME PLATES

BLACK BAKELITE—ENGRAVED WHITE LETTERING

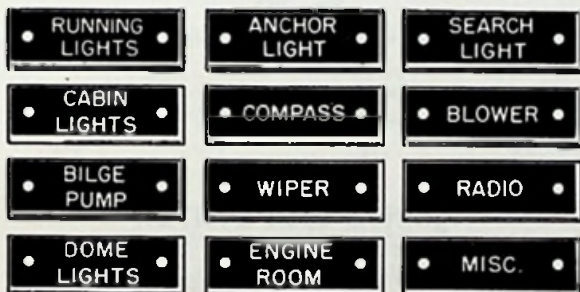

Fig. 519

In addition to those illustrated, stock name plates are:

Bow Light	Master	Spreader Light
Choke	Masthead Light	Stbd. Light
Deck Lights	Neutral	Starter
Fan	Off	Stern Light
Flood Lights	On	Switch
Forward	Panel Lights	Throttle
Fuel Pump	Pilot	Towing Lights
Heater	Port Light	6 Volt
Horn	Range Light	12 Volt
Ignition	Reverse	32 Volt
Lights	Siren	110 Volt
Fuel	Tachometer	

Per Dozen	Length Inches	Width Inches	Screw Size No.	Weight Per Dozen Ounces
\$4.80	1½	½	4	½

Packed one dozen each name per box.

Less than one dozen each name \$ .60 each.

Special name plates, price on application. Specify lettering and size.

## NAME PLATE KIT

Transparent Plastic Box  
Contains 6 Dozen Assorted  
Fig. 519 Name Plates

Per Kit — \$25.75

### CONTENTS

½ dozen each - Anchor Lights - Bilge Pump - Blower - Cabin Lights - Compass - Fan - Running Lights - Misc. - Horn - Ignition - Starter - Searchlight.



Fig. 480



## Improved Push and Pull SWITCHES ALL BRASS THROUGHOUT — 3/4 INCH KNOB

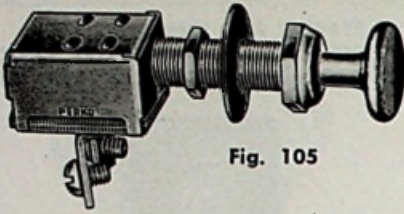

Fig. 105

No.	Chromium Plated Each	Diam. Neck Inches	For Wood Thickness Inches	Length Overall Inches	Diam. Knob Inches	Weight Ounces
1	\$1.25	3/8	1	3	3/4	2
2	1.40	3/8	1 1/4	3 1/4	3/4	2 1/2

## Improved Push and Pull SWITCHES WITH FACE PLATE ALL BRASS THROUGHOUT — 3/4 INCH KNOB

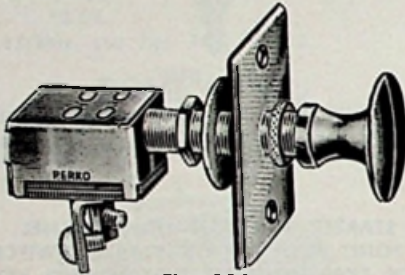

Fig. 216

No.	Chromium Plated Each	Diam. Neck Inches	For Wood Thickness Inches	Diam. Knob Inches	Size Face Plate Inches	Weight Ounces
1	\$1.40	3/8	1	3/4	1 1/4 x 1	2 1/2
2	1.55	3/8	1 1/4	3/4	1 1/2 x 1	3

## Toggle SWITCH ALL BRASS THROUGHOUT SCREW POSTS—NO LEADS

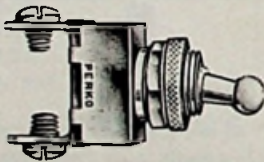

Fig. 688

Nickel Plated Each	Length Neck Inches	Diam. Neck Inches	Between Lock Nuts Inches	Weight Ounces
\$ .95	7/16	3/16	3/4	7/8

## TOGGLE SWITCH with Face Plate BRASS WITH BAKELITE INSULATION SCREW POSTS—NO LEADS



Fig. 718

Chromium Plated Each	Size Face Plate Inches	Weight Ounces
\$1.10	1 1/4 x 1	3/4

## Toggle SWITCHES BRASS WITH BAKELITE INSULATION WITH 6 INCH WIRE LEADS

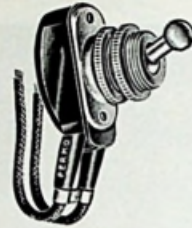

Fig. 745

No.	Nickel Plated Each	Length Neck Inches	Diam. Neck Inches	Between Lock Nuts Inches	Weight Ounces
1	\$ .75	3/16	3/16	3/8	5/8
2	.80	3/16	3/16	3/8	3/4

No. 2 supplied unless otherwise specified.  
With watertight cap and chain, add \$1.00 each.

## Momentary Starter SWITCH OR DASHBOARD HORN BUTTON PUSH BUTTON TYPE—ALL BRASS

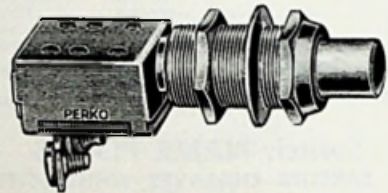

Fig. 255

2 point, 2 terminal spring action switch with chromium plated button.

Each	Diameter Neck Inches	For Wood Thickness Inches	Weight Ounces
\$1.60	3/8	1	2 1/2

## Ignition Lock SWITCH 30 AMP. 6 VOLTS—15 AMP. 12 VOLTS 2 TERMINAL—2 KEYS

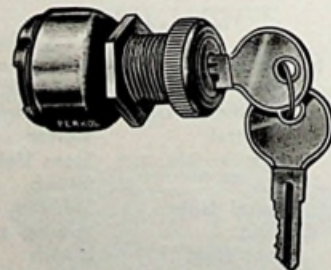

Fig. 316

Brass lock, switch, terminal screws and lock nut. Face plate is chromium plated.

No.	Each	Diameter Neck Inches	Length Neck Inches	Weight Ounces
1	\$2.15	3/4	3/4	4
2	2.90	1 1/4	1 1/4	4 1/2





**Knife or Battery SWITCHES**

EBONY ASBESTOS BASE—HIGH JAWS  
ONE OR TWO POLE  
SINGLE OR DOUBLE THROW  
250 VOLT D.C.—500 VOLT A.C.

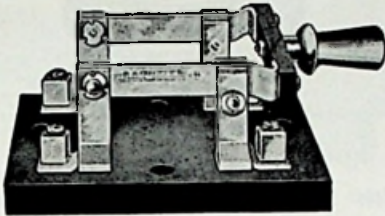

Fig. 191

**SINGLE POLE—SINGLE THROW**

No.	Each	Amps.	Dimensions Base Inches	Weight Pounds
1	\$ 4.35	60	6 3/4 x 1 3/8 x 3/8	3/4
2	8.70	100	6 3/4 x 2 x 3/4	2 1/2
3	15.25	200	10 x 3 x 1	4

**SINGLE POLE—DOUBLE THROW**

4	6.95	60	9 1/4 x 2 x 3/4	2 1/2
5	16.00	100	10 x 3 x 3/4	4
6	24.95	200	12 x 4 x 1	8

**DOUBLE POLE—SINGLE THROW**

7	6.70	60	6 x 4 1/2 x 3/8	3
8	13.00	100	7 1/2 x 5 x 3/4	3
9	23.25	200	9 1/2 x 6 x 1	10 1/4

**DOUBLE POLE—DOUBLE THROW**

10	10.30	60	9 1/2 x 6 x 3/4	5 1/2
11	25.00	100	10 1/4 x 7 x 3/4	8 1/2
12	36.60	200	15 x 7 3/4 x 1	16

**SAFETY MAIN SWITCH**

RED BAKELITE HOUSING—VAPOR PROOF  
MULTIPLE POLE



Fig. 85

300 AMPS. IN 6 VOLT.

150 AMPS. IN 12 VOLT.

A heavy duty marine switch completely sealed in a bakelite housing.

Flashing arcs common in open type knife switches are eliminated by this enclosed unit.

No corrosive materials used anywhere in this switch. Contacts are heavy gauge copper. Springs, set screws, etc. are stainless steel.

Used for connecting one or more batteries and shutting off all electricity at the source.

Snap action of knob helps positive control of switch when operating same in dark location.

Supplied for flush mounting. Battery cable passes through bulkhead.

Each	Diameter Inches	Depth Inches	Weight Ounces
\$12.50	4 3/4	1 3/8	5

If offset mounting is required, permitting cable to pass in back of housing, we supply a set of offset legs 1/2 inch long. Per set \$.50.

**New Lock Type IGNITION-STARTER SWITCH**

ALL BRASS  
3 Terminal — 2 Keys

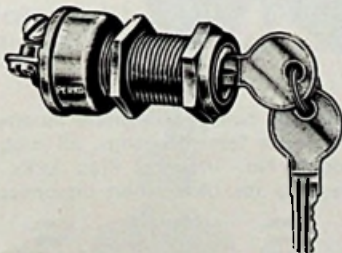

Fig. 310

3 position switch—OFF - IGNITION - START  
Returns automatically from start to ignition position.

Face nut is chromium plated, springs are stainless steel.

Each	Diameter Neck Inches	Length Neck Inches	Weight Ounces
\$3.50	3/4	1 1/8	4 1/2

**New 3 Position PUSH AND PULL SWITCH**

ALL BRASS  
3 Terminal — 1/2" Chrome Knob

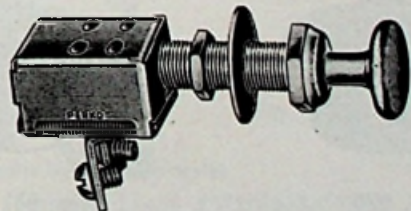

Fig. 381

3 position switch—OFF - ON - ON  
First "on" position energizes one circuit. Second "on" position energizes all circuits.

Each	Diam. Neck Inches	For Wood Thickness Inches	Length Overall Inches	Weight Ounces
\$1.85	3/8	1	3 1/2	3



## RECEPTACLES and PLUGS

YACHT SIZE—VOLTAGE 6 TO 125  
WATERTIGHT—CAST BRONZE BOXES

ROUND FLUSH TYPE WITHOUT BOX  
5 AMP. — 2 WIRE



Fig. 968

Complete With Plug Each	Plug Only Each	Diam. Plate Inches	Depth Inches	Weight Pounds
\$16.00	\$5.25	2¼	¾	½

ROUND FLUSH TYPE WITH BOX  
5 AMP. — BOTTOM INLET — 2 WIRE

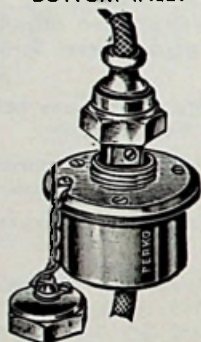

Fig. 969

Complete With Plug Each	Plug Only Each	Diam. Plate Inches	Diam. Box Inches	Depth Inches	Weight Pounds
\$19.00	\$5.25	2¼	1¾	1¼	¾

HEAVY DUTY TYPE — 10 AMP. — 2 WIRE

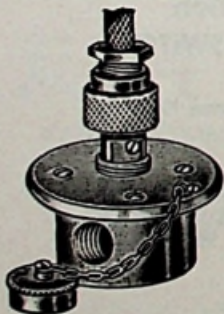

Fig. 970  
Flush Type

Fig. 970 Complete Each	Fig. 971 Complete Each	Plugs Only Each
\$19.50	\$18.50	\$5.25

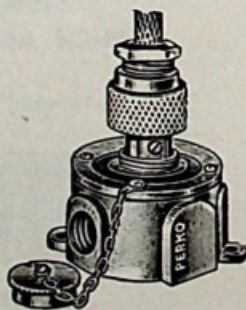

Fig. 971  
Surface Type

Diam. Plate Fig. 970 Inches	Diam. Box Fig. 971 Inches	Weight Fig. 970 Pounds
3½	2¾	1¾

## Watertight SNAP SWITCH

FLUSH TYPE OR SURFACE TYPE  
CAST BRONZE—10 AMP. 2 WIRE

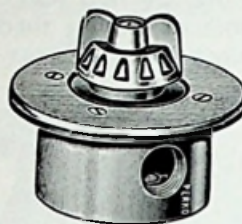

Fig. 974

Ratchet under knob to prevent turning in wrong direction.

	Flush Type	Surface Type	Diam. Plate Inches	Diam. Box Inches	Depth Box Inches	Weight Pounds
Single Pole	\$16.75	\$14.50	4	3	1½	2

## Watertight Connection Box

CAST BRONZE — SURFACE TYPE

With 4 wire phenolic connection block and rubber gasket.

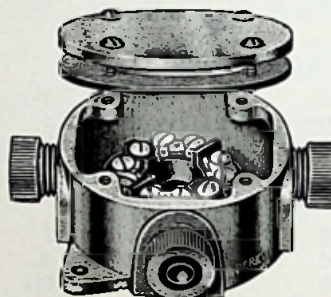

Fig. 1252

Complete Each	Spare Blocks Each	Inside Diam. Inches	Inside Depth Inches	Weight Pounds
\$9.50	\$2.00	3	1¾	1¾

Price does not include packing glands in illustration.

## Ship to Shore CONNECTOR

110 VOLTS — 25 AMPS.  
ALL BRASS METAL PARTS

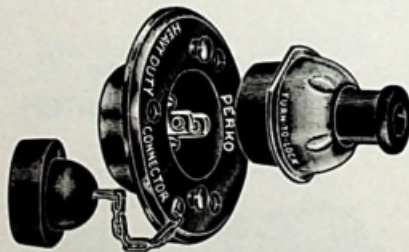

Fig. 72

Bakelite base has heavy duty male terminals. Plug is phenolic with bronze female prongs, all rubber covered. Will accommodate No. 10 wire. Plug locks in base. A chained rubber cap for base when disconnected.

Complete Each	Diam. Base Overall Inches	Depth of Base Inches	Diam. Hole Required Inches	Weight Ounces
\$3.20	3¾	¾	1¾	5

Plug complete with female interior, each \$2.00.  
Spare female plug interior only, each \$0.90.

NOTE: ALL BOXES HAVE ONE ½" I.P.S. TAPPING. EXTRA TAPPINGS ADD \$.50 FOR EACH HOLE.  
PACKING GLANDS FOR ABOVE \$1.25 EACH.  
CHROMIUM PLATED FINISH SUPPLIED TO ORDER, PRICE ON APPLICATION.



## Watertight CONNECTION

ALL BRASS — DOUBLE CONTACT

Deck Socket

Plug



Fig. 423



Fig. 425

**DECK SOCKET.** All brass, double contact, complete with threaded cap and chain as illustrated.

**PLUG.** All brass, double contact, threaded lock nut for fastening to deck socket, Fig. 423. Threaded cap with rubber gasket inside to prevent water running down cable.

	Chromium Plated Each	Dimensions Inches
Socket Only	\$3.50	1½x1¾
Plug Only	2.75	1½x1

Spare electric sockets only, see fig. 747, No. 2.

## Watertight CONNECTION

ALL BRASS — DOUBLE CONTACT



Fig. 477

Complete as illustrated, with rubber grommet inside cap for cable.

Chromium Plated Each	Composition Interiors Only Per Set	Size Inches
\$3.50	\$3.65	1½x1¼

## Watertight CABLE OUTLET

ALL BRASS — FOR ¾ INCH CABLE



Fig. 424

Has rubber grommet for watertight passage of cable through deck or bulkhead, also prevents chafing of cable insulation.

Chromium Plated Each	Extreme Diameter Inches
\$1.50	1¼

## New "Lek Heart" FUSE PANEL

BAKELITE — BRASS METAL PARTS  
WHITE PLASTIC ENCLOSURE



Fig. 676

Marine engineered for all small power craft, inboard and outboard.

Complete with display card and instructions. For glass fuses—6 or 12 volts.

Dimensions of panel 4" x 3".  
Each \$4.50

## FUSE PANEL

BAKELITE—BRASS METAL PARTS  
FOR GLASS FUSES UP TO 30 AMP.



For two active fuses and one spare.

Each	Dimensions Inches	Length Fuse Inches
\$.85	2¼x1¾x¾	1¼

Fig. 694

## Boat TRAILER LIGHT

CHROMIUM PLATED  
2—CELL FLASHLIGHT CASE  
RED SHATTER-PROOF LENS  
ADJUSTABLE SCREW TYPE CLAMP

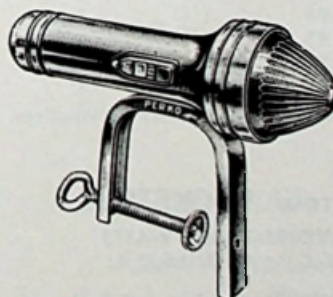

Each	Length Overall Inches	Weight Ounces
\$4.60	8¾	13

Fig. 143

Price includes bulb, no batteries.

## Fused Line CONNECTOR

MOLDED BAKELITE  
WITH 20 AMP. FUSE AND WIRE LEADS



Fig. 786

FOR STANDARD GLASS FUSES 1¼ INCHES LONG

Each	Length Inches	Diameter Inches	Weight Ounces
\$.50	2½	¾	¾



## Medium Screw SOCKETS PORCELAIN—250 VOLTS—660 WATTS



Fig. 222

No.	Complete Each	Gaskets Only Each	Height Inches	Size Base Inches	C to C of Slots Inches
1	\$.90	\$.12	1 5/8	2 x 1 1/4	1 1/2

## Electric Socket ADAPTERS



Fig. 405

For converting various types of sockets.

No.	Each
650—From Bayonet Dble. Contact to Med. Screw	\$.80
670—From Med. Screw to Bayonet Dble. Contact	1.10
680—From Med. Screw to Bayonet Single Contact	1.10
830—From Med. Screw to Foreign Bayonet D.C.	1.20
X12—From Mogul to Medium Screw	1.20

## Bayonet Double Contact SOCKETS

BRASS CASE—TAPPED 1/8 INCH I. P. S.



Fig. 276

Used in our De-Lite motor boat lights, classes 1, 2 and 3, and various types of dome lights.

No.	Each	Length Overall Inches	Weight Per Dozen Ounces
0	\$.95	1 3/4	7
1	.95	1 5/8	8
2	.95	2	11
3	.95	2 3/8	14

Size No. 2 available in single contact, price on application.

## Medium Screw SOCKETS

PHENOLIC—250 VOLTS—660 WATTS  
APPROVED BY U.S.C.G. AND U.S.M.A.

With 1/8 or 3/8 inch I. P. S. thread.



Fig. 346

No.	Each	Size Thread Inches
1	\$.70	1/8
2	.70	3/8

No.	Height Inches	Extreme Diameter Inches	Weight Dozen Pounds
1	1 1/4	1 3/4	1
2	1 3/4	1 3/4	1

## Bayonet Double Contact SOCKETS BRASS CASE—HARD RUBBER INSULATION



Fig. 747

No.	Each	Length Inches	Weight Dozen Ounces
1	\$.60	7/8	5
2	.60	1	5
6	.75	1 1/2	8
7	.90	2	9

Outside diameter, all sizes, 1 1/8 inches.

No. 1 Wires enter side, screws in bottom.

No. 2 Wires enter bottom, screws in same side.

Nos. 6, 7 Wires enter side, screws in bottom.

Note—No. 1 used in lights Figs. 563, 1138, 1140, etc.

No. 2 used in pole lights, dome lights, etc.

No. 6 used in class 2 side and bow lights.

No. 7 used in class 3 side and bow lights.

Single contact available, price on application

## Navy Standard Electric SOCKETS

PHENOLIC INSULATION—BRONZE PARTS



Candelabra Screw

Fig. 15

Complies with Navy drawing 9-S-2036-L.

Each	Height Inches	Size Base Inches	Weight Dozen Ounces
\$1.10	1 1/8	1 x 1 1/2	12

## Bayonet SOCKETS

PHENOLIC—SINGLE AND DOUBLE CONTACT

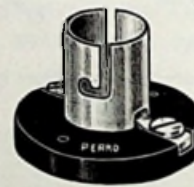

Fig. 472

No.	Each	Type	Height Inches	Diam. Base Inches	Weight Dozen Ounces
20	\$1.15	Double contact	1	1 3/8	9
21	1.15	Single contact			

## Mogul 3 Wire SOCKET PHENOLIC—NAVY DRAWING 9-4779-L 600 VOLTS—1500 WATTS

For use with double filament bulb Fig. 532.



Fig. 270

Each	Height Inches
\$4.00	2 3/4

Outside Diam. Inches	C to C of Mounting Holes Inches	Weight Ounces
2 1/4	1 3/4	6

With white metal mounting cap tapped 3/8 inch I. P. S. add \$.35 each.



## Brass CABLE STRAPS FOR CABLE, TUBING, CONTROL WIRE ETC.



Fig. 121

Inside Diam. Inches	Per 100	Length Inches	Width Inches
1/8	\$2.70	1 1/4	1/2
3/16	3.00	1 3/8	1/2
1/4	3.25	1 3/8	1/2
5/16	3.25	1 3/8	1/2
3/8	3.60	1 3/8	1/2
7/16	3.90	1 3/8	1/2
1/2	4.20	1 1/2	1/2
5/8	5.00	1 3/4	1/2
3/4	5.50	1 3/4	1/2

Supplied in boxes of 100 pieces.

## Line SUPPORT CLIPS

ALUMINUM

WITH SYNTHETIC RUBBER CUSHION

Used in the aircraft industry for supporting electrical, fuel, instrument, oil and water lines.



Fig. 163  
Single



Fig. 164  
Double



Fig. 165  
Triple

For O.D. Line Inches	FIG. 163 Per 100	FIG. 164 Per 100	FIG. 165 Per 100	Width Inches
3/16	\$ 8.00	\$13.30	\$17.25	3/8
1/4	8.25	13.30	18.00	3/8
5/16	8.75	13.50	20.00	1/2
3/8	8.75	14.25	21.50	1/2
1/2	10.00	16.00	24.60	1/2

Supplied in Boxes of 100 Pieces

## Bayonet Double Contact ADAPTER BRASS AND HARD RUBBER



Fig. 355

For adapting oil fount to electricity. Screw adapter in place of oil burner and punch hole in bottom of fount for cable entrance.

Each	Length Overall Inches	Diam. Thread Inches	Weight Dozen Ounces
\$1.20	1 1/4	7/8	8

## New 4-Prong CONNECTOR

BAKELITE BODY—SOFT RUBBER CAPS  
SCREW TERMINALS—ALL BRASS

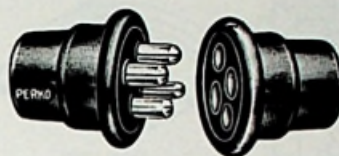

Each	Length Overall Inches	Diameter Overall Inches
\$1.60	2	1 1/8

Fig. 751

Excellent for boat trailer electrical hookups.

## Double Contact CONNECTORS

HARD RUBBER INSULATION—BRASS CONTACTS  
WITH SOFT RUBBER WATERPROOF CAPS

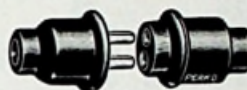

Each	Size Inches	Weight Dozen Ounces
\$.75	1 1/8 x 2 1/2	10

Fig. 749

## "Midget" CONNECTORS

BAKELITE BODY—BRASS CONTACTS  
DOUBLE CONTACT

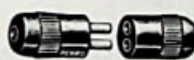

Each	Size Inches	Weight Dozen Ounces
\$1.35	3/16 x 1 3/8	6

Fig. 26

Designed for use in limited space. Split pins insure a firm positive connection.

## DOUBLE CONTACT CONNECTORS

HARD RUBBER INSULATION—BRASS CONTACTS

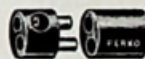

Each	Size Inches	Weight Dozen Ounces
\$.45	1 x 3/16	6

Fig. 42

## Bayonet Double Contact PLUG

HARD RUBBER PLUG

SOFT RUBBER WATERPROOF CAP



Fig. 746

With flush type contact screws, used with sockets Figs. 276, 472, 747.

Each	Length Inches	Diam. Inches	Weight Dozen Ounces
\$.50	1 1/2	1 5/16	8



## FRESNEL LENSES

FOR SIDE AND COMBINATION LIGHTS  
112½ DEGREES

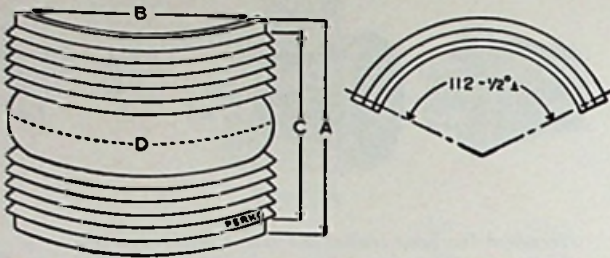

Fig. 259

For Motor Boats	A In.	B In.	C In.	D In.	Clear Each	Red or Green Each	Amber Each
Class A-L.J.	1¾	1¾	1⅞	1¾		\$1.10	
Class A Std.	2½	1⅞	2½	3		1.70	
*Class A-P	2½	2	2	2½		.95	
Class A Rocket	1⅞	2½	1⅞	3		1.20	
Class 1	3¾	2¾	2¾	3¾		2.50	\$2.60
Class 2	4¼	3¾	3⅞	4¼	\$3.45	3.45	
Class 3	5¾	3⅞	4¾	5¾		4.35	

For Vessels Over 65 ft.

No. 8	5½	4⅞	4⅞	5¾		7.50	
No. 0 or 9	5½	5¾	5	8¾	10.50	10.50	
No. 1 or 10	6¾	6	6	8¾		15.00	
No. 2 or 11	7½	8½	6¾	11¾		20.00	
No. 3	8½	9¾	7¾	13		23.00	

Class A-L.J. For Figs. 1146-1247.

Class A-Std. For Figs. 416-1140-1147.

\*Class A-P for Figs. 1160-1205-1218-1232-1235-1236-1274.

Class A Rocket For Fig. 1260.

FOR ANCHOR LIGHTS—360 DEGREES

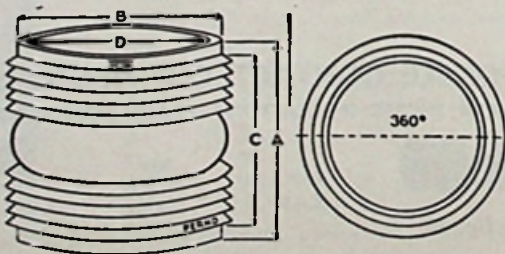

Fig. 261

For Motor Boats	A In.	B In.	C In.	D In.	Clear Each	Colored Each
Junior	3¾	3¾	2¾	2¾	\$2.50	\$3.35
Senior	4¼	4	3¾	3¾	3.35	5.00

For Vessels Over 65 Ft.

No. 0 or 22	5½	5½	5	4¾	10.50	18.00
No. 1 or 22½	6¾	5¾	6¾	4½	15.50	23.00
No. 1½	6¾	6	6	5¾	17.00	24.50
No. 2 or 23	7½	7½	6¾	6½	18.00	27.50
No. 3	8½	8½	7¾	7½	23.00	36.50

Colors are red, green, blue or amber.

Sizes Senior, No. 1 and 2 not available in blue.

Sizes No. 1½ and 3 not available in blue or amber.

\* This lens is a high grade acrylic plastic.

DIMENSIONS SUBJECT TO GOVERNMENT STANDARD TOLERANCES—PLUS OR MINUS

FOR BOW LIGHTS—180 DEGREES

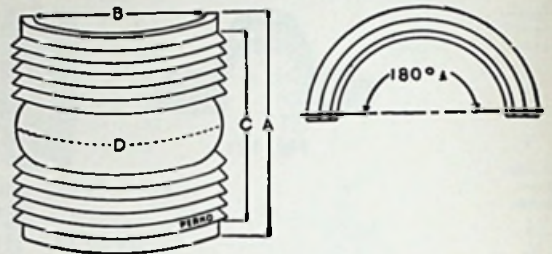

Fig. 260

For Motor Boats	A In.	B In.	C In.	D In.	Clear Each	Colored Each
Class 1	3¾	2¾	2¾	5¾	\$3.35	\$5.80
Class 2	4¼	3¾	3¾	6¾	3.45	5.95
Class 3	5¾	3¾	4¾	7⅞	4.35	7.25
Mld. 59	7¾	6¾	6¾	12½	18.25	25.00

Colors are red, green, blue or amber.

Mld. 59 not available in blue.

Mld. 59 used in pier and lift span lights for bridges.

FOR MASTHEAD LIGHTS—225 DEGREES

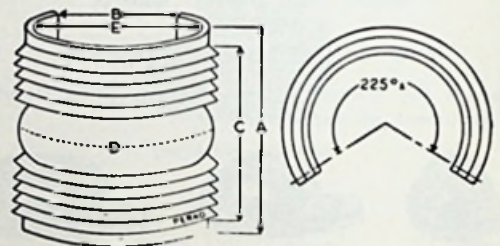

Fig. 256

	A In.	B In.	C In.	D In.	E In.	Clear Each	Colored Each
Int'l	4¼	4	3¾	8¾	3¼	\$4.00	
No. 0	5½	4	5	12¾	4¾	11.50	\$23.60
No. 1	6¾	4	6	12¾	4½	14.80	27.00
No. 2	7½	5¾	6¾	16¾	6½	18.00	34.00
No. 3	8½	6¾	7¾	18¾	7¾	22.50	38.75

Colors are red, green or amber.

Size No. 3 not available in amber.

FOR STERN LIGHTS—135 DEGREES

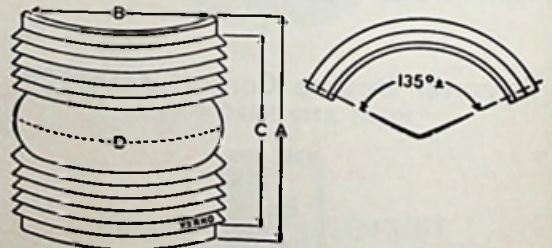

Fig. 269

	A In.	B In.	C In.	D In.	Clear Each	Colored Each
Int'l	4¼	3¾	3¾	4¾	\$3.45	
No. 0	5½	4¾	4¾	7½	9.35	\$13.25
No. 1	6¾	4¾	6¾	7½	10.50	14.25
No. 2	7½	6¾	6¾	10	14.50	23.00
No. 3	8½	7¾	7¾	11¼	17.50	26.00

Colors are red, green, blue or amber.

Size No. 0 not available in blue.

Size No. 3 not available in blue or amber.



## FRESNEL GLOBES

FOR POLE, MAST AND STERN LIGHTS



Fig. 604



Fig. 247



\*Fig. 248-P



Fig. 249



Fig. 250



Fig. 251



\*Fig. 281-P

FIG.	Clear Each	Red Each	Green Each	Blue Each	Amber Each	Outside Diam. Inches	Height Overall Inches	Diam. Opening Inches	Diam. Thread Inches	Weight Ounces Each
604	\$1.25	\$1.85	\$1.85	\$1.85		1½	1¾	7/8	1¼	1¾
247	1.25					1¾	2¾	1½	2	3
248-P	1.00					1¾	2½	1¼	2	1½
249	2.65	3.75	3.75			3	3¾	2¼	2¾	10
250	1.90	2.50	2.50			2½	2¾	1½	2	6
251	1.90	2.50	2.50	2.50	\$2.50	3	3	1½	2	7
281-P	.95					2¾	1¾	1¾		1

Figs. 247 - 248-P - 250 - 251 - for Lights, Figs. 48, 136, 329, 330, 362, 422, 428, 438, 491, 531, 605, 660, 687, 1209, 1233, 1239.

Fig. 249 for Lights Figs. 103, 104.

Fig. 281-P for Figs. 421, 1206, 1276, 1293.

Fig. 604 High Intensity for Lights, Figs. 404, 439, 600, 609, 625, 1145, 1148.

\*These globes are high grade acrylic plastic.

## International GLOBES

FOR INTERNATIONAL LIGHTS PAGES 20 AND 21  
HIGH GRADE ACRYLIC PLASTIC



Fig. 186-P

Each	Height Inches	Inside Diam. Inches	Weight Ounces
\$.95	2¼	1½	¾

Clear - red - green - amber.  
Please specify.

## Dome Light GLASSES

RIBBED DIFFUSING TYPE



Fig. 257

For Dome Lights, Figs. 294, 383 and 555.

Trade Size Inches	Each	Diam. Overall Inches	Depth Inches
3	\$1.30	2¾	2¾
4	1.65	4	¾
5	1.90	5	1¼
6	2.20	6	1½

## Mast Light GLOBES

WITH THREADED BASE



Fig. 77

FIG.	Clear Each	Colored Each
77	\$2.40	\$3.50
106	3.60	4.95

Colors are red, green, blue, amber.



Fig. 106

FIG.	Outside Diam. Inches	Height Overall Inches	Diam. Opening Inches	Diam. Thread Inches	Weight Pounds
77	2¾	5½	1¾	2¾	½
106	3¾	5	2¾	3¾	1¼

Fig. 77 not available in amber.

Fig. 77 for Figs. 488 and 489.

Fig. 106 for Figs. 83, 112, 113, 145, 309, 1163.

FROSTED TYPE

For Dome Lights, Figs. 296, 753.



Fig. 132

Trade Size Inches	Each	Diam. Overall Inches	Depth Inches
3	\$1.30	2¾	¾
4	1.65	4	¾
5	1.90	5	¾
6	2.20	6	¾
8	2.75	7¾	¾

RIBBED OPAL TYPE

For Dome Light Fig. 385.



Fig. 133

Outside Diam. Inches	Each	Extreme Depth Inches
4¾	\$2.75	1¼
5¾	3.00	1¾

NOTE—Spare gaskets for above mast light globes, \$.20 each.

Spare gaskets for above dome glasses and globes, \$.30 each.



## MAZDA LIGHTING BULBS

### Miniature Screw or Bayonet Base



Fig. 337

Bulb No.	Diam. Inches	Bulb No.	Diam. Inches
S-6	3/4	90	3/4
C-7	7/8	94	1
T-7	7/8	351	3/4
S-8	1	1130	1
14	3/4	1142	1
55	3/4	1224	3/4
57	3/4	1226	1
64	3/4	1228	1
68	3/4	1483	3/4
82	3/4	1800	3/4
88	1		



Fig. 340

### Medium Screw Base

Bulb No.	Diam. Inches	Length Overall Inches
T-10	1 1/4	5 3/4
S-14	1 3/4	3 1/4
A-17	2 3/8	3 3/8
A-19	2 3/8	3 1/4
A-21	2 3/8	4 1/4

Volts	Candle Power	No.	Base	Clear Each \$
1.35	.06 amp.	1800	Min. Screw	.40
1.3	.1 amp.	351	Min. Bayonet	.28
2.5	.15 amp.	S-8	D. C.	1.80
2.5	.3 amp.	14	Min. Screw	.25
6	.04 amp.	1483	Min. Screw	.35
6	1 1/2	55	Min. Bayonet	.18
6-8	3	64	D. C.	.18
6-8	6	82	D. C.	.20
6-8	15	88	D. C.	.37
6-8	21	1130	D. C.	.40
12	2	57	Min. Bayonet	.18
12-16	4	68	D. C.	.20
12-16	6	90	D. C.	.20
12-16	15	94	D. C.	.35
12-16	21	1142	D. C.	.40
32	3	1224	D. C.	.60
32	6	1226	D. C.	.70
32	15	1228	D. C.	.90
110	6 watt	S-6	D. C.	.66
120	10 watt	C-7	D. C.	.60
120	15 watt	T-7	Candelabra	.95

Packed, 10 bulbs to a box.

Volts	Watts	No.	Base	Clear Each	Frosted Each
6	15	A-17	Medium	\$1.05	\$.95
6	25	A-19	Medium		.95
6	50	A-21	Medium		1.00
12	15	A-17	Medium	1.10	.95
12	25	A-19	Medium		.95
12	50	A-21	Medium		1.10
32	15	A-17	Medium	1.00	.90
32	25	A-19	Medium		.75
32	50	A-21	Medium		.75
120	25	T-10	Medium	.90	
120	50	A-19	Medium	.75	
120	60	A-19	Medium	.75	
120	100	A-21	Medium	.75	

Packed, 6 bulbs to a package

Please specify, clear or frosted

### Two Filament Bulbs

#### MOGUL BASE FOR THREE WIRE SYSTEM 120 VOLTS

Eliminates the method of using two separate bulbs in two light electric installations. Lamps are always properly focused.

Should one filament burn out it will be indicated on the telltale panel, the other filament can be immediately switched into use.



Fig. 8

Bulb No.	Diam. Inches	Length Overall Inches	Clear Each	
S-11	1 3/8	2 3/8		
6-8	No.	C.P. or Watts	Base	
12-16	S-11	21	Medium	\$ .90
32	S-11	21	Medium	1.30
120	S-11	15	Medium	1.80
	S-11	15	Medium	.60

Packed, 6 bulbs to a box



Fig. 532

Watts	Each	Height Overall Inches	Diam. Inches
50-50	\$7.75	5	3 3/4
100-100	7.50	5	3 3/4

### Mazda Searchlight Bulbs Fig. 24

Volts	Watts	Candle Power	No.	Base	Diameter Inches	Length Overall Inches	Each
6-8		32	RP-11	D. C.	1 3/8	2 3/8	\$.50
6-8		50	RP-11	D. C.	1 3/8	2 3/8	.60
6-8		100	G-16 1/2	D. C.	2 1/4	3	2.20
6-8	108	18 amp.	P-25	Medium	3 1/8	4 3/4	7.75
12-16		32	RP-11	D. C.	1 3/8	2 3/8	.60
12-16		50	RP-11	D. C.	1 3/8	2 3/8	.90
12-16		100	G-16 1/2	D. C.	2 1/4	3	2.20
12-16	216	18 amp.	P-25	Medium	3 1/8	4 3/4	8.50
32		32	RP-11	D. C.	1 3/8	2 3/8	1.40
32		50	RP-11	D. C.	1 3/8	2 3/8	1.90
32		100	G-16 1/2	D. C.	2 1/4	3	2.50
32	2. amp.	150	G-16 1/2	D. C.	2 1/4	3	2.50
32	3.5 amp.		P-25	Medium	3 1/8	4 3/4	8.25
120	256	8 amp.	P-25	Medium	3 1/8	4 3/4	8.25
120	100		G-16 1/2	D. C.	2 1/4	3	4.25
120	250		T-14	Medium	1 3/4	5 3/4	7.75
120	500		T-20	Medium	2 1/2	5 1/2	12.00
120	1000		T-20	Medium	2 1/2	9	10.50
120	1000		T-20	Mogul Screw	2 1/2	5 1/2	12.50





## Hinge BURNERS ALL BRASS



Fig. 242

Used in all cabin lamps, large running lights, bulkhead lamps, etc.

No. 2 Marcy Hinge Burner.  
No. 2A Sun Hinge Burner.

No.	Per Dozen	Diam. Thread Inches	Width Wick Inches
2	\$34.75	1 1/4	7/8
2-A	34.75	1 1/4	7/8

## Lip or Dual CHIMNEYS



Fig. 267

No. 2 For Marcy Hinge Burner.  
2-A For Sun Hinge Burner.

No.	Per Dozen	Height Inches	Diam. Bottom Inches
2	\$16.50	5	2 1/8
2	16.50	6	2 1/8
2-A	16.50	6	2 1/8

Specify height of chimney when ordering.

## Brass BURNERS



Fig. 246

No.	Per Dozen	Diam. Thread Inches	Width Wick Inches
0	\$5.00	7/8	1/2
1	5.60	7/8	3/8

No. 0 used in Class 1 lights.

No. 1 used in Classes 2 and 3 lights.

## Hornet CHIMNEY and BURNER CLEAR CHIMNEY—ALL BRASS BURNER

Used on Cabin Lamp Fig. 141 Size 1 and Fig. 168 Size 0.

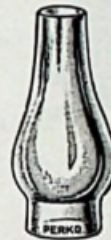

Fig. 230



Fig. 231

Burner used with Flat Wick Fig. 302, No. 0.

Chimneys Per Dozen	Burners Per Dozen	Chimney Size Inches	Burner Thread Inches
\$9.00	\$10.80	4 1/2 x 1 1/2	7/8



Fig. 302

## Flat WICKS

	Per Dozen
Flat Wicks, No. 0, 1/2 inch wide	\$ .84
Flat Wicks, No. 1, 3/8 inch wide	.96
Flat Wicks, No. 2, 1/8 inch wide	1.20

## Long Time BURNER and CHIMNEY BRASS

Used in 10 Day Anchor Lights, Fig. 596

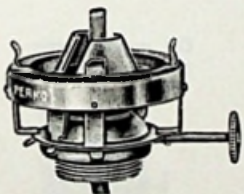

Fig. 245



Fig. 272

Burners Per Dozen	Chimneys Per Dozen	Wicks Per Dozen	Height Chimney Inches	Diameter Chimney Inches
\$30.00	\$21.00	\$2.65	1 3/4	1 1/2

## Eagle CHIMNEYS

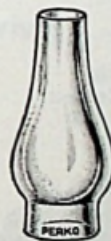

Fig. 94

No.	Per Dozen	Height Inches	Weight Ounces
2	\$12.00	6 1/2	3 1/2
2-A	15.60	8	4

Outside diameter bottom 2 1/8 inches.

No. 2 used on Fig. 1045.

No. 2-A used on Fig. 312.

## Navy Lantern GLOBES



Fig. 262

This globe is standard equipment in Navy lantern, Fig. 49.

Diameter of top 2 1/2 inches  
Diameter of bottom 4 inches  
Height, overall 6 1/2 inches  
Net weight, per dozen 9 pounds

Clear Each	Red Each	Green Each	Blue Each
\$1.85	\$3.20	\$2.25	\$2.25

Colored globes are solid colors, not painted.

## Round GLOBES FOR FIG. 44 GLOBE OR DISTRESS LIGHTS

Supplied in clear, colored or frosted. Colors are Red, Green or Blue.



Fig. 264

Size Inches	Diameter		Height Overall Inches
	Top Inches	Bottom Inches	
6	3 1/8	3 1/8	6 3/8
8	4	4	7 1/2
10	5 1/8	5 1/8	10 1/8

NOTE—6 inch size not available in green.

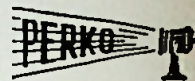

## OIL FOUNTS AND ELECTRIC ADAPTERS

ALL BRASS—FOR LIGHTS CLASS 3 AND SMALLER

Oil



Fig. 582.

Medium Screw  
Electric



Fig. 588

### Delite Type

Fig.	Each	Diameter Inches	Weight Ounces	For Lights Figs.
582	\$2.30	2 $\frac{3}{4}$	4	01-04-05-08-09
588	3.50	2 $\frac{1}{4}$	4	01-04-05-08-09

Price of Fig. 582 does not include holder illustrated.

Holder only, \$1.20 each.

### Spring Type

Oil



Fig. 286

Oil and Electric  
Double Contact

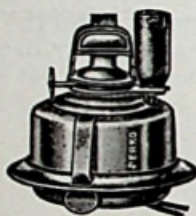

Fig. 736

Electric  
Double Contact

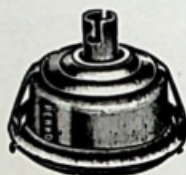

Fig. 291

Electric  
Medium Screw



Fig. 292

Oil and Electric  
Double Contact

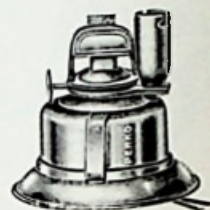

Fig. 733

Fig.	Each	Diameter Overall Inches	Opening In Light Inches	Weight Per Dozen Pounds	For Lights Figs.
286	\$2.30	3 $\frac{5}{8}$	3 $\frac{3}{8}$	2 $\frac{1}{2}$	06-17-18-19-20-49-408 No. 0 and 44, 8 inch size
291	3.50	3 $\frac{5}{8}$	3 $\frac{3}{8}$	3	4-5-06-12-17-18-19-20
292	3.50	3 $\frac{5}{8}$	3 $\frac{3}{8}$	3 $\frac{1}{2}$	06-12-17-18-19-20-49-408 No. 0 and 44, 8 inch size
*733 Oil only	2.30	3 $\frac{1}{2}$	2 $\frac{3}{4}$	2	1
733 Oil and Electric	5.00	3 $\frac{1}{2}$	2 $\frac{3}{4}$	3 $\frac{3}{4}$	1
736	5.00	3 $\frac{1}{2}$	3 $\frac{3}{8}$	4 $\frac{1}{2}$	06-17-18-19-20

\*Supplied without burner or wick.

### Swivel Type

Oil



Fig. 287

Electric  
Double Contact



Fig. 293

Electric  
Medium Screw



Fig. 274

Oil and Electric  
Double Contact



Fig. 735

Fig.	Each	Diameter Overall Inches	Opening In Light Inches	Weight Per Dozen Pounds	For Lights Figs.
274	\$3.50	4 $\frac{1}{2}$	4	4	02-11-69 and 44, 6 inch size
287	2.30	4 $\frac{1}{2}$	4	3	02-69 and 44, 6 inch size
293	3.50	4 $\frac{1}{2}$	4	4	02-11-69 and 44, 6 inch size
735	5.00	4 $\frac{1}{2}$	4	4 $\frac{1}{2}$	02-69

### NOTES

Oil burners and wicks, see Figs. 246 and 302.

D. C. Electric sockets for Figs. 291 and 293, see Fig. 355.

D. C. Electric sockets for Figs. 733, 735 and 736, see Fig. 276.

D. C. Electric sockets and holders for Figs. 733, 735 and 736, see Fig. 458.

Medium screw sockets for Figs. 274, 292 and 588, see Fig. 346, No. 1.



Remote Control SEARCHLIGHTS

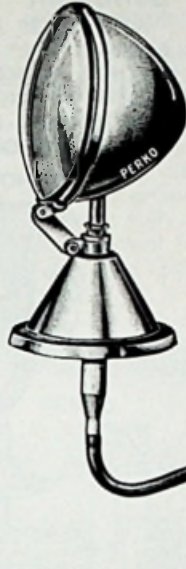

Fig. 241

OPERATION FROM DASH  
BRASS—CHROMIUM PLATED  
SEALED BEAM—6 - 12 - 32 VOLTS

These operate with extreme ease in both the vertical and horizontal range by an effortless twist or pull of the attractive control handle on the dash.

The light may be mounted at any desired location on the deck.

The control casing is galvanized steel with okoseal rubber covering which protects the casing against corrosion and acts as a grease retainer.

No.	WITH 30 INCH CONTROL			WITH 40 INCH CONTROL			WITH 50 INCH CONTROL		
	6 Volt Each	12 Volt Each	32 Volt Each	6 Volt Each	12 Volt Each	32 Volt Each	6 Volt Each	12 Volt Each	32 Volt Each
1	\$44.00	\$44.50		\$47.00	\$47.50		\$50.00	\$50.50	
2	45.50	46.00		48.50	49.00		51.50	52.00	
3	62.00	62.00	\$66.50	65.00	65.00	\$69.50	68.00	68.00	\$72.50

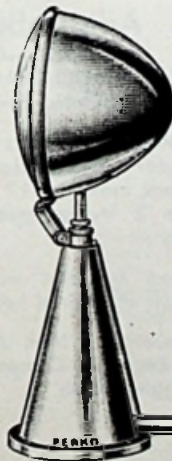

Fig. 283

CABIN ROOF MOUNTING  
FOR OPERATION FROM FLYING BRIDGE  
BRASS—CHROMIUM PLATED  
SEALED BEAM—6-12-32 VOLTS

This new searchlight is designed for mounting forward on cabin roof and for operation from steering position of the flying bridge.

One control handle directs the beam in the horizontal and vertical direction without effort and with positive hold control.

Supplied complete with one rod stanchion, a windshield bearing and a clamp for holding head in fixed position.

Length of control rod, 48 inches

6 Volt Each	12 Volt Each	32 Volt Each	Diam. Lens Inches	Diam. Base Inches	Height Overall Inches	Weight Pounds
\$82.00	\$82.50	\$87.50	7	6	16 1/4	5 1/2

For longer control rod add \$3.00 for each 12 inches or fraction thereof.  
Extra rod stanchions \$2.50 each.



## Combination LIGHT and SEARCHLIGHT

ALL BRASS—CHROMIUM PLATED  
SEALED BEAM SEARCHLIGHT  
6 OR 12 VOLT—30 WATT—RANGE ¼ MILE

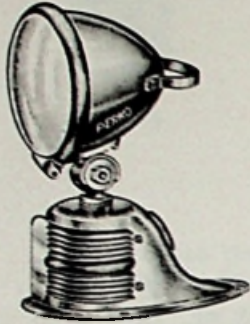

Fig. 416

The searchlight is our 4½ inch diameter sealed beam type. The combination light is our Fig. 1140 with reballing feature. The searchlight has a toggle switch.

6 Volt Each	12 Volt Each	Height Overall Inches	Size Base Inches	Weight Pounds
\$32.00	\$32.50	9	3½x5½	2½

## Hand SEARCHLIGHT

BRASS—CHROMIUM PLATED  
SEALED BEAM—PISTOL GRIP  
PUSH BUTTON SWITCH—3 FT. COILED CORD  
WITH DOUBLE CONTACT OR CIGAR LIGHTER PLUG

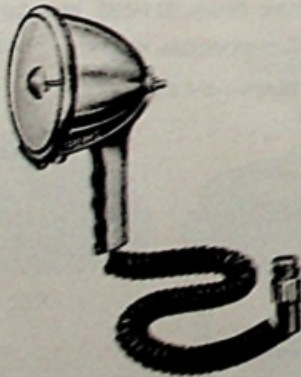

Fig. 440

Has sealed beam searchlight with range about ¼ mile. Supplied with cigar lighter or double contact plug.

Volts	Price	Weight Pounds
6	\$26.95	2
12	\$28.95	2

Supplied with cigar lighter or double contact plug as specified.

## "Sunbeam" SEARCHLIGHTS

WITH GLASS MIRROR REFLECTOR  
6 OR 12 VOLT—50 CANDLEPOWER  
BAYONET DOUBLE CONTACT SOCKET  
ENCASED WIRING—FOCUSING DEVICE  
WATERTIGHT GLANDS AT CABLE  
AND CONTROL ROD ENTRANCES  
PILOT HOUSE CONTROL

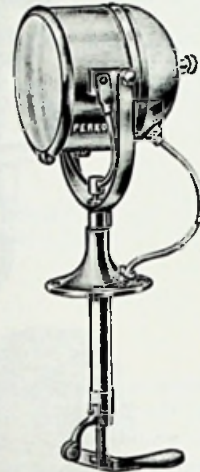

Fig. 306

No.	Polished Brass Each	Chromium Plated Each	Diam. Inches	Diam. Reflector Inches	Height Above Deck Inches	Diam. Base Inches
3	\$105.00	\$120.00	8	7¼	14	5½
4	113.00	128.00	8	7	14	5½

Length control rod below base, 10 inches.  
No. 3 has parabolic mirror reflector, range about ½ mile.  
No. 4 has mangin mirror reflector and 100 C. P. bulb, range about ¾ mile.

## Adjustable SEARCHLIGHT

BRASS—CHROMIUM PLATED  
SEALED BEAM—STREAMLINE BASE  
For Mounting Forward or Aft of Windshield

Adjustable to various heights. From under the searchlight head to the deck, maximum 17 inches, minimum 3 inches, measured vertically.

Knurled nut and washer holds staff at desired height.

Angle of staff from deck is 68 degrees. Complete with toggle switch.

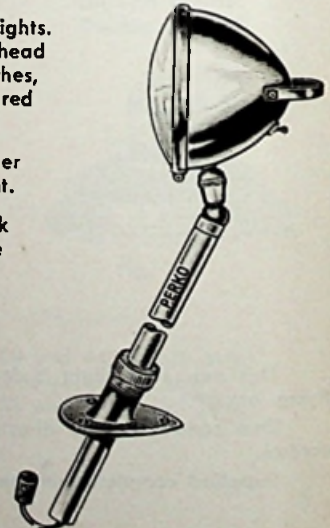

Fig. 240-A

No.	6 Volt Each	12 Volt Each	Diam. Lens Inches	Diam. Base Inches	Weight Pounds
1	\$29.00	\$29.50	4½	3¾x2¼	2½
2	32.00	32.50	6	3¾x2¼	2½



## "Perko" High Power SEARCHLIGHTS

WITH MIRROR REFLECTOR—MEDIUM SCREW SOCKET

VOLTAGE—6, 12, 32, AND 120 VOLTS

PACKING GLANDS AT CABLE AND CONTROL ROD ENTRANCES

**BODIES**—are constructed of heavy wrought brass; stands, yokes, and control mechanism are all cast bronze.

**REFLECTORS**—a glass mirror reflector, which projects a highly concentrated beam of light a great distance.

**FOCUSING DEVICE**—new remote control type, diameter of beam can be changed from inside pilot house.

**PILOT HOUSE CONTROLS**—are of the wheel or lever type, both having their distinct advantages.

**WIRING**—enclosed in flexible metal hose, fully protected from weather.

**BULBS**—Bulbs furnished as standard equipment in various voltages are as follows—6 volts, 18 amps.; 12 volts, 18 amps.; 32 volts, 8 amps.; 120 volts, 500 watt. Can also furnish 120 volts, 250 or 1000 watt bulbs for additional price. See notes below.

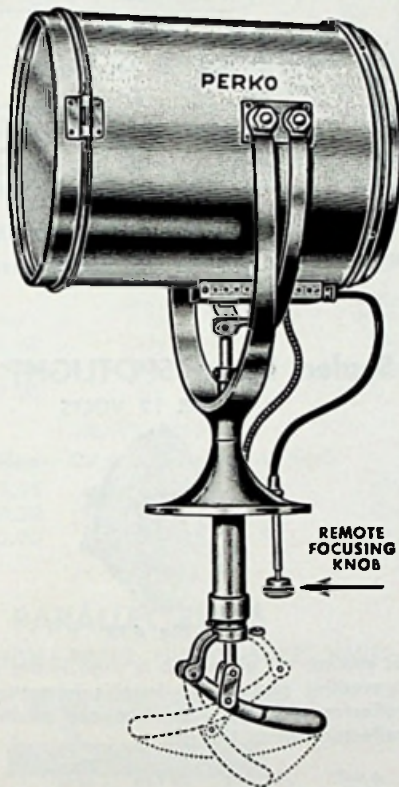

LEVER CONTROL

Fig. 297

Size Inches	Polished Brass Each	Chromium Plated Each
8	\$240.00	\$270.00
10	270.00	300.00
12	325.00	360.00
14	390.00	425.00

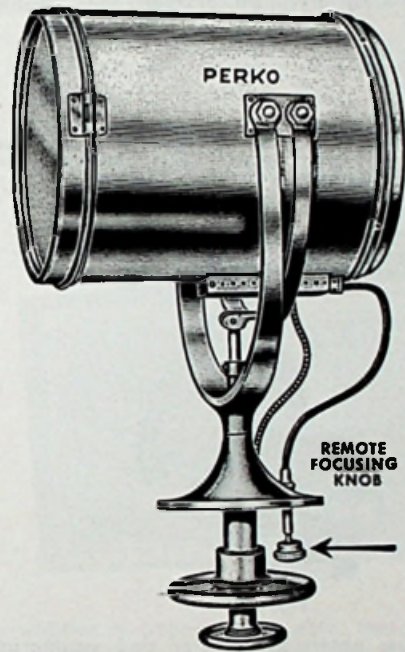

WHEEL CONTROL

Fig. 529

Size Inches	Polished Brass Each	Chromium Plated Each
8	\$265.00	\$295.00
10	295.00	325.00
12	350.00	385.00
14	415.00	450.00

Size Inches	Diameter Reflector Inches	Spare Reflectors Each	Range	Beam Candle Power	Length of Body Inches	Clearance of Glass in Door Inches	Height Above Deck Inches	Diameter of Base Inches	Weight Pounds
8	8	\$20.00	up to ¾ mile	350,000	12¾	7¾	19	6⅞	30
10	10	22.00	up to 1 mile	590,000	14¾	9½	21	6¾	34
12	12	27.50	up to 1½ miles	700,000	17	11¾	24	6¾	41
14	14	37.50	up to 2 miles	850,000	19	13½	26	8½	56

### NOTES

With 120 volt 250 watt bulb, add \$2.00 each.

With 120 volt 1000 watt mogul screw bulb (special construction) in 12 or 14 inch sizes only, add \$40.00 each.

Spare bulbs, lenses, etc. See pages 62 and 70.

Standard length of control below base, Fig. 297 all

sizes, from base to fulcrum of handle, 8 inches. Fig. 529 all sizes from base to center of upper wheel rim, 6½ in.

Special length of pilot house control on Fig. 297 only to order, price on application.

Spare medium screw sockets, \$1.20 each.



## FLOODLIGHTS

WEATHERPROOF — WITH MOGUL SOCKET

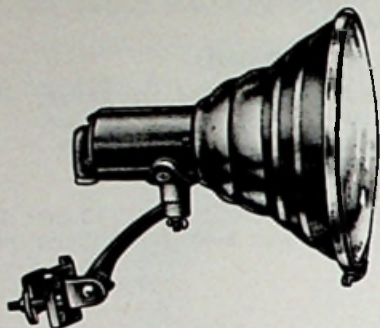

Fig. 227

With polished spun aluminum reflector and heat resisting glass lens. Cast aluminum bracket, spun aluminum housing.

For mounting on wall, cross arm or pipe up to 2½ inches.

Each	Spare Lens Each	Spare Rims Each	Diam. Lens Inches	Length Housing Inches	Maximum Wattage	Weight Pounds
\$26.50	\$7.35	\$4.50	12	14	500	7

## DECK TYPE

with Medium Screw Socket



Fig. 228

With aluminum enameled reflector and weatherproof sealed lens. Gray tone enamel exterior and 6 foot approved cord and plug.

Each	Diam. Lens Inches	Length Housing Inches	Diam. Base Inches	Maximum Wattage	Weight Pounds
\$8.00	7½	8	4¼	100	3

Spare lenses with gasket, each \$4.00.

Spare rim for lens, each \$2.20.

## FRONT LENS FOR SEARCHLIGHTS



Fig. 429

Diam. Inches	Each	For Searchlights Fig. and Size
7¾	\$2.50	305-306
8¾	2.75	297-529—8 inch
10¾	3.15	297-529—10 inch
12¾	4.30	297-529—12 inch
14¾	5.00	297-529—14 inch

## Spreader FLOODLIGHT

ALL BRASS — CHROMIUM PLATED  
SEALED BEAM — 6 OR 12 VOLTS

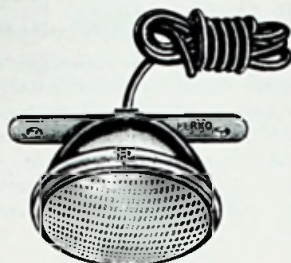

Fig. 268

A fully watertight unit for flood-lighting decks, anchorages, docks or sails.

Each	Diameter: Overall Inches	Depth Inches	Size Mounting Plate Inches	Weight Pounds
\$11.85	4¾	4¼	6 x 1	1¼

Spare Sealed Beam Unit Each \$2.75

Specify voltage, 6 volt supplied unless otherwise specified.

## Sealed Beam SPOTLIGHT UNITS

6 OR 12 VOLTS

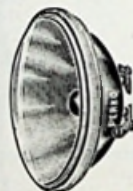

Fig. 433

This sealed, all glass unit is used in the searchlights on the preceding pages. The lens is hermetically sealed to the reflector. Dirt and moisture are positively excluded. The reflector cannot tarnish.

No	6 Volt Each	12 Volt Each	32 Volt Each	Diam. Lens Inches	Watts	Range About
1	\$3.00	\$3.75		4¼	30	¼ mile
2	3.00	3.75		6	30	½ mile
3	6.50	6.50		7	100	½ mile
3			\$10.75	7	200	¾ mile

## Electric COMPASS LIGHT

BRASS—CHROMIUM PLATED

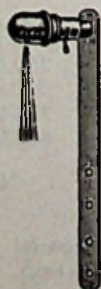

Fig. 707

To be mounted on compass box for illuminating compass at night. A shield is furnished over the bulb to eliminate glare. Shield has small hole sufficient to illuminate proper portion of compass card.

Chromium Plated Each	Height Overall Inches	Weight Ounces
\$4.50	8	5

NOTE — Shield will accommodate a G-6 bayonet D.C. bulb 6, 12 or 32 volt.



**Lucite PARALLEL RULES**  
 TRANSPARENT  
 WITH BRASS, CHROMIUM PLATED BARS

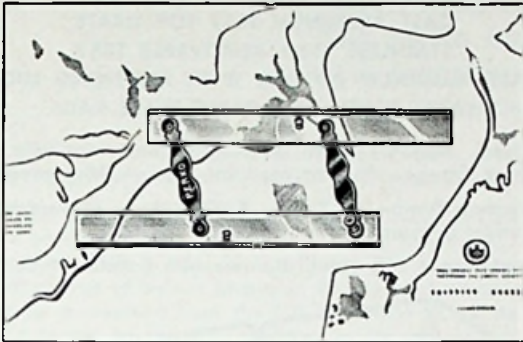

Fig. 630

A new transparent rule of clear lucite through which the chart data can be easily seen.

**STANDARD TYPE**  
 With Finger Grips

Length Closed Inches	Each	Width Closed Inches	Thickness Inches	Weight Ounces
12	\$5.60	2½	¼	3½
15	6.25	2¾	⅜	5½
18	7.00	3¼	½	7

**HEAVY TYPE**

With Finger Grips and Tightening Knob

12	\$ 8.25	2½	⅝	6½
15	10.20	2½	¾	7½
18	12.20	2½	¾	8½

**PARALLEL RULES**

EBONY FINISH—BRASS, NICKEL PLATED PARTS



Fig. 686

Length Closed Inches	Each	Width Closed Inches	Weight Ounces
12	\$5.00	2½	6
15	5.50	2½	6½
18	6.25	2½	7

**DIVIDERS**

BRASS—NICKEL PLATED—NAVY TYPE

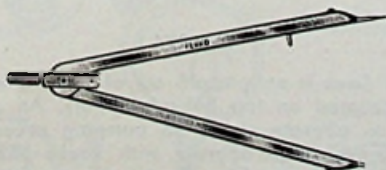

Fig. 693

No. 1	Length, 5½ inches, each	\$1.25
No. 2	Length, 7 inches, each	3.95

No. 2 size has straightening device and reversible points.

**Improved COURSE PROTRACTOR**  
 INDICATES COURSE AND REVERSE COURSE  
 TRANSPARENT

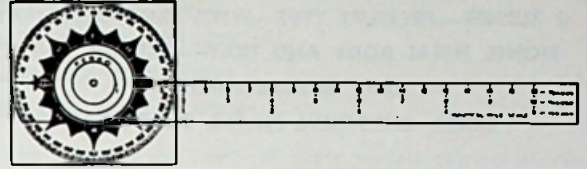

Fig. 706

Arm has various mileage scales used on all coastal and harbor charts.

Arm extended on short end to show reverse course.

A precision instrument, accurate in detail. Positions, depths, etc., are clearly visible when covered by protractor.

Each	Extreme Length Inches	Diam. Compass Card Inches
\$3.25	21½	6¾

**Yacht LOG BOOKS**

100 PAGES



Fig. 708

In addition to pages for log data, these books contain useful information such as extracts from Bowditch Practical Navigator on symbols for weather, state of sea, cloud formations, force of wind, guest log and marine telephone log.

No. 1 Binding: Imitation leather, pebble finish, starboard green color, gold letters, without gold border. Each ..... \$4.50

No. 2 Binding: Imitation leather, pebble finish, pilot blue color, gold letters and border. Each ..... \$4.60

**CHART CASES**



Fig. 372

Made of galvanized iron or sheet copper, water-tight cover, folding handle on side for carrying.

Diam. Inches	Length Inches	Galv. Each	Polished Copper Each
3	36	\$ 9.00	\$18.00
4	36	11.00	21.50



**"PERKO"  
MONEL ALCOHOL STOVE**

2 BURNER—PRESSURE TYPE—WITH REMOVABLE TRAY  
MONEL METAL BODY AND TRAY—NATURAL FINISH  
CAST BRONZE BURNERS  
BRASS, CHROMIUM PLATED GUARD RAIL

**CONSTRUCTION** — of heavy gauge monel metal. Satin finish.

**BURNERS** — Cast bronze with slotted manifold producing intense heat.

**TRAY** — An integral part of front apron, readily removable for cleaning but will not rattle. It insulates the fuel tank from heat. Sheet asbestos is affixed to its bottom. Tray cannot slide out when boat is heeled.

**GUARD RAIL** — Brass, chromium plated. Front section is removable to accommodate large pots and pans.

**AIR PRESSURE GAUGE** — Accurate and easy to read; it shows best working pressure.

**PRESSURE PUMP** — All brass, knob locks into pump, cannot back out under back pressure.

**FILLER CAP AND AIR ESCAPE VALVE** — Inside of front apron, but readily accessible.

**FUEL TANK** — 1½ gallon capacity, rectangular shape and hidden by front apron, fully insulated from heat of burners.

**FUEL CONSUMPTION** — Using a good grade of "Burning Alcohol," both burners will operate continuously for 14 hours on one gallon of fuel and one pound of air pressure.

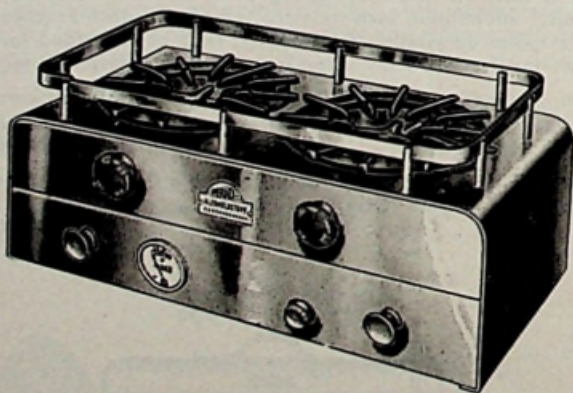

Fig. 364

Complete Each	Extreme Length Inches	Extreme Width Inches	Extreme Height Inches	Weight Pounds
\$99.50	20½	12	8½	27

Above price includes a Fig. 365 funnel for filling.

**"PERKO" IMPROVED  
STAINLESS STEEL ALCOHOL STOVE**

SATIN FINISH STAINLESS STEEL BODY  
CAST ALUMINUM FLAT TOP GRATE  
STAINLESS STEEL REMOVABLE TRAY  
CAST ALUMINUM BOTTOM WITH FASTENING LUGS  
SATIN FINISH REMOVABLE BRASS RAILS

Round, Stainless Steel Tank—1¾ quarts capacity. Air Pressure Gauge—Easy to read for best working pressure.

Pressure Pump—All Brass—Knob locks to prevent back-out under pressure.

Cast Bronze "Hy Heat" Burners with Bakelite Knobs.

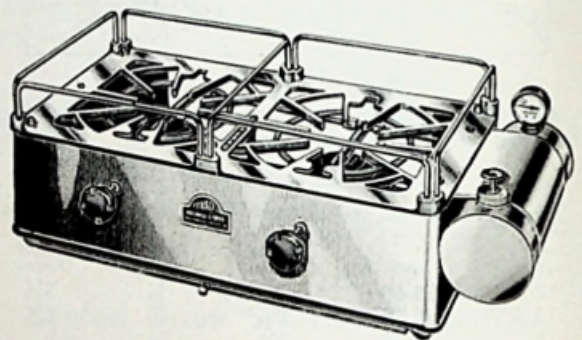

Fig. 334

Each	Extreme Length Inches	Extreme Width Inches	Extreme Height Inches	Weight Pounds
\$93.00	25½	13	8¼	20

**"Galley Slave"  
GRAVITY ALCOHOL STOVE**

WHITE VITREOUS ENAMELED BODY—BRASS GUARD RAILS  
BRASS BURNERS—BRASS FUEL TANK

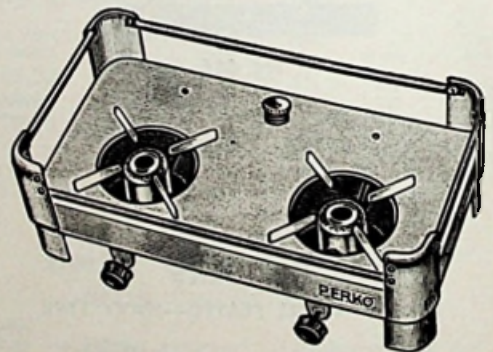

Fig. 376

The Fuel Tank is underneath out of sight, filled through filler cap located on top behind burners. An economical and easy to operate stove, no pumping necessary. Just preheat burners then operate with knobs like stove at home. Has an intense blue flame with remarkable heating ability.

Each	Length Overall Inches	Width Overall Inches	Height Overall Inches	Weight Pounds
\$26.25	19½	11	6¼	6½





## "PERKO" MONEL BOTTLED GAS STOVE

FOR USE WITH PROPANE OR BUTANE L. P. GAS

2 BURNER — WITH REMOVABLE TRAY

MONEL METAL BODY AND TRAY — SATIN FINISH

COLD FORGED ALUMINUM CENTER SIMMER BURNERS

BRASS, CHROMIUM PLATED GUARD RAIL AND POSTS

BLACK PLASTIC CONTROL KNOBS AND TRAY HANDLE

The last word in convenience, practicability and good looks with many of the faults of older models eliminated. No enamel to chip, crack or discolor. Monel metal is rich looking, easily cleaned and is non-corrosive.

**THE BURNER** is especially unique, in fact it's two burners in one. The outer rim is a high speed cooking burner for quick broiling, frying, etc. There is also a tiny, inner, economical simmer burner which maintains the cooking while using only a fraction of the gas usually consumed with ordinary single burners and it can be used independently of the starting burner; no other type of burner possesses this decided advantage. The center simmer burner provides exactly the right heat for every cooking requirement from the full fire power of the starting burner to the mere beads of flame of the "keep-warm" position of the center simmer. All controlled by the one control knob.

**EASY CLEANING** — The burner cap can be removed in less than one second.

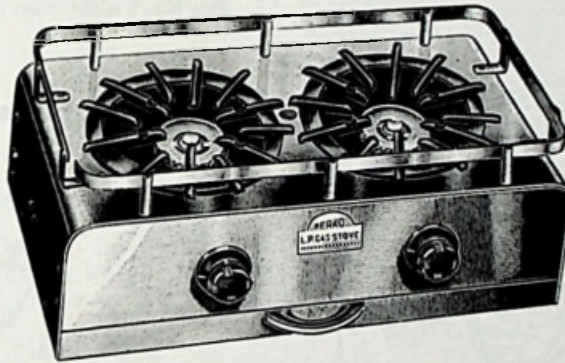

Fig. 373

Complete Each	Extreme Length Inches	Extreme Width Inches	Extreme Height Inches	Weight Pounds
\$86.00	20¾	12	8½	25

## BOTTLED GAS STOVE EQUIPMENT

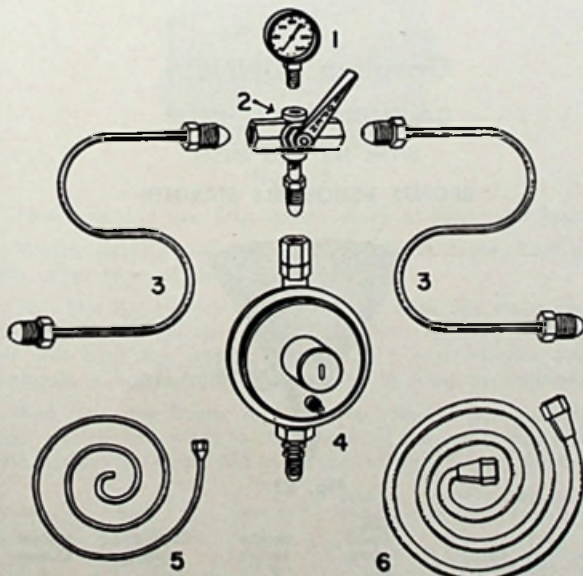

Fig. 374

No.	Description	Each
1	Polished Brass Pressure Gauge	\$ 4.60
2	Forged Bronze Two Way Valve Manifold with Indicating Handle	16.00
3	Pigtails (Tank Connections)	2.80
4	Pressure Regulator with Relief Valve and Mounting Brackets	11.50
5	¼ inch Copper 10 Foot Vent Line with One Fitting	4.50
6	½ inch Copper 20 Foot Fuel Supply Line with Two Fittings	13.50
7	Plugs for Manifold	2.60

Note — The above Manifold item No. 2 and Regulator item No. 4 is listed by the Underwriters Laboratories.



## "Perko" ALCOHOL BURNER

CAST BRONZE



	Each
Fig. 367 Burner for Stoves Figs. 334, 364 .....	\$19.00
Wire Brush Filters Only .....	2.40
Priming Pan Only .....	1.50
Packing Nut for Valve Stem .....	.45
Grates only for Stove .....	2.40

## POT HOLDERS

ALL BRASS—CHROMIUM PLATED



Fig. 369

Made for attachment to our alcohol stoves Figs. 334 and 364. Adjustable on the stove for various sizes of pots, pans, etc.

No.	Per Pair	Length Centers of Rail Inches	Weight Per Pair Ounces
1	\$4.50	9 3/8	7 1/2
2	4.50	10 1/2	8

Size No. 1 is for older models of Fig. 364 stove.

## Alcohol Stove Parts

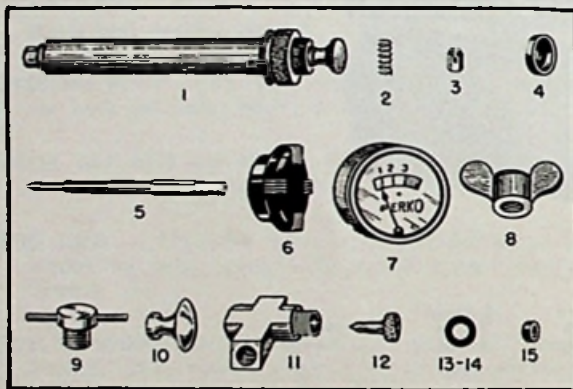

Fig. 368

No.		Each
1	Fuel Tank Air Pump complete .....	\$3.75
2	Pump Check Valve Spring .....	.40
3	Pump Check Valve .....	.60
4	Leather Plunger for Pump .....	.40
5	Needle Valve Stem .....	.85
6	Plastic Control Knob .....	1.00
7	Air Pressure Gauge .....	3.00
8	Wing Nut for Filter Entrance .....	.85
9	Filler Cap for Fuel Tank .....	1.25
10	Knob for Removable Tray .....	.85
11	Fitting for Fuel Supply Line .....	1.20
12	Screw for Air Escape Valve .....	.40
13	Lead Gasket for Wing Nut No. 8 .....	.30
14	Lead Gasket for Filler Cap No. 9 .....	.30
15	Graphite Packing for Valve Stem .....	.12

## Offset FUNNEL

HEAVY GAUGE ZINC  
BRASS STRAINER



Fig. 365

Designed primarily for filling our stoves, this funnel is a handy one for various purposes on a boat, at home or in a garage.

Each	Capacity Ounces	Diam. Mouth Inches	Diam. Spout Inches	Weight Ounces
\$3.00	3	3	3/8	2

## Gasoline FUNNELS

GALVANIZED SHEET METAL  
WITH No. 100 MESH  
BRONZE REMOVABLE STRAINER



Fig. 81

No.	Each	Diam. Top Inches	Height Inches	Capacity Pints	Weight Ounces
1	\$2.70	6 3/8	7	1	6
2	3.15	8	8 1/2	2	8



## Marine EXHAUST BLOWERS CAST ALUMINUM HOUSING

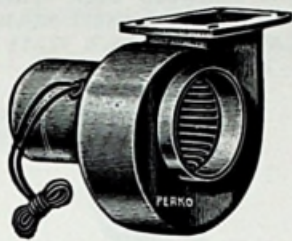

Fig. 778

For removing dangerous gasoline fumes from the bilge and engine room, exhausting excess heat and cooking odors from the galley. Getting rid of foul air or odors from cargo holds and bilges.

An absolute necessity to the motor boat because their use decreases the hazard of fires and explosions from gasoline fumes.

No.	Size Intake Inches	Size Outlet Inches	Dimensions Overall Inches	Capacity Cubic Feet Per Minute	Size Flange Inches
1	3	2½	7½x6x6	90	3½x3½
2	4	4	8½x8x8	186	4½x4½

Volts	No. 1 Each	No. 2 Each	Amperes	Horsepower
6	\$23.25	\$34.00	8.0	1/40
12	23.25	34.00	4.0	1/40

A caution plate is furnished with every Blower.

## Hot Air CABIN HEATER CAST ALUMINUM 6 OR 12 VOLTS

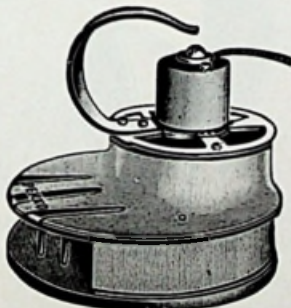

Fig. 595

Now you can use your galley stove to heat your boat.

Works equally well on gas, alcohol, kerosene, coal or any other type of stove.

This Hot Air Heater takes the heat from the stove and distributes it to all corners of the cabin. This blast of hot air will heat the average cabin in a few minutes and maintain a comfortable temperature as long as required.

Just place the heater on the stove over the burner, connect electric fan wires to battery, light the stove and in a few minutes the cabin will be as comfortable as you want it.

Volts	Each	Amperes	Diam. Inches	Height Inches	Weight Pounds
6	\$24.95	1.5	8½	7	9½
12	24.95	.75	8½	7¼	9¾

Specify Voltage When Ordering

## EXHAUST BLOWERS For Bilge Installation

FULLY ENCLOSED SPARKPROOF MOTOR  
CAST ALUMINUM HOUSING

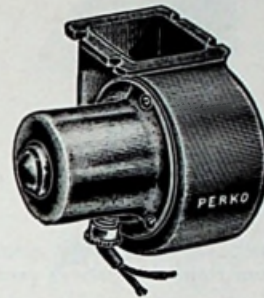

Fig. 791

A blower that may be installed in the bilge without fear of sparks igniting gasoline fumes.

Motor enclosed in brass cover. Shaft passes through a Neoprene seal and electric cable enters cover through a watertight packing gland.

No.	Size Intake Inches	Size Outlet Inches	Dimensions Overall Inches	Capacity Cubic Feet Per Minute	Flange Inches
1	3	2½	7½x6x6	90	3½x3½
2	4	4	8½x8x8	186	4½x4½

Volts	No. 1 Each	No. 2 Each	Amperes	Horsepower
6	\$32.50	\$44.00	8.0	1/40
12	32.50	44.00	4.0	1/40

A caution plate is furnished with every Blower.

## Improved Blower and Ignition SWITCHES

CAST BRONZE—FLUSH TYPE



Watertite Enclosed Switch  
Fig. 149



Non-Watertite Switch  
Fig. 155

With these improved switches the engine cannot be started before the blower has been turned on, then before the engine can be stopped the blower must again be started thus clearing out any remaining fumes before and after engine operations.

Fig.	Polished Bronze Each	Chromium Plated Each	Diam. Face Plate Inches	Diam. Box Inches	Depth Inches	Weight Pounds
149	\$17.00	\$17.50	4¼	3¼	1¾	1¾
155	16.00	16.50	3¾	...	1¾	1¾



## Turbine VENTILATORS FOR MARINE USE IMPROVED BEARING RUNNING IN OIL GALVANIZED STEEL OR COPPER

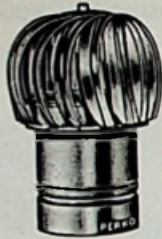

Fig. 744

For removing gasoline fumes from engine room and bilge, cooking odors from the galley, ventilation of the cabins, etc.

The moving breeze whirls the head and the resulting vacuum causes a powerful upward lift to the air below. Absolutely quiet in operation, durable and rainproof.

Inside Diam. Inches	Galv. Steel Each	Copper Each	Height Overall Inches	Diam. Overall Inches	Capacity C.F.M.	Galv. Weight Pounds
4	\$13.50	\$22.50	10	7	140	2¾
5	13.75	22.75	12	8½	152	3½
6	14.25	23.25	13	9½	196	4½
7	16.50	27.75	15	11	243	6
8	17.75	29.50	16	12½	285	7
10	21.50	36.25	18½	15	445	10
12	24.50	40.00	20	17½	650	12

With reinforcing band around bottom of neck supplied to order, price on application.

Galvanized vents are painted aluminum.

## WATER DECK IRONS GALVANIZED CAST IRON



Fig. 430

Size of Stove Pipe Inches	Each	Outside Diam. of Neck Inches	Diam. Flange Inches	Weight Pounds
2	\$ 4.50	2¼	5½	1¼
2½	5.25	2¾	6½	2
3	6.25	3¼	7½	4
3½	7.25	3¾	8½	5
4	7.80	4¼	9¼	6¾
4½	9.75	4¾	10	8
5	10.50	5¼	10½	9
5½	12.50	5¾	11	9¾
6	12.75	6½	11¼	11¼

### VENTILATOR NOTES

Spare Deck Plates for above Cowl Ventilators, see Figs. 419 and 527.

When ordering cowl ventilators only, without deck plate, please specify whether with or without ring on neck.

All above cowl ventilator sizes are standard; special sizes and heights made to order.

## Cowl VENTILATORS ROUND MOUTH WITH THREADED DECK PLATE SHEET STEEL OR SHEET BRASS CAST BRONZE DECK PLATE

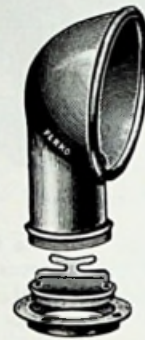

Fig. 510

Steel ventilators are hot galvanized after fabrication.

Deck Plate Size Inches	Galv. Each	Polished Brass Each	Chromium Plated Each	Diam. Mouth Inches	Height Overall Inches	Weight Pounds
2	\$ 19.00	\$ 27.50	\$ 35.00	4	5½	1¼
2½	20.50	29.75	37.00	5	6½	1¾
3	22.50	32.50	40.00	6	8	2½
4	27.00	37.00	44.00	8	11	4
5	46.00	56.00	66.00	10	13	6
6	62.00	72.00	82.00	12	16	9
8	115.00	143.00	166.00	16	21	15½

## Cowl VENTILATORS WITH SWIVEL DECK PLATE SHEET STEEL OR SHEET BRASS CAST BRONZE DECK PLATE

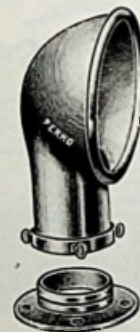

Fig. 513

Deck Plate Size Inches	Galv. Each	Polished Brass Each	Chromium Plated Each	Diam. Mouth Inches	Height Overall Inches	Weight Pounds
3	\$ 25.75	\$ 35.00	\$ 43.00	6	8	2
4	32.50	42.00	50.00	8	12	3¾
5	49.00	60.00	70.00	10	13½	4¾
6	65.00	75.00	86.00	12	17½	7½
8	96.00	123.00	145.00	16	20½	11½
10	167.00			20	28	30

Note—10 inch size is heavy 18 gauge steel and price applies to cowl only with galvanized band on neck. No deck plate.

Cover for Fig. 513 deck plate for use when ventilator is removed, price on application.

Polished copper vents supplied to order, price on application.



## Streamline Space Saver VENTILATOR

CAST BRONZE—CHROMIUM PLATED



Starboard Side  
Fig. 771

For mounting on catwalk against outside of deck house or bulkhead where space is limited.

Bosses for fastening are inside ventilator out of sight but angled toward mouth for insertion of wood screws. Drilled for No. 8 F.H. wood screw.

Supplied in pairs for starboard and port sides. When ordering a half pair mention side required.

Chromium Plated Per Pair	Length Overall Inches	Height Overall Inches	Dimensions Mouth Inches	Weight Per Pair Pounds
\$14.50	9 $\frac{3}{4}$	4 $\frac{1}{2}$	4x1 $\frac{3}{4}$	2 $\frac{3}{4}$

## Space Saver VENTILATORS

CAST BRONZE—CHROMIUM PLATED

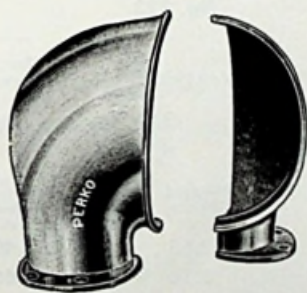

Starboard Side      Port Side

Fig. 782

Designed especially for mounting against outside of deck house or cabin, takes up very little space, can be used to advantage in connection with exhaust fan Fig. 778.

No.	Inside Diameter at Base Inches	Measurements Inside at Mouth Inches	Height Overall Inches	For Screw No.	Weight Per Pair Pounds
1	2 $\frac{1}{2}$	2 $\frac{3}{8}$ x5	6 $\frac{3}{4}$	8	3 $\frac{3}{4}$
2	3 $\frac{1}{2}$	3 $\frac{1}{8}$ x7 $\frac{1}{2}$	9	8	6

No.	Chromium Plated Per Pair
1	\$19.95
2	24.50

When ordering a half pair, please mention whether for port or starboard side.

## New Half VENTILATORS

CAST BRONZE—CHROMIUM PLATED

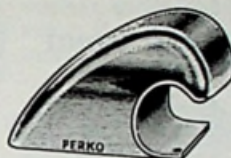
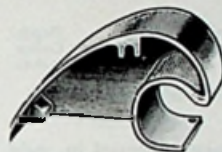

Fig. 936



Back View

A practical but attractive ventilator for mounting against side of deck house. Has high splash guard and mosquito screen.

Each	Extreme Height Inches	Dimensions Base Inches	Weight Pounds
\$10.00	3 $\frac{1}{4}$	5x2 $\frac{1}{4}$	1 $\frac{1}{4}$

## Cruiser VENTILATOR

STREAMLINE—CAST BRONZE



Fig. 908

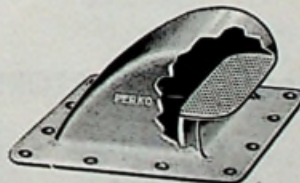

Cut away view showing screen and water guard

An extremely neat ventilator for cruiser decks and cabin roofs.

An integral water guard inside mouth prevents spray or rain from entering ventilator. A bronze screen permanently installed to keep insects out of cabin.

Brushed Bronze Each	Polished Bronze Each	Chromium Plated Each	Size Base Inches	Height Overall Inches	For Screw No.	Weight Pounds
\$14.50	\$22.50	\$24.00	7x7	3 $\frac{1}{2}$	8	4 $\frac{3}{4}$



## Junior Transom VENTILATOR

CAST BRONZE



Fig. 1069

Burnished Bronze Each	Chromium Plated Each	Size Flange Inches	Depth Collar Inches	For Screw No.	Weight Pounds
\$2.40	\$4.20	6 $\frac{3}{4}$ x2 $\frac{1}{4}$	$\frac{3}{4}$	6	$\frac{3}{4}$

With bronze screen soldered in, add \$.90 each.

## "Midget" VENTILATORS

CAST BRONZE



Fig. 321

Popular for shielding gas tank vent outlets.

No.	Burnished Each	Chromium Plated Each	Dimensions Base Inches	Height Opening Inches	For Screw No.	Weight Ounces
1	\$.40	\$1.25	1 $\frac{1}{2}$ x1 $\frac{1}{2}$	$\frac{3}{8}$	4	1 $\frac{1}{2}$
2	.50	1.50	2 x2	$\frac{1}{2}$	6	2 $\frac{1}{4}$

## SENIOR Transom VENTILATOR

CAST BRONZE



Fig. 1062

Plain Bronze Each	Chromium Plated Each	Dimensions Inches	For Screw No.	Weight Pounds
\$3.45	\$5.80	10x4	8	1

## Clam Shell VENTILATORS

CAST BRONZE



Fig. 323

No.	Width Opening Inches	Height Opening Inches	Size Base Inches	For Screw No.	Weight Ounces
4	2 $\frac{3}{4}$	1 $\frac{1}{2}$	3 $\frac{3}{4}$ x3 $\frac{1}{2}$	7	7
5	3 $\frac{1}{2}$	2	4 x3 $\frac{3}{4}$	7	14

No.	Polished Bronze Each	Chromium Plated Each
4	\$2.65	\$3.40
5	3.10	3.85

## Locker VENTILATORS

CAST BRONZE

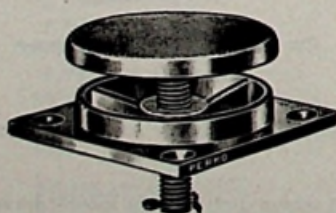

Fig. 783

Polished Bronze Each	Chromium Plated Each	Diam. of Opening Inches	Size Plate Inches	Weight Pounds
\$7.20	\$9.25	1 $\frac{1}{2}$	2 $\frac{1}{2}$ x2 $\frac{1}{2}$	$\frac{1}{2}$

## Streamline VENTILATORS

CAST BRONZE



Fig. 324

No.	Width Opening Inches	Height Opening Inches	Size Base Inches	For Screw No.	Weight Ounces
2	1 $\frac{3}{4}$	1	2 $\frac{5}{8}$ x3 $\frac{3}{8}$	7	6
3	2 $\frac{3}{8}$	1 $\frac{5}{8}$	3 $\frac{3}{8}$ x4 $\frac{3}{8}$	7	12

No.	Polished Bronze Each	Chromium Plated Each
2	\$2.65	\$3.40
3	3.10	3.85



## Ventilator DECK PLATES

CAST BRONZE—SCREW TYPE



Fig. 527

Complete with key and extra ring for cowl.

Diameter Opening Inches	Machine Finish Each	Polished Bronze Each	Chromium Plated Each	Diameter Plate Inches	Weight Pounds
2	\$ 7.85	\$ 9.25	\$11.25	3 $\frac{3}{4}$	$\frac{3}{4}$
2 $\frac{1}{2}$	8.90	10.00	12.00	4 $\frac{1}{2}$	1 $\frac{1}{4}$
3	10.00	11.80	13.90	4 $\frac{3}{4}$	1 $\frac{3}{8}$
3 $\frac{1}{2}$	13.25	14.95	17.85	5 $\frac{1}{2}$	2
4	14.95	17.85	20.20	5 $\frac{3}{4}$	2 $\frac{1}{2}$
5	21.00	24.25	27.00	7 $\frac{1}{16}$	3 $\frac{1}{2}$
6	26.50	30.25	33.00	8 $\frac{1}{4}$	6 $\frac{1}{4}$
8	57.00	62.50	68.00	10 $\frac{1}{4}$	8 $\frac{1}{2}$

## Swivel DECK PLATES

CAST BRONZE—FOR COWL VENTILATORS

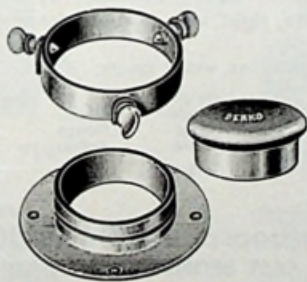

Fig. 419

For Size Ventilator Inches	Opening in Base Inches	Machine Finish Each
3	2 $\frac{1}{4}$	\$12.50
4	3 $\frac{1}{2}$	18.75
5	4 $\frac{1}{2}$	23.00
6	5	27.50
8	7	36.25

Permits cowl to be turned to any direction.

Price does not include cap, if cap is desired add 25% to above prices.

## Pump VALVES



Fig. 237

Galvanized iron with oak leather clapper, galvanized iron weight on both sides of leather riveted together and screwed to casting.

Diameter inches	2	2 $\frac{1}{2}$	3	4
Wgt. per doz lbs.	4	6	7	11
Per doz.	\$10.80	\$16.00	\$15.00	\$19.00

## Leather PLUNGERS

OAK LEATHER

Riveted together, strong and durable.



Fig. 239

For Diam. Pump Inches	Per Dozen	Weight Per Dozen Pounds
2	\$7.20	$\frac{3}{4}$
2 $\frac{1}{2}$	7.25	1 $\frac{1}{4}$
3	9.24	1 $\frac{1}{2}$
4	9.50	1 $\frac{3}{4}$

## Parts for Brass Bilge Pumps

Flange and cup washers are leather, especially treated for use in salt water. Split washer is wrought brass. Ball is hollow and made of wrought brass.

No. 1 for numbers 1 and 5 bilge pumps.

No. 2 for numbers 2, 4, 6 and 8 bilge pumps.



		Outside Diam. Inches	Each
Flange Washer Fig. 203	No. 1	1 $\frac{1}{8}$	\$ .40
	No. 2	1 $\frac{3}{8}$	.45
Cup Washer Fig. 204	No. 1	1 $\frac{1}{8}$	\$ .40
	No. 2	1 $\frac{3}{8}$	.45
Split Washer Fig. 205	No. 1	1 $\frac{1}{8}$	\$ .11
	No. 2	1 $\frac{3}{8}$	.17
Hollow Ball Fig. 206	No. 1	$\frac{1}{2}$	\$ .35
	No. 2	$\frac{3}{8}$	.40
Valve Fitting For Plunger Fig. 456	No. 1		\$1.25
	No. 2		1.35
Packing Nut Fig. 457	No. 1		1.35
	No. 2		1.75

NOTE—The above parts are also used in Fig. 345 bilge pumps, and Fig. 146 crank case pump.

## Rubber Hose and Strainer

FOR FIGS. 200, 202 and 723 BRASS BILGE PUMPS

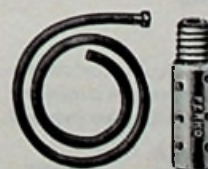

Fig. 208 Fig. 209

Heavy moulded rubber hose, durable and lasting.  $\frac{3}{8}$  inch inside diameter.

Standard 5 ft. length  
Cast Bronze Strainer

Other lengths of hose can be furnished. Price on application.

Each  
\$1.20  
.90

**Automatic BOAT BAILERS**

BRASS TUBING—CAST BRONZE FITTINGS  
 WITH POLYETHYLENE BALL CHECK  
 FOR RUNABOUTS

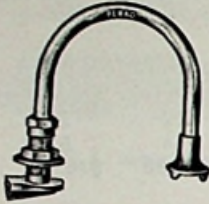

Fig. 410

Has outlet fitting in streamline design to reduce resistance, screened inlet fitting.

Operates at speed of about 7 miles per hour.

Requires no further attention after installation.

Each	Height Inside Hull Inches	Diam. Tubing Inches	For Hull Thickness Inches	Weight Pounds
\$11.00	7	3/4	up to 1 3/4	1 3/4

Spare polyethylene balls, per dozen . . . . . \$1.50

**Automatic BOAT DRAINERS**

CAST BRONZE—BURNISHED

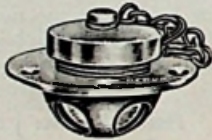

Fig. 213

For use in life boats. Made of heavy cast bronze, with sponge rubber ball valve. Cast bronze cover with chain attached, threaded 1 1/8 inches, No. 14 thread.

Complete Each	Caps Only With Chain Each	Balls Only Per Dozen	Diam. Opening Inches	Diam. Flange Inches	Diam. Ball Inches
\$6.25	\$1.95	\$3.00	1 1/4	3 3/4	1 1/2

**Transom DRAIN PLUGS**

FOR OUTBOARD BOATS  
 PLAIN BRASS

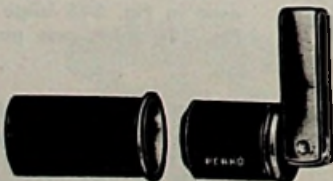

Fig. 414

To release plug, raise handle to position illustrated. Remove plug while boat is in motion and water will drain out. Install in lowest part of transom. Watertight when closed.

Each	Diam. Tube Inches	Length Overall Inches	Length Tube Inches	Weight Ounces
\$2.20	1	2 1/2	2	4 1/2

**Small BOAT DRAINER**

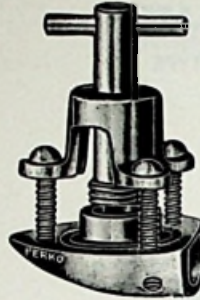

Fig. 386

THREADED TYPE  
 CAST BRONZE—BURNISHED

Each	Height Inside Boat Inches	Width Overall Inches	Weight Pounds
\$5.50	2 3/4	2 1/2	1 1/4

Starts draining at speed of 5 miles per hour. Install in after end of boat and be sure that mouth is toward the stern.

Made for hulls 3/8 inch or thicker but may be used with thinner hulls by cutting away necessary portion of neck. Depth of mouth below hull is 3/4 inch.

**Small BOAT DRAINER**

SPRING TYPE—STAINLESS STEEL SPRING  
 CAST BRONZE

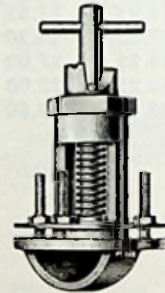

Fig. 387

Install in after end of boat with mouth toward stern. Starts draining at about 5 miles per hour.

To open lift "T" handle and lock by half turn to left. A slight turn to right will release strong spring closing drainer tightly.

For use in metal or wood boats.

Bronze Each	Height Inside Boat Inches	Diam. Flange Inches	Weight Pounds
\$7.25	4	2 3/4	1

**Garboard DRAIN PLUGS**

CAST BRONZE—BURNISHED

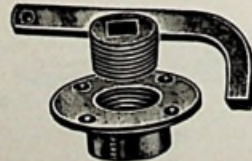

Fig. 124

A few of these drain plugs installed in garboard allows quick drainage of boat when hauled out, by removing heavy plug. Threads are tapered pipe sizes and plugs are watertight.

Burnished Bronze Each	Pipe Size Inches	Diam. Flange Inches	Depth Inches	Weight Ounces
\$4.95	1	3 3/4	1	10

Furnished complete with galvanized wrench.





**Garboard DRAIN PLUGS**

CAST BRONZE—BURNISHED

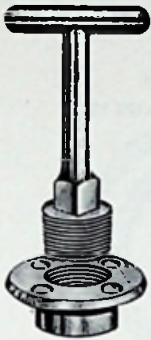

Fig. 263

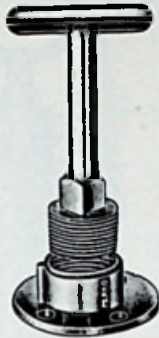

Fig. 266

The handle and plug are cast in one piece eliminating the need for a wrench. However if the plug should "freeze" into the flange a wrench may be used on the squared portion of the stem.

Each	Pipe Size Inches	Diam. Flange Inches	Depth Inches	Weight Ounces
\$3.85	3/4	2 3/8	3/8	11

**Garboard DRAIN PLUGS**

CAST BRONZE—BURNISHED



Fig. 714



Fig. 737



Fig. 714-A



Fig. 737-A

Figs. 737 and 737-A have extra brass flange and 3 F.H. machine screws, maximum space between flanges is 3/8 inches.

Fig.	Burnished Bronze Each	Pipe Size Inches	Diam. Flange Inches	Depth Inches	Weight Ounces
714	\$2.35	1/2	2	3/8	3
714-A	2.75	1/2	2	3/8	4
737	3.25	1/2	2	3/8	6
737-A	3.50	1/2	2	3/8	7

**New Garboard DRAIN PLUG**

CAST BRONZE—BURNISHED  
For Plywood, Fibreglass or Metal Boats



Fig. 363

Minimum space between nut and flange 3/16 inches.

Each	Pipe Size Inches	Diam. Flange Inches	Depth Inches	Weight Ounces
\$4.40	3/4	2 3/8	3/8	14

**Bronze Navy Pump STRAINERS**

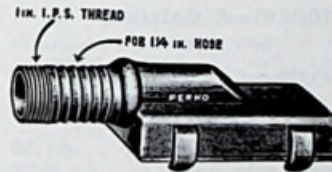

Fig. 704

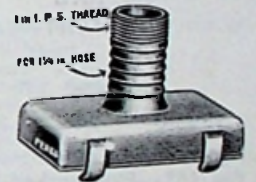

Fig. 705



Fig. 721



Fig. 722

Fig.	Each	Pipe Thread Inches	For Hose Inches	Length Inches	Width Inches	Weight Pounds
704	\$4.25	1	1 1/4	7	2 3/4	2
705	4.25	1	1 1/4	4 3/4	2 3/4	1 1/2
721	4.25	1 1/4		5	2 3/4	1 1/2
722	4.25	1 1/4		4 3/4	2 3/4	1 3/4

**Junior STRAINER**

CAST BRONZE  
FOR 3/8 INCH RUBBER HOSE



Fig. 709

Excellent for use with bilge pumps having 3/8 inch hose for intake such as our Fig. 202, etc.

Each	Length Overall Inches	Width Inches	Weight Ounces
\$2.40	4	1 1/4	6



**"Champion" Navy BILGE PUMP**  
FOR PIPE  
BRASS CYLINDER—CAST BRONZE PARTS  
WITH WEIGHTED LEATHER VALVE



Fig. 1016  
CAPACITY—16 STROKES—5 GALLONS

Each	Extreme Length Inches	Diameter Cylinder Inches	Inlet Pipe Thread Inches	Outlet Pipe Thread Inches	Diameter Plunger Rod Inches
\$30.00	24	2¾	1¼	1½	½

Fig. 147—Weighted leather valve only, each . . . . \$1.50  
Fig. 151—Flax packed plunger only, each . . . . . 2.75



Fig. 151  
Flax Packed Plunger



Fig. 147  
Weighted Leather Valve

**"Super" Navy BILGE PUMP**  
FOR HOSE OR PIPE  
WITH WEIGHTED LEATHER VALVE

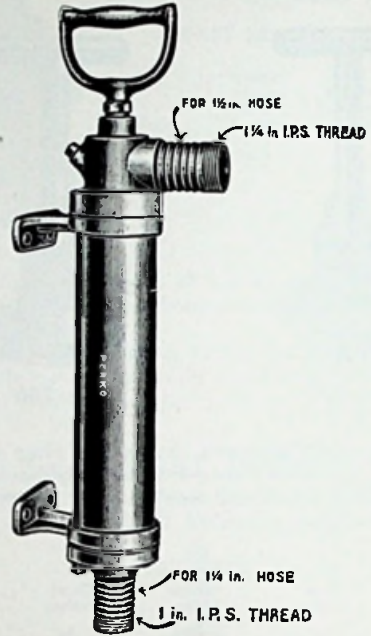

Fig. 701

This is our very popular "Champion" Pump improved by cast bronze integral fittings at inlet and outlet ends for connecting hose or pipe.

Each	Extreme Length Inches	Inlet Sizes		Outlet Sizes	
		Pipe Inches	Hose Inches	Pipe Inches	Hose Inches
\$30.00	27	1	1¼	1¼	1½

**"Junior" Navy BILGE PUMP**

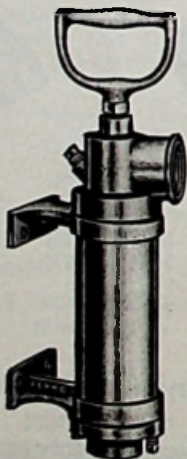

Fig. 1018

CAPACITY—16 STROKES—3 GALLONS

This is the Fig. 1016 "Champion" Pump reduced in length for installation in limited space.

Each	Extreme Length Inches	Diameter Cylinder Inches	Inlet Pipe Thread Inches	Outlet Pipe Thread Inches	Weight Inches
\$28.00	16¼	2¾	1¼	1½	5¼

**"Midget" Navy BILGE PUMP**

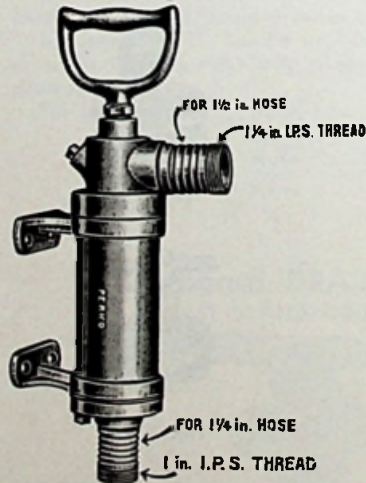

Fig. 702

Our Fig. 701 pump reduced in length for boats requiring a large capacity pump to be installed where space is limited.

Each	Extreme Length Inches	Diam. Cylinder Inches	Inlet Sizes		Outlet Sizes	
			Pipe Inches	Hose Inches	Pipe Inches	Hose Inches
\$28.00	18¼	2¾	1	1¼	1¼	1½



Fig. 108

Fig. 108 Plunger Assembly only, complete, No. 1 for pumps Figs. 702 and 1018, \$8.50 each, No. 2 for pumps Figs. 701 and 1016, \$9.90 each.



**Brass BILGE PUMPS**  
DOUBLE ACTION

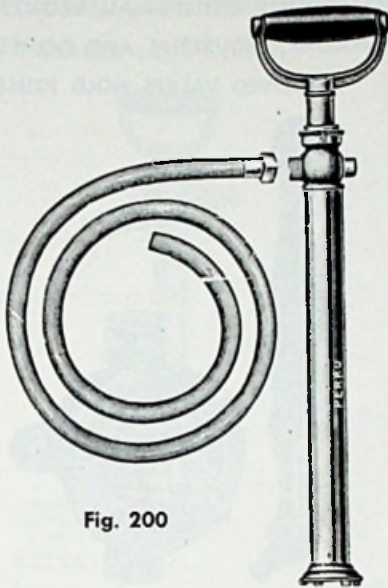

Fig. 200

Heavy brass seamless tubing, cast bronze fittings, treated leather packing, hollow brass ball checks. "D" shaped handle. Moulded rubber hose 5 feet long furnished with each pump.

No.	With Hose Each	Height Inches	Diam. Inches	Capacity Per Min. Gallons	Weight Pounds
1	\$10.35	17 $\frac{5}{8}$	1 $\frac{1}{8}$	5	2 $\frac{1}{4}$
2	14.00	20	1 $\frac{1}{2}$	10	3 $\frac{1}{4}$

Without hose, deduct \$.50 each.

**Brass BILGE PUMPS**  
DOUBLE ACTION

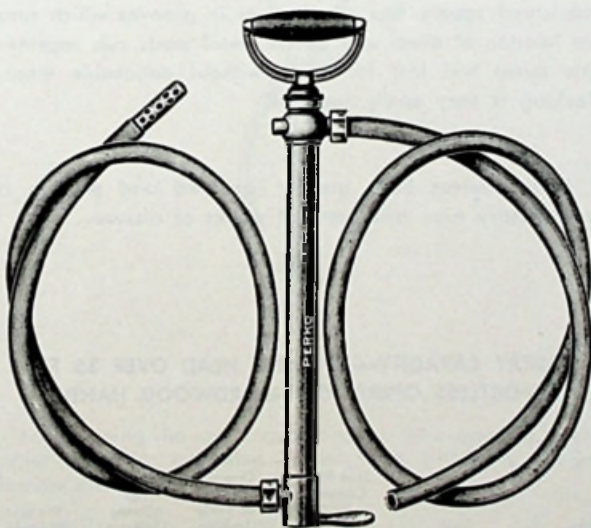

Fig. 202

Cast bronze foot rest and two 5 foot lengths of hose for suction and discharge.

No.	With Hose Each	Height Inches	Diameter Inches	Capacity Per Min. Gallons	Weight Pounds
5	\$13.60	18 $\frac{3}{8}$	1 $\frac{1}{8}$	5	3
6	17.65	21	1 $\frac{1}{2}$	10	4

Without hose, deduct \$.50 for each hose.

**"SEA JET"**  
Brass BILGE PUMP

NEOPRENE CAP, VALVE, PLUNGER AND HOSE  
HARD RUBBER FULL GRIP HANDLE

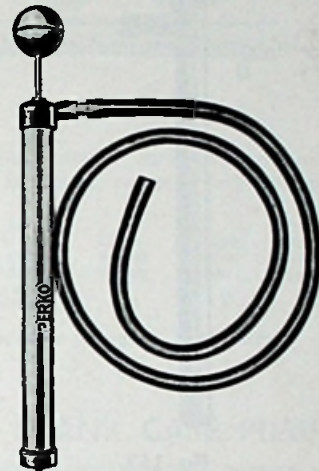

Fig. 183

The plunger and valve of neoprene will not dry out or rot. A long lasting pump for small boats.

CAPACITY, 14 STROKES PER GALLON

Complete Each	Diameter Tubing Inches	Height Overall Inches	Weight Pounds
\$6.50	1 $\frac{1}{4}$	17 $\frac{1}{2}$	2

**Brass BILGE PUMP**  
SINGLE ACTION

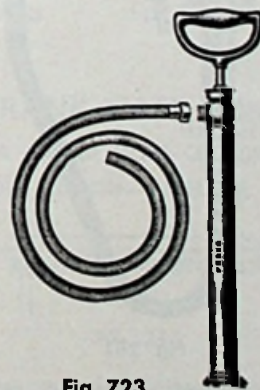

Fig. 723

Complete with 5 feet of rubber hose.

Has moulded neoprene rubber plunger producing excellent capacity. Capacity 2 $\frac{1}{2}$  gallons per minute.

With Hose Each	Without Hose Each	Diameter Inches	Extreme Length Inches	Weight Pounds
\$9.35	\$8.85	1 $\frac{1}{4}$	17 $\frac{3}{8}$	2



**Small Boat BILGE PUMP**

STEEL—ZINC PLATED  
GOOD CAPACITY—EASY OPERATION

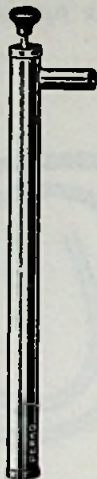

Fig. 152

These have felt retainer washer to prevent squirt through cap. Capacity—7 gallons per minute at normal speed.

	Each	Length Inches	Diameter Body Inches	Diameter Spout Inches	Weight Pounds
Steel	\$3.75	25	1½	⅞	2½

**Outboard BILGE PUMP**

ALL BRASS—WITH 3 FT. RUBBER HOSE  
BRASS BRACKETS FOR MOUNTING

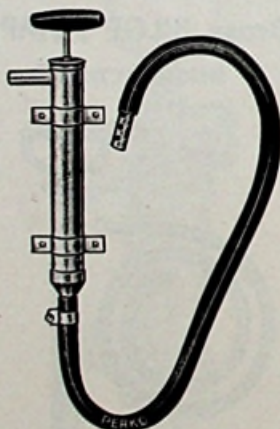

Fig. 201

For small boats, outboard motor, sail or rowboats.

Brackets permit permanent installation on transom or side allowing one hand pumping while boat is in use.

Complete with bronze intake strainer.

Each	Length Body Inches	Diam. Inches	Capacity Per Min. Gallons	Weight Pounds
\$9.00	11	1½	1½	2¼

**"Perko" WING PUMPS**

DOUBLE ACTION—ALL BRONZE  
FOR MARINE, INDUSTRIAL AND DOMESTIC USE  
IMPROVED VALVES HOLD PRIME

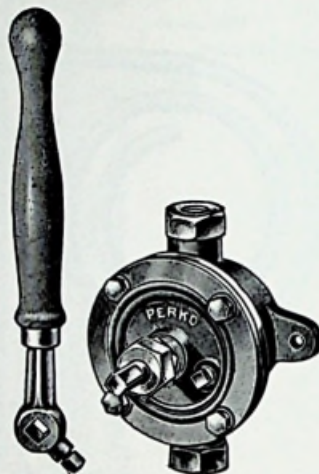

Fig. 681

Constructed entirely of cast bronze, principally for use as a marine bilge pump, but is used in large quantities in the industrial field for pumping oil and gasoline, hot liquids, juices, etc.

The interior consists of a cast bronze wing which oscillates on a bronze shaft connected to handle. The wing has lubricated square flax packing set in grooves which runs on interior of drum and as no metal parts rub together this pump will last for years without noticeable wear. Packing is very easily replaced.

Intake valves have greatly improved and priming is unnecessary even after several weeks of disuse.

GREAT CAPACITY—LIFT AND HEAD OVER 35 FT.  
EFFORTLESS OPERATION—HARDWOOD HANDLE

No.	Each	Size Pipe Connection Inches	Overall Diam. of Body Inches	Capacity Per Minute Gallons	Weight Pounds
0	\$54.50	½	5½	5	11½
1	63.00	¾	5¾	7	14
2	69.25	1	6¾	9¾	19½

Spare handles, complete, \$6.95 each. Wood only, \$1.20 each.



## Brass BILGE PUMPS

DOUBLE ACTION—WITH BULKHEAD BRACKETS  
 THREADED FOR 3/4 INCH PIPE



Fig. 345

Without Tail Pieces Each	With Tail Pieces Each	Length Overall Inches	Diam. Barrel Inches	Weight Pounds
\$20.50	\$22.85	21	1 1/2	3

Spare Parts, See Page 79.

Supplied with tail pieces if not otherwise specified.

## CRANK CASE PUMP

DOUBLE ACTION—ALL BRASS



Fig. 146

For draining the crank case through filler opening, with outlet spout for attaching rubber hose. Intake is bronze flexible metal hose.

Capacity—30 strokes per gallon.

Complete Each	Spare Intake Hose Each	Length Overall Inches	Length Intake Hose Inches	Diam. Pump Inches	Weight Pounds
\$13.00	\$4.00	17 1/2	12 1/2	1 1/8	2 1/2

NOTE—Above supplied with intake tube for 3/8 inch rubber hose instead of metal hose illustrated, specify Fig. 1029, \$10.00 each.

## CRANK CASE PUMP

SINGLE ACTION—ALL BRASS  
 WITH BRONZE FLEXIBLE METAL HOSE  
 OUTLET SPOUT AND NEOPRENE PLUNGER

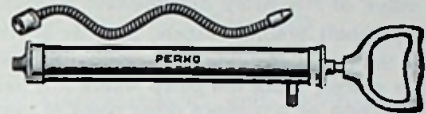

Fig. 388

Outlet spout permits continuous operation. The new plunger has increased capacity with smoother operation.

Complete Each	Spare Intake Hose Each	Diam. Barrel Inches	Length Barrel Inches	Length Overall Inches	Weight Pounds
\$9.25	\$3.65	1 1/2	12	15 1/2	2

Spare Neoprene plungers, \$.35 each.

## CRANK CASE PUMP

WITH FLEXIBLE METAL INTAKE HOSE  
 SINGLE ACTION—STEEL OR BRASS

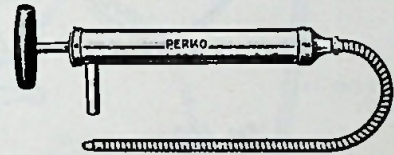

Fig. 336

Steel pump is painted red. Brass pump is in natural finish.

Flexible intake hose is 18 inches long, 1/2 inch outside diameter. Outlet spout is 2 1/8 inches long, 3/8 inches outside diameter.

Steel Each	Brass Each	Length Body Inches	Diam. Body Inches	Weight Pounds
\$4.60	\$7.00	11	1 1/2	1 1/2

## CRANK CASE PUMP

FOR RUBBER HOSE OR TUBING  
 SINGLE ACTION—STEEL OR BRASS

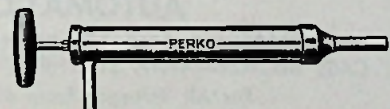
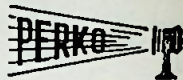

Fig. 335

Steel pump is painted red. Brass pump is in natural finish.

Inlet and outlet tubes will fit 3/8 inch rubber hose or tubing, so equipped, this pump may also be used as a bilge pump for small boats.

Steel Each	Brass Each	Length Body Inches	Diam. Body Inches	Weight Pounds
\$3.75	\$6.00	11	1 1/2	1 1/2



## PERKO IMPROVED "FLEXO-SHAFT" ELECTRIC BILGE PUMPS

Patented

WITH FLEXIBLE PHOSPHOR BRONZE DRIVE SHAFT AND WATERPROOF CASING  
CASING HAS "TEMFLEX" PLASTIC COVERING TO INCREASE ITS STRENGTH  
ALL BRONZE EXCEPT MOTOR—BURNISHED FINISH.

The value of this pump arrangement is obvious at first sight.

Pass the shaft around corners, over or under bulkhead, ribs or any other obstructions and it operates.

Mount the motor anywhere, in a cabin, pilot house, or out in the cockpit far removed from gasoline fumes that usually settle in low places; place the pump where it is needed at the moment, at the lowest point of the bilge, under the engine, under low decking or any place other types of pumps cannot reach.

Inlet is through base which has heavy gauge brass strainer. Outlet is illustrated and is for 1 inch rubber hose, or 1/2 inch pipe.

CAPACITY—500 gallons per hour at 1 foot

MAXIMUM HEAD—8 feet, with 3 foot shaft.

MOTOR IS LOW AMPERAGE 1/40 H.P. at 2000 R.P.M.

WITH DIRECT DRIVE

WITH ANGLE DRIVE

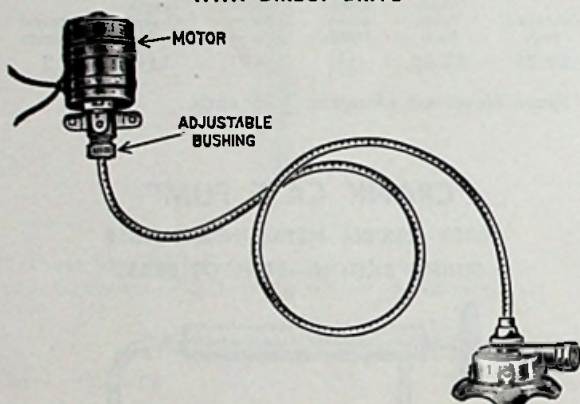

Fig. 666

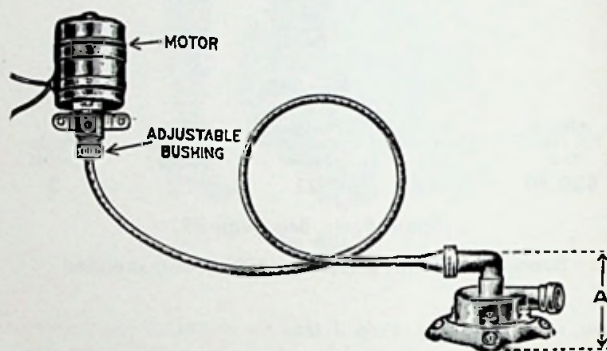

Fig. 689

Height Pump Inches	Diam. Base Inches	Weight Pounds	Height at "A" Inches	Diam. Base Inches	Weight Pounds
4 1/4	4 1/4	7	3 1/8	4 3/8	7 1/2
	6 Volt Each	12 Volt Each		6 Volt Each	12 Volt Each
With 3 ft. shaft	\$42.50	\$42.50	With 3 ft. shaft	\$49.00	\$49.00
With 6 ft. shaft	47.50	47.50	With 6 ft. shaft	54.00	54.00
Motor only	12.00	12.00	Motor only	12.00	12.00

CAPACITY WITH 4 FOOT HEAD—300 GALLONS PER HOUR

CAPACITY WITH 8 FOOT HEAD—120 GALLONS PER HOUR

### SPARE PARTS

3 Foot shafts only	\$10.00 Each.	Fig. 689 Mitre Gears with shaft	\$4.00 Per Pair
6 Foot shafts only	14.75 Each	Fig. 689 Angle Elbow Less Gears	4.00 Each
Fig. 666 Complete Pump Unit only	18.50 Each	Motor Bulkhead Bracket only	4.50 Each
Fig. 689 Complete Pump Unit only	25.50 Each	NOTE—See page 90 for "Pipe to Hose" coupling, which permits attaching 3/8 inch hose to above pumps.	
Impeller only	1.50 Each		

## AUTOMATIC SWITCH FOR BILGE PUMPS

PRESSURE OPERATED DIAPHRAGM TYPE—FOR NON-AUTOMATIC BILGE PUMPS  
CAST BRONZE—WITH SYNTHETIC RUBBER DIAPHRAGM—HEAVY DUTY MECHANICAL SWITCH

For All Voltages From 6 to 110

This device consists of a very sensitive switch in contact with a diaphragm of oil and grease resistant material. The wires are led through a neoprene hose above any normal water level.

This switch will start the pump operating when the water reaches the top of the switch or 2 1/4 inches. It will turn off again when the water reaches a depth of 1 inch but by connecting 1/4 inch tubing to the 1/8 inch pipe tapped end of switch and into the discharge line of the pump the pressure in the pump discharge line will continue to operate the switch until the pump sucks air.

Burnished Complete Each	Spare Switch Each	Spare Diaphragm Each	Height Inches	Diam. Base Inches	Weight Pounds
\$17.50	\$3.00	\$1.10	2 1/4	4 1/4	2

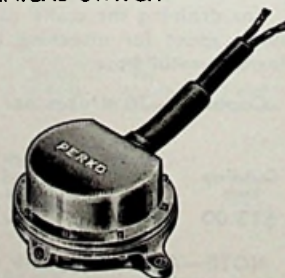

Fig. 662



**PERKO IMPROVED "FLEXO-SHAFT" AUTOMATIC ELECTRIC BILGE PUMPS**

Patented

**FLEXIBLE PHOSPHOR BRONZE DRIVE SHAFT AND WATERPROOF CASING**  
**CASING HAS "TEMFLEX" PLASTIC COVERING TO INCREASE ITS STRENGTH**  
**PRESSURE OPERATED DIAPHRAGM TYPE AUTOMATIC SWITCH—THREE-WAY DASHBOARD SWITCH**  
**ALL BRONZE EXCEPT MOTOR—6 AND 12 VOLTS—BURNISHED FINISH**  
**WATERTIGHT—OPERATES WITH PUMP AND SWITCH HOUSING SUBMERGED**

**FEATURES**—See write up on Figs. 666 and 689 (opposite page) for installation and other features.

**BREATHER TUBE**—Is heavy flexible "Koroseal," 18 inches long with 1/8 inch wall.

**THREE-WAY DASHBOARD SWITCH**—Is indicated "Off," "Automatic" and "Non-automatic" and permits remote control accordingly.

**ADJUSTABLE BUSHING**—For adjustment of tension on drive shaft to assure full R.P.M. of pump impeller.

**AUTOMATIC SWITCH**—Starts pump operating when bilge water reaches a depth of about 1 1/2 inches and will "Shut off" at a depth of about 3/4 inch.

**CAPACITY**—500 gallons per hour at 1 foot head—300 gallons at 4 feet—120 gallons at 8 feet. Maximum head 8 feet with 3 foot shaft.

**MOTOR**—Low amperage 1/40 H.P. at 2000 R.P.M.

**WITH DIRECT DRIVE**

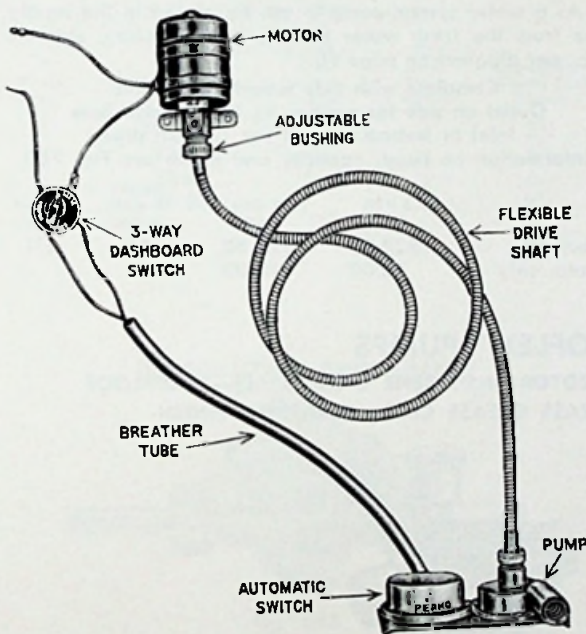

**Fig. 742**

**WITH ANGLE DRIVE**

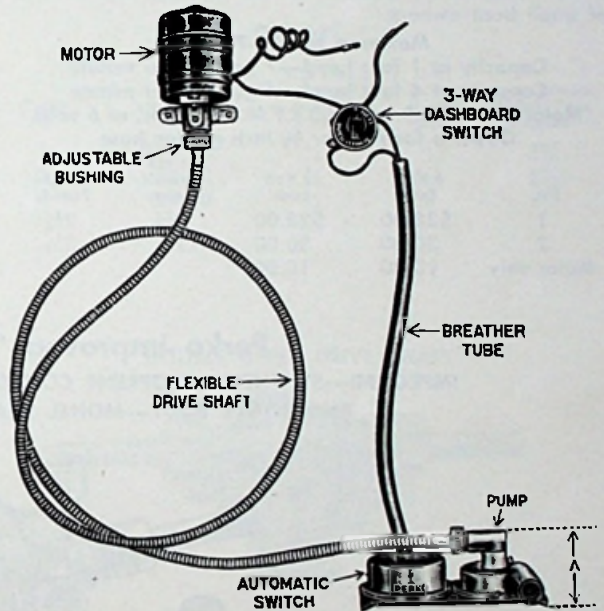

**Fig. 743**

	Fig. 742		Fig. 743		Fig. 742	Fig. 743	Size Base Inches	Weight Pounds
	6 Volt Each	12 Volt Each	6 Volt Each	12 Volt Each	Height Pump Inches	Height at "A" Inches		
With 3 foot shaft	\$65.00	\$65.00	\$71.50	\$71.50	2 1/2	2 3/4	7 x 4	8
With 6 foot shaft	70.00	70.00	76.50	76.50	2 1/2	2 3/4	7 x 4	8

Spare pump unit, complete except motor and shaft, Fig. 742, \$34.00 each, Fig. 743, \$39.00 each.

Spare 3-way dashboard switches, \$4.00 each.

Other spare parts, see page 86.

**Perko "Flexo-Shaft" WATER SYSTEM PUMP**

**WITH PIPE INLET AND OUTLET—1/2 INCH**  
**CAST BRONZE—BURNISHED FINISH**

Supplied complete with Flexible Drive Shaft and Motor per Fig. 666 Page 86. See Page 90 for diagram of installation. Capacity same as Fig. 666.

	6 Volt Each	12 Volt Each	Height Pump Inches	Weight Pump only Pounds
With 3 foot shaft	\$42.50	\$42.50	3 1/4	2
With 6 foot shaft	47.50	47.50	3 1/4	2

Pump only as illustrated, no shaft or motor, \$16.00 each.

**NOTE**—This pump does not have the ability to lift water from below the pump level, therefore, it is not intended for use as a bilge pump.

See Page 90 for "Pipe to Hose" coupling, for attaching hose to above pumps.

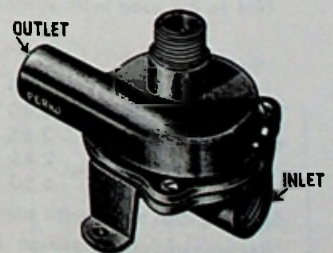

**Fig. 748**



## "Junior" Electric BILGE PUMP

NON-AUTOMATIC—6 OR 12 VOLTS  
ALL BRASS EXCEPT MOTOR  
BAKED GRAY FINISH—NYLON BEARINGS



Fig. 780

The result of a determined effort to produce a good practical electric bilge pump of high capacity at a price as low as possible and within the means of the majority of small boat owners.

Maximum head—7 feet  
Capacity at 1 foot head—7 gallons per minute  
Capacity at 4 foot head—4 gallons per minute  
Motor is 1/40 H.P. at 2000 R.P.M.—8 amps. at 6 volts  
Outlet is for regular 5/8 inch garden hose

No.	6 Volt Each	12 Volt Each	Height Overall Inches	Weight Pounds
1	\$28.00	\$28.00	8½	2¾
2	30.00	30.00	12	3¼
Motor only	10.00	10.00		

## BAIT TANK or WATER SYSTEM PUMP

ELECTRIC—6 OR 12 VOLTS  
ALL BRASS EXCEPT MOTOR  
BAKED GRAY FINISH—NYLON BEARINGS

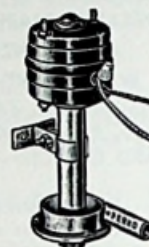

Fig. 781

When installed at or below the water line this pump is ideal for keeping the bait tank supplied with constant water changes.

As a water system pump it can be placed in the supply line from the fresh water tank to sink, lavatory, shower, etc., per diagram on page 90.

Complete with side mounting bracket  
Outlet on side for regular 5/8 inch garden hose  
Inlet in bottom tapped for 1/2 inch pipe  
Information on head, capacity and motor see Fig. 780

	6 Volt Each	12 Volt Each	Height Overall Inches	Weight Pounds
Complete	\$27.50	\$27.50	8½	2¾
Motor only	10.00	10.00		

## Perko Improved "ROTOFLEX" PUMPS

IMPROVED—SYNTHETIC NEOPRENE COMPOUND ROTOR—NEOPRENE U-CUP SEALS—LEAKPROOF  
ALL BRONZE BODY—MONEL SHAFT—BRASS GREASE CUPS—BURNISHED FINISH

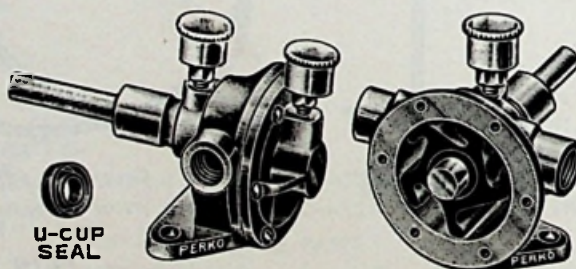

Fig. 696

Quiet operation—long continuous service—large capacity at low speed—for use with salt water, oil and tars self priming—will pump in either direction.

The rotor is a synthetic compound of neoprene and other chemicals resulting in high resistance to abrasion or wear, is impervious to oil and other impurities. The vanes of the rotor are highly flexible yet tough enough to resist the wear encountered by the passage of sand and other foreign matter; produce the necessary high vacuum and stand the continuous flexing as the rotor revolves.

The use of U-cup seals eliminates packing and packing glands.

Lift in feet, 25 to 30. Head in feet, 30 to 40.

Not to be used with synthetic solvents such as gasoline, naphtha, etc.

No.	Each	Spare Rotors Each	Size Pipe Connection Inches	Diam. Shaft Inches	Extreme Height Inches	Extreme Width Inches	Extreme Length Inches	Dimensions Base Inches	Capacity G.P.M.			Weight Pounds
									600 R.P.M.	*1000 R.P.M.	1500 R.P.M.	
2	\$16.00	\$1.65	3/8	1/2	3½	3½	6¼	3 x 1¾	4.1	4.9	6.4	2¾
3	21.00	2.40	1/2	3/8	3¾	4	6¾	3¾ x 2¼	7.1	8.5	11.0	3¾
4	25.50	2.85	3/4	3/8	4	4½	8¾	4 x 3	13.0	16.5	22.0	5¾
5	30.50	2.85	1	3/8	4	5	8¾	4½ x 3	15.7	19.2	26.0	6
6	56.75	6.50	1¼	3/8	5	7¼	9¾	5½ x 3½	19.5	33.5	48.0	14

Spare U-cup seals with brass retainer—\$.60 each. Specify size of shaft.

\*Recommended maximum for continuous duty. Capacity shown based on 0 lbs. pressure. With special length of shaft, price on application. Motor recommended 1/4 to 1/2 H.P. for sizes No. 2-3-4-5 and up to 3/4 H.P. for size No. 6.





## "PERKO" BRONZE GEAR TYPE PUMPS

SIZES NO. 3 AND 4 HAVE DROP FORGED BRONZE BODIES

The entire interior, including bearings, is tool machined, insuring perfect alignment and absolutely tight joints, blank bearing ends are solid (not soldered), all bearings are fully lubricated by brass grease cups. The drive shaft is in perfect alignment with the pump body. Pipe connections are Briggs standard pipe tap.

### SINGLE LOWER DRIVE SHAFT

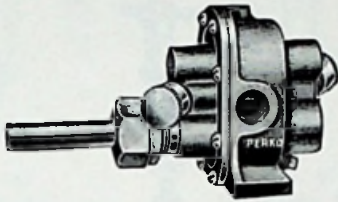

Fig. 684

Pump No.	With Spur Gears Each	Size Pipe Connection Inches	Size Drive Shaft Inches	Approximate Weight Each Pounds
2	\$21.75	1/4	1/2	3 3/4
3	24.90	3/8	5/8	5 1/2
4	28.00	1/2	3/4	6
9	36.50	1	3/4	9 1/2

### SINGLE UPPER DRIVE SHAFT

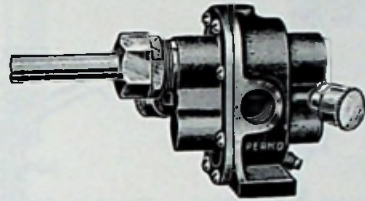

Fig. 682

Pump No.	With Spur Gears Each	Size Pipe Connection Inches	Size Drive Shaft Inches	Approximate Weight Each Pounds
2	\$21.75	1/4	1/2	3 3/4
3	24.90	3/8	5/8	5 1/2
4	28.00	1/2	3/4	6

### DOUBLE LOWER DRIVE SHAFT

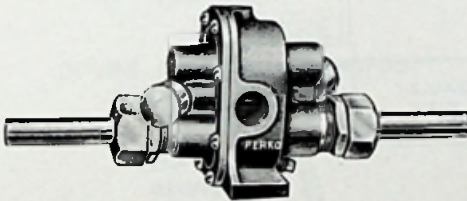

Fig. 685

Pump No.	With Spur Gears Each	Size Pipe Connection Inches	Size Drive Shaft Inches	Approximate Weight Each Pounds
2	\$25.50	1/4	1/2	4 1/2
3	30.50	3/8	5/8	6 1/4
4	31.50	1/2	3/4	6 3/4

### DOUBLE UPPER DRIVE SHAFT

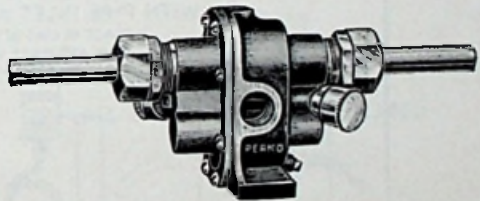

Fig. 683

Pump No.	With Spur Gears Each	Size Pipe Connection Inches	Size Drive Shaft Inches	Approximate Weight Each Pounds
2	\$25.50	1/4	1/2	4 1/2
3	30.50	3/8	5/8	6 1/4
4	31.50	1/2	3/4	6 3/4

NOTE—Figs. 682 and 684 in all sizes except 1 inch are reversible. That is, any person, dealer, user, etc., can change a lower shaft pump to "upper shaft" or vice versa in a few minutes.

NOTE—Don't fail to state figure and pump number desired.

CAUTION—When above pumps are operated by belt and pulley be sure to use intermediate bearing on shaft.

### GEAR PUMP PARTS

Pump No.	Spur Gears Each	Drive Shaft Each	Idle Shaft Each
2	\$3.00	\$2.50	\$1.75
3	3.00	3.00	2.25
4	3.75	3.00	2.25

### CAPACITY TABLES FOR GEAR PUMPS AT 1725 R.P.M. PRESSURE AND GALLONS PER MINUTE

Pump No.	2 Lbs.		20 Lbs.		40 Lbs.		60 Lbs.		80 Lbs.	
	H.P.	G.P.M.	H.P.	G.P.M.	H.P.	G.P.M.	H.P.	G.P.M.	H.P.	G.P.M.
2	1/4	1.5	1/4	1.5	1/4	1.5	1/4	1.5	1/4	1.5
3	1/2	3.0	1/2	3.0	3/4	4.5	1	6.0	1 1/2	9.0
4	1/2	3.0	3/4	4.5	1	6.0	1 1/2	9.0	2	12.0
9	1	6.0	1 1/2	9.0	2	12.0	3	18.0	4	24.0

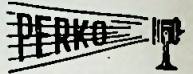

## "Perko" Electric WATER FAUCETS

ALL CAST BRONZE—WITH ADJUSTABLE SPOUT—6 AND 12 VOLTS

TURN THE HANDLE AND THE WATER STARTS TO FLOW. NO HAND PUMPING OR PRIMING NECESSARY.

Connect one or several of the faucets to our Figure 748 electric pump. (See below for suggested installation.) Water is then supplied to your sink or lavatory as easily as in your home. All connections are threaded for 1/2 inch pipe.

WITH HAND SWITCH

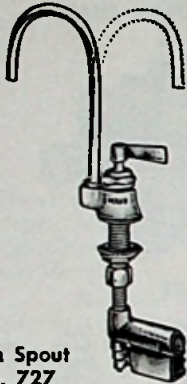

High Spout  
Fig. 727

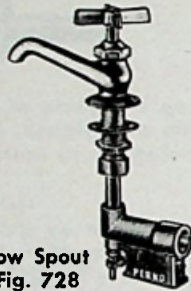

Low Spout  
Fig. 728

SELF CLOSING TYPE

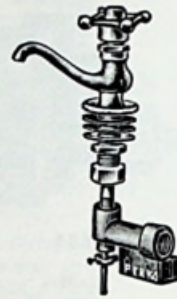
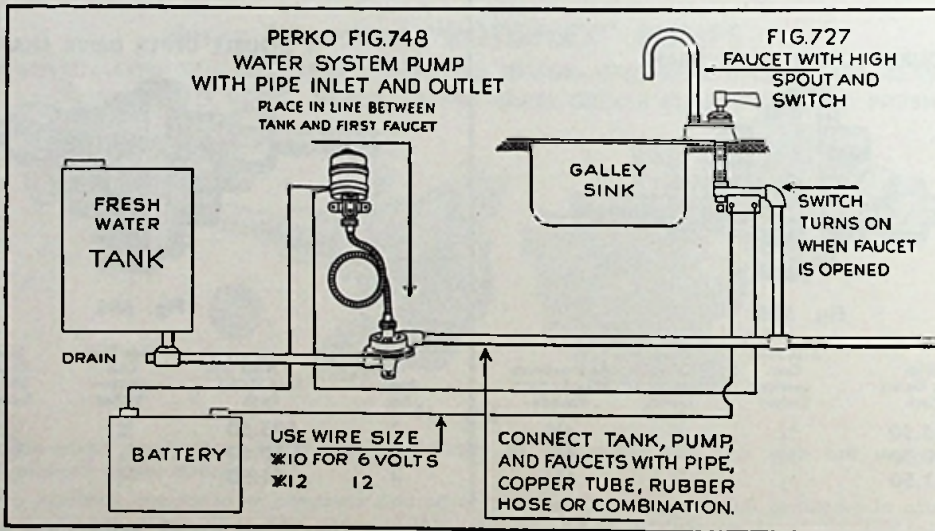

Fig. 740

Fig.	Chromium Plated Each	Height Above Drain Board Inches	Length Below Drain Board Inches	Weight Pounds
727	\$27.00	8 3/4	5 1/2	2 1/2
728	19.75	3 1/4	5 1/2	2

Chromium Plated Each	Height Above Drain Board Inches	Spout Projection Inches	Weight Pounds
\$24.50	3 3/8	2 5/8	2 1/2



## Bronze Utility CHECK VALVE

WITH BRASS BALL CHECK



Fig. 265

Ideal for holding prime in the inlet line of galley and lavatory pumps, bilge pumps, etc. Threaded both ends.

Each	Pipe Size Inches	Length Inches	Weight Ounces
\$2.25	1/2	1 1/4	3 1/2

## Brass "Pipe To Hose" COUPLINGS

1/2" PIPE TO 3/8" HOSE

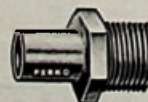

Male Pipe Thread  
Fig. 210



Female Pipe Thread  
Fig. 212

Each	Length Overall Inches	Length Hose Couplings Inches	Weight Ounces
\$1.25	1 1/2	3/4	2 1/4



**Improved Galley and Lavatory PUMPS**  
BRONZE—CHROMIUM PLATED

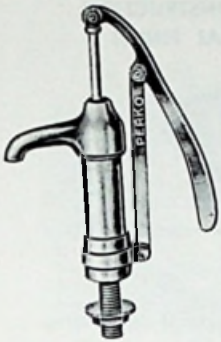

Fig. 467  
Metal Handle

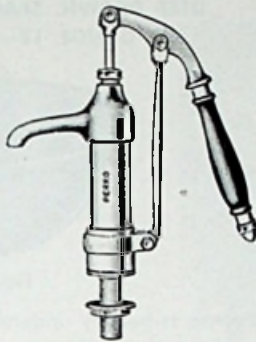

Fig. 473  
Mahogany Handle



Fig. 144

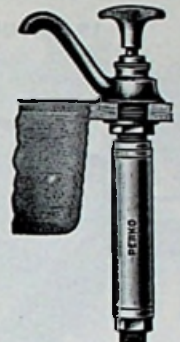

Fig. 1040

**IMPROVED INLET VALVE TO HOLD PRIME**  
WITH LEAKPROOF NEOPRENE U-CUP SEALS

**FLARED FLANGE — NEOPRENE PLUNGER**  
IMPROVED VALVE TO HOLD PRIME

Length of stroke is 5¼ inches.

Inlet is threaded for ¾ inch pipe.

Fig.	Diam. Barrel Inches	Length Barrel Inches	Length Neck Inches	Threaded For Pipe Inches	Weight Pounds
467	1½	6½	2½	½	3½
473	1½	6	2½	½	3½

Fig.	Diam. Barrel Inches	Length Overall Inches	Projection Spout Inches	Height Spout Inches	Weight Pounds
144	1½	13½	3	0	3
1040	1½	14½	4½	3	3½

Fig.	Chromium Plated Each	Chromium Plated Handle Only Each	Mahogany Grip Only Each
467	\$29.50	\$4.50	
473	30.50	5.50	\$1.05

—Exposed Parts Only—  
Chromium Plated Each

Fig.	Chromium Plated Each	Repair Kits Each
144	\$23.00	\$2.75
1040	25.00	2.75

Repair Kit, each \$3.00.

**ANGLE TYPE**  
DOUBLE ACTION—SWIVEL SPOUT  
EFFORTLESS OPERATION

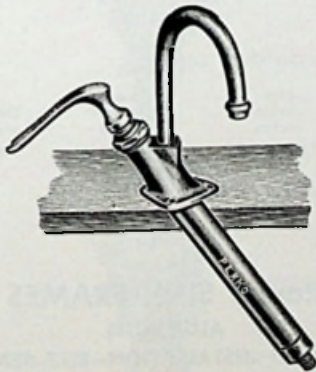

Fig. 677

Angle toward user when installed permits easy effortless operation.

Spout swivels to various positions.

Bottom valve is an improved type to hold prime.

Capacity, 10 strokes per quart.

No.	Chromium Plated Each	Inlet Pipe Size Inches	Spout Projection Inches	Height Flange to Spout Inches	Weight Pounds
1	\$13.75	¾	3½	4¾	1¼
2	17.50	¾	4	4¾	2¼

Repair Kit, each \$1.50

**"EZY-FLO"**  
ALL BRASS—CHROMIUM PLATED

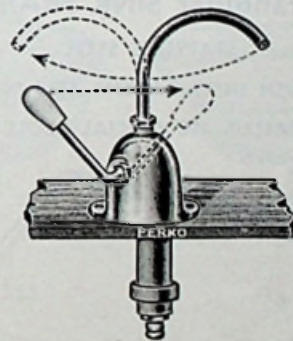

Fig. 177

Finger tip control, easy operation, self priming.  
Handle operates with short rocking strokes so effortless a child can work it.

Spout swivels to any direction desired.

Inlet fits ¾" rubber hose or ¾" pipe.

Capacity—20 strokes per quart.

Each	Extreme Height Above Drain Board Inches	Dimensions Mounting Base Inches	Weight Pounds
\$27.00	8	4x1¾	2¼

Repair Kit, each \$4.15



## Stainless Steel SINKS

DEEP DRAWN, SEAMLESS CONSTRUCTION  
19 GAUGE 18-8—NATURAL FINISH

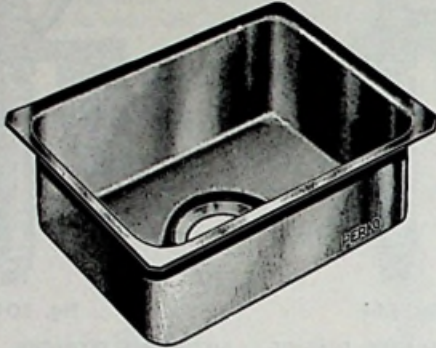

Fig. 356

Corrosion resistant and immune to rust.  
No crevices for dirt or bacteria to collect.  
No painted or coated surface to crack or wear off.  
Bottom is heavily undercoated for sound deadening.  
Packed in individual cartons.

No.	Each	Size Inside Inches	Size Outside Inches	Depth Inside Inches	Weight Pounds
1	\$26.00	9 $\frac{1}{8}$ x 13 $\frac{3}{8}$	11 $\frac{1}{4}$ x 15 $\frac{1}{4}$	5	4
2	32.50	11 $\frac{1}{2}$ x 16 $\frac{3}{4}$	13 $\frac{1}{2}$ x 18 $\frac{3}{4}$	6	6 $\frac{1}{2}$
3	39.50	11 $\frac{5}{8}$ x 19 $\frac{5}{8}$	13 $\frac{5}{8}$ x 21 $\frac{1}{8}$	7	7 $\frac{1}{2}$
4	63.00	16 x 20	18 x 22	8 $\frac{1}{2}$	9 $\frac{1}{2}$

Drain fittings for above, see fig. 357.

## Rectangular SINK FRAMES

STAINLESS STEEL

FOR FLUSH INSTALLATION—SELF SEALING

EASILY INSTALLED—NO SPECIAL TOOLS REQUIRED

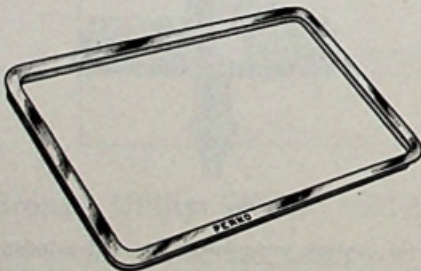

Fig. 347

Complete with mounting lugs, bolts and corner brackets.

No.	Each	For Sink Outside Dimensions Inches
1	\$ 9.90	11 $\frac{1}{8}$ x 15 $\frac{1}{8}$
2	10.10	13 $\frac{1}{2}$ x 18 $\frac{3}{4}$
3	10.10	13 $\frac{5}{8}$ x 21 $\frac{1}{8}$
4	10.50	18 x 22

## Stainless Steel SINKS

ROUND

DEEP DRAWN, SEAMLESS CONSTRUCTION  
20 GAUGE 18-8 NATURAL FINISH

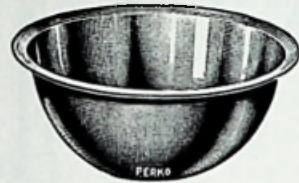

Fig. 271

Bottom is heavily undercoated for sound deadening.  
Packed in individual cartons.

No.	Each	Diameter Inside Inches	Diameter Outside Inches	Depth Inside Inches	Weight Pounds
6	\$14.75	10 $\frac{1}{4}$	12 $\frac{3}{4}$	5	2

Drain fitting for above, see fig. 586.

## Pressed Steel SINK

WHITE PORCELAIN ENAMELED  
FLAT RIM

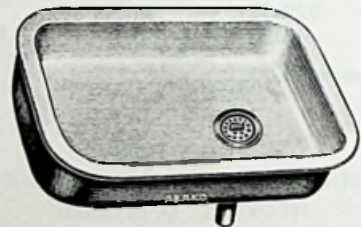

Fig. 402

Packed in individual cartons.

Sink Only Each	Size Inside Inches	Size Outside Inches	Depth Inches	Weight Pounds
\$10.25	10 $\frac{1}{2}$ x 16	12 $\frac{3}{4}$ x 18	4 $\frac{3}{4}$	4

Drain fittings for above, see fig. 586.

## Round SINK FRAMES

ALUMINUM

FOR FLUSH INSTALLATION—SELF SEALING

EASILY INSTALLED—NO SPECIAL TOOLS REQUIRED



Fig. 181

Complete with mounting lugs, bolts, and corner brackets.

No.	Each	For Sink Outside Diameter Inches
6	10.00	12 $\frac{3}{4}$



### LAVATORIES

WHITE VITREOUS CHINA LAVATORIES WITH INTEGRAL BACK AND ROUND BASIN OVERFLOW.

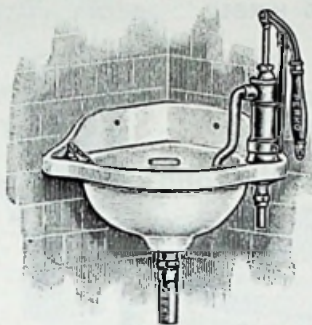

Fig. 830  
Corner Type



Fig. 831  
Flat Back



Fig. 832  
Flat Back

Fitted with chromium plated waste plug, chainstay, chain, stopper and tail piece.

Fig.	No.	Without Pump or Faucet Each	With Faucet Each	Lavatory Size Inches	Diameter Basin Inches	Diameter Outlet Inches	Diameter Pump Inlet Inches	Height Back Inches
830	1	\$43.25	\$52.75	12x12	10	1 1/4	1/2	2 1/2
	2	53.75	63.25	14x14	11	1 1/4	1/2	2 1/2
831		35.75	45.25	12x12	10	1 1/4	1/2	2 1/2
832		42.00	51.50	14x14	11	1 1/4	1/2	2 1/2

NOTE: Pumps for above, see Figs. 144-467-473-1040. Faucets are Chromium plated bronze, marked "Hot" or "Cold", please specify. All above furnished without pump or faucet unless otherwise specified.

### DRAIN FITTINGS

WITH TAIL PIECE FOR HOSE



Fig. 357



Fig. 586

Fig.	Each	Opening In Sink Inches	Diameter Tail Piece Inches	Weight Ounces
357	\$5.75	3 1/2	1 1/2	20
586	2.50	2	1 1/2	10

Fig. 357 is stainless steel and is for sink fig. 356.

Fig. 586 is brass, chromium plated and is for sinks Figs. 271 and 402.

### LUCITE LAVATORIES

CHIP PROOF—HEAT RESISTANT—RESILIENT

LIGHTWEIGHT—IMPERVIOUS TO RUST

LUSTROUS WHITE



Fig. 823

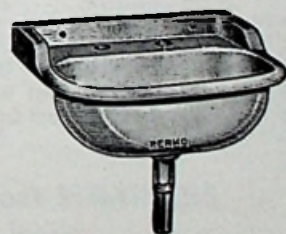

Fig. 825

These sturdy basins have all the appearance of fine vitreous china and will perform all the functions of same while providing light weight and lower cost.

Will accommodate regular faucets or our various lavatory pumps.

Supplied complete with 1 1/4 inch tail piece for outlet.

Fig.	Each	Size Inches	Size Basin Inches	Height Back Inches	Weight Pounds
823	\$19.25	14 x 15 1/4	12 x 9	1 3/4	13
825	19.25	14 1/4 x 12 1/4	12 1/2 x 7 1/2	1 1/4	



**PERKO IMPROVED MARINE CLOSETS**

FOR ABOVE OR BELOW WATERLINE  
 WHITE VITREOUS CHINA BOWL — RIM FLUSHING TYPE  
 ALL BRONZE PUMP AND FITTINGS—WHITE PAINTED FINISH  
 ALL WHITE SEATS AND COVERS — BRASS CHROMIUM PLATED HINGES  
 INLET HAS TAILPIECE FOR 3/8 INCH HOSE  
 OUTLET HAS TAILPIECE FOR 1 1/2 INCH HOSE  
 OUTLET TAILPIECE HAS NEOPRENE "JOKER" BACKWATER CHECK VALVE  
 WASTE ARM HAS 1/2 INCH PIPE SIZE DRAIN OUT OPENINGS

**The "Boatman"**

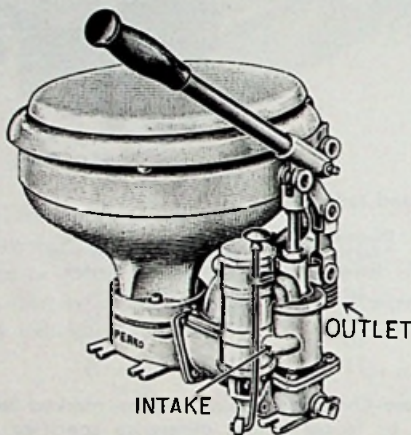

Fig. 828-D With Hand Valve  
 Fig. 829-D With Foot Valve

Handle can be changed to vertical position by anyone in a few minutes.

Height With Cover Inches	Height Without Cover Inches	Width Side to Side Inches	Depth Front to Back Inches	Size Inches Base	Weight Pounds
13 1/4	12 1/8	17	16	12x5	40

No.	Each
1 Fig. 828-D with Seat and Cover	\$96.00
2 Fig. 828-D With Seat Only	95.00
3 Fig. 829-D With Seat and Cover	98.00
4 Fig. 829-D With Seat Only	97.00

**Toilet Parts and Repair Kits**

The following kits are complete with all parts likely to wear out such as all gaskets, valves, packing, washers, seals and leathers.

	Per Kit
Fig. 836 for Fig. 833 No. 1 and 2	\$6.40
Fig. 836-A for Fig. 833 No. 3 and 4	7.70
Fig. 909 for Figs. 828-D and 829-D	7.50

	Each
Fig. 844 White Seat and Cover Complete	\$9.00
Fig. 845 White Seat, No Cover, Complete	7.00
Fig. 846 White Vitreous Bowl Only	22.00
Fig. 849 Neoprene Joker Valve Only	1.30
Fig. 855 Neoprene Clack Valve Only	1.00
*Fig. 856 Conversion Kit for Fig. 833	9.50

\*This kit contains a joker valve with necessary castings for converting Fig. 833 No. 1 or 2 to No. 3 or 4.

**The "Little John"**

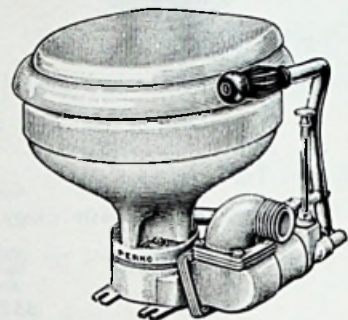

Fig. 833

This compact little closet was designed primarily for small boats where space is limited.

Supplied only as illustrated, with horizontal handle and hand valve.

Height With Cover Inches	Height Without Cover Inches	Width Side to Side Inches	Depth Front to Back Inches	Size Base Inches	Weight Pounds
13 1/4	12 1/8	15	16	9x5	32

No.	Each
1 Without Joker Valve, with seat and cover	\$85.75
2 Without Joker Valve, with seat only	84.25
3 With Joker Valve, with seat and cover	92.50
4 With Joker Valve, with seat only	91.00

**Bronze SEA COCKS WITH DRAIN PLUGS—ROUND WAY REMOVABLE HANDLE**



Fig. 834



Fig. 835

Size Inches	Fig. 834 Each	Fig. 835 Each	With Fig. 86 Strainer Add Each	Size Strainer Inches	Without Hull Connection Deduct Each
3/4	\$19.50	\$18.70	\$1.30	3 1/2	\$2.20
1	25.50	24.60	1.30	3 1/2	2.95
1 1/4	31.70	30.80	1.75	4 1/4	4.20
1 1/2	33.60	37.90	2.65	5	5.25
2	66.00	64.90	3.40	6	7.70



## Thru Hull CONNECTIONS

CAST BRONZE—BURNISHED

WITH AND WITHOUT TAIL PIECE

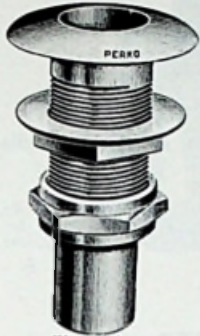

Fig. 64

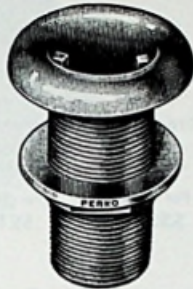

Fig. 322

Pipe Size Inches	Fig. 64 Each	Fig. 322 Each	Length Neck Inches	O.D. Tail Piece Inches	Diam. Flange Inches	Wt. Fig. 64 Lbs.	Wt. Fig. 322 Lbs.
3/8	\$3.00	\$2.10	2 3/8	1/2	1 3/8	3/8	1/4
1/2	3.45	2.30	2 3/8	1/2	1 3/8	1/2	3/8
3/4	4.35	2.95	2 3/8	3/4	2	5/8	1/2
1	6.00	4.00	2 3/8	1	2 1/4	1	3/4
1 1/4	8.35	6.00	3 1/2	1 1/4	2 3/8	1 3/4	1 1/2
1 1/2	10.95	7.45	3 3/4	1 1/2	3	2 1/8	1 3/4
2	15.80	11.00	4	2	3 1/2	3	1 3/4
2 1/2		12.00	4		4 1/2	5	2 3/4

## Thru Hull CONNECTIONS

For Hose  
CAST BRONZE—BURNISHED

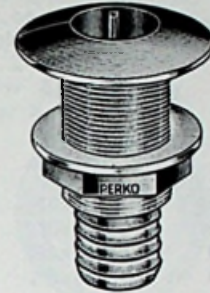

Fig. 350

For Hose Inches	Each	Length Overall Inches	Maximum Wood Thickness Inches	Weight Pounds
5/8	\$2.60	3	1 1/4	3/8
3/4	3.40	3 3/8	1 3/8	1/2
1	5.00	3 3/8	1 3/8	3/8
1 1/4	6.15	4 1/4	2	1 3/8
1 1/2	6.45	4 1/4	2	1 1/2

## Thru Hull CONNECTIONS

For Hose

CAST BRONZE—BURNISHED

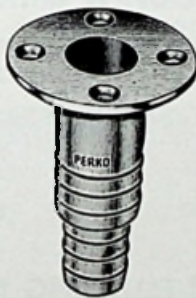

Fig. 311

This useful fitting is generally used above the water-line. It accommodates two sizes of hose.

Each	For Size Hose Inches	Inside Diameter Inches	Length Overall Inches	Weight Ounces
\$2.00	3/4 and 1	3/8	3 3/8	7

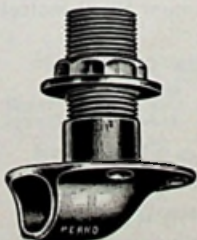

Fig. 332

## Water OUTLETS

CAST BRONZE

Pipe Size Inches	Diam. Flange Inches	Length of Pipe Inches	Weight
3/4	2 3/4	2 1/4	12 oz.

Burnished Bronze Each	Chromium Plated Each
\$5.00	\$7.00

## New Speedboat STRAINERS

For Hose

CAST BRONZE—BURNISHED

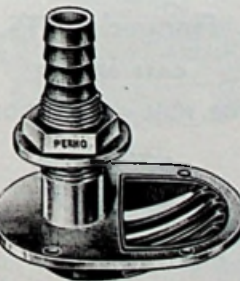

Fig. 102

For Hose Inches	Each	Length Neck Inches	Maximum Wood Thickness Inches	Dimensions Strainer Inches	Weight Pounds
3/8	\$4.70	2 3/4	1 3/8	2 1/2 x 3 1/2	3/8
3/4	5.55	2 3/4	1 1/2	3 x 4	1 1/8

## Speedboat STRAINERS

CAST BRONZE—BURNISHED

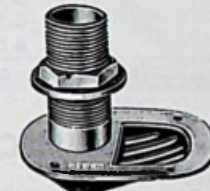

Fig. 65

Designed to prevent clogging. Will admit full supply of water at all speeds.

Size Pipe Inches	Each	Length Pipe Inches	Dimensions Strainer Inches	Weight Pounds
1/2	\$4.20	2 1/4	2 1/2 x 3 1/2	5/8
3/4	5.05	2 3/8	3 x 4	3/8
1	6.25	3	3 3/8 x 4 1/4	1 1/8
1 1/4	9.35	3 3/8	3 3/8 x 4 1/2	1 3/4



## Scoop STRAINERS

CAST BRONZE—BURNISHED



Fig. 66

Can be used with inlet connection, Fig. 64. No. 1 will fit up to 1/2 inch. No. 2 will fit up to 1 inch. No. 3 will fit up to 1 1/4 inches. No. 4 up to 2 inches.

No.	Each	Outside Dimension Inches	Weight Each
1	\$1.05	3 1/2 x 2 1/2	4 oz.
2	1.55	5 x 3 1/4	7 oz.
3	3.00	6 1/4 x 4 1/4	1 lb.
4	5.70	8 1/4 x 5 1/4	2 lbs.

## Brass AXE BRACKETS

18 GAUGE—POLISHED



Fig. 325

A set consists of one blade socket and one handle bracket as illustrated.

Complete Sets Per Dozen	Blade Sockets Only Per Dozen	Handle Brackets Only Per Dozen	For Blade Width Inches	Weight Per Set Ounces
\$33.60	\$21.00	\$12.60	6	8

## Round STRAINERS

CAST BRONZE—BURNISHED



Fig. 86

Outside Diam. Inches	Each	Inside Diam. Inches	Weight Each
2 1/2	\$ .80	1 3/4	2 oz.
3	.90	2	4 oz.
3 1/2	1.30	2 5/8	5 oz.
4 1/2	1.75	3	6 oz.
5	2.65	3 3/4	12 oz.
6	3.40	4 1/2	1 lb.
8	5.25	6	2 lbs.
10	8.00	8 1/4	3 lbs.

## Sword Fish DARTS

CAST BRONZE POINT GROUND AND SHARPENED

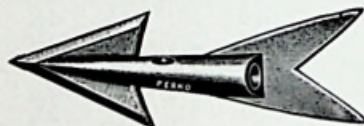

Fig. 805

Burnished Each	Length Inches	Weight Ounces	Packed Per Box
\$1.10	5	5	12

## Bronze TAIL PIECES

For lead pipe or hose connections, furnished complete with rubber washer.



Fig. 67 Straight  
Fig. 78,  
90 Degree

Pipe Size Inches	O.D. Tail Piece Inches	Fig. 67 Each	Fig. 78 Each
1/4	3/8	\$ .90	
3/8	1/2	.90	
1/2	1/2	1.15	
3/4	3/4	1.40	\$1.80
1	1	2.00	3.10
1 1/4	1 1/4	2.35	3.35
1 1/2	1 1/2	3.50	4.25
2	2	4.80	6.05

## DART SHANKS

IRON SHANK—CAST BRONZE SOCKET

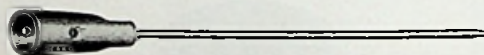

Fig. 655

Length overall, 24 inches; Weight, 1 1/4 pounds.

Complete Each	Shank Only Each
\$4.00	\$1.00

## Outboard FLUSHING NOZZLES

ALUMINUM AND BRASS FOR INTERNAL FLUSHING OF LOWER UNIT IN OUTBOARD MOTOR

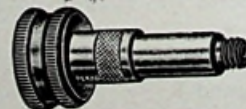

Fig. 179

The male threaded end is for attachment to all motors having flush plugs.

The female threaded end is for regular garden hose.

No.	Each	Size Thread	Length Overall Inches	Weight Ounces
2	\$1.00	3/8" x 16	2 3/4	2
3	1.00	1/8" Pipe	2	1 1/2
4	1.00	3/16" x 20	2 7/8	2

No. 2 for Evinrude 15 H.P., Johnson 10 H.P.

No. 3 for Evinrude 7 1/2 H.P. and others.

No. 4 for Evinrude and Johnson 3 H.P. and others.

## Flanged NUTS

CAST BRONZE

FOR HULL CONNECTIONS



Fig. 75

Pipe Size Inches	Each	Weight Ounces	Pipe Size Inches	Each	Weight Ounces
3/8	\$ .45	1	1 1/4	\$1.30	6
1/2	.50	1 1/4	1 1/2	1.55	6
3/4	.65	2	2	2.15	10
1	.80	2 1/2	2 1/2	3.40	15





## Marine WINDOWS WITH SPIGOT PLAIN BRONZE OR ALUMINUM WATERTIGHT—TWO FASTENINGS

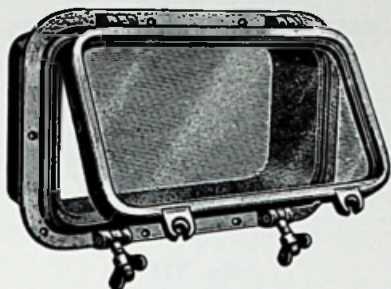

Fig. 796

Furnished complete with removable screen and outside finishing frame.

Designed to supply the maximum amount of air and light possible while keeping bulk and weight to a minimum.

No.	Size of Opening Inches	Plain Bronze Each	Plain Aluminum Each	Without Finishing Frame Deduct	
				Bronze Each	Aluminum Each
1	5x12	\$36.60	\$28.65	\$2.70	\$1.80
2	7x16	50.70	35.50	3.40	2.15

No.	Dimensions Outside of Frame Inches	Length Spigot Inches	Thickness Glass Inches	Bronze Weight Pounds	Aluminum Weight Pounds
1	7 $\frac{1}{4}$ x14 $\frac{3}{4}$	2	$\frac{1}{4}$	16	7
2	10 x19 $\frac{1}{4}$	2	$\frac{1}{4}$	22	10

## Marine WINDOWS WITHOUT SPIGOT PLAIN BRONZE OR ALUMINUM WATERTIGHT—TWO FASTENINGS

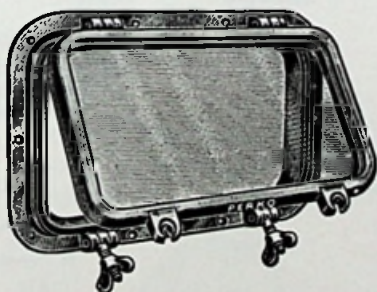

Fig. 803

Furnished complete with removable screen. Without finishing frame.

No.	Size of Opening Inches	Plain Bronze Each	Plain Aluminum Each	Bronze Weight Pounds	Aluminum Weight Pounds
3	5x12	\$29.00	\$24.00	11 $\frac{1}{2}$	5
4	7x16	37.00	29.00	16	7

### SPECIAL FINISHING FRAMES FOR FIG. 803

3	5x12	\$ 6.00	\$ 5.50	2 $\frac{1}{2}$	1
4	7x16	7.50	7.00	3 $\frac{1}{2}$	1 $\frac{1}{2}$

**NOTE**—These Special Finishing Frames have mounting holes drilled to line up with those in window frame.

For other dimensions, see Fig. 796 above.

**NOTE**—Spare Screens for Figs. 796 and 803, size 5x12 inches—\$5.50 each. Size 7x16 inches—\$6.25 each.

## New Fixed WINDOWS ANODIZED ALUMINUM FRAME—POLISHED $\frac{3}{16}$ INCH PLEXIGLASS WINDOW

These are non-opening, designed for permanent attachment, frame is grooved for sealing compound, glass set in vinyl for watertight fit. Frame drilled for No. 6 F.H. screws.

### ROUND TYPE



Fig. 806

Diameter Window Inches	Each	Outside Diam. Frame Inches	Weight Pounds
5	\$5.50	7 $\frac{1}{8}$	$\frac{1}{2}$
6	5.75	8 $\frac{1}{8}$	$\frac{5}{8}$
7	6.00	9 $\frac{1}{8}$	$\frac{3}{4}$
8	6.50	10 $\frac{1}{8}$	1

### RECTANGULAR TYPE



Fig. 807

Size Window Inches	Each	Dimensions Outside of Frame Inches	Weight Pounds
5x12	\$13.50	7 $\frac{1}{8}$ x14 $\frac{1}{8}$	1 $\frac{1}{4}$
7x16	17.50	9 $\frac{1}{8}$ x18 $\frac{1}{8}$	1 $\frac{3}{4}$

## Oval Inside PORTLIGHTS PLAIN BRONZE OR ALUMINUM WITH OUTSIDE FINISHING RING AND REMOVABLE HINGE PIN

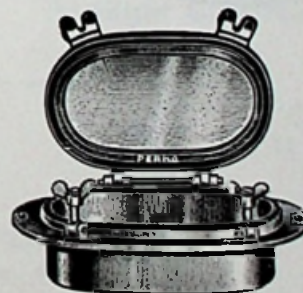

Fig. 897

Size of Opening Inches	Bronze For Wood Thickness 1 $\frac{1}{2}$ Inches	Aluminum For Wood Thickness 1 $\frac{1}{2}$ Inches	Without Finishing Ring Deduct	
			Bronze Each	Aluminum Each
4x5	\$24.70	\$18.70	\$ 2.00	\$ 1.50
5x9	31.60	23.20	2.85	2.20

Size of Opening Inches	Length Flange Inches	Width Flange Inches	Thickness Glass Inches	Bronze Weight Pounds	Aluminum Weight Pounds
4x7	10	7	$\frac{3}{8}$	8 $\frac{1}{2}$	4 $\frac{1}{4}$
5x9	12	8	$\frac{3}{8}$	11 $\frac{1}{4}$	6

**NOTE**—Screens for above, see Fig. 443.



## Round PORTLIGHTS

CAST BRONZE

GLASS AREA IS SAME DIAMETER AS OPENING

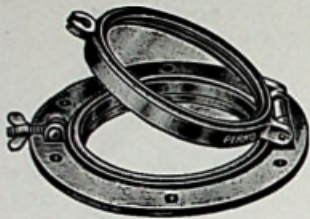

Fig. 317

Diam. Opening Inches	Plain Bronze Each	Diam. Clear Glass Inches	Outside Diam. Frame Inches	Thickness Glass Inches	Weight Pounds
4	\$12.20	4	7 $\frac{3}{8}$	$\frac{1}{4}$	2 $\frac{3}{4}$
5	15.20	5	8 $\frac{3}{4}$	$\frac{1}{4}$	4 $\frac{3}{8}$
6	17.65	6	9 $\frac{3}{4}$	$\frac{1}{4}$	5 $\frac{3}{8}$
7	25.00	7	10 $\frac{3}{8}$	$\frac{3}{8}$	8
8	28.30	8	12 $\frac{1}{4}$	$\frac{3}{8}$	9 $\frac{1}{2}$

All sizes have Removable Hinge Pin.

## DECK LIGHTS

CAST BRONZE—FOR WOOD DECKS



Fig. 838

Diameter Clear Glass Inches	Plain Bronze Each	Polished Bronze Each	Thickness Glass Inches	Outside Diam. Frame Inches	Weight Pounds
4	\$ 6.10	\$ 9.60	$\frac{1}{4}$	6 $\frac{1}{2}$	2
5	9.80	13.75	$\frac{3}{8}$	7 $\frac{1}{2}$	3 $\frac{3}{8}$
6	12.20	16.75	$\frac{3}{8}$	8 $\frac{1}{2}$	3 $\frac{3}{8}$
8	20.90	25.90	$\frac{1}{2}$	11	7 $\frac{1}{4}$

## More-Air PORTLIGHTS

INSIDE PATTERN—FOR WOOD HULLS

CAST BRONZE—PLAIN

COMPLETE WITH OUTSIDE FINISHING RING

GLASS AREA IS SAME DIAMETER AS OPENING

ALL SIZES ARE GROOVED FOR SCREENS

WITH REMOVABLE HINGE PIN

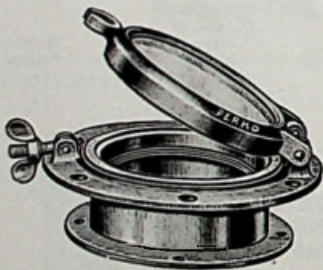
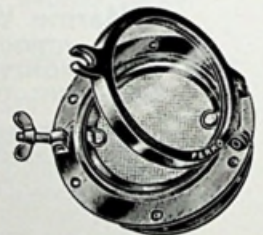

Fig. 157

Showing Screen in Place



Opening Inches	For Thickness of Wood		Outside Diameter Frame Inches	Thickness Glass Inches	Weight 1 $\frac{1}{2}$ Inch Spigot In Pounds
	1 $\frac{1}{2}$ Inch Plain Bronze Each	3 Inch Plain Bronze Each			
4	\$13.00	\$14.75	6 $\frac{3}{8}$	$\frac{1}{4}$	4 $\frac{1}{2}$
5	14.75	17.75	7 $\frac{1}{4}$	$\frac{1}{4}$	6
6	19.00	21.90	8 $\frac{3}{8}$	$\frac{1}{4}$	7 $\frac{3}{4}$
7	25.50	30.40	10 $\frac{1}{8}$	$\frac{3}{8}$	11
8	29.75	34.00	11 $\frac{1}{2}$	$\frac{3}{8}$	14 $\frac{1}{2}$

For 1 inch wood, use 1 $\frac{1}{2}$  inch price. For 2 or 2 $\frac{1}{2}$  inch wood use 3 inch price, etc.

Without outside finishing ring, deduct from above prices the following:

	4 Inch	5 Inch	6 Inch	7 Inch	8 Inch
Plain	\$1.15	\$1.30	\$1.60	\$2.70	\$3.10

NOTE—Screens for all portlights above see Fig. 442.

Stock size is for 1 $\frac{1}{2}$  inch wood, other sizes made to order only.



**Round Portlight SCREENS**  
BRONZE-SPRING TYPE  
FOR FIGS. 157 AND 317 PORTLIGHTS



Fig. 442

For Size Opening Inches	Bronze Each	Dull Chromium Plated Each	For Size Opening Inches	Bronze Each	Dull Chromium Plated Each
4	\$2.65	\$3.65	7	\$3.95	\$5.00
5	3.00	4.00	8	4.35	5.35
6	3.35	4.35			

**Glass Run WINDOW CHANNEL**

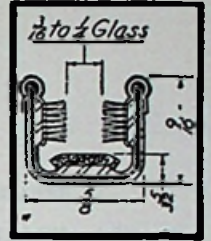
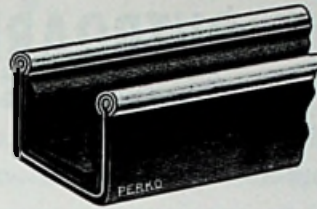

**STANDARD TYPE FIG. 482**

Vulcanized rubber covered, mohair lined, No. 400 series stainless steel bead.

Per 8 Foot Length \$5.30

**MARINE TYPE FIG. 479**

Wool felt pile with vinyl strip for smoother operation of glass. No. 302 stainless steel bead.

Per 8 Foot Length \$8.90

Weight per length 1 pound

**Oval Portlight SCREENS**  
BRONZE-SPRING TYPE  
FOR FIG. 897 PORTLIGHT



Fig. 443

For Size Opening Inches	Bronze Each	Dull Chromium Plated Each
4x7	\$3.85	\$4.85
5x9	4.50	5.50

**SLIDING WINDOW HANDLE**  
BRASS-CHROMIUM PLATED

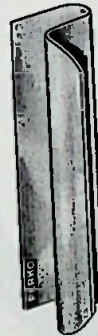

Fig. 954

For 1/4 inch glass.

A useful handle made for easier operation of sliding windows.

Each	Length Inches	Weight Ounces
1.35	3	1

**Round Portlight SCREENS**  
BRASS FRAME-COPPER SCREENING  
FRICTION TYPE-FOR RECESSED PORTLIGHTS



Fig. 434

Outside Diameter Inches	For Size Portlight Inches	Each	Outside Diameter Inches	For Size Portlight Inches	Each
4 1/16	4	\$2.75	8 1/16	8	\$4.60
5 1/16	5	3.15	9 1/16	9	4.80
6 1/16	6	3.45	10 1/16	10	6.00
7 1/16	7	4.20	12 1/16	12	6.85

Larger sizes made to order-Price on application.

**Portlight CHAINS**  
BRONZE



Fig. 441

Length Inches	Polished Each	Chromium Plated Each	Size Plate Inches	Weight Ounces
8	\$2.00	\$2.85	1 1/4 x 1	3

**RUBBER for Portlights**



Fig. 461

Size	Per Length
1/4 inch square	\$1.95
3/8 inch square	2.95
1/2 inch square	4.00

Supplied only in 12 1/2 foot lengths

## IMPROVED OUTBOARD STEERERS

FOR THRU-DASHBOARD OR UNDER DASHBOARD MOUNTING

MADE IN ACCORDANCE WITH O.B.C. STANDARDS MANUAL, 1960 EDITION

BRILLIANT COLORS — MODERN STYLING — CHROMIUM PLATED HOUSING — NYLON BEARINGS

A VERY ATTRACTIVE WHEEL OF MODERN DEEP DISH, 2-SPOKE DESIGN WITH MOULDED FINGER GRIPS FOR EASE OF HANDLING.

HOUSING IS PERFECTLY ENGINEERED, HIGH GRADE PRECISION DIE CASTING, POLISHED AND CHROMIUM PLATED. BEARINGS ARE NYLON, ASSURING SMOOTH OPERATION.

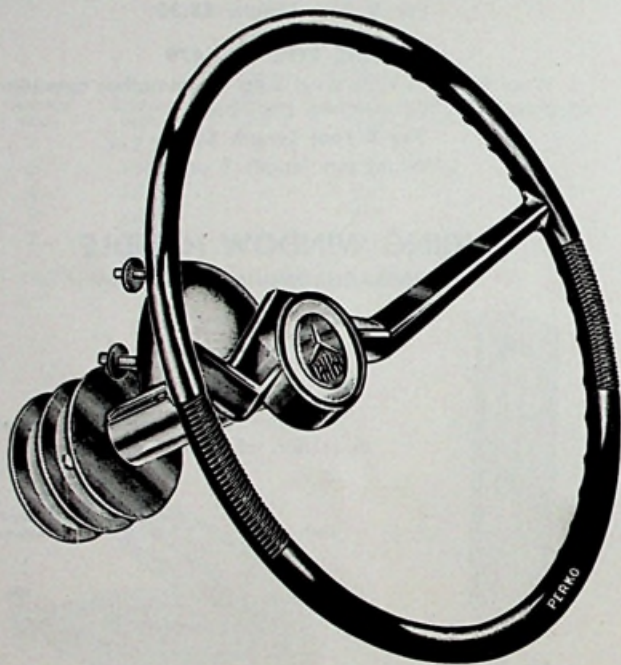

SOLID COLORS  
 IVORY  
 RED  
 GREEN  
 EVINRUDE BLUE

each, \$15.95  
 As Illustrated

TWO TONE COLORS  
 IVORY and RED  
 IVORY and BLUE  
 IVORY and CHARCOAL  
 IVORY and GREEN

each, \$16.95  
 See Note Below

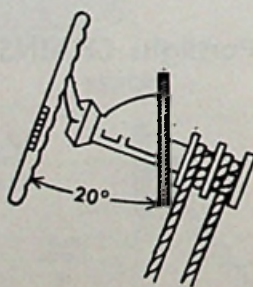

FIG. 1270

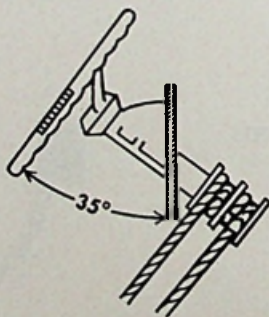
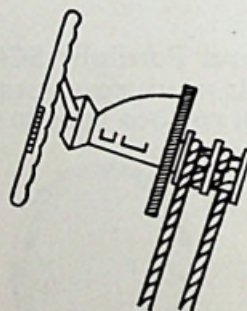

FIG. 1271



FOR ANGLE DASH  
 FIG. 1272

Outside Diameter Wheel Inches	Length Overall Inches	Length Dash To Grip of Wheel Inches	Diameter Score of Drum Inches	Diameter Overall of Drum Inches	Weight Pounds
15	12 $\frac{5}{8}$	7 $\frac{1}{2}$	2 $\frac{1}{2}$	3 $\frac{3}{4}$	7 $\frac{1}{4}$

NOTE—All two tone wheels have hub medallion illustrated on Fig. 1200 Page 101. A solid ivory wheel with Fig. 1200 medallion is available with above steerer, complete each, \$16.50.

Special colors or color combinations can be supplied in quantity. Details on application.



# "FLYING P" OUTBOARD STEERERS

MADE IN ACCORDANCE WITH O.B.C. STANDARDS MANUAL 1960 EDITION

MODERN DEEP DISH 2-SPOKE 15 INCH WHEEL IN SOLID OR TWO TONE COLORS

PRECISION DIE CAST HOUSING AND DRUM—NYLON BEARINGS

DASHBOARD HOUSING IS POLISHED CHROMIUM PLATED

TWO TONE COLORS ARE—IVORY AND RED—IVORY AND BLUE—IVORY AND CHARCOAL—IVORY AND GREEN

## DE LUXE MODEL

FOR THRU-DASHBOARD MOUNTING

ANGLE ADJUSTABLE FROM 0 TO 35 DEGREES

WITH SOLID IVORY COLORED WHEEL, EACH \$18.50

WITH TWO TONE COLORED WHEEL, EACH \$18.95

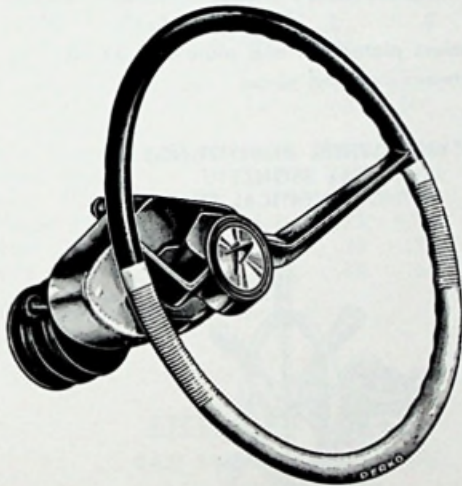

Fig. 1200

Overall Inches Length	Length Dash To Grip of Wheel Inches	Width Housing Inches	Height Housing Inches	Diameter Score of Drum Inches	Diameter Overall of Drum Inches	Weight Pounds
12 $\frac{3}{4}$	7 $\frac{1}{2}$	8 $\frac{1}{2}$	4 $\frac{1}{4}$	2 $\frac{1}{2}$	3 $\frac{3}{4}$	8 $\frac{1}{2}$

## STANDARD MODEL

FOR THRU-DASHBOARD MOUNTING

FIXED ANGLE—NOT ADJUSTABLE

WITH SOLID IVORY COLORED WHEEL, EACH \$14.50

WITH TWO TONE COLORED WHEEL, EACH 14.95

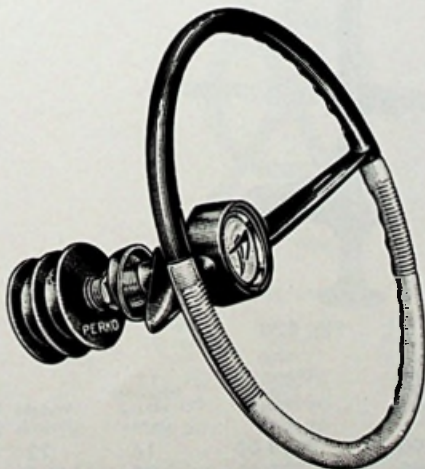

Fig. 1257 with 20 degree angle

Fig. 1257-A with 35 degree angle

Fig. 1257-B with 90 degree angle

Length Overall Inches	Length Dash to Grip of Wheel Inches	Width Dash Bracket Inches	Height Dash Bracket Inches	Diameter Score of Drum Inches	Diameter Overall of Drum Inches	Weight Pounds
11 $\frac{1}{2}$	6	5	2 $\frac{3}{4}$	2 $\frac{1}{2}$	3 $\frac{3}{4}$	7

NOTE—No bolts or screws necessary to install this steerer. Just drill a 1 $\frac{1}{4}$  inch diameter hole in dash. Steerer held firm by angle washer and large locknut.

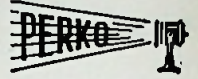

**Chain Type STEERERS**  
ALL BRONZE—WITH ROLLER CHAIN  
FOR WHEEL BOX MOUNTING

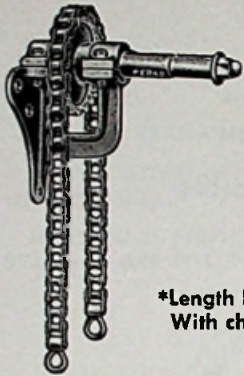

No.	Wheel End of Shaft Inches	Each
1	3/8	\$50.00
2	1	50.00

*Length Shaft Inches	Dimensions of Bracket Inches	Weight Pounds
2 3/8	6 x 5 1/2	11

\*Length between bracket and wheel.  
With chromium plated nut add \$.75 each.

Fig. 678

Chain only, without Shackles, per foot	\$5.50
Chain Shackles, each	1.00
Acorn Nuts, each	2.00
Sprocket only, each	6.00

Sprocket, 4 3/8 inch diameter, 21 teeth.  
Chain, 36 inches long, 5/8 inch pitch.  
Shaft machined for hub 2 1/8 inches thick.

Wheels for above see Figs. 657, 914 and 976, Sizes 4, 5 and 6.

Special machining of shaft, on application.  
Supplied with reversed shaft for thru-bulkhead mounting at above prices, please specify.

**Chain Type STEERERS**  
WITH FIG. 976 CAST BRONZE WHEEL  
POLISHED OR CHROMIUM PLATED

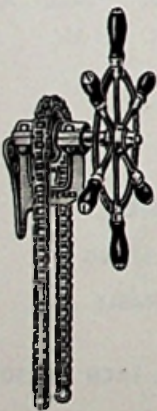

Fig. 674

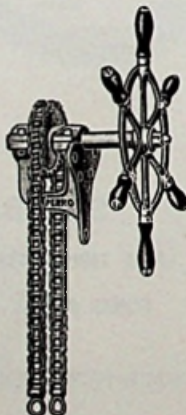

Fig. 675

Diameter Wheel Inches	Polished Bronze Each	Chromium Plated Each	Machined Wheel End of Shaft Inches	Diam. Shaft Inches
16	\$68.75	\$74.75	3/8	1
20	77.00	85.00	3/8	1
24	84.00	103.00	1	1

Wheel, shaft and nut only are polished or plated, balance of steerer is plain bronze.

NOTE—Both of the above steerers can be supplied with Fig. 914 wheel. For price, add the difference between Figs. 976 and 914, sizes No. 1, 2 or 3.

**Universal Worm Geared STEERER**  
CAST BRONZE HOUSING—ALL BRONZE GEARS

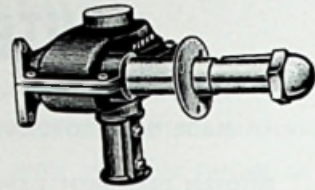

Fig. 524

A completely universal steerer in all respects. Can be operated either right or left hand and wheel shaft may be quickly and easily reversed for wheel box or thru-bulkhead mounting.

For rudder of 4 square foot area.

For 1 inch diameter vertical shaft.

Each	Diam. Wheel Shaft Inches	*Length Wheel Shaft Inches	Length For Hub Inches	Size Bracket Overall Inches	Weight Pounds
\$75.00	1	3	2 3/8	5 x 2 3/4	7 1/2

With Chromium plated nut and plate add \$1.00.

\*Length between box and wheel.

**WITH WHEEL AND FITTINGS**  
ALL BRONZE  
WITHOUT VERTICAL SHAFT

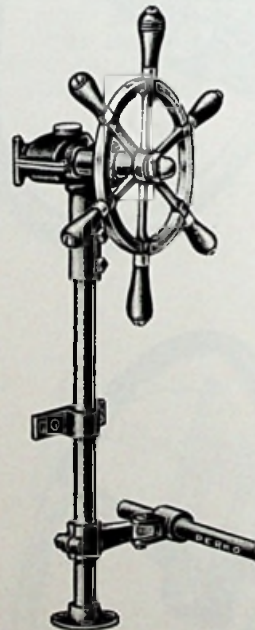

Fig. 820

No.	With Polished Bronze Wheel Each	With Chromium Plated Wheel Each	Diameter Wheel Inches	Weight Pounds
1	\$121.00	\$128.00	16	22
2	128.50	137.50	20	25
3	147.00	157.00	24	29

Wheel used is Fig. 976 sizes 4, 5 or 6.

If preferred with wheel Figs. 657 or 914 add difference in price of wheel only.

Other spare parts see Fig. 865 Part Nos. 1, 5, 6 & 8.



## Drum STEERERS

GALVANIZED CAST IRON OR CAST BRONZE FOR TILLER ROPE



Fig. 661

Diam. Overall Inches	Galv. Each	Polished Bronze Each	Chromium Plated Each	Size Base Inches	Diam. Drum Inches	Length Drum Inches
12	\$ 9.55	\$19.50	\$21.00	3 $\frac{3}{8}$ x 3 $\frac{3}{8}$	2 $\frac{3}{8}$	3
16	12.25	26.25	28.25	4 x 4	2 $\frac{3}{8}$	3 $\frac{3}{8}$
20	21.90	38.80	43.00	5 $\frac{1}{8}$ x 5 $\frac{1}{8}$	3 $\frac{3}{8}$	4 $\frac{1}{4}$

### SPARE PARTS

	12 inch		16 inch		20 inch	
	Galv. Each	Bronze Each	Galv. Each	Bronze Each	Galv. Each	Bronze Each
Posts with Back Plates	\$1.80	\$4.20	\$3.00	\$4.20	\$5.20	\$7.50
Wood Drums	.90	.90	1.60	1.60	5.00	5.00
Acorn Nuts	.50	.75	.50	1.35	.50	1.90
*Wheel Only	4.00	5.75	5.75	9.25	8.50	12.50
Grips Only	.30	.30	.35	.35	.45	.45
Bolts Only	.30	.55	.40	.65	.40	.80

\*Does not include handles or bolts.

## STEERING WHEELS

CAST BRONZE—WOOD GRIPS  
1/4 INCH KEYWAY

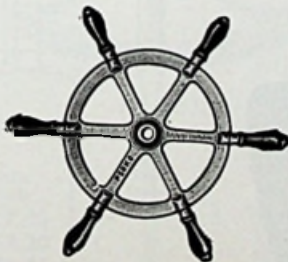

Fig. 976

With Short Hub for Steerers Figs. 674 and 675

No.	Diam. Overall Inches	Polished Bronze Each	Chromium Plated Each	For Shaft Inches	Length Hub Inches	Weight Pounds
1	16	\$18.75	\$24.75	7/8	1	4
2	20	27.00	35.00	7/8	1	6 $\frac{1}{4}$
3	24	44.00	53.00	1	1 $\frac{1}{4}$	10 $\frac{3}{4}$

With Long Hub for Steerers Figs. 524 and 678

No.	Diam. Overall Inches	Polished Bronze Each	Chromium Plated Each	For Shaft Inches	Length Hub Inches	Wt. Lbs.
4	16	\$23.00	\$29.00	3/4, 7/8 or 1	2 $\frac{1}{8}$	4 $\frac{1}{4}$
5	20	31.50	39.50	3/4, 7/8 or 1	2 $\frac{1}{4}$	7 $\frac{1}{4}$
6	24	49.00	58.00	1	2 $\frac{1}{8}$	11

## New Cruiser STEERERS

SPOKE TYPE FOR TILLER ROPE

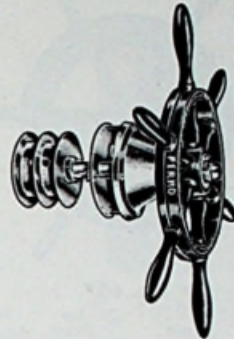

Fig. 690 with Bronze Chromium Plated Wheel

Fig. 695 with Tenite Wheel — 4 Colors

An excellent nautical type steerer for small outboard cruisers, pontoon boats etc.

The tenite wheel is polished, has steel core and hub, colors are white, black, red and mahogany.

Fig.	Diameter Overall Wheel Inches	Each	Diameter Bulkhead Bracket Inches	Length Overall Inches	Weight Pounds
690	12	\$27.50	4 $\frac{3}{4}$	9 $\frac{1}{2}$	5 $\frac{1}{8}$
690	16	33.50	4 $\frac{3}{4}$	9 $\frac{1}{2}$	7 $\frac{1}{8}$
695	16	30.00	4 $\frac{3}{4}$	9 $\frac{3}{4}$	5 $\frac{3}{4}$

Specify color of tenite wheel.

## STEERING WHEELS

BRASS—WOOD GRIPS—ROUND SPOKES  
1/4 INCH KEYWAY

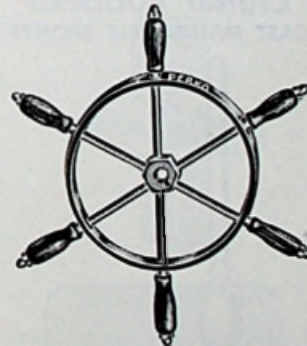

Fig. 914

With Short Hub for Steerers Figs. 674 and 675

No.	Diam. Overall Inches	Polished Brass Each	Chromium Plated Each	For Shaft Inches	Length Hub Inches	Weight Pounds
1	16	\$26.50	\$32.00	7/8	1	4 $\frac{1}{4}$
2	20	31.00	37.50	7/8	1	5 $\frac{1}{4}$
3	24	38.00	46.50	1	1 $\frac{1}{4}$	6 $\frac{3}{4}$

With Long Hub for Steerers Figs. 524 and 678

No.	Diam. Overall Inches	Polished Brass Each	Chromium Plated Each	For Shaft Inches	Length Hub Inches	Wt. Lbs.
4	16	\$29.50	\$35.75	3/4, 7/8 or 1	2 $\frac{1}{8}$	4 $\frac{1}{4}$
5	20	36.50	43.00	3/4, 7/8 or 1	2 $\frac{1}{8}$	6 $\frac{1}{4}$
6	24	44.00	52.50	1	2 $\frac{1}{8}$	7



## Mahogany STEERING WHEELS WITH PLUGGED OR INLAID RIM CAST BRONZE HUB—POLISHED

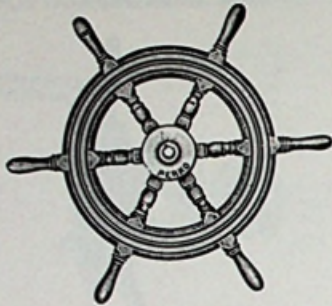

Fig. 657

Diam. Overall Inches	Plugged Each	Inlaid Each	For Shaft Inches	Size Keyway Inches	Thickness of Hub Inches	No. of Spokes
*18	\$44.25	\$50.00	3/8 or 1	1/4	2 1/8	6
*20	47.50	55.00	3/8 or 1	1/4	2 1/8	6
*24	55.50	61.00	1	1/4	2 1/8	6
28	71.50	78.00	1	3/8	2 1/8	6
30	79.50	86.00	1	3/8	2 1/4	8
32	98.00	103.50	1 1/4	3/8	2 1/4	8
36	125.00	137.00	1 1/4	3/8	2 1/2	8
42	143.50	156.50	1 1/4	3/8	2 1/2	8
48	160.00	174.00	1 3/8	3/8	3	8
54	198.00	212.50	1 3/8	3/8	3	8
60	225.50	240.00	1 3/8	3/8	3	10

\*These sizes with chromium plated hub carried in stock, add \$6.00 each.

Larger sizes with chromium plated hub made to order only, add \$7.50 each.

NOTE—Shaft sizes above are stock bores, special boring supplied to order, price on application.

Wheel with inlaid hub supplied unless otherwise specified.

## Cruiser RUDDERS CAST MANGANESE BRONZE

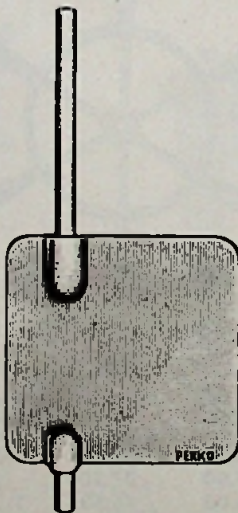

Fig. 816

No.	Blade Size Inches	Each	Blade Thickness Inches	Diam. of Stock Inches	Total Length of Stock Inches	Longer Stocks Per Inch	Weight Pounds
1	12x12	\$51.75	1/4	1	12	\$.55	15
2	13x13	56.25	1/4	1	12	.55	16

## Speed Boat RUDDERS CAST MANGANESE BRONZE

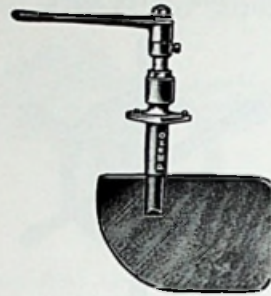

Fig. 813

Furnished complete with tiller, collar, nut, rudder port and machined stock. Standard length stock above blade 12 inches.

No.	Complete Each	Rudder Only Each	Blade Size Inches	Diam. Stock Inches	Length Tiller Inches	Weight Rudder Only Pounds
1	\$71.75	\$36.75	9x14	1	12	12

With stock longer than standard, price on application.

"Rudder Only" supplied without machined stock. With machined stock, price on application.

## Hyspeed RUDDERS CAST MANGANESE BRONZE

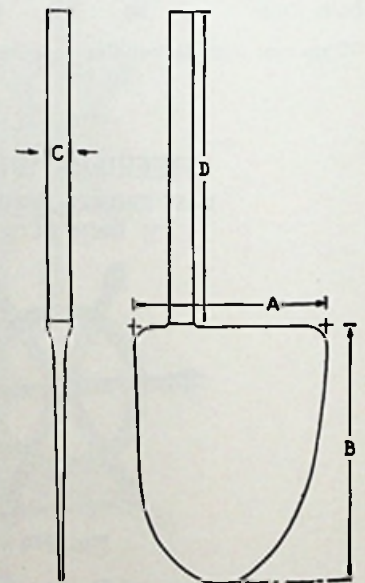
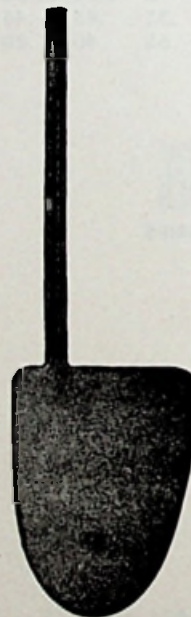

Fig. 818

Constructed in perfectly balanced proportion. Designed for express cruisers, runabouts, speedboats and all boats not carrying a skag.

No.	Each	Dimension Inches				Weight Pounds
		A	B	C	D	
1	\$44.00	9	12	1	16	12
2	54.00	10 1/2	14	1 1/4	18	17
3	59.50	12	16	1 1/4	18	20

With stock longer than standard, price on application.

NOTE—Orders for rudders with special length of stock cannot be cancelled. Delivery about 30 days.





**Bronze Rudder COLLARS**



Fig. 815

For Diam. Stock Inches	Each	Outside Diameter Inches	Thickness Inches	Weight Ounces
3/4	\$2.00	1 1/8	1 3/8	2 1/4
7/8	2.60	1 1/4	7/8	4
1	2.75	1 3/4	1 1/8	7
1 1/8	2.75	1 3/4	1 3/8	6 1/2
1 1/4	3.95	2 1/8	1 3/8	11
1 3/8	4.90	2 1/2	1 1/8	19
1 1/2	5.20	2 1/2	1 1/8	19

**Bronze TILLERS**

CAST BRONZE



Fig. 810

For round stock rudders Figs. 813, 816, 818.

No.	Each	Length Inches	For Rudder Stock Inches	Size Keyway Inches	Weight Pounds
1	\$ 7.35	8	3/4 or 1	3/8 or 1/4	1 1/2
2	8.70	10	1	1/4	2
3	10.00	12	1	1/4	3 1/4

NOTE—Size No. 1, please specify size of rudder stock.

**Quadrant TILLERS**

GALVANIZED MALLEABLE IRON



Fig. 651

Radius Inches	Galv. Each	Max. Diam. Rope Inches	Square Hole Adjustable Inches	Weight Pounds
7	\$ 7.35	3/8	3/8 to 3/4	3
10	17.20	3/8	3/8 to 1	5 1/4
12	21.75	3/8	3/4 to 1 1/4	8 1/2

**Rudder SKAGS**

CAST BRONZE—PLAIN

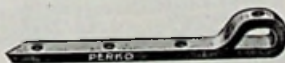

Fig. 649

Size No.	Each	Dimensions Inches	For Rudder Post Inches	Weight Pounds
0	\$10.25	24x1 1/2x3/8	3/4	4 1/2
1	16.25	30x1 3/4x1/2	3/4	9
2	30.50	42x2 x3/8	1	17

**RUDDER STUFFING BOXES**

CAST BRONZE—PLAIN

WITH SQUARE FLANGE—FOUR BOLT HOLES

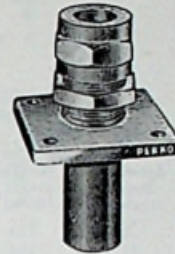

Fig. 1088

A stuffing box to prevent leakage to rudder post entrance and a long bronze rudder post bearing to assure smooth rudder operation.

For Diam. Post Inches	Each	Size Flange Inches	Length Bearing Inches	Drilled For Fastening Inches	Weight Pounds
1	\$13.25	3 3/4 x 3 3/4	5 1/4	3/8	3
1 1/8	15.00	3 3/4 x 3 3/4	5 3/8	3/8	3 1/2
1 1/4	16.50	3 3/4 x 3 3/4	6 1/4	3/8	4

**RUDDER STUFFING BOXES**

CAST BRONZE—PLAIN

WITH OVAL FLANGE—TWO BOLT HOLES

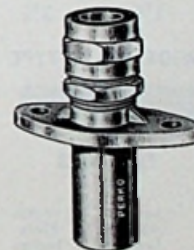

Fig. 1089

Eliminates leakage at rudder post entrance through the hull.

Bronze bearing is full length of casting. Assures smooth action with minimum wear.

Size Inches	Each	Size Flange Inches	Length Bearing Inches	Drilled for Fastening Inches	Weight Pounds
3/4	\$11.50	4 x 2	5 1/8	5/8	3
3/8	12.00	4 1/4 x 2 1/4	5 3/8	3/8	3 1/4
1	12.00	4 1/4 x 2 1/4	5 3/8	3/8	3 1/4
1 1/8	13.75	5 x 2 3/8	5 1/2	1/2	3 3/4
1 1/4	18.25	5 3/4 x 3	6 3/8	1/2	5 1/2
1 3/8	19.25	6 1/4 x 3 1/4	6 3/4	1/2	6 1/2
1 1/2	21.00	6 1/2 x 3 1/2	6 3/4	1/2	6 3/4



## Rudder Brace PINTLES CAST BRONZE

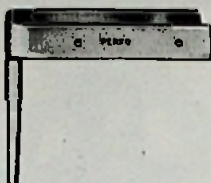

Fig. 1071

Size No.	Burnished Each	Between Straps Inches	Length Straps Inches	Width Straps Inches	Weight Ounces
00	\$ .95	5/8	2 7/8	3/4	8
0	1.25	3/4	3 1/2	7/8	9
1	1.60	7/8	4 1/4	7/8	10
2	2.25	1	4 1/2	1	11
3	2.85	1 1/4	4 3/4	1	13
4	4.90	1 1/2	5 1/2	1 1/4	22

Sizes No. 00 to No. 1 inclusive have machined straight shank. Larger sizes have tapered shank.

## Rudder Brace GUDGEONS CAST BRONZE STRAP TYPE



Fig. 1070

Size No.	Burnished Each	Between Straps Inches	Length Straps Inches	I. D. Hole Minimum Inches	Weight Ounces
00	\$ .80	5/8	2	1/2	4
0	1.10	3/4	2 1/2	1/2	5
1	1.50	7/8	3	1/2	6 1/2
2	2.15	1	3	5/8	7
3	2.30	1 1/4	3 1/4	5/8	8
4	3.75	1 1/2	3 3/4	3/4	15

### WIDE PLATE TYPE



Fig. 1073

Size No.	Burnished Each	Length Plate Inches	Width Plate Inches	I. D. Hole Minimum Inches	Weight Ounces
00	\$ .85	3 1/2	3/4	1/2	3
0	.90	3 1/2	3/8	1/2	3
1	1.10	3 3/8	3/8	1/2	4
2	1.50	4 1/8	1	5/8	6
3	1.80	4 3/8	1 1/8	5/8	8
4	1.90	4 3/8	1 1/4	1 1/8	9

## Aluminum RACING FIN CAST ALUMINUM

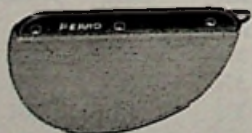

Fig. 189

Length Overall Inches	Depth Blade Inches	Size Flange Inches	Weight Lbs.
9 1/4	5	2 3/8 x 9 1/4	1
Undrilled Each			\$3.00
Drilled Each			\$3.75

Drilled fin supplied unless otherwise specified.

## ELECTROLYSIS COLLARS STREAMLINED ZINC DIE CASTINGS PRECISION MADE AND BALANCED

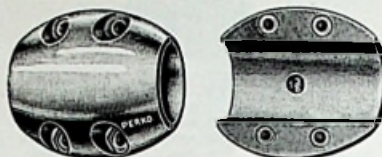

Fig. 252

The electrolysis collar is the least expensive way of protecting the most expensive parts of any boat against electrolytic action.

It is a precision made collar of pure zinc designed to fit properly on any propeller shaft regardless of shaft R.P.M.

These collars can be easily and almost instantly installed by anyone. They are dove-tailed, so the two halves will always locate themselves.

These collars not only protect vital underwater fittings such as propellers, struts, shafts, strut bolts, but stop pitting of all underwater fastenings.

No.	Each	Shaft Size Inches	Length Overall Inches	Diam. Overall Inches	Weight Pounds
1	\$ 2.75	3/4	2	2	3/4
2	2.75	7/8	2	2	3/4
3	3.00	1	2 1/4	2 1/4	1 1/8
4	3.00	1 1/4	2 1/4	2 1/4	1 1/8
5	3.00	1 1/4	2 1/4	2 1/4	1 1/8
6	3.50	1 3/4	2 3/4	2 1/2	1 3/8
7	3.50	1 1/2	2 3/4	2 1/2	1 3/8
8	4.00	1 3/4	2 3/4	3 1/4	2 1/2
9	4.00	2	2 3/8	3 1/4	2 1/2
10	6.00	2 1/2	1 3/4	5	4
11	6.00	3	1 3/4	5	4

## ELECTROLYSIS ELIMINATORS PURE ZINC

A necessity if the boat is used in salt water. Streamlined for mounting on the deadwood or planking. Arrests electrolysis of under water brass fittings.

### CAST TYPE



Fig. 244

No.	Each	Length Inches	Width Inches	Depth Inches	Weight Pounds
1	\$ .80	3 1/2	1 3/4	5/8	1/2
2	1.30	5 1/4	2 1/8	1	1 1/2

### DIE CAST TYPE

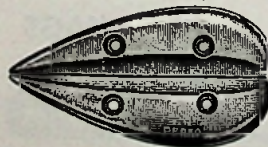

Fig. 253

Precision made, smooth and uniform. So designed that they can easily be divided into two identical parts if smaller sizes are desired.

No.	Each	Dimensions Inches	Weight Pounds
3	\$1.85	5 x 2 3/4	1 1/2
4	4.50	8 x 4	4



## STEERER AND CONTROL PARTS CAST BRONZE



1. Lever



6. Bulkhead Bracket



9. Shelf Plate



12. Collar

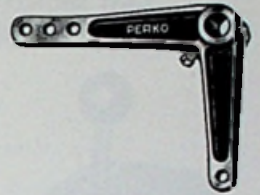

13. Angle Lever



2. Clevis



4. Elbow Clevis



7. Bulkhead Bracket



10. Deck Plate



3. Lever



5. Angle Clevis



8. Lower Bearing



11. Lower Bearing

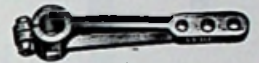

14-15. Lever

Fig. 865

No.	Item	Burnished Bronze Each	Polished Bronze Each	Chromium Plated Each	Length Overall Inches	Length C. to C. Inches	For Diam. Shaft Inches	For Diam. Pin Inches	Diam. Bolt Inches	Tapped For Rod Inches	Tapped For Pipe Inches	Width Jaw Inches	Width Base Inches	Diam. Flange Inches	Weight Pounds
1	Lever	\$ 8.90			8	6	1	1/2							1 1/4
1-A	Lever	10.00			10	†6-7-8	1	1/2							2 1/2
1-B	Lever	10.00			10	†6-7-8	1 1/8	1/2							2 1/4
1-C	Lever	10.00			10	†6-7-8	1 1/4	1/2							2 1/4
2	Clevis	3.15			2 1/2				1/2	3/4		1/2			1/2
2-A	Clevis	3.15			2 1/2				1/2		1/2	1/2			1/2
2-B	Clevis	4.00			4 1/6				1/2		3/4	1/2			1
2-C	Clevis	4.00			4 1/6				1/2	1		1/2			1
3	Lever	7.75			4 1/2	2 3/4	1	1/2							1
4	Clevis	6.90			3 1/2				1/2		3/4	1/2			1
4-A	Clevis	6.90			3 1/2				1/2	1		1/2			1
5	Clevis	4.75			3				1/2		3/4	1/2			3/4
5-A	Clevis	4.75			3				1/2	1		1/2			3/4
6	Bracket		\$6.00	\$8.00	6 1/8		1						1		3/4
7	Bracket		6.00	8.00	4 1/4		1						1		3/4
7-A	Bracket		6.00	8.00	4 1/4		1 1/8						1		3/4
8	Bearing	4.30			1		1							3 1/2	3/4
9	Shelf Plate		5.75	7.50	3 3/8		1					3 1/4			1 1/4
10	Deck Plate		4.60	5.75	1		1							4	1/2
10-A	Deck Plate		4.60	5.75	1		1 1/8							4	1/2
11	Bearing	4.40			1		1							3 3/4	1
12	Collar		2.55	3.40	1		1								1/4
12-A	Collar		2.55	3.40	1		1 1/8								1/4
13	Lever	10.90				*6-7-8	1	1/2							2
14	Lever	8.00				**5-6	3/4	1/2	3/16						1
15	Lever	9.20				5-6-7	1	1/2	3/8						1 1/2

Depth of Bearing—No. 8, 3/8 inches—No. 9, 1 inch—No. 11, 1 3/4 inches.

\*This applies to long arm. Length short arm center to center, 6 inches.

\*\*No. 14 has two pin holes instead of three illustrated.

†Nos. 1-A, 1-B, 1-C, are of heavy construction like No. 1, and with three pin holes like No. 15.

## Brass BALL JOINTS

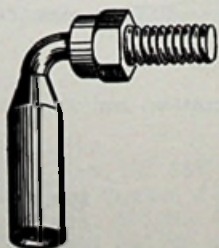

Fig. 792

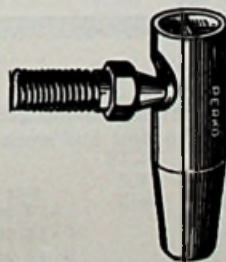

Fig. 793

Fig. 793 is adjustable for wear. Spring tension around ball with screw for adjusting.

No.	Fig. 792 Each	Fig. 793 Each	Thread Inches	Length Thread Inches	O. D. Female End Inches	Weight Ounces
1	\$.50	\$.70	1/4-20	1/2	3/16	1/2
2	.60	.80	3/8-18	1/2	7/16	1
3	.60	.80	1/4-28	1/2	3/16	1/2



## "Perkomatic" CONTROLS

FOR THROTTLE AND CLUTCH  
CAST BRONZE—CHROMIUM PLATED  
FOR USE WITH FLEXIBLE CONTROL CABLE FIG. 699

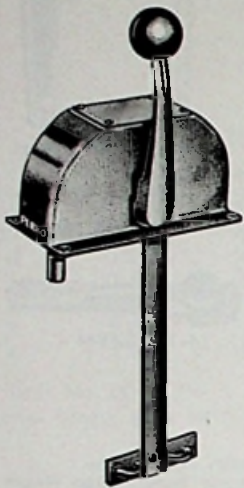

Fig. 698 No. 1

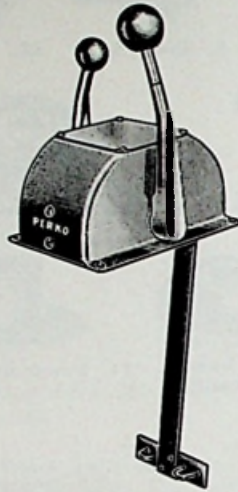

Fig. 698 No. 2

- No. 1 C—For single clutch
- No. 1 T—For single throttle
- No. 2 CT—For clutch and throttle
- No. 2 C—For double clutch
- No. 2 T—For double throttle

"Perkomatic" controls used by many leading boat builders as standard equipment.

A removable plate on top of housing permitting access to interior after installation for making various adjustments in tension, length of throw etc., also easier lubrication.

Knobs are black bakelite, levers are cast bronze and have adjustable tension.

Stock clevis is tapped 10-32, if other sizes required see Fig. 295 and specify.

No.	Each	Length Housing Inches	Width Base Inches	Height Housing Inches	Height Overall Inches	Weight Pounds
1	\$31.00	5 $\frac{3}{4}$	2 $\frac{7}{8}$	3	7	3
2	40.00	5 $\frac{3}{4}$	4 $\frac{1}{4}$	3	7	5

## "Teleflex" CONTROL CABLES

FOR FIG. 698 CONTROLS  
BLACK PLASTIC CONDUIT—THREAD 10-32

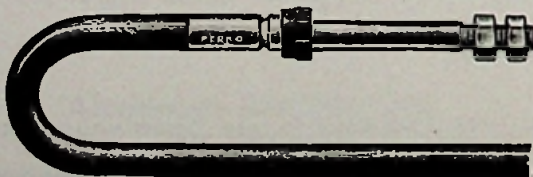

Fig. 699

Connecting part illustrated is on both ends.

Length Feet	Each	Length Feet	Each
8	\$15.15	16	\$23.00
10	17.15	18	25.00
12	19.10	20	27.00
14	21.00		

## New "Dynaform" CONTROLS

FOR THROTTLE AND CLUTCH  
CAST BRONZE—CHROMIUM PLATED FACE PLATE  
FOR USE WITH FLEXIBLE CONTROL CABLE FIG. 720

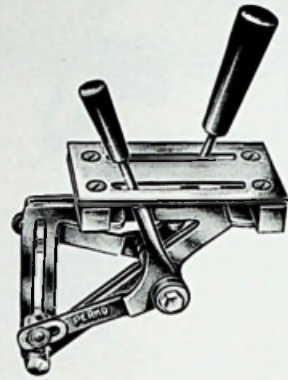

Fig. 711

- No. 1 C—For single clutch
- No. 1 T—For single throttle
- No. 2 CT—For clutch and throttle
- No. 2 C—For double clutch
- No. 2 T—For double throttle

A good practical control of simple design and construction. Its operation is smooth and positive, especially when used with our Fig. 720 teleflex control cable.

The lever handles are polished black bakelite. The clutch lever has neutral detent and tension of both levers is adjustable.

No.	Each	Length Face Plate Inches	Width Face Plate Inches	Weight Pounds
1	\$12.00	5 $\frac{3}{4}$	1 $\frac{1}{2}$	1 $\frac{3}{4}$
2	23.50	5 $\frac{3}{4}$	3	3 $\frac{1}{2}$

## "Teleflex" CONTROL CABLES

FOR FIG. 711 CONTROL  
BLACK PLASTIC CONDUIT—THREAD 10-32

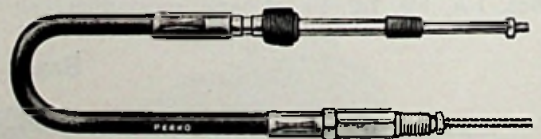

Fig. 720

"Teleflex" control cable is by reputation and construction the best and smoothest made.

Length Feet	Each	Length Feet	Each
8	\$14.00	16	\$22.30
10	16.00	18	24.35
12	18.20	20	26.50
14	20.25		



## Reverse Gear CONTROLS CAST BRONZE



Fig. 278

An ideal control for light installations, such as run-about small cruisers, etc. Clevis supplied for 1/2 inch pipe.

Polished Bronze Per Set	Chromium Plated Per Set	Length Overall Inches	Length Handle Inches	Size Base Inches	Weight Pounds
\$17.00	\$21.50	20	16	4 3/4 x 2 1/2	3 1/2

Spare clevises, see Fig. 865 Part No. 2.

## Clutch CONTROLS CAST BRONZE FOR 1 INCH SHAFT

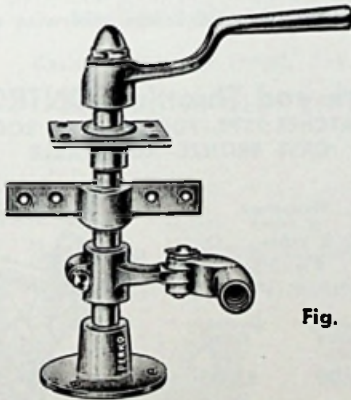

Fig. 822

Supplied with bulkhead bracket or shelf plate (please specify). Shaft is not included.

With 8" Handle Polished Bronze Per Set	With 8" Handle Chromium Plated Per Set	With 10" Handle Polished Bronze Per Set	With 10" Handle Chromium Plated Per Set	With 12" Handle Polished Bronze Per Set	With 12" Handle Chromium Plated Per Set
\$35.00	\$42.00	\$36.50	\$43.50	\$38.00	\$45.50

### SPARE PARTS

	Burnished Bronze Each	Polished Bronze Each	Chromium Plated Each
Acorn Nut		\$2.35	\$2.90
Shelf Plate, Fig. 865 No. 9		5.75	7.50
Bulkhead Bracket, Fig. 865 No. 6		6.00	8.00
Lever, Fig. 865 No. 3		\$7.75	
Clevis, Fig. 865 No. 4		6.90	
Lower Bearing, Fig. 865 No. 11		4.40	

## Clutch Control HANDLES CAST BRONZE—FOR 1 INCH SHAFT

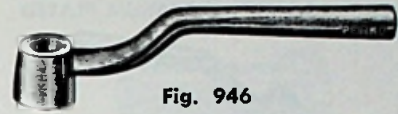

Fig. 946

Used with Fig. 822 clutch control.

Length from Center of Bore Inches	Polished Bronze Each	Chromium Plated Each	Weight Pounds
8	\$ 9.50	\$13.00	1 3/4
10	11.00	14.50	2
12	12.50	16.25	2 1/4

## Throttle CONTROLS RATCHET TYPE—CAST BRONZE

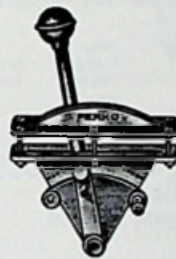

Fig. 715

For Bowden Wire

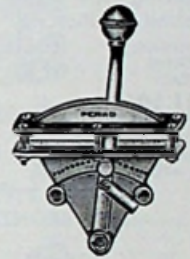

Fig. 716

For Control Rod

Knob is black bakelite.

Length of throw, 3 inches.

\*Rod socket is for 1/4, 5/16, or 3/8 inch rod.

Burnished Bronze Each	Chromium Plated Each	Length Plate Inches	Width Plate Inches	Weight Pounds
\$11.80	\$17.00	6	2 3/4	2

\*Supplied for 1/4 inch rod unless otherwise specified.

## Spark and Throttle CONTROL RATCHET TYPE—FOR CONTROL ROD CAST BRONZE

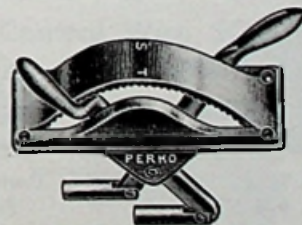

Fig. 331

Length of throw is 3 inches.

Rod sockets are for 1/4, 5/16, or 3/8 inch rod.

Polished Bronze Each	Chromium Plated Each	Length Plate Inches	Width Plate Inches	Weight Pounds
\$14.00	\$16.00	6	2 1/2	2 3/4

Supplied for 5/16 inch rod unless otherwise specified.



## "Sea-Way" Throttle CONTROLS RATCHET TYPE—FOR 3/8 INCH ROD CAST BRONZE—CHROMIUM PLATED

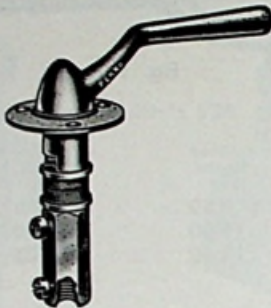

Fig. 847

A powerful control with a man sized handle. For mounting on top of wheel box or shelf.

A spring type ratchet inside handle hub holds control at desired position.

Chromium Plated Each	Length Handle Inches	For Diam. Rod Inches	Diam. Flange Inches	Weight Pounds
\$11.50	4½	3/8	2¾	1

## "Sea-Prince" Throttle CONTROLS RATCHET TYPE—FOR CONTROL ROD CAST BRONZE—CHROMIUM PLATED



Fig. 848

Same design and ability as the Sea-Way Control above but fitted with lever arm and socket for mounting on side of wheel box or bulkhead.

Length of throw is 5 inches.

Rod socket is for 1/4, 5/16 or 3/8 inch rod.

Chromium Plated Each	Length Handle Inches	Length Lever Arm Inches	Diam. Flange Inches	Weight Pounds
\$12.50	4½	3½	2¾	1

Supplied for 5/16 inch rod unless otherwise specified.

## Control CRANKS

BURNISHED CAST BRONZE—FOR CONTROL ROD



Side Type  
Fig. 636



Upright Type  
Fig. 637

Length Arms Inches	Height Overall Inches	Size Base Inches	Weight Single Ounces	Weight Double Ounces
2	2¾	2¼x¾	5	7
For Rod Inches	Single Complete Each	Double Complete Each	Cranks Only Each	Brackets Only Each
1/4	\$2.35	\$3.60	\$.60	\$.85
5/16	2.35	3.60	.60	.85
3/8	2.50	3.90	.60	.85

Supplied for 1/4 inch rod unless otherwise specified.

## Spark and Throttle CONTROLS RATCHET TYPE—FOR CONTROL WIRE CAST BRONZE

Length of throw is 3 inches.

Length Arc Inches	Extreme Projection Inches	Mounting Plate Inches	Weight Pounds
2¾	5	1½x1¾	¾
Single	Polished Bronze Each	Chromium Plated Each	
Double	\$7.00	\$ 9.00	
	9.00	11.50	

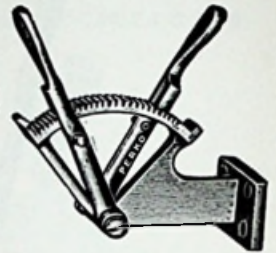

Fig. 409

## Spark and Throttle CONTROLS RATCHET TYPE—CAST BRONZE FOR CONTROL ROD OR BOWDEN WIRE

Size Frame Inches	Weight Pounds
6x3	1¾
Polished Bronze Each	Chromium Plated Each
\$9.00	\$12.00

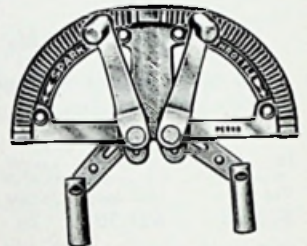

Fig. 691—For Rod  
Fig. 691—For Wire

For bulkhead up to 2 inches thick.

Length of throw, 3 inches.

Rod sockets are for 1/4, 5/16 or 3/8 inch rod.

Supplied for 1/4 inch rod unless otherwise specified.

## Spark and Throttle CONTROLS RATCHET TYPE—FOR CONTROL ROD CAST BRONZE—ADJUSTABLE

Dimensions of Base Inches	Dimensions of Frame Inches	Weight Ounces
2x7/8	4½x3¾	10
Polished Bronze Each	Chromium Plated Each	
\$6.00	\$8.00	

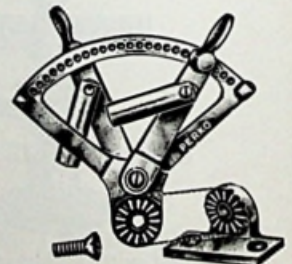

Fig. 904

## Control LEVERS PLAIN BRASS

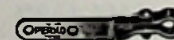

Fig. 354

No.	Each	Length Overall Inches	For Shaft Inches	For Clevis Pin Inches	Weight Ounces
1	\$1.00	2¾	¾	¾	1½
2	1.50	3¾	¾	¾	1½

Size No. 1 is used on controls Figs. 691 and 691-A.  
Size No. 2 is used on control Fig. 848.



**Improved CONTROL WIRE HANDLES**  
FOR CASING WITH RIGHT OR LEFT HAND LAY  
ALL BRASS—CHROMIUM PLATED

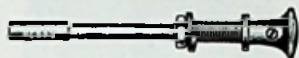

Fig. 692

Control wire and casing can be easily attached. No soldering necessary, wire held by set screw in knob. Casing threaded into tube. For use on a dash or bulkhead up to 2 inches thick.

Each	Length Overall Closed Inches	Outside Diam. Stem Inches	Weight Ounces
\$2.75	4 $\frac{7}{8}$	$\frac{3}{8}$	2

Left hand thread supplied unless otherwise specified.

**Bowden WIRE AND CASING**  
BRASS

$\frac{1}{4}$  INCH O.D. CASING—LEFT HAND LAY  
WIRE DIAMETER .072 INCHES



Fig. 353

50 FOOT LENGTHS ONLY  
Casing only, per length \$18.00  
Wire only, per length \$2.10

**Bowden Casing CLAMP**  
BRASS—SWIVEL TYPE—PLAIN



Fig. 352

Will hold control casing firmly while swivel feature allows smooth sliding of control wire in casing at any angle.

Each	Size Base Inches	Weight Ounces
\$ .85	2 $\frac{1}{4}$ x1	3

**CONTROL ROD SOCKETS**  
PLAIN BRASS

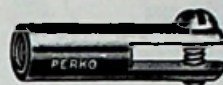

Fig. 328

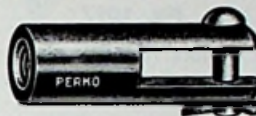

Fig. 295



Fig. 298

**Standard Fig. 328**

No.	Each	Tapped For Rod Inches	Outside Diam. Inches	Length Overall Inches	Between Jaws Inches	Length Jaws Inches
1	\$ .45	$\frac{1}{4}$ -20	$\frac{3}{8}$	1 $\frac{5}{8}$	$\frac{3}{16}$	$\frac{5}{8}$
2	.45	$\frac{3}{16}$ -18	$\frac{3}{16}$	1 $\frac{3}{4}$	$\frac{3}{16}$	$\frac{3}{4}$
3	.50	$\frac{3}{8}$ -16	$\frac{1}{2}$	1 $\frac{5}{8}$	$\frac{1}{4}$	$\frac{3}{4}$

**Heavy Duty Fig. 295**

4	\$ .55	$\frac{1}{4}$ -20	$\frac{1}{2}$	1 $\frac{5}{8}$	$\frac{1}{4}$	$\frac{3}{4}$
4-A	.60	$\frac{1}{4}$ -28	$\frac{1}{2}$	1 $\frac{3}{4}$	$\frac{1}{4}$	$\frac{3}{4}$
5	.65	$\frac{3}{16}$ -18	$\frac{1}{2}$	1 $\frac{3}{4}$	$\frac{1}{4}$	$\frac{3}{4}$
6	.65	$\frac{3}{8}$ -16	$\frac{1}{2}$	1 $\frac{3}{8}$	$\frac{1}{4}$	1 $\frac{1}{16}$
6-A	.60	10-32	$\frac{1}{2}$	1 $\frac{3}{4}$	$\frac{1}{4}$	$\frac{3}{4}$

**Heavy Duty Fig. 298**

7	\$ .65	$\frac{1}{4}$ -20	$\frac{3}{16}$	1 $\frac{3}{8}$	$\frac{1}{4}$	$\frac{3}{16}$
8	.65	$\frac{3}{16}$ -18	$\frac{3}{16}$	1 $\frac{3}{16}$	$\frac{1}{4}$	$\frac{3}{16}$
9	.65	$\frac{1}{4}$ -28	$\frac{3}{16}$	1 $\frac{3}{8}$	$\frac{1}{4}$	$\frac{3}{16}$

Length jaws measured to center of pin

**Control Wire SOCKETS**  
PLAIN BRASS

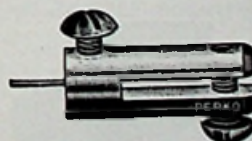

Fig. 679

Complete with brass set screws.

No.	Each	Length Inches	Diameter Inches	Between Jaws Inches	Length Jaws Inches	Weight Ounces
1	\$ .45	1	$\frac{3}{8}$	$\frac{1}{8}$	$\frac{1}{2}$	$\frac{1}{2}$
2	.60	1 $\frac{3}{8}$	$\frac{1}{2}$	$\frac{1}{4}$	1 $\frac{1}{16}$	$\frac{3}{4}$

Length jaws measured to center of screw.



## Gy-A-Liner ENGINE ALIGNERS

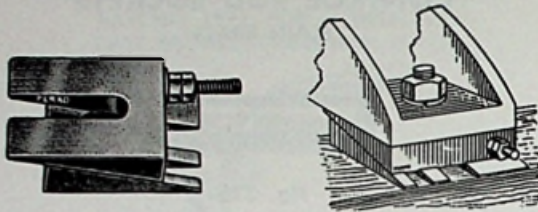

Fig. 1097

For use under motors having only single corner bed bolts. Can be used under intermediate propeller shaft bearings.

Each	Size Base Inches	Minimum Height Inches	Maximum Height Inches	For Engine Bolt Inches	Weight Pounds
\$2.50	2½x2½	⅝	1⅜	½	¾

## Flat BEARINGS GRAY IRON—BABBITED



Fig. 789

For Shaft Size Inches	Each	Dimensions of Base Inches	C. to C. Bolt Holes Inches	Diam. Bolt Holes Inches	Weight Pounds
¾	\$ 5.50	4¼x1⅜	3½	⅜	1½
⅞	5.85	4¼x4¼	3⅝	⅜	1¼
1	5.85	4⅞x1½	3¾	⅜	1½
1⅛	6.95	5¼x1⅝	4¼	⅜	2⅓
1¼	6.95	5½x1¾	4¼	⅜	2⅝
1⅝	8.75	5⅞x1⅞	4⅝	⅜	3½
1⅞	8.75	6¼x2	4⅞	⅜	4¼

## CAST BRONZE—NOT BABBITED

Fig. 809

For Shaft Size Inches	Each	Dimensions of Base Inches	C. to C. Bolt Holes Inches	Diam. Bolt Holes Inches	Weight Pounds
¾	\$ 5.00	4½x2	3⅝	⅜	1½
⅞	5.00	4½x2	3⅝	⅜	1½
1	5.00	4½x2	3⅝	⅜	1½

## Brass GREASE CUPS



Fig. 961

No.	Each	Height Closed Inches	Outside Diam. Inches	Pipe Thread Inches	Capacity Ounces
1	\$ .60	1⅞	⅜	⅛	¼
2	.90	1¾	1⅜	⅛	½
3	1.20	2	1⅞	⅛	¾

## Iron Shaft COUPLINGS CAST IRON

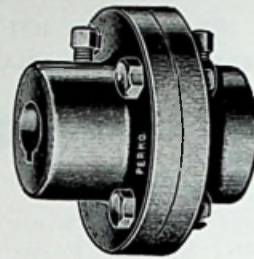

Fig. 327

No.	Each	For Diameter Shaft Inches	Diam. Flange Inches	Length Overall Inches	Wt. Lbs.
0	\$ 6.95	⅜, ¾	3	2⅝	2½
1	8.70	¾, ⅞, 1, 1⅛	4	3½	5½
2	11.00	1, 1⅛, 1¼, 1⅝, 1⅞	4½	4⅞	8

For divided sizes such as 1x1⅛, add \$1.80 each.

For ½ coupling add \$1.20 to half of above prices. No bolts furnished.

Specify Male or Female Half

## SIZE OF KEYWAY IN SHAFT COUPLINGS

Size Shaft Inches	Keyway Inches
⅜-¾	⅜
⅞-1-1⅛	¼
1¼	⅜
1⅝-1⅞	⅜

## Bronze Shaft COUPLINGS CAST BRONZE—BURNISHED

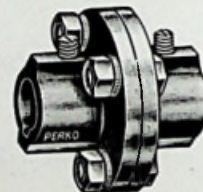

Fig. 389

Set Screws, Bolts and Washers are all Bronze.

Each	For Diameter Shaft Inches	Diam. Flange Inches	Length Overall Inches	Weight Pounds
\$9.50	¾, ⅞, 1	2⅝	2¾	1½

For divided sizes such as ¾ inch one end, 1 inch the other end, add \$ .50 each.

Specify Male or Female Half

¾ inch size has ⅜ inch keyway.

⅞ and 1 inch sizes have ¼ inch keyway.

## Sleeve Type Shaft COUPLINGS CAST BRONZE

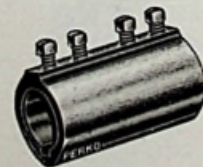

Fig. 378

No.	Each	For Diam. Shaft Inches	Length Inches	Keyway Inches	Weight Pounds
1	\$5.50	¾	3	⅜	¾
2	5.50	⅞	3	¼	¾
3	5.50	1	3	¼	¾





## STUFFING BOXES CAST BRONZE—REGULAR

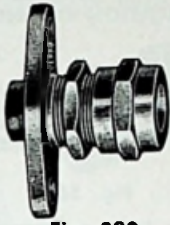

Fig. 320

Shaft Size Inches	Each	Size Flange Inches	For Diam. Bolt Inches	C. to C. Bolt Holes Inches	Length Bearing Inches	Weight Pounds
$\frac{3}{8}$	\$ 6.30	$3\frac{3}{8} \times 1\frac{3}{4}$	$\frac{3}{8}$	$2\frac{3}{8}$	$2\frac{1}{8}$	$1\frac{1}{8}$
$\frac{1}{4}$	6.60	$4 \times 1\frac{3}{4}$	$\frac{3}{8}$	$2\frac{5}{8}$	$2\frac{1}{8}$	$1\frac{1}{8}$
$\frac{3}{8}$	6.90	$4\frac{1}{8} \times 1\frac{3}{8}$	$\frac{3}{8}$	3	$2\frac{5}{8}$	$1\frac{1}{2}$
1	8.65	$4\frac{1}{4} \times 2\frac{1}{8}$	$\frac{3}{8}$	3	$2\frac{5}{8}$	$1\frac{3}{4}$
$1\frac{1}{8}$	9.35	$4\frac{3}{8} \times 2\frac{1}{8}$	$\frac{1}{2}$	$3\frac{3}{8}$	$2\frac{5}{8}$	2 $\frac{1}{4}$
$1\frac{1}{4}$	11.55	$5\frac{3}{4} \times 2\frac{3}{8}$	$\frac{1}{2}$	$4\frac{1}{8}$	$2\frac{5}{8}$	3
$1\frac{3}{8}$	12.50	$6\frac{1}{4} \times 3$	$\frac{1}{2}$	$4\frac{3}{4}$	3	$3\frac{1}{4}$
$1\frac{1}{2}$	14.00	$6\frac{1}{2} \times 3$	$\frac{1}{2}$	5	3	$3\frac{1}{2}$
$1\frac{3}{4}$	20.00	$7 \times 3\frac{3}{4}$	$\frac{3}{8}$	$5\frac{1}{2}$	4	$5\frac{1}{4}$

## Self Aligning STUFFING BOXES CAST BRONZE—RECTANGULAR FLANGE

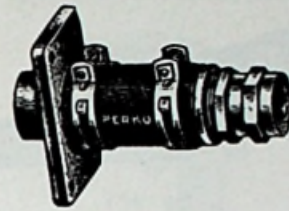

Fig. 734

No.	Each	For Shaft Inches	Size Flange Inches	Length from End of Box Inches	Weight Pounds
1	\$13.25	$\frac{3}{4}$	$5 \times 3\frac{3}{4}$	$6\frac{1}{2}$	5
2	14.50	$\frac{3}{4}$	$5 \times 3\frac{3}{4}$	$6\frac{1}{2}$	5
3	15.00	1	$5 \times 3\frac{3}{4}$	$6\frac{3}{4}$	5
4	18.50	$1\frac{1}{8}$	$6 \times 4\frac{1}{4}$	$7\frac{3}{4}$	9
5	20.00	$1\frac{1}{4}$	$6 \times 4\frac{1}{4}$	$7\frac{3}{4}$	$9\frac{1}{2}$
6	28.75	$1\frac{1}{8}$	$7 \times 4\frac{1}{2}$	8	$12\frac{1}{2}$
7	30.00	$1\frac{1}{2}$	$7 \times 4\frac{1}{2}$	$8\frac{1}{4}$	13

## Extra Heavy STUFFING BOXES RECTANGULAR FLANGE—CAST BRONZE

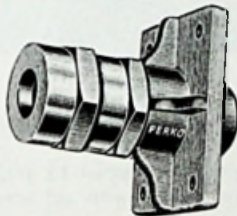

Fig. 819

Shaft Size Inches	Each	Size Flange Inches	For Diam. Bolt Inches	C. to C. Bolt Holes Inches	Length Bearing Inches	Weight Pounds
1	\$17.00	5 x 3	$\frac{1}{2}$	$3\frac{3}{4} \times 1\frac{3}{4}$	4	$5\frac{1}{2}$
$1\frac{1}{8}$	18.50	$5\frac{1}{2} \times 3\frac{3}{8}$	$\frac{1}{2}$	$4\frac{1}{4} \times 2\frac{1}{4}$	$4\frac{1}{4}$	$6\frac{1}{2}$
$1\frac{1}{4}$	23.65	$5\frac{5}{8} \times 3\frac{3}{8}$	$\frac{1}{2}$	$4\frac{3}{8} \times 2\frac{1}{4}$	$4\frac{1}{4}$	$6\frac{1}{2}$
$1\frac{3}{8}$	28.60	6 x 4	$\frac{1}{2}$	$4\frac{1}{8} \times 2\frac{1}{2}$	5	9
$1\frac{1}{2}$	33.50	6 x $4\frac{3}{8}$	$\frac{1}{2}$	$4\frac{1}{2} \times 3$	$5\frac{1}{2}$	10
$1\frac{3}{4}$	42.90	$6\frac{1}{2} \times 4\frac{1}{2}$	$\frac{3}{8}$	$5\frac{1}{8} \times 3\frac{1}{4}$	7	$13\frac{1}{2}$
2	52.80	$7\frac{3}{4} \times 5$	$\frac{3}{8}$	$5\frac{3}{8} \times 3\frac{3}{8}$	$7\frac{3}{8}$	$15\frac{1}{2}$

## Flax Packed STUFFING BOXES and STERN BEARINGS WITH RECTANGULAR FLANGE

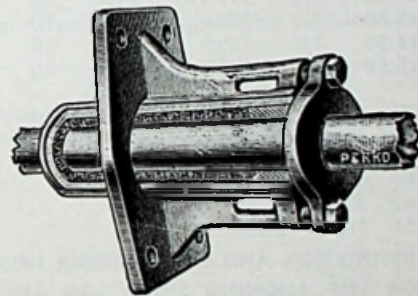

Fig. 811

Shaft Size Inches	Each	Size Flange Inches	Length Bearing Inches
1	\$23.10	$5\frac{3}{4} \times 3$	$5\frac{1}{4}$
$1\frac{1}{8}$	25.30	6 x 3	$5\frac{1}{2}$
$1\frac{3}{8}$	37.40	$7 \times 3\frac{3}{8}$	$5\frac{3}{4}$

## PACKING NUTS and LOCKNUTS FOR STUFFING BOXES—CAST BRONZE BURNISHED



Fig. 73



Fig. 79

Shaft Size Inches	For Fig. 320		For Fig. 819	
	Fig. 73 Each	Fig. 79 Each	Fig. 73 Each	Fig. 79 Each
$\frac{3}{8}$	\$1.80	\$ .70		
$\frac{1}{4}$	1.85	.75		
$\frac{3}{8}$	2.00	.80		
1	2.10	1.10	\$4.25	\$1.80
$1\frac{1}{8}$	2.40	1.20	4.60	1.85
$1\frac{1}{4}$	3.08	1.30	5.25	2.00
$1\frac{3}{8}$	3.40	1.45	5.90	2.15
$1\frac{1}{2}$	3.85	1.50	6.75	2.15
$1\frac{3}{4}$	4.65	2.00	8.35	2.75
2			9.25	3.00

## Bronze UNIVERSAL JOINTS CAST BRONZE—BURNISHED

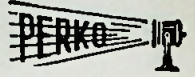

Fig. 93

No.	Bored Each	Tapped Each	Bored for Rod Inches	Tapped for Pipe Inches	Extreme Length Inches	Weight Pounds
1	\$ 9.50	\$10.00	$\frac{3}{4}$	$\frac{1}{2}$	$4\frac{1}{2}$	1
2	13.25	14.00	1	$\frac{3}{4}$	6	$2\frac{1}{4}$

Specify if for rod or pipe.

NOTE—LENGTH BEARING SHOWN DOES NOT INCLUDE PACKING NUT OR SPACE FOR PACKING.



## Self Aligning SHAFT LOGS

CAST BRONZE



Fig. 671

The stuffing box and base are connected by heavy wall rubber hose which cushions the propeller shaft and reduces vibration.

### LIGHTWEIGHT TYPE

No.	Each	Size Shaft Inches	Size Base Inches	Length Overall Inches	Degrees of Angle	Wt. Lbs.
0-L	\$11.75	5/8	9 3/8 x 2 1/2	15	12	3 1/2
1-L	11.75	3/4	9 3/8 x 2 1/2	15	12	3 1/2
3-L	14.50	1	9 1/2 x 2 3/8	15	12	3 1/2

### HEAVYWEIGHT TYPE

No.	Each	Size Shaft Inches	Size Base Inches	Length Overall Inches	Degrees of Angle	Weight Pounds
1-H	\$15.80	3/4	12 x 3 1/2	18	13	5 1/4
2-H	16.25	7/8	12 x 3 1/2	18	13	5 1/4
3-H	17.00	1	12 x 3 1/2	18	13	5 1/4
4	30.00	1 1/8	17 x 4 1/4	23 1/2	10	10 1/4
5	32.50	1 1/4	17 x 4 1/4	23 1/2	10	10 1/4
6	48.50	1 3/8	19 x 5	28	10	17 1/4
7	48.50	1 1/2	19 x 5	28	10	17 1/4

NOTE—Sizes Nos. 0-1-2-3 in both the lightweight and heavyweight types are drilled for screws. Balance of sizes are spotted but not drilled.

### STUFFING BOX AND EXTRA RUBBER HOSE FOR SELF ALIGNING SHAFT LOG AND STUFFING BOX



Fig. 672



Fig. 673



Fig. 1092

For Log No.	Size Shaft Inches	Stuffing Box Each	Hose Each	Hose Clamps Per Pair	I. D. Hose Inches	O. D. Hose Inches	Length Hose Inches
0-L	5/8	\$ 4.65	\$ .90	\$ .90	1 1/4	1 3/4	3 3/4
1-L	3/4	4.65	.90	.90	1 1/4	1 3/4	3 3/4
3-L	1	5.00	1.05	.90	1 1/2	1 7/8	3 1/2
1-H	3/4	5.30	1.20	1.20	1 1/4	2 1/4	4
2-H	7/8	5.60	1.20	1.20	1 1/4	2 1/4	4
3-H	1	7.00	1.20	1.20	1 1/2	2 1/4	4
4	1 1/8	11.00	1.90	1.90	2 3/8	3 3/8	5
5	1 1/4	11.75	1.90	1.90	2 3/8	3 3/8	5
6	1 3/8	15.50	2.40	2.40	2 3/4	3 1/2	5
7	1 1/2	15.50	2.40	2.40	2 3/4	3 1/2	5

Hose for Nos. 0-1-2-3 is 4 ply.

Hose for Nos. 4-5 is 6 ply.

Hose for Nos. 6-7 is 8 ply.

## Self Aligning SHAFT LOGS

CAST BRONZE

ALLOWS INSTALLATION OF ENGINE WELL AFT



Fig. 589

Base is drilled for bolts or screws.

No.	Each	For Size Shaft Inches	Size Base Inches	Length Overall Inches	Degrees of Angle	Wt. Lbs.
0	\$10.00	5/8 or 3/4	9x4	10	13	3 1/2
1	16.25	3/4	11x5	12 1/4	13	6
2	16.25	7/8	11x5	12 1/4	13	6
3	16.25	1	11x5	12 1/4	13	6
4	26.00	1 1/8	13x5 1/2	14 1/2	13	10
5	26.75	1 1/4	13x5 1/2	14 1/2	13	10

## Adjustable SHAFT LOGS

CAST BRONZE

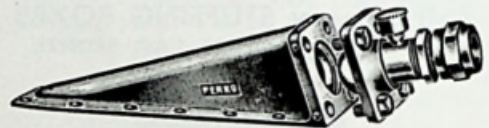

Fig. 577

Cast bronze ball and socket arrangement gives ample adjustment in all directions.

Range of adjustment between 12 and 25 degrees.

Flange bolts are locked with set screws.

No.	Each	Size Shaft Inches	Length Overall Inches	Length Base Inches	Width Base Inches	Wt. Lbs.
1	\$35.50	3/4	17 3/4	14	3 3/8	11
2	35.50	7/8	17 3/4	14	3 3/8	11
3	35.50	1	17 3/4	14	3 3/8	11
6	84.00	1 3/8	28 1/2	23	5 1/4	28
7	84.00	1 1/2	28 1/2	23	5 1/4	28

## Safety SHAFT COLLARS

MILLED BAR STEEL—MACHINED



Fig. 787

Size Shaft Inches	Each	Outside Diameter Inches	Width Inches	Weight Ounces
3/8	\$ .50	1 1/2	1/2	1 1/2
3/4	.55	1 1/4	3/8	2
7/8	.65	1 1/2	3/8	3
1	.80	1 3/4	3/8	3 1/2
1 1/8	1.10	1 3/4	5/8	4
1 1/4	1.30	2	5/8	5 1/2
1 3/8	1.30	2 1/8	3/4	6 1/2
1 1/2	1.50	2 1/4	3/4	7
1 3/4	2.90	2 3/4	3/4	13
2	3.15	3	3/4	15



**Adjustable STRUTS**

WITH MARINE BABBITT BEARING  
ALL CAST BRONZE

Side View

End View

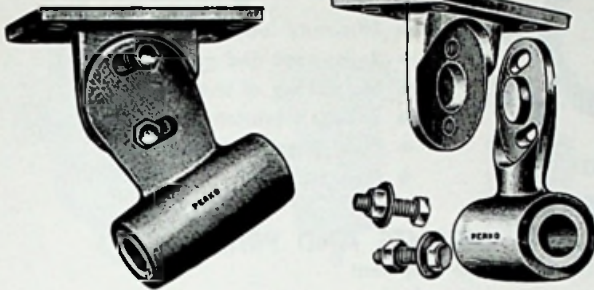

Fig. 628

Adjustable to any practical angle of the propeller shaft, held fast at necessary angle by two heavy bronze bolts. Bearing is of a special marine babbitt, the highest grade obtainable. Length of drop is figured from bottom of keel to center of shaft.

Size Shaft Inches	Width Flange Inches	Length Flange Inches	Length Bearing Inches	Weight Pounds
3/4	3	5 1/2	4 1/8	6 1/2
7/8	3	5 1/2	4 1/8	6 1/2
1	3	5 1/2	4 1/8	6 1/2
1 1/8	3	5 1/2	4 1/8	6 1/2
1 1/4	3 1/2	6 1/2	4 1/2	12 1/2
1 3/8	3 1/2	6 1/2	4 1/2	12 1/2
1 1/2	3 1/2	6 1/2	4 1/2	12 1/2

Lgth. Drop In.	Size Shaft Inches						
	3/4	7/8	1	1 1/8	1 1/4	1 3/8	1 1/2
5	\$27.75	\$27.75	\$27.75	\$27.75			
6	28.60	28.60	28.60	28.60	\$42.00	\$42.00	\$42.00
7	28.60	28.60	28.60	28.60	43.00	43.00	43.00
8	30.35	30.35	30.35	30.35	43.90	43.90	43.90
9	31.20	31.20	31.20	31.20	45.00	45.00	45.00
10	32.90	32.90	32.90	32.90	46.20	46.20	46.20
11	34.40	34.40	34.40	34.40	47.40	47.40	47.40
12					50.00	50.00	50.00

Specify size of shaft and length of drop, when ordering.

**Adjustable STRUTS**

FOR CUTLESS RUBBER BEARING  
CAST BRONZE—EXTRA HEAVY

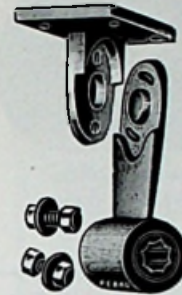

Fig. 1019

Size Shaft Inches	Width Flange Inches	Length Flange Inches	Length Bearing Inches	Weight Pounds
3/4	3	5 1/2	3	6 1/4
7/8	3	5 1/2	3 1/2	6 1/4
1	3	5 1/2	4	6 1/4
1 1/8	3	5 1/2	4 1/2	6 1/4
1 1/4	3 1/2	6 1/2	5	12
1 3/8	3 1/2	6 1/2	5 1/2	12
1 1/2	3 1/2	6 1/2	6	12

PRICES BELOW DO NOT INCLUDE RUBBER BEARING

For bearings see Fig. 1021.

Use bearings having the smallest outside diameter listed.

Lgth. Drop In.	Size Shaft Inches						
	3/4	7/8	1	1 1/8	1 1/4	1 3/8	1 1/2
5	\$27.20	\$27.75	\$28.30	\$28.60			
6	28.00	28.60	29.20	29.75	\$40.45	\$41.60	\$42.75
7	28.90	29.50	30.00	30.60	41.30	42.45	43.60
8	29.75	30.30	30.90	31.50	42.20	43.30	44.50
9			31.75	32.35	43.00	44.20	45.30
10			33.50	34.10	44.50	45.30	46.50
11					47.00	47.65	48.80
12					49.40	50.00	51.40

Specify size of shaft and length of drop, when ordering.

If desired, complete with rubber bearing, please specify.

**Exhaust Pipe FLANGES**

CAST BRONZE

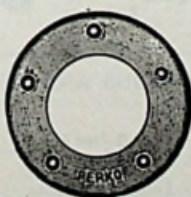

Fig. 214

For Pipe Inches	Burnished Each	Chromium Plated Each	Inside Diameter Inches	Outside Diameter Inches	Weight Pounds
2	\$2.85	\$4.00	2 13/32	4	1/3
2 1/2	3.25	5.00	2 29/32	4 1/2	1/2
3	4.70	6.50	3 17/32	5 1/2	3/4
3 1/2	5.00	7.00	4 1/2	6	1

**Exhaust Tube FLANGES**

CAST BRONZE

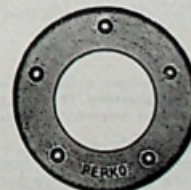

Fig. 738

For Tubing Inches	Burnished Each	Chromium Plated Each	Inside Diam. Inches	Outside Diam. Inches	Weight Pounds
2	\$1.50	\$2.80	2 1/8	4	1/3
2 1/2	2.90	4.50	2 3/8	4 1/2	1/2
3	3.50	5.30	3 1/8	5 1/2	3/4
3 1/2	4.70	6.50	3 3/8	5 1/2	3/4
4	5.00	7.00	4 1/8	6	1





**Improved Gasoline STRAINERS**  
**CAST BRONZE HOUSING**  
**WITH "KWICK KLEAN" FILTER ELEMENTS**  
**AND CORPRENE GASKETS**

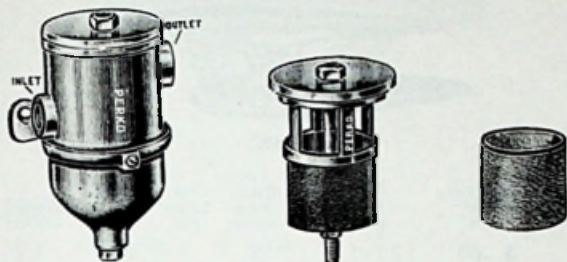

Fig. 299

The filter elements used are equivalent to 300 mesh screen cloth and are guaranteed to strain water from gasoline. They have a high flow rate, long life and are easy to clean. They can also be replaced in a few minutes by the removal of one nut. A soldering iron is not necessary.

Size No.	Complete Each	Spare Elements Each	Length Overall Inches	Diam. Inches	Tapped For Pipe Inches	Weight Pounds
1	\$14.90	\$.80	5½	2¾	¼ or ⅜	3¾
1½	19.75	.95	6¾	3¼	⅜ or ½	6
2	27.95	1.25	7¼	3¾	½ or ¾	8

Note—When ordering, be sure to specify pipe size, otherwise largest size shown will be supplied.

**FLAME ARRESTERS**

**REQUIRED BY LAW ON ALL MARINE CARBURETOR INSTALLATION**

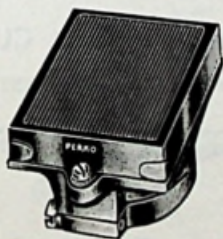

Fig. 464

A Flame Arrester attached to the air inlet of the carburetor eliminates the possibility of a fire being caused by backfiring through the carburetor.

Size No.	Style No.	Each	Inside Diam. Inches	Dimensions of Top Inches	Height Overall Inches
3	B-175-19A	\$13.25	1½	3⅝ x 2 ⅜	2 ⅛
4	B-175-14	15.10	2⅞	4⅞ x 2⅞	2 ⅜
5	B-175-12A	17.25	2⅞	5⅞ x 2⅞	2 19/32
6	B-175-12	17.25	2⅞	5⅞ x 2⅞	2 19/32
7	B-175-16	17.25	2⅞	5⅞ x 2⅞	2 19/32
8	B-175-13	19.80	3	5⅞ x 3 ⅞	2 19/32

**Intake Water STRAINERS**  
**CAST BRONZE**  
**STAINLESS STEEL STRAINER**  
**TRANSPARENT LUCITE CYLINDER**



Fig. 493

For installation between hull connection and water pump to the engine.

Lucite cylinders are difficult to break even when struck with hammer. Gaskets are corprene, (neoprene and cork) waterproof and resilient.

No.	Complete Each	Spare Cylinders Each	Spare Gaskets Each	Spare Strainers Each
1	\$22.00	\$ 5.00	\$.35	\$ 2.40
2	35.50	5.00	.45	3.75
3	37.00	5.20	.45	4.20
4	38.50	6.50	.45	4.75
5	48.50	10.50	.65	5.50
6	65.00	15.50	.65	8.00

No.	Pipe Size Inches	Size Cylinder Inches	Height Inches	Width Overall Inches	Weight Pounds
1	½	3½ x 4	6	4¼	3½
2	¾	4½ x 5	7¾	5½	6½
3	1	4½ x 5½	8¾	5½	6¾
4	1¼	4½ x 6	8¾	5½	7
5	1½	6 x 8	11½	7	12
6	2	6 x 12	17¼	9	22

Height does not include top nut or drain plug.

**Zinc Marine OILERS**

**SPRING BRASS BOTTOM**

No.	Complete Per Gross	Extra Spouts Per Gross
3	\$136.00	\$42.00

Capacity Ounces	Diam. Inches	Weight Per Gross Pounds
8	4	40

Supplied with 4 or 6 inch spouts, please specify.

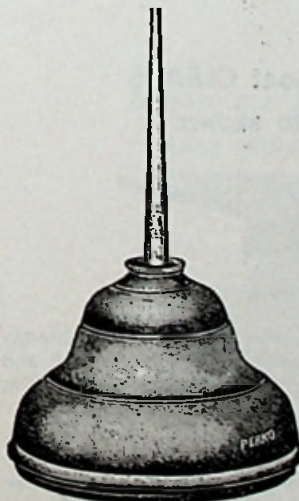

Fig. 326

NOTE — Our Fig. 494 "Engine Saver" has been discontinued but we can still supply anti-rust crystals at \$1.00 per pound.



**Cast Bronze  
Streamline CLEATS**

CHROMIUM PLATED



Fig. 850

Length Inches	Chromium Plated Each	Size Base Inches	For Diam. Rope Inches	For Screw No.	Packed Per Box	Weight Ounces
3	\$2.45	2 3/8 x 1 3/8	3/8	8	12	4
4 1/2	\$3.50	4 1/4 x 1 3/4	3/8	10	12	10

**Streamline CLEATS**

ZAMAK DIE CASTINGS—CHROMIUM PLATED  
SOLID BASE

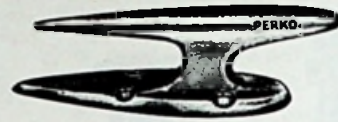

Fig. 566

Length Inches	Chromium Plated Each	Size Base Inches	For Diam. Rope Inches	For Screw No.	Packed Per Box	Weight Ounces
2	\$ .60	2 x 1	3/8	7	25	1 1/4
3	.75	2 3/4 x 1 3/8	3/8	8	25	2 1/2
4 1/2	1.40	4 3/8 x 1 3/4	3/8	10	10	6
6	2.10	5 1/2 x 2	3/4	12	5	11 1/2
7 1/2	3.35	4 3/8 x 2 3/4	1	12	5	24

**Cast Bronze  
Modern Design CLEATS**

CHROMIUM PLATED



Fig. 851

Length Inches	Chromium Plated Each	Size Base Inches	For Diam. Rope Inches	For Screw No.	Packed Per Box	Weight Ounces
3	\$2.50	1 1/8 x 1 3/8	3/8	8	12	2 1/2
4 1/2	3.60	1 3/4 x 1 1/2	3/8	8	12	6

**Modern Design CLEATS**

ZAMAK DIE CASTINGS—CHROMIUM PLATED



Fig. 1250

Length Inches	Chromium Plated Each	Size Base Inches	For Diam. Rope Inches	For Screw No.	Packed Per Box	Weight Ounces
3	\$1.15	1 1/2 x 1 1/4	3/8	8	30	2 1/2
4 1/2	1.55	1 3/8 x 1 1/2	1/2	8	10	8
6	2.25	2 1/4 x 2 1/4	3/4	10	5	13

**Solid Base Boat CLEATS**

DROP FORGED BRONZE



Fig. 544-A

These have much greater strength than cast bronze cleats. The finish is finer (no sand holes). They polish and plate to smoothness and brilliance not probable with castings.

Length Inches	Polished Bronze Each	Chromium Plated Each	For Screw No.	Packed Per Box	Weight Ounces
3	\$1.35	\$1.85	8	25	2 1/2
4	1.50	2.10	10	25	4
5	2.10	2.70	14	10	5 1/2
6	2.45	3.25	14	10	8

**Open Base Boat CLEATS**

GALVANIZED IRON OR CAST BRONZE

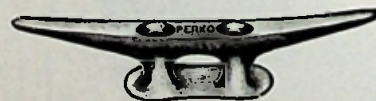

Fig. 544

Length Inches	Cast Iron Each	Mall. Iron Each	Polished Bronze Each	Chromium Plated Each	Galv. Weight Pounds
3 1/2	\$ .28	\$ .41			3/8
4	.30	.52	See Figure 544 A		1/4
5	.46	.64			3/8
6	.56	.93			1/2
8	1.20	1.70	\$3.90	\$ 4.90	1 1/4
10	2.10	2.65	6.00	7.85	2 1/4
12	3.15	3.70	8.00	10.00	3 3/4
14	4.50	6.40			6 1/4
18	7.75	11.45			11 1/2

Galvanized cleats supplied in cast unless otherwise specified.



### Hollow CLEATS

CAST BRONZE—CLOSED ENDS



Fig. 572

Length Inches	Polished Bronze Each	Chromium Plated Each	For Screw No.	Weight Pounds	Packed Per Box
4½	\$ 2.80	\$ 3.80	10	½	10
5½	3.10	4.30	10	⅝	10
6½	3.60	5.00	12	¾	10
8	4.90	6.40	¼"	1¼	
10	9.30	10.90	⅝"	2	
12	13.00	15.35	¾"	3	

### Ship CLEATS

CAST IRON—HEAVY



Fig. 511

Length Inches	Galv. Each	Size of Base Inches	Holes for Diam. Bolts Inches	Weight Each Pounds
8	\$2.45	4¼x2⅝	⅞	3
10	4.40	4¾x2½	½	5¾
12	7.25	6⅞x3	¾	10
15	9.00	7¼x3½	¾	14
18	13.60	7½x4	¾	20¼

### Fender CLEATS

ZAMAK DIE CASTINGS—CHROMIUM PLATED



Fig. 1248

Length Inches	Chromium Plated Each	Size Base Inches	For Screw No.	Packed Per Box	Weight Ounces
2¼	\$.75	1⅝x1	7	25	1½

### Double Jam CLEATS

CAST BRONZE—POLISHED



Fig. 1030

No.	Polished Bronze Each	Chromium Plated Each	Length Overall Inches	Width Inches	For Screw No.	Packed Per Box	Weight Ounces
0	\$1.15	\$1.50	3	⅞	6	12	2
1	1.40	1.80	4	½	7	12	3½
2	1.95	2.45	5	⅝	8	12	5½

### Automatic Jam CLEATS

CAST BRONZE—POLISHED

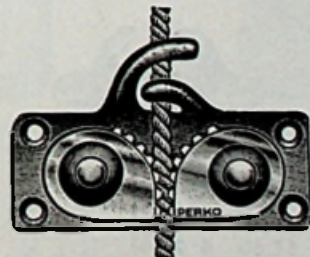

Fig. 895

Length Inches	Dull Finish Each	Polished Bronze Each	Chromium Plated Each	Size Base Inches	For Screw No.	Weight Ounces	No.	Each	For Rope Inches	Size Base Inches	For Screw No.	Weight Ounces
2¼	\$.70	\$1.00	\$1.20	1⅝x1	6	1½	1	\$8.50	¼ - ⅝	3½x1½	8	10
							2	8.50	⅝ - 1	5⅝x1¼	10	18



## Cast Bronze Modern Design Bow CHOCKS CHROMIUM PLATED

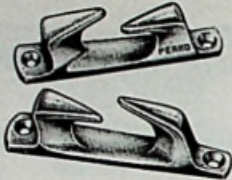

Fig. 852

Per Pair	Length Overall Inches	Width Base Inches	For Diam. Rope Inches	For Screw No.	Packed Pairs Per Box	Weight Per Pair Ounces
\$5.75	4	1 <sup>5</sup> / <sub>16</sub>	1/2	8	10	10

## New Modern Design Bow CHOCKS ZAMAK DIE CASTINGS—CHROMIUM PLATED



Fig. 1253

Per Pair	Length Overall Inches	Width Base Inches	For Diam. Rope Inches	For Screw No.	Packed Pairs Per Box	Weight Per Pair Ounces
\$2.60	4	1 <sup>3</sup> / <sub>16</sub>	1/2	8	10	7

## Bow CHOCKS GALVANIZED OR BRONZE



Fig. 546

Lgth. Inches	Galv. Iron Per Pair	Polished Bronze Per Pair	Chrom. Plated Per Pair	Width Inches	For Diam. Rope Inches	Bronze For Screw No.	Wt. Per Pair Lbs.
3	\$ .55	\$ 2.50	\$ 3.45	3/8	1/2	8	1/4
4	.62	3.00	4.10	3/8	5/8	10	1/2
5	1.10	4.25	5.50	3/8	3/8	10	1
6	1.95	8.30	9.70	1	1	14	1 1/2
8	3.00	11.00	14.00	1 1/4	1 1/4	14	3
10	4.90			1 3/4	1 1/4	3/8"	5 3/4
12	12.00	25.50	31.50	2	1 1/4	3/8"	11 3/4
15	20.00			3 1/2	1 3/4		40

NOTE—3, 4 and 5 inch sizes are forged bronze.

## Skene Bow CHOCKS

ZAMAK DIE CASTING—CHROMIUM PLATED



Fig. 1223

Per Pair	Length Overall Inches	Width Base Inches	For Diam. Rope Inches	For Screw No.	Packed Pairs Per Box	Weight Per Pair Ounces
\$1.50	3 1/2	3/8	3/8	8	10	4

## Straight Stern CHOCKS GALVANIZED OR BRONZE



Fig. 119

Lgth. Inches	Galv. Iron Each	Polished Bronze Each	Chrom. Plated Each	Width Inches	For Diam. Rope Inches	Bronze For Screw No.	Wt. Each Lbs.
4	\$ .37	\$1.60	\$ 2.10	3/8	3/4	8	1/4
5	.58	2.30	3.00	1	3/8	10	1/2
6	.87	3.20	4.65	1 1/8	1	12	3/4
8	1.80	5.80	7.80	1 5/8	1 1/8	14	1 1/2
10	2.80			1 3/4	1 1/2	3/8"	2 3/4
12	5.50		17.00	2 5/8	1 3/4	3/8"	7 1/2
15	10.75			3 3/4	1 3/4		20

NOTE—4 and 5 inch sizes are forged bronze.

## Streamline CHOCKS

FOR BOW OR STERN

ZAMAK DIE CASTINGS—CHROMIUM PLATED



Fig. 1240

The bow line can pass through these chocks at the usual angle without wear as the vertical part of each jaw is rounded for that purpose.

Per Pair	Length Inches	Extreme Width Inches	For Diameter Rope Inches	For Screw No.	Weight Ounces	Packed Pairs Per Box
\$2.50	4	1	1/2	10	3 1/2	10





## Skene Bow CHOCKS CAST BRONZE

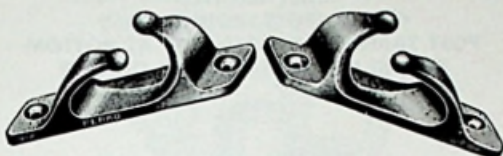

Fig. 160

Size No.	Polished Bronze Per Pair	Chromium Plated Per Pair	Length Inches	Width Inches	Opening Inches	Weight Per Pair Pounds
1	\$ 5.20	\$ 7.00	4½	¾	¾	¾
2	7.80	10.30	5½	1½	¾	1½
3	14.75	17.25	7¼	1¾	1	4

## Skene Stern CHOCKS CAST BRONZE



Fig. 161

Size No.	Polished Bronze Each	Chromium Plated Each	Length Inches	Width Inches	Opening Inches	Weight Each Pounds
11	\$ 2.60	\$ 3.50	4	¾	¾	½
12	3.90	5.15	5¼	1¼	1	1
13	6.60	8.50	7	1¾	1¼	2
14	10.00	12.00	9	2½	1¾	4

## RING BUOY HOLDERS CAST BRONZE



Fig. 1017

Burnished Bronze Each	Polished Bronze Each	Chromium Plated Each	Width Mounting Plate Inches	Hgt. Overall Inches	For Screw No.	Wt. Lbs.
\$2.00	\$3.50	\$4.45	3	4½	8	½

## LASHING HOOK FOR BOAT COVERS ZAMAK DIE CASTING—CHROMIUM PLATED



Fig. 1249

Chromium Plated Each	Length Overall Inches	Width Overall Inches	Inside Hook Inches	For Screw No.	Packed Per Box	Weight Ounces
\$.20	1½	½	¼	6	50	½

## BOAT COVER SOCKETS ZAMAK DIE CASTING—CHROMIUM PLATED

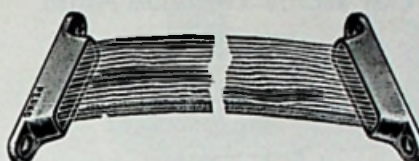

Fig. 578

An excellent item for preventing or eliminating sag in boat cover.

Sockets will accommodate a piece of wood lattice ¾ inches thick and up to 1¼ inches wide. Cut the lattice a few inches longer than the boat's width to obtain a low arch under the cover.

Per Pair	Length Overall Inches	Size Opening Inches	Width Overall Inches	For Screw No.	Weight Per Pair Ounces
\$ .90	3¼	1¾x¼	¾	8	2

## FITTINGS for Convertible Boat Tops DIE CASTINGS—CHROMIUM PLATED



Hinge No. 1



Socket Nos. 2 and 3



Eye End No. 4



Slide Nos. 5 and 6

Fig. 395

No.	Each	Item
1	\$1.10	Deck Hinge or Bracket
2	1.25	Socket for ¾ inch pipe
3	1.25	Socket for ¾ inch tubing
4	.80	Eye End for ¾ inch tubing
5	1.45	Slide for ¾ inch pipe
6	1.45	Slide for ¾ inch tubing

Average Weight - 2 ounces each



## Rope and Chain DECK PIPE FOR DANFORTH ANCHOR LINES CAST BRONZE—CHROMIUM PLATED



Fig. 750

When lightweight anchors are used a short length of chain is generally shackled to the rope line.

This new deck pipe will accommodate  $\frac{3}{4}$  inch line on a thimble, the shackle and  $\frac{1}{4}$  inch chain. It has a hook for hanging the chain, the weight of which holds the cover down.

Each	Dimensions of Flange Inches	Dimensions Inside Inches	Height Inches	Weight Pounds
\$11.90	5 $\frac{1}{4}$ x4	3 $\frac{3}{4}$ x2 $\frac{1}{2}$	1 $\frac{3}{8}$	2

## Rope DECK PIPES GALVANIZED CAST IRON OR CAST BRONZE

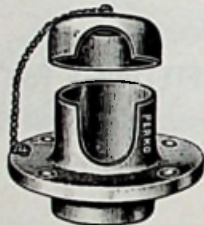

Fig. 741

No.	Galvanized Each	Chromium Plated Each	For Diam. Rope Inches	Inside Diam. Inches	Diam. Flange Inches	Weight Pounds
0		\$ 6.25	$\frac{3}{8}$	1 $\frac{1}{4}$	3	$\frac{3}{4}$
1	\$2.90	13.30	$\frac{3}{8}$ & 1	1 $\frac{3}{8}$	4 $\frac{1}{4}$	1 $\frac{3}{8}$

All sizes Drilled for No. 8 F.H. screw.

## BOW EYES CAST BRONZE



Fig. 303

Metal In Eye Inches	Length of Straps Inches	Extreme Length Inches	I.D. Eye Inches	For Screw No.
$\frac{3}{8}$	1 $\frac{3}{4}$	3	$\frac{3}{4}$	8
Burnished Bronze Each	Polished Bronze Each	Chromium Plated Each	Weight Ounces	Packed Per Box
\$1.25	\$1.85	\$2.35	3 $\frac{1}{2}$	5



Fig. 926

## Riding BITTS GALVANIZED CAST IRON

No.	Each	Height Inches	Size Base Inches	Weight Pounds
1 $\frac{1}{2}$	\$11.75	8 $\frac{1}{4}$	5 $\frac{1}{2}$ x5 $\frac{1}{2}$	9
2	22.00	10	5 $\frac{1}{2}$ x7 $\frac{1}{2}$	18

## Mooring BITTS

CAST BRONZE  
ROUND POST—ROUND BASE  
POST TAPERED TO HOLD LINE AT BOTTOM  
ROUND TO PREVENT WEAR ON LINE

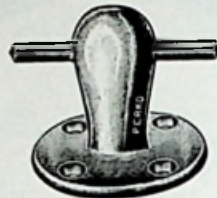

Fig. 597

No.	Polished Bronze Each	Chromium Plated Each	Diam. Base Inches	Height Inches	For Screw No.	Weight Pounds
1	\$5.75	\$7.50	2 $\frac{3}{4}$	2 $\frac{3}{8}$	10	$\frac{3}{4}$

## Mooring BITTS CAST BRONZE

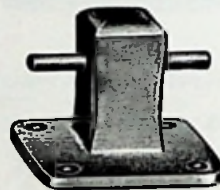

Fig. 608

No.	Polished Bronze Each	Chromium Plated Each	Size Base Inches	Height Inches	For Screw No.	Weight Pounds
1	\$ 6.35	\$ 8.75	3 x 3	2 $\frac{1}{2}$	10	$\frac{3}{8}$
2	10.00	13.10	4 $\frac{1}{4}$ x4 $\frac{1}{4}$	3 $\frac{1}{2}$	14	1 $\frac{1}{8}$
3	19.25	22.75	6 x 6	5	$\frac{3}{8}$ "	4 $\frac{1}{2}$
4	31.00	35.75	7 x 7	6 $\frac{1}{2}$	$\frac{1}{2}$ "	12

## Comb. BITT and Rope DECK PIPES CAST BRONZE

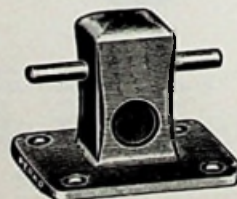

Fig. 431

A hollow one piece casting of minimum weight but maximum strength. An opening in one side of bitt to allow rope to be stored below deck but always ready for use.

No.	Polished Bronze Each	Chromium Plated Each	Size Base Inches	Height Inches	For Diam. Rope Inches	Weight Pounds
2	\$11.00	\$14.10	4 $\frac{1}{4}$ x4 $\frac{1}{4}$	3 $\frac{1}{2}$	$\frac{3}{4}$	1 $\frac{3}{4}$
3	20.25	23.75	6 x 6	5	1	4
4	32.50	37.25	7 x 7	6 $\frac{1}{2}$	1 $\frac{1}{4}$	12

No. 2 Drilled for  $\frac{1}{4}$  inch bolt.

No. 3 Drilled for  $\frac{3}{8}$  inch bolt.

No. 4 Drilled for  $\frac{1}{2}$  inch bolt.



**Improved BOW EYES**  
HIGH TENSILE FORGED BRONZE  
EXTRA STRONG SHANK

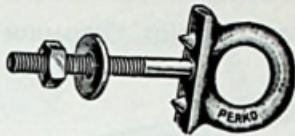

Fig. 238

No.	Dull Bronze Each	Chromium Plated Each	I.D. Eye Inches	Lgth. Shank Inches	Diam. Shank Inches	Weight Ounces
1	\$1.40	\$1.95	1	3 3/8	3/8	5 1/2
2	2.00	2.50	1	6	3/8	7

**Heavy Duty BOW EYES**  
CAST MANGANESE BRONZE

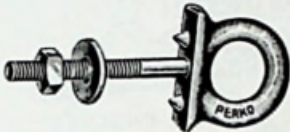

Fig. 238-A

Extra large and strong for small inboard and outboard cruisers.

No.	Burn. Bronze Each	Chromium Plated Each	I.D. Eye Inches	Length Shank Inches	Diam. Shank Inches	Weight Ounces
3	\$3.65	\$5.20	1 1/4	6	1/2	15

**BOW EYE**  
ZAMAK DIE CAST EYE—CHROMIUM PLATED  
BRONZE, SHANK, NUT AND WASHER

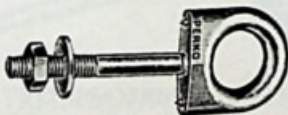

Fig. 1292

Each	I.D. Eye Inches	Length Shank Inches	Diam. Shank Inches	Weight Ounces
\$1.75	1	3	3/8	5

**RINGS WITH STRAPS**  
GALVANIZED MALLEABLE IRON OR CAST BRONZE

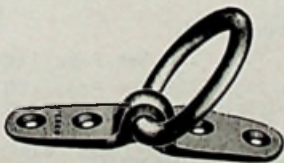

Fig. 1020

No.	Galvanized Each	Burnished Bronze Each	Chromium Plated Each	Size Strap Inches	For Screw No.	Weight Ounces
1	\$ .95	\$1.35	\$2.35	4 1/8 x 3/4	8	4 1/2
2	1.10			4 1/8 x 3/4	8	4 3/4

**BOW EYE ADAPTER**  
ZAMAK DIE CASTING—CHROMIUM PLATED

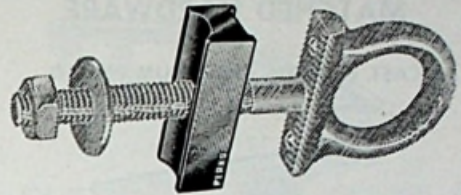

Fig. 397

For use with our Fig. 238 Bow Eye. The curved base fits snugly around the stem. Excellent for fibre glass or metal boats. Stock radius 3/8 inches.

Each	Length Inches	Width Inches	Thickness Inches	Weight Ounces
\$ .55	1 1/16	3/8	1/2	1

With special radius to order, in quantity, details on application.

**New BOW EYE ADAPTER**  
WHITE NYLON



Fig. 401

The strength and resilience of nylon permits this adapter to spread to an extreme radius to fit the wide stem of modern boats.

Each	Length Inches	Width Inches	Weight Ounces
\$ .35	1 1/16	3/8	3/4

**RING ON PLATE**  
CAST BRONZE—STREAMLINE PATTERN



Fig. 182

No.	Chromium Plated Each	Length Base Inches	Width Base Inches	Size of Ring Inches	Weight Ounces
1	\$3.00	2 3/4	1 1/2	3/16 x 1 1/4	2 3/4
2	3.40	3 1/4	1 3/8	3/32 x 1 1/2	3 1/2

Drilled for No. 8 Screw.

**RING ON PLATE**  
GALVANIZED DROP FORGED STEEL

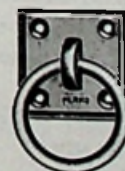

Fig. 607

No.	Galvanized Each	Size Ring Inches	Size Plate Inches	For Screw No.	Weight Per 100 Pounds
1	\$1.25	3/16 x 1 1/2	2 1/8 x 2 1/8 x 1/4	12	33
2	1.55	3/8 x 2	2 1/8 x 2 1/8 x 1/4	12	50



**MODERN DESIGN  
MATCHED HARDWARE**

CAST BRONZE—CHROMIUM PLATED



**CLEAT**  
Fig. 851

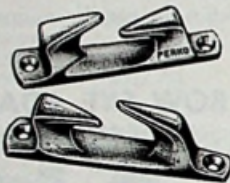

**BOW CHOCKS**  
Fig. 852



**TRANSOM HANDLE**  
Fig. 854



**BOW HANDLE WITH EYE**  
Fig. 853

**CLEATS AND CHOCKS**

Fig.	Length Inches	Each	Per Pair
851	3	\$2.50	
851	4½	3.60	
852	4		\$5.75

NOTE—For other details

Fig. 851 see page 118

Fig. 852 see page 120

**HANDLES**

Fig.	Each	Length Base Inches	Height Above Deck Inches	For Screw No.	Packed Per Box	Weight Ounces
853	\$6.75	7½	1¾	8	6	15
854	3.40	5¾	1⅝	8	6	8

**MODERN DESIGN  
MATCHED HARDWARE**

ZAMAK DIE CASTINGS—CHROMIUM PLATED

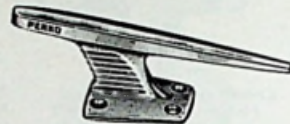

**CLEAT**  
Fig. 1250



**BOW CHOCKS**  
Fig. 1253



**TRANSOM HANDLE**  
Fig. 1254



**BOW HANDLE with EYE**  
Fig. 1269

**CLEATS and CHOCKS**

Figs.	Length Inches	Each	Per Pair
1250	3	\$1.15	
1250	4½	1.55	
1250	6	2.25	
1253	4		\$2.60

NOTE—For other details

Fig. 1250 See Page 118

Fig. 1253 See Page 120

**HANDLES**

Figs.	Each	Length Base Inches	Height Above Deck Inches	For Screw No.	Packed Per Box	Wt. Oz.
2254	\$1.65	5¾	1⅝	8	12	7
1269	3.60	11¾	2	10	6	18



**Round Grip  
TRANSOM HANDLE**

ZAMAK DIE CASTING—CHROMIUM PLATED



Fig. 1231

Extra strong for heavy boats. The round grip has no sharp edges and is ample to accommodate a man size hand.

Each	Length Overall Inches	Length Inside Inches	Height Inside Inches	For Screw No.	Weight Ounces	Packed Per Box
\$1.40	6	3½	1¾	10	7¼	10

**BOW HANDLE**

ZAMAK DIE CASTING—CHROMIUM PLATED



Fig. 1217

This shorter handle allows the installation of Bow Light closer to stem of the boat as now required by new standard regulations.

Chromium Plated Each	Length Base Inches	Height Above Deck Inches	For Screw No.	Wt. Ozs.	Packed Per Box
\$2.45	7¾	1¾	8	11	10

**TRANSOM HANDLES**

CAST BRONZE OR ZAMAK DIE CASTING



Bronze Fig. 775  
Zamak Fig. 1222

Fig. 775

No.	Polished Bronze Each	Chromium Plated Each	Length Overall Inches	Length Inside Inches	For Screw No.	Weight Ounces
1	\$1.10	\$1.35	4¼	2⅝	6	2
2	1.75	1.95	5¾	3¾	8	4

Fig. 1222

\$1.20	5¾	3¾	8	3½
--------	----	----	---	----

**TRANSOM HANDLE**

ZAMAK DIE CASTING—CHROMIUM PLATED

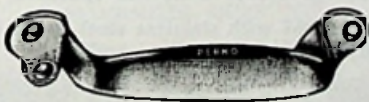

Fig. 1229

Chromium Plated Each	Length Overall Inches	Length Inside Inches	For Screw No.	Weight Ounces	Packed Per Box
\$1.10	5¾	3½	6	2½	10

**TRANSOM HANDLE**

GALV. MALLEABLE IRON



Fig. 361

Each \$ .80  
Size Opening Inches 3¼x1¼

Length Overall Inches 6½  
Weight Ounces 8

**Streamline BOW HANDLE**

ZAMAK DIE CASTING—CHROMIUM PLATED



Fig. 1238

An extremely good looking bow handle for small boats. A practical grab handle for cabin boats.

Chromium Plated Each	Length Overall Inches	Height Above Deck Inches	For Screw No.	Weight Ounces	Packed Per Box
\$3.25	13¾	1¾	8	14	5

**Streamline BOW HANDLE**

ZAMAK DIE CASTING—CHROMIUM PLATED



Fig. 1244

Combining good looks and practicability, a fine bow handle for small boats or grab handle for cruisers.

Chromium Plated Each	Length Base Inches	Height Above Deck Inches	For Screw No.	Weight Ounces	Packed Per Box
\$2.50	12	1¾	8	13	5

**BOW HANDLE**

ZAMAK DIE CASTINGS—CHROMIUM PLATED



Fig. 1221

Fig. 1234

Chromium Plated Each	Length Overall Inches	Height Above Deck Inches	For Screw No.	Weight Ounces	Packed Per Box
\$1.60	6½	2	8	5½	10

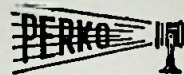

## STEP PLATES

ZAMAK DIE CASTING—CHROMIUM PLATED  
WITH BLACK OR WHITE MOULDED  
RUBBER STEP PADS



Fig. 1225

No.	Black Complete Each	White Complete Each	Frame Only Each	Overall Dimensions Inches	For Screw No.	Weight Ounces
0	\$1.35	\$1.45	\$1.00	8 x 2 1/4	4	6
1	1.80	1.90	1.35	8 3/4 x 3 3/4	6	8
2	2.75	2.95	2.10	11 1/2 x 5 3/4	8	12

Black supplied unless otherwise specified.

Packed per box—Nos. 0 and 1, 10 pieces. No. 2, 5 pieces.

## STEP PLATES

CAST BRONZE FRAME—CHROMIUM PLATED  
WITH BLACK OR WHITE MOULDED  
RUBBER STEP PADS

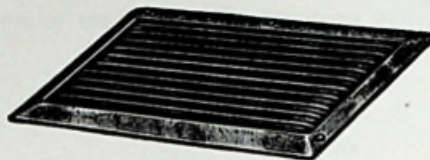

Fig. 1043

No.	Black Complete Each	White Complete Each	Frames Only Each	Overall Dimensions Inches	For Screw No.	Weight Pounds
0	\$2.70	\$2.80	\$2.35	8 x 2 1/4	4	1/2
1	4.75	4.85	4.40	8 3/4 x 3 3/4	6	3/4
2	6.50	6.70	5.85	11 1/2 x 5 3/4	8	1 3/4

Black supplied unless otherwise specified.

Packed per box—No. 1, 10 pieces, No. 2, 5 pieces.

## Rubber PADS Only

BLACK OR WHITE  
FOR FIGS. 1043 and 1225

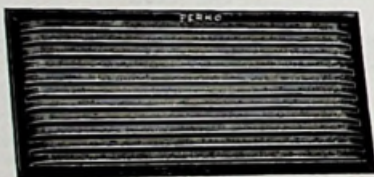

Fig. 1050

No.	Black Each	White Each	Length Inches	Width Inches	Thickness Inches	Weight Ounces
0	\$ .40	\$ .50	7 1/4	1 1/2	1/4	2
1	.50	.60	8	2 1/2	3/8	3 1/4
2	.65	.85	11	5	3/8	8 1/4

Black supplied unless otherwise specified.

Packed 10 pieces per box.

## Utility Rubber STEP PLATES

HEAVY CORRUGATED  
BLACK OR WHITE RUBBER WITH  
BRASS, CHROMIUM PLATED FRAME



Fig. 1044

No.	Black Each	White Each	Overall Dimensions Inches	Weight Pounds
3	\$4.65		8 1/2 x 3 1/2	1/2
4	5.50	\$ 6.20	10 x 4	3/4
5	6.70	7.40	13 x 5	1
6	7.20	8.75	17 x 6	1 1/2
7	7.75	10.00	18 x 7	2
9	6.70	8.25	12 x 8	1 1/2
10	8.25	10.50	15 x 10	2 1/4

Black supplied unless otherwise specified.

NOTE—Fig. 1044 with stainless steel frame is available to order, price on application.

## STEP PLATES

ZAMAK DIE CASTINGS—CHROMIUM PLATED  
BLACK OR WHITE RUBBER PADS

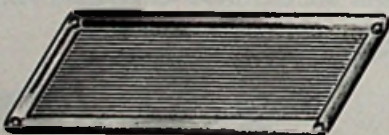
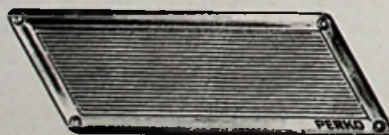

Fig. 1273

Supplied in pairs, one plate for each side of boat.

No.	Black Complete Per Pair	White Complete Per Pair	Overall Dimensions Inches	For Screw No.	Weight Per Pair Ounces
1	\$3.50	\$3.70	8 1/2 x 3 3/4	6	18

## Modern Design STEP PLATES

ZAMAK DIE CASTINGS—CHROMIUM PLATED  
BLACK OR WHITE RUBBER PADS

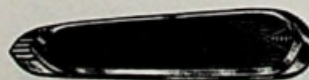

Fig. 1284

Certainly the most attractive step plate made for out-board and inboard boats.

No.	Black Complete Each	White Complete Each	Black Pads Each	White Pads Each	Overall Dimensions Inches	Weight Complete Ounces
1	\$1.90	\$2.00	\$ .40	\$ .50	8 x 2 1/4	5



**TRANSOM PLATES**

ZAMAK DIE CASTING—CHROMIUM PLATED WITH LEATHER PADS



Fig. 1224

Per Pair	Length Overall Inches	Inside Diameter Inches	For Screw No.	Weight Per Pair Ounces	Packed Pairs Per Box
\$1.10	3 3/8	1 1/8	7	2 3/4	25

**TRANSOM PLATES**

FORGED BRONZE—WITH LEATHER PADS

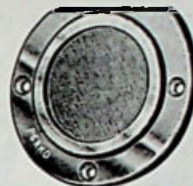

Fig. 814

Dull Finish Per Pair	Chromium Plated Per Pair	Outside Diameter Inches	Inside Diameter Inches	For Screw No.	Weight Per Pair Ounces
\$1.20	\$1.50	3	1 3/4	6	7

**Rubber TRANSOM PAD**  
NEOPRENE—WITH FORMICA INSERT



Fig. 199

Reduces noise and vibration.  
Protects both sides of transom.  
Fits all sizes and models of O.B. motors.

No.	Black Each	White Each	Extreme Width Inches	Weight Pounds
1	\$3.95	\$4.95	10 1/2	1 1/2
2	5.00		12 3/4	2
Giant	5.50		12 3/4	3

Note—Size No. 2 for 35 H.P. motors.  
Giant size for 50 H.P. and up.

**Rubber TRANSOM PAD**  
NEOPRENE—IN VARIOUS COLORS



Fig. 172

Reduces noise and vibration.  
Protects both sides of transom.  
Fits all sizes and models of O.B. motors.  
Colors are black, red, blue or green. Please specify.

Each	Extreme Width Inches	For Screw No.	Weight Pounds
\$2.75	10 3/4	8	1 3/4

**BATTERY BOX**  
GALVANIZED SHEET STEEL  
WITH GALVANIZED WROUGHT STEEL  
HOLDING BRACKETS  
FOR 6 VOLT STORAGE BATTERY

**BATTERY CONTAINER**  
GALVANIZED SHEET STEEL



Fig. 713

This container is designed for fastening to the under side of a seat, out of the way. It fits the 6 volt battery perfectly and has a rubber grommetted exit for the wires.

Supplied complete with two bronze 1/4" x 1 1/2" carriage bolts with wing nuts.

Each	Length Box Inches	Width Box Inches	Depth Box Inches	Weight Pounds
\$5.50	10 1/2	7 3/4	2 3/4	2 1/4

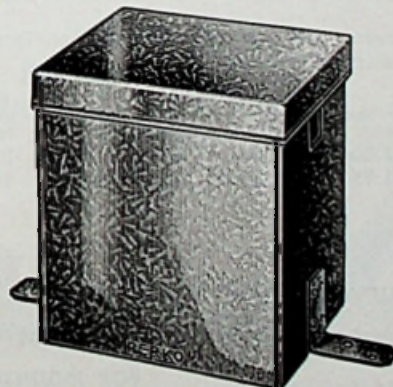

Fig. 712

To accommodate the wet storage battery necessary for outboard motors with electric self starters.

Has friction tight cover and opening for battery cable.

Each	Length Inside Inches	Width Inside Inches	Depth Inside Inches	Weight Pounds
\$7.00	9 1/2	7 1/2	10 1/2	4 1/4

### Water Ski TOWING HOOKS

ALL STAINLESS STEEL HOOK  
FOR MOUNTING THROUGH TRANSOM

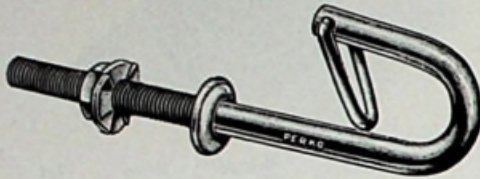

Fig. 862

For fast and full power get-away it is best to have towing line attached as low as possible to transom of boat, this hook answers that problem.

The vertical link prevents escape of line when skier is alongside.

The special washer prevents turning of hook in transom.

Each	Length Overall Inches	Length Thread Inches	Diameter Metal Inches	Packed Per Box	Weight Ounces
\$3.30	7	3 1/2	3/4	5	7

### Water Ski TOWING HOOKS

CAST BRONZE

These strong hooks securely attached to the port and starboard knees are just the thing for towing skiers, aquaplanes or boats.



Fig. 817  
Without Link



Fig. 861  
With Link

Link prevents tow line from jumping out. This unit also serves as a chock or hook for dock line.

Fig.	Burnished Each	Chromium Plated Each	Length Overall Inches	Width Inches	For Screw No.	Weight Pounds
817	\$2.00	\$3.50	3	1 3/4	12	1/2
861	1.95	3.80	3 1/4	1 3/4	12	1/2

### Curved REAR VIEW MIRROR

WIDE VISION—NON GLARE GLASS

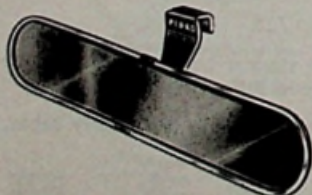

Fig. 400

FOR MOUNTING ON TOP OF WINDSHIELD.  
ADJUSTABLE

Each	Width Mirror Inches	Weight Pounds
\$6.25	11 1/4	1/2
Height Mirror Inches		
2 1/2		

### New REAR VIEW MIRROR

LEAD COATED GLASS—NON-GLARE  
ZAMAK DIE CAST BASE—CHROMIUM PLATED

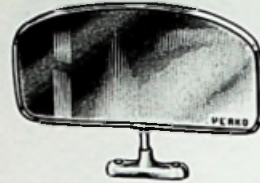

Fig. 436

Each	Width Mirror Inches	Height Mirror Inches	Height Overall Inches	Size Base Inches	Weight Pounds
\$5.85	8 1/2	4 1/4	6 1/8	2 7/8 x 3/4	3/4

### New REAR VIEW MIRROR

LEAD COATED GLASS—NON-GLARE  
ADJUSTABLE BRACKET FOR WINDSHIELD

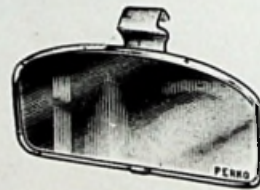

Fig. 427

Each	Width Mirror Inches	Height Mirror Inches	Weight Pounds
\$4.80	8 1/2	4 1/4	3/8

### Curved REAR VIEW MIRROR

WIDE VISION—NON-GLARE  
LEAD BACKED GLASS—SALT SPRAY TESTED  
ZAMAK DIE CAST BASE—CHROMIUM PLATED

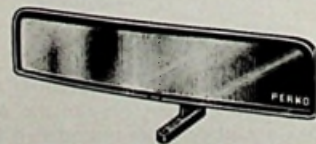

Fig. 406

Each	Width Mirror Inches	Height Mirror Inches	Height Overall Inches	Size Base Inches	Weight Pounds
\$8.50	12	2 1/4	4 1/2	3 3/4 x 3/4	3/4





**Streamline Base FLAG POLE SOCKETS**

ZAMAK DIE CASTINGS—CHROMIUM PLATED

FLUSH TYPE

UPRIGHT TYPE



**Bow**  
Fig. 1258



**Stern**  
Fig. 1259

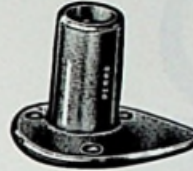

**Bow**  
Fig. 342

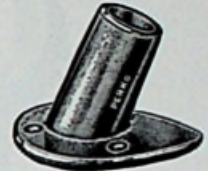

**Stern**  
Fig. 343

Fig.	Each	Inside Diam. Inches	Size Base Inches	Depth Socket Inches	Weight Ounces	Fig.	Each	Inside Diam. Inches	Size Base Inches	Height Overall Inches	Weight Ounces
1258	\$1.25	3/4	3x2 1/8	2	4 1/2	342	\$1.25	3/4	3x2 1/8	2	4 1/2
1259	1.25	3/4	3x2 1/8	2 1/8	4 1/2	343	1.25	3/4	3x2 1/8	2	4 1/2

Drilled for screw No. 6  
Packed 12 pieces per box.

**Round Base FLAG POLE SOCKETS**

GALVANIZED CAST IRON OR CAST BRONZE

FLUSH TYPE

UPRIGHT TYPE



**Bow**  
Fig. 218



**Stern**  
Fig. 219



**Bow**  
Fig. 220



**Stern**  
Fig. 221

Inside Diam. Inches	Galv. Each	Polished Bronze Each	Chromium Plated Each	Diam. Flange Inches	Depth Socket Inches	Weight Ounces	Inside Diam. Inches	Polished Bronze Each	Chromium Plated Each	Diam. Base Inches	Height Inches	Weight Ounces
3/4	\$ .50	\$1.85	\$2.20	2	1 1/2	4 1/2	3/4	\$2.75	\$3.40	2 1/8	1 1/4	7
1	.60	2.00	2.40	2 3/8	1 3/4	6	1	3.60	4.35	2 1/2	2	8 1/2
1 1/4	.70	2.40	2.90	2 3/8	2	10	1 1/4	4.30	5.25	2 3/4	2 1/8	11
1 1/2	1.00	2.75	3.25	3 3/8	2 3/8	16	1 1/2	4.30	5.25	3	3	16

Drilled for screw No. 8.  
Packed 6 pieces per box.

**LIFTING RINGS and KEEL PLATE**

MANGANESE BRONZE—FOR 3/8 INCH ROD



**WITH LOOSE DECK FLANGE**  
Fig. 412

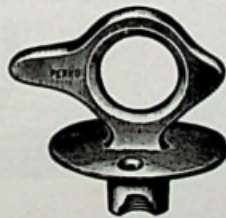

**WITH INTEGRAL DECK FLANGE**  
Fig. 415

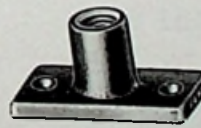

**KEEL PLATE**  
Fig. 446

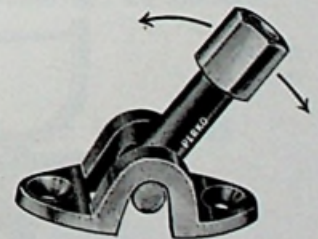

**KEEL PLATE**  
Fig. 447

Fig.	Burnished Bronze Each	Chromium Plated Each	I.D. Eye Inches	Stock in Eye Inches	Length Inches	Diam. Flange Inches	Size Flange Inches	Size Base Inches	For Screw No.	For Bolt Size	Weight Ounces
412		\$6.75	1 3/8	3/8	3 1/2	2			8		10
415		5.75	1 3/8	1/2	3 1/2				8		12 1/2
446	\$2.50						3x2 1/2				7
447	2.30							3 x 1 1/8 3 1/2 x 1 3/8		1/4" 1/4"	9

**Ribbed Socket ROWLOCKS**  
GALVANIZED—CAST IRON



Fig. 638

Size No.	Complete Per Pair	Horns Only Per Pair	Sockets Only Per Pair	Opening Inches	Weight Per Pair Pounds
0	\$1.15	\$.65	\$.50	1 3/4	1 1/8
1	1.25	.75	.50	2	1 1/4

**Standard Socket ROWLOCKS**  
GALVANIZED MALLEABLE IRON



Fig. 639

Size No.	Complete Per Pair	Horns Only Per Pair	Sockets Only Per Pair	Opening Inches	Weight Per Pair Pounds
0	\$1.75	\$1.25	\$.50	1 3/4	1 1/8
1	2.20	1.70	.50	2	1 1/4
2	2.85	1.85	1.00	2 1/4	1 3/4
3	4.00	2.90	1.10	2 1/2	2 3/8

**North River ROWLOCKS**  
WITH STANDARD SOCKET  
ZAMAK DIE CASTING—CHROMIUM PLATED



Fig. 1227

Chromium Plated Complete Per Pair	Horns Only Per Pair	Sockets Only Per Pair	Opening Inches	Weight Per Pair Ounces
\$3.50	\$1.95	\$1.55	1 3/4	15

**North River ROWLOCKS**  
GALVANIZED MALLEABLE IRON OR BRONZE

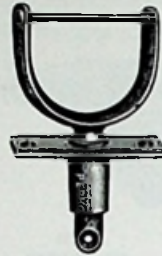

Fig. 643

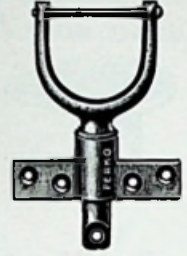

Fig. 644

Fig.	Complete Per Pair	Horns Only Per Pair	Sockets Only Per Pair	Opening Inches	Weight Per Pair Pounds
643 Galv.	\$2.25	\$1.75	\$.50	2 1/8	1 1/2
644 Galv.	2.95	1.75	1.20	2 1/4	1 1/2
643 Pl. Bronze	3.90	2.85	1.05	2 1/8	1 1/2
644 Pl. Bronze	4.60	2.85	1.75	2 1/8	1 1/2
643 Pol. Bronze	6.85	4.85	2.00	2 1/8	1 1/2
644 Pol. Bronze	8.05	4.85	3.20	2 1/8	1 1/2
643 Chrom. Pltd.	8.50	5.85	2.65	2 1/8	1 1/2
644 Chrom. Pltd.	9.95	5.85	4.10	2 1/8	1 1/2

Hole in horn shank for chain not included.

**North River ROWLOCKS**  
WITH FANCY SIDE PLATE  
GALVANIZED MALLEABLE IRON OR BRONZE

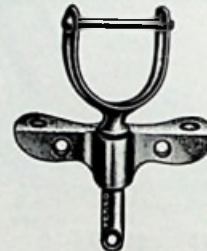

Fig. 652

	Complete Per Pair	Horns Only Per Pair	Sockets Only Per Pair	Opening Inches	Weight Per Pair Pounds
Galv.	\$ 3.30	\$1.75	\$1.55	2 1/8	1 1/2
Pl. Bronze	4.95	2.85	2.10	2 1/4	1 1/2
Pol. Bronze	9.15	4.85	4.30	2 1/8	1 1/2
Chrome Pltd.	10.80	5.85	5.00	2 1/8	1 1/2

**North River ROWLOCKS**  
WITH SIDE PLATE SOCKET  
ZAMAK DIE CASTING—CHROMIUM PLATED



Fig. 1228

Chromium Plated Complete Per Pair	Horns Only Per Pair	Sockets Only Per Pair	Opening Inches	Weight Per Pair Ounces
\$4.30	\$1.95	\$2.35	1 3/4	18

BRASS SAFETY CHAIN FOR ROWLOCKS, \$.50 PER PAIR  
NOTE—ALL ABOVE HORNS AND SOCKETS ARE INTERCHANGEABLE.



## Boston Side Plate ROWLOCKS GALVANIZED MALLEABLE IRON OR BRONZE



Fig. 646

Size No.	Complete Per Pair	Horns Only Per Pair	Sockets Only Per Pair	Opening Inches	Weight Per Pair Pounds
0 Galv.	\$ 2.85	\$1.40	\$1.45	1 1/4	1 1/4
1 Galv.	3.25	1.70	1.55	2	1 1/2
0 Pl. Bronze	4.50	2.40	2.10	1 1/4	1 1/4
1 Pl. Bronze	4.80	2.70	2.10	2	1 1/2
0 Pol. Bronze	8.80	4.50	4.30	1 1/4	1 1/4
1 Pol. Bronze	9.80	5.50	4.30	2	1 1/2
0 Chrome Pltd.	11.00	6.00	5.00	1 1/4	1 1/4
1 Chrome Pltd.	12.00	7.00	5.00	2	1 1/2

## Side Plate ROWLOCKS CAST BRONZE

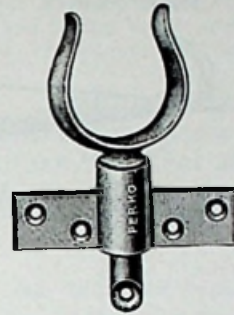

Fig. 645

Size No.	Complete Per Pair	Horns Only Per Pair	Sockets Only Per Pair	Opening Inches	Weight Per Pair Pounds
1 Pl. Bronze	\$5.15	\$3.30	\$1.85	2	1 1/4
1 Pol. Bronze	8.00	4.75	3.25	2	1 1/4
1 Chrome Pltd	10.65	6.55	4.10	2	1 1/4

## Davis Pattern ROWLOCKS GALVANIZED MALLEABLE IRON

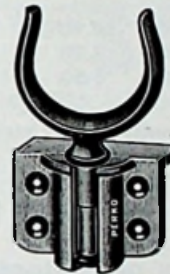

Fig. 641

Size No.	Per Pair	Opening Inches	Weight Per Pair Pounds
0	\$3.25	1 1/4	2
1	3.75	2	2
2	4.50	2 1/4	2 1/4

## Round Socket ROWLOCKS GALVANIZED MALLEABLE IRON OR BRONZE

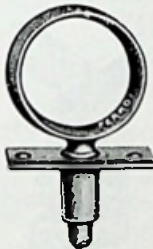

Fig. 642

Size No.	Complete Per Pair	Horns Only Per Pair	Sockets Only Per Pair	Inside Diam. Inches	Weight Per Pair Pounds
0 Galv.	\$1.85	\$1.35	\$ .50	2	1 1/8
1 Galv.	2.15	1.65	.50	2 1/4	1 1/4
2 Galv.	2.75	1.80	1.00	2 1/2	1 1/2
1 Pl. Bronze	4.35	3.30	1.05	2 1/4	1 1/4
1 Pol. Bronze	7.00	5.20	2.00	2 1/4	1 1/4
1 Chrome Pltd.	9.65	7.00	2.85	2 1/4	1 1/4

## Copper OAR and PADDLE TIPS



Fig. 794



Fig. 788

Fig. 794 Oar Tips—Per Pair	\$ .50
Fig. 788 Paddle Tips—Each	.30

## "SAV-OR" COMBINATION OAR SLEEVE AND STOP BLACK MOULDED NATURAL RUBBER



Fig. 648

An excellent item for adding years of life to a pair of oars plus noisless operation when fishing. Also serves as a sleeve for outrigger or fishing pole socket.

Each	Length Inches	Outside Diameter Inches	Inside Diameter Inches	Weight Ounces
\$1.65	9	1 1/4 to 2	1 1/2 to 1 3/4	6 1/2

## OAR LEATHERS and BUTTONS RUSSET LEATHER

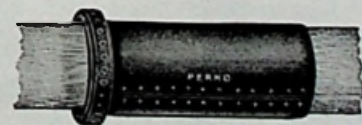

Fig. 233

	Per Pair
Complete, Leathers and Buttons	\$1.50
Leathers Only—7x6 1/2 inches	1.25
Buttons Only—1/2x13 inches	.25

NOTE—ALL ABOVE HORNS AND SOCKETS EXCEPT FIG. 641 ARE INTERCHANGEABLE



## BOAT HOOKS

GALVANIZED MALLEABLE IRON OR BRONZE  
SHARP POINTS



Fig. 223

Size No.	Galvanized Each	For Diam. Pole Inches	Extreme Length Inches	Weight Ounces
0	\$1.50	1	7¼	8
1	1.80	1¼	8¼	12
2	2.45	1½	9⅞	16
3	4.20	2	9¾	28

## BALL POINTS

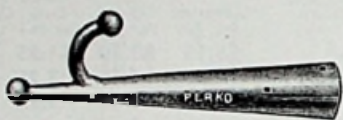

Fig. 224

Size No.	Galvanized Each	Polished Bronze Each	Chromium Plated Each	For Diam. Pole Inches	Extreme Length Inches	Wt. Ozs.
3½	\$1.50	\$3.90	\$4.90	1	7¾	9
4	1.80	4.20	5.20	1¼	8¼	12
5	2.45	5.50	6.50	1½	9¾	18
6	4.20			2	9½	28

NOTE—Pole end is measured by outside diameter to fit flush with surface of pole.

## Lightweight BOAT HOOK

ALUMINUM  
WHITE RUBBER GRIPS—RUBBER BUMPER

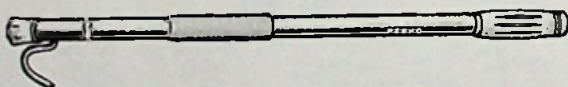

Fig. 226

This boat hook will float if dropped overboard. Has a strong wide hook for quick grab, rubber bumper for pushing.

Length Overall Feet	Each	Diameter Pole Inches	Weight Pounds
5	\$6.95	1	1½
6	7.60	1	2
7	8.25	1	2½

Special lengths made to order, price on application.

## BOAT HOOK HOLDERS

SPRING BRASS

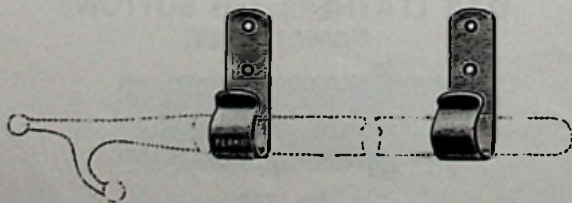

Fig. 490

Will accommodate poles up to 1½ inch in diameter, and hold them firmly in place.

Chromium Plated Per Pair	Length Inches	Width Inches	For Screw No.	Packed Per Box	Weight Ounces
\$2.00	3½	1	8	12 pr.	1½

## "Holdall" SPRING CLAMPS

18-8 STAINLESS STEEL—POLISHED

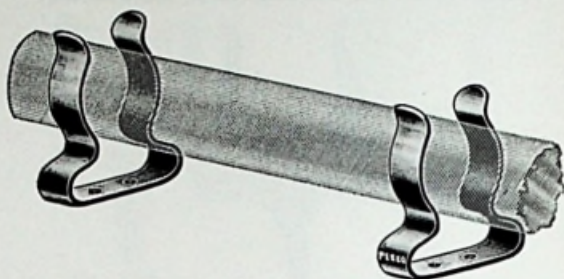

Fig. 502

Excellent for stowing fishing rods, boat hooks, oars, swab, broom, flashlight, flagstaff, pump, etc.

No.	Per Pair	Adjustability Inches	Length From Wall Inches	Width of Metal Inches	For Screw No.	Weight Per Pair Ounces
1	\$1.00	⅝ to 1¼	1½	½	6	2
2	1.25	1 to 1¼	2¼	⅝	6	2½

## New "Holdall" SPRING HOLDERS

NO. 316 STAINLESS STEEL—NON CORROSIVE  
STAINLESS STEEL SPRING—BRASS RIVET



Fig. 525

These are especially made for marine use. Not to be confused with the ordinary hardware store variety.

Each	Spread Inches	Length From Wall Inches	Weight Ounces
\$.90	up to 1¼	2¾	1

## BOAT HOOK HOLDERS

18-8 STAINLESS STEEL—POLISHED

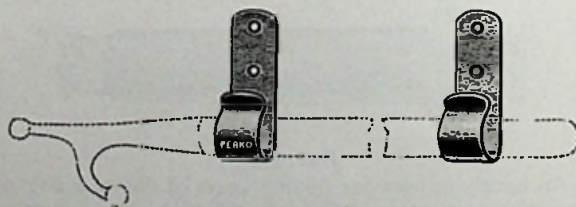

Fig. 492

Will accommodate poles up to 1½ inch in diameter, and hold them firmly in place.

Per Pair	Length Inches	Width Inches	For Screw No.	Packed Per Box	Weight Ounces
\$1.50	3½	1	8	12 pr.	1½



## HAND RAIL SOCKETS CAST BRONZE

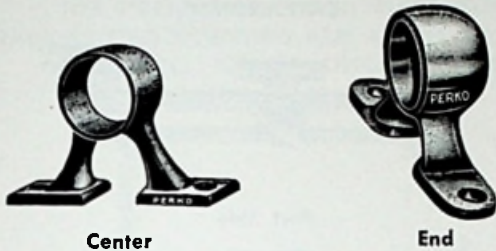

Center

End

Fig. 215

No.	Polished Bronze Each	Chromium Plated Each	For Diam. Rail Inches	Height Overall Inches	Size of Base Inches	Weight Ounces
1	\$3.00	\$4.00	1	1 1/4	3 1/2 x 5/8	5
2	3.50	4.50	1 1/4	2	3 3/4 x 3/4	9

Please specify whether center or end and size. Drilled for No. 10 screw.

## GRAB RAIL POSTS CAST BRONZE—HOLLOW

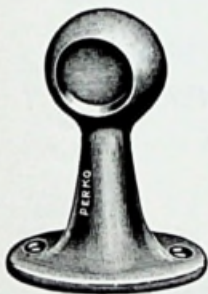

No.	Polished Bronze Each	Chromium Plated Each	Diam. Hole Inches
1	\$3.45	\$4.50	1 or 1 1/4
2		6.50	1 1/4

No.	Height Overall Inches	Diam. Base Inches	Weight Each Pounds
1	3 3/8	2 1/2	5/8
2	3 1/2	3	1 1/4

Fig. 380

Specify whether for center or end, also diameter of hole for No. 1 size. Drilled for No. 10 screw.



Fig. 614—For End  
Fig. 615—For Center

## STANCHION POSTS CAST BRONZE

No.	Chromium Plated Each	Bored For
2	\$3.00	3/8" rod
2 1/2	3.00	1/4" pipe

Extreme height 2 1/2" inches.

## Streamline GRAB RAIL POSTS

Notice that the tubing does not pass through the post but fits snug over an integral projecting part of post, hence, the post and tubing when assembled provides a smooth streamline unit. No unsightly bulges.

### NEW DESIGN ZAMAK DIE CASTINGS—CHROMIUM PLATED FOR 3/4 INCH O.D. 20 GAUGE BRASS TUBING



Fig. 1207 End Posts

Fig. 1208 Center Posts

Fig.	Each	Height Overall Inches	Dimensions Base Inches	For Screw No.	Weight Each Ounces	Packed Per Box
1207	\$1.75	1 1/4	1 7/8 x 1 3/8	10	6 1/2	6
1208	1.65	1 1/4	1 1/2 x 1 1/8	10	5	6

### CAST BRONZE—CHROMIUM PLATED FOR 5/8 INCH O.D. 22 GAUGE BRASS TUBING



Fig. 432 End Posts

Fig. 432-A Center Posts

Chromium Plated Each	Height Overall Inches	Dimensions Base Inches	For Screw No.	Weight Each Ounces	Packed Per Box
\$3.75	1 1/8	2 1/8 x 1 1/8	6	5	6

### CAST BRONZE—CHROMIUM PLATED FOR 1 INCH O.D. 20 GAUGE BRASS TUBING

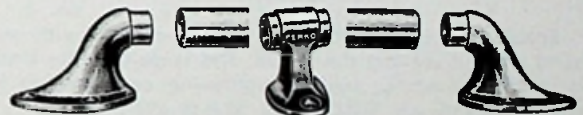

Fig. 413 End Posts

Fig. 413-A Center Posts

Chromium Plated Each	Height Overall Inches	Dimensions Base Inches	For Screw No.	Weight Each Ounces	Packed Per Box
\$5.25	2 1/4	3 x 2	8	10	6

## GRAB RAILS CAST BRONZE POSTS—BRASS TUBING

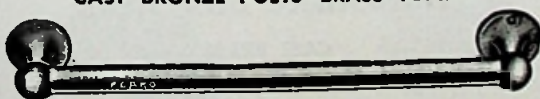

Fig. 379

No.	Chromium Plated Each	Length Between Posts Inches	Diameter Tubing Inches	Diameter Base Inches
1	\$11.50	12	1	2 1/2
2	12.50	18	1	2 1/2

Longer lengths, add \$2.50 each foot or fraction thereof.

NOTE—Lengths longer than these listed above are made to order only and are not returnable.

Not supplied in lengths longer than 6 feet.

## TUBING FOR ABOVE BRASS—CHROMIUM PLATED

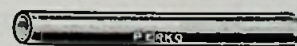

Fig. 498

Outside Diameter Inches	B & S Gauge	Per Foot
5/8	22	\$1.40
3/4	20	1.70
1	20	2.00

Above prices apply to 6 foot lengths only. Lengths shorter than 6 feet add \$.10 per foot. Not supplied in lengths longer than 6 feet.



## WINDSHIELD ADJUSTERS

ZAMAK DIE CASTINGS—CHROMIUM PLATED

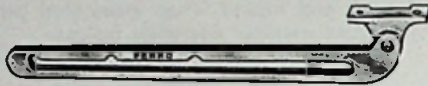

**Side Mounting**  
Fig. 1290

**Offset Mounting**  
Fig. 1291

Per Pair	Length Overall Inches	Length Adjustment Inches	Diam. Knob Inches	Weight Pounds
\$9.50	12	9½	1¾	1½

NOTE—When ordering ½ pair, specify whether for port or starboard side.

## "Skipper" WINDSHIELD ADJUSTER

ALL BRASS—CHROMIUM PLATED  
FOR HEAVY CRUISER WINDSHIELDS

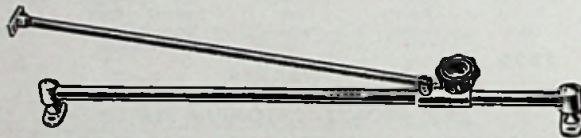

Fig. 360

Enables the skipper to adjust the windshield with one hand without leaving the wheel. The large bakelite knob is used for pushing, pulling, tightening or loosening in one operation.

No.	Each	Length Base Overall Inches	Length Windshield Arm Inches	Length of Adjustment Inches	Weight Pounds
1	\$20.00	18	16½	13½	3
2	22.50	27½	23	22½	3¾

Specify sizes to order, price on application.

## New WINDSHIELD ADJUSTERS

ALL BRASS—CHROMIUM PLATED

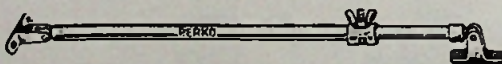

Fig. 1180

A powerful non-slip grip keeps this adjuster in desired position.

Each	Length Closed Inches	Length Open Inches	Diam. Outside Tube Inches	Weight Ounces
\$9.50	12	21	½	10

## WINDSHIELD ADJUSTERS

CAST BRONZE

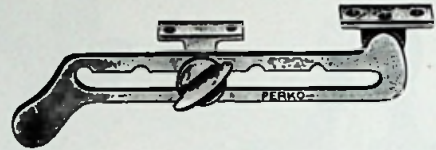

Port Side

Fig. 82

No.	Polished Bronze Per Pair	Chromium Plated Per Pair	Length Overall Inches	Length Adjustment Inches
1	\$13.50	\$16.25	6½	5
2	15.70	19.25	9	7
3	18.40	22.75	12	9½

NOTE—When ordering ½ pair, specify whether for port or starboard side.

## WINDSHIELD KEEPER or HATCH FASTENER

WROUGHT BRASS

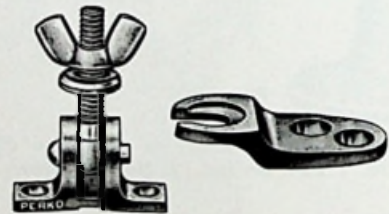

Fig. 697

Locks the windshield or hatch preventing rattles and assisting in keeping same watertight.

Bright Per Set	Chromium Plated Per Set	Base of Keeper Inches	Base of Plate Inches	Weight Ounces
\$2.40	\$4.00	1½×¾	1¼×¾	3½

A set consists of parts illustrated.

## WINDSHIELD ADJUSTERS

CAST BRASS

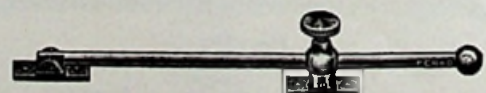

Fig. 1116

No.	Polished Brass Each	Chromium Plated Each	Length Inches	Diam. Rod Inches	Weight Ounces
1	\$6.50	\$7.00	8	¾	11
2	6.55	7.25	10	¾	12
3	6.60	7.30	12	¾	13



**Hand WINDSHIELD WIPERS**

FOR STRAIGHT OR CURVED WINDSHIELDS  
 STAINLESS STEEL EXTENSIBLE ARM AND BLADE HOLDER  
 OTHER PARTS, BRONZE, CHROMIUM PLATED  
 RUSTPROOF — LEAKPROOF



Fig. 533



No. 1 with Straight Blade      No. 2 with Curved Blade

Nothing to get out of order, operates very smoothly by a flip of the wrist. The improved spring tension of the arm holds blade firmly against the glass.

The arm is extensible from 9 to 12 inches, spring tension is adjustable for best wiping pressure.

No. 1 Each	No. 2 Each	* Length Overall Inches	Diam. Shaft Inches	Length Handle Inches	Weight Ounces
\$7.25	\$7.75	15 to 18	3/8	2 3/8	8

\*Length with 12 inch blade.  
 For thickness of wood up to 1 1/8 inches.

**NOTE: No. 1 can be supplied with 10 inch Blade, please specify.**

Spare Arm .....	each	\$1.50
Spare Straight Blade .....	each	.80
Spare Curved Blade .....	each	1.15

To prevent scratching Plexiglas, do not operate wiper on dry windshield.

**RUBBER INSULATION for Windshields**  
 BLACK



Fig. 667 For Bottom



Fig. 668 For Sides

Live moulded rubber for glass 1/4 inch thick.

Fig.	Per Foot
667	\$ .16
668	.11

Fig. 667—Supplied only in 50 ft. lengths.  
 Fig. 668—Supplied in lengths of 50 feet or longer.

**FENDER HOOKS**

GALVANIZED MALLEABLE IRON OR BRASS



Fig. 547

No.	Galv. Each	Bright Brass Each	Chromium Plated Each	For Rope Diam. Inches	Size Plate Inches	Weight Ounces
1	\$ .35	\$ .65	\$ 1.30	5/8	1 3/8 x 1 1/4	1 1/4
2	.75	.80	1.60	1/2	2 1/4 x 1 3/4	2 3/4

No. 1 for No. 6 screw, packed 25 per box.

No. 2 for No. 8 screw, packed 10 per box.

**FENDER HOOKS**

ZAMAK DIE CASTING—CHROMIUM PLATED

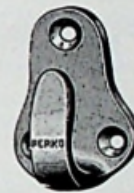

Fig. 1246

Chromium Plated Each	For Rope Diameter Inches	Size Plate Inches	For Screw No.	Packed Per Box	Weight Ounces
\$ .65	3/8	1 3/4 x 1 1/4	6	25	1 1/4

**WOOD RAIL HINGES and LOCKS**

CAST BRONZE—STAINLESS STEEL PINS



Fig. 122

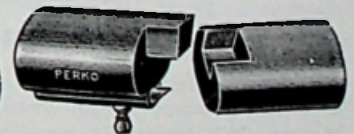

Fig. 123

Lock has spring latch on bottom.

Fig. 122

No.	Polished Bronze Each	Chromium Plated Each	Size Rail Inches	Length Inches	Weight Pounds
1	\$13.00	\$14.00	2 1/8 x 1 1/8	5	2
2	12.50	13.50	2 3/8 x 1 1/4	3 3/4	1 1/2

Fig. 123

No.	Polished Bronze Per Set	Chromium Plated Per Set	Size Rail Inches	Length Inches	Weight Pounds
1	\$13.75	\$14.50	2 1/8 x 1 1/8	5	1 3/8
2	13.25	14.00	2 3/8 x 1 1/4	3 3/4	1 1/2



## Regular DECK PLATES

CAST BRONZE—WITH KEY



Fig. 526

Diam. Opening Inches	Machine Finish Complete Each	Polished Chromium Plated Complete Each	Keys Only Each	Outside Diam. Plate Inches	Weight Pounds
1	\$ 2.75	\$ 4.50	\$ .30	2½	½
1½	3.55	5.25	.35	3¼	¾
2	4.30	6.55	.35	3¾	¾
2½	5.50	7.85	.65	4½	1
3	6.50	8.90	.65	4¾	1½
3½	8.40	11.00	.70	5½	1¾
4	10.00	13.25	.70	5¾	2
5	14.85	19.00	.85	7¼	2¾
6	17.20	23.00	1.55	8¼	5
8	41.50	56.00	2.20	10¼	7

Caps only, price is 50% of complete plate.

## DECK PLATE KEY

CAST BRONZE—BURNISHED  
ADJUSTABLE TO ALL SIZES OF DECK PLATES  
IMPROVED UNBREAKABLE PINS

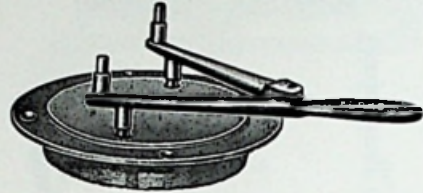

Fig. 826

Will fit all sizes of deck plates up to 8 inch diameter, making it unnecessary to have separate keys for each plate.

Each	Length Overall Inches	Weight Pounds
\$2.40	8½	1

## GAS TANK CAPS

WITH DECK FLANGE AND 15 INCHES OF CHAIN  
ZAMAK DIE CASTINGS—CHROMIUM PLATED

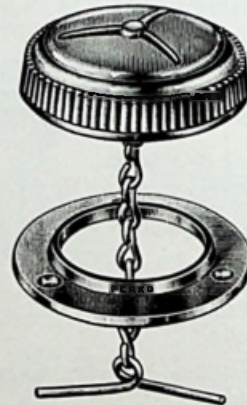

Fig. 1245

Each	Threaded for Pipe Inches	Height Overall Inches	Diam. Deck Flange Inches	For Screw No.	Weight Ounces	Packed Per Box
\$3.50	1½	1½	3¾	7	9½	6

## Pipe DECK PLATES

CAST BRONZE—WITH KEY—I. P. S. THREAD



Fig. 528

Words, "water," "gas," "oil" or "fuel" shown in flange of all sizes except ¾ inch when specified, otherwise unmarked deck plates are supplied.

Note, markings are in flange instead of cap. This is an obvious advantage as plate is identified when cap is removed.

Pipe Size Inches	Machine Finish Complete Each	Polished Chromium Plated Complete Each	Keys Only Each	Outside Diam. Plate Inches	Weight Pounds
¾	\$ 3.15	\$ 4.20	\$ .25	2½	½
1	3.60	4.80	.30	2¾	¾
1¼	4.40	5.95	.30	3¾	¾
1½	5.25	6.95	.30	3¾	1
2	6.30	7.85	.45	4¼	1½
2½	8.10	9.20	.45	4¾	2
3	11.25	11.80	.55	5¾	2½

Caps only, price is 50% of complete plate.

CAST BRONZE—CHROMIUM PLATED

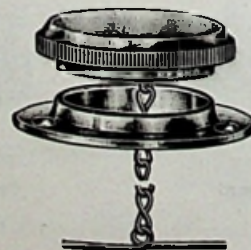

Fig. 520

Each	Threaded for Pipe Inches	Height Overall Inches	Diam. Deck Flange Inches	For Screw No.	Weight Pounds
\$6.70	1½	1½	3¾	8	1





## Gas Tank VENT CAST BRONZE WITH FLANGED NUT — NO ELBOW BRONZE WOOL SCREEN

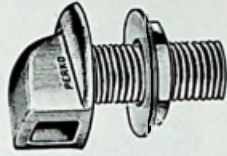

Fig. 512

	Chromium Plated Each	Pipe Size Inches	For Wood Inches	Weight Ounces
Plain Each	\$2.25			
	\$3.95	$\frac{3}{8}$	$1\frac{1}{8}$	5

## Gas Tank VENTS CAST BRONZE — WITH FLANGED ELBOW BRONZE WOOL SCREEN

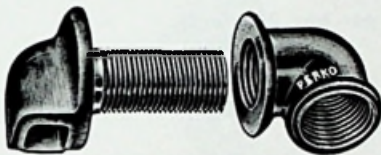

Fig. 503

No.	Plain Each	Chromium Plated Each	Pipe Size Inches	For Wood Inches	Weight Ounces
1	\$3.20	\$4.50	$\frac{3}{8}$	$1\frac{1}{8}$	8
2	3.20	4.50	$\frac{1}{2}$	$1\frac{1}{4}$	8

## Cockpit SCUPPER CAST BRONZE WITH RUBBER BALL BACK WATER CHECK

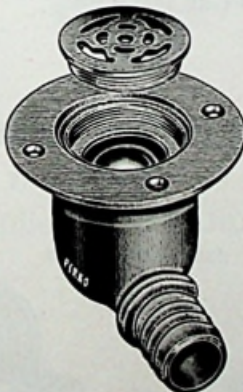

Fig. 142

Especially needed in sailboats when outlet is below the waterline.

No.	Plain Each	Chromium Plated Each	Diameter Flange Inches	Diameter Grate Inches	For Diam. Hose Inches	Weight Pounds
1	\$ 7.00	\$ 8.95	$3\frac{1}{4}$	$1\frac{1}{4}$	1	$1\frac{1}{4}$
2	10.50	12.75	$3\frac{3}{4}$	$2\frac{1}{4}$	$1\frac{1}{2}$	2

## "Neptune" Marked LEAD LINES WITH VINYLITE PLASTIC MARKERS 1-INCH CIRC. ITALIAN HEMP LINE

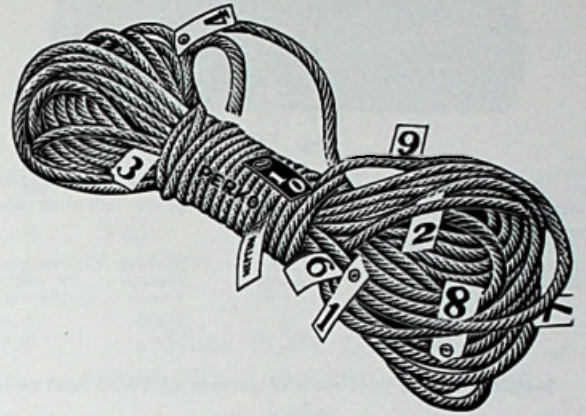

Fig. 190

A lead line that makes sense and can be easily read by anyone using it regardless of experience.

Instead of the old cryptic markings, it makes use of colored Vinylite Plastic Markers printed with numerals in contrasting colors. These markers are soft and resilient, unaffected by salt, grease, oil and sunlight.

The Neptune line was widely used during the war by the Navy, Army and U. S. Maritime Commission.

Length Fathoms	Each	Length Fathoms	Each
7	\$ 7.85	25	\$18.25
10	9.45	30	21.30
15	12.60	40	28.35
20	15.00	50	35.00

Longer lengths made to order, price on application.

NOTE: Markings up to 10 fathoms inclusive marked every fathom and half fathom, the latter indicated by yellow strip.

Longer lines marked according to Navy standard i.e. 2-3-5-7-10-13-15-17-20 fathoms and every 5 fathoms thereafter.

## SOUNDING LEADS



Fig. 940

All weights from 2 to 16 pounds each inclusive carried in stock.

	Per Pound
2 to 5 Pounds	\$ .78
6 to 14 Pounds	.75
Larger Sizes	.72



## Nylon Covered TILLER ROPE 7x8 AIRCRAFT CABLE — VERY FLEXIBLE



Fig. 760

The nylon coating cushions the wires against abrasion and protects them against oils, detergents, alkalis and oxidizing acids.

Outside Diameter Inches	Per 100 Feet	Core Diameter Inches	Breaking Strength Pounds	Weight Per 100 ft. Pounds
$\frac{3}{32}$	\$16.00	$\frac{3}{32}$	1000	1.6
$\frac{1}{16}$	21.00	$\frac{3}{32}$	1000	3.6

Supplied in 250 foot reels or cartons of 10-35 foot coils.

## Vinyl Covered TILLER ROPE

Same appearance and construction as Fig. 760 above but with blue transparent polyvinyl plastic covering. High quality.

Fig. 857

Outside Diameter Inches	Per 100 Feet	Core Diameter Inches	Breaking Strength Pounds	Weight Per 100 ft. Pounds
$\frac{1}{16}$	\$12.00	$\frac{3}{32}$	1000	2.6

Supplied in 250 foot reels or cartons of 10-35 foot coils.

## Tiller Rope CLAMPS ZAMAK DIE CASTINGS



Fig. 1226

For Rope Diam. Inches	Natural Finish Each	Chromium Plated Each	Length Inches	Width Inches	Weight Ounces
$\frac{1}{8}$	\$.30	\$.40	$1\frac{1}{8}$	$\frac{3}{16}$	$\frac{3}{4}$
$\frac{3}{16}$	.32	.45	$1\frac{1}{4}$	$\frac{1}{8}$	1
$\frac{1}{4}$	.43	.57	$1\frac{1}{2}$	$\frac{3}{8}$	$1\frac{1}{4}$

Packed per box 50 pieces.

## GALVANIZED IRON AND CAST BRONZE



Fig. 358

For Rope Diameter Inches	Galv. Each	Plain Bronze Each	Width Inches	Length Inches	Packed Per Box	Weight Ounces
$\frac{1}{8}$	\$.30	\$.40	$\frac{3}{4}$	$1\frac{1}{8}$	20	$1\frac{1}{4}$
$\frac{3}{16}$	.33	.44	$\frac{3}{4}$	$1\frac{1}{4}$	20	2
$\frac{1}{4}$	.40	.58	1	$1\frac{1}{4}$	20	3
$\frac{3}{16}$	.54	.70	1	2	10	$3\frac{1}{2}$

## Tiller Rope TIGHTENERS

For eliminating slack and keeping tension on tiller rope at all times.

### SHORT TYPE CADMIUM PLATED STEEL OR ALL BRASS



Fig. 732

Maximum Pull—Steel—110 Pounds  
Maximum Pull—Brass—90 Pounds

Steel Each	All Brass Each	Normal Length Inches	Length Compressed Inches	Outside Diameter Inches	Weight Ounces
\$.40	\$.85	4	5	$1\frac{1}{16}$	$4\frac{1}{2}$

Packed per box 25 pieces.

### LONG TYPE CADMIUM PLATED STEEL



Fig. 754

Maximum Pull—No. 1—100 Pounds  
Maximum Pull—No. 2—125 Pounds

No.	Each	Normal Length Inches	Length Compressed Inches	Outside Diameter Inches	Weight Ounces
1	\$.30	$5\frac{1}{2}$	$6\frac{3}{4}$	$\frac{7}{8}$	4
2	.40	$5\frac{3}{4}$	$7\frac{3}{4}$	$\frac{3}{4}$	5

Packed per box 25 pieces.

## Tiller ROPE GUIDES

### BRASS SPRING WIRE



Fig. 229

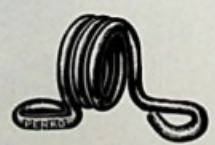

Fig. 932

Fig. 229		Fig. 932		Size Hole Inches	Length Inches	Weight Ounces
Brass Each	Chromium Plated Each	Brass Each	Chromium Plated Each			
\$.12	\$.16	\$.12	\$.16	$\frac{3}{8}$	$1\frac{1}{8}$	$\frac{1}{2}$

Packed per box, 50 pieces.



**Tiller ROPE GUIDES**  
FORGED BRONZE

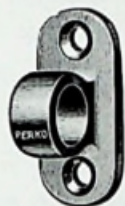

**Fig. 359**

	Dull Bronze Each	Chromium Plated Each	Size Hole Inches	Size Base Inches	Weight Ounces
	\$ .50	\$ .95	$\frac{3}{8}$	$1\frac{1}{8} \times \frac{3}{4}$	$\frac{3}{4}$

Packed per box, 25

**Tiller ROPE GUIDES**  
ZAMAK DIE CASTING—CHROMIUM PLATED



**Fig. 1256**

	Chromium Plated Each	Size Hole Inches	Size Base Inches	For Screw No.	Weight Ounces	Packed Per Box
	\$ .50	$\frac{3}{8}$	$1\frac{1}{2} \times \frac{3}{4}$	6	$\frac{1}{2}$	25

**Tiller ROPE GUIDES**  
ZAMAK DIE CASTING—CHROMIUM PLATED

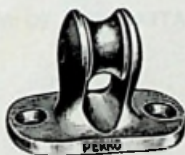

**Fig. 1243**

	Chromium Plated Each	For Diam. Rope Inches	Size Base Inches	For Screw No.	Weight Ounces	Packed Per Box
	\$1.10	$\frac{1}{4}$	$2 \times \frac{3}{4}$	8	$1\frac{1}{4}$	25

**Tiller ROPE GUIDES**  
FORGED BRONZE



**Upright Fig. 593**

Fig.	Dull Bronze Each	Polished Bronze Each	Chromium Plated Each	For Diam. Rope Inches	Size Base Inches	Wt. Ozs.
593	\$ .80	\$1.10	\$1.25	$\frac{1}{4}$	$1\frac{1}{8} \times \frac{1}{8}$	$2\frac{1}{4}$
594	1.00	1.35	1.65	$\frac{1}{4}$	$2\frac{1}{8} \times \frac{3}{8}$	$2\frac{1}{4}$

Drilled for No. 8 screw—Packed 12 pieces per box.



**Side Fig. 594**

**Tiller ROPE GUIDES**  
GALVANIZED CAST IRON OR BRONZE  
OVAL PLATE



**Fig. 599**

No.	Galv. Iron Each	Plain Bronze Each	Chromium Plated Each	Size Hole Inches	Size Base Inches
1		\$ .50	\$ .95	$\frac{3}{8}$	$1\frac{1}{8} \times \frac{7}{8}$
2	\$ .30			$\frac{1}{2}$	$1\frac{1}{2} \times \frac{3}{4}$

Packed per box, 25

**Tiller ROPE GUIDES**  
ZAMAK DIE CASTING—CHROMIUM PLATED



**Fig. 1261**

	Chromium Plated Each	Size Hole Inches	Size Base Inches	For Screw No.	Weight Ounces	Packed Per Box
	\$ .50	$\frac{3}{8}$	$1\frac{1}{2} \times \frac{3}{4}$	6	$\frac{1}{2}$	25

**New COAMING PULLEYS**  
ZAMAK DIE CASTING—CHROMIUM PLATED  
WHITE NYLON SHEAVE



**Fig. 1255**

No.	Each	Diam. Sheave Inches	For Diam. Rope Inches	Dimensions of Plate Inches	For Screw No.	Weight Ounces
1	\$1.20	$1\frac{1}{4}$	$\frac{3}{8}$	$3\frac{1}{2} \times 1\frac{3}{8}$	10	2
2	1.35	$2\frac{3}{8}$	$\frac{3}{8}$	$4\frac{1}{8} \times 1\frac{1}{4}$	10	$2\frac{1}{2}$

**COAMING PULLEYS**

CAST BRONZE OR CAST ALUMINUM  
WITH NYLON SHEAVE



**Fig. 617**

No.	Polished Aluminum Each	Burnished Bronze Each	Chromium Plated Each	Diam. Sheave Inches	For Diam. Rope Inches	Dimensions of Plate Inches	For No. Screw	Weight Bronze Ounces
1	\$1.90	\$1.75	\$2.35	$1\frac{1}{4}$	$\frac{3}{8}$	$3\frac{1}{8} \times 1\frac{3}{8}$	10	4
2		2.00	2.85	$2\frac{3}{8}$	$\frac{3}{8}$	$4\frac{1}{4} \times 1\frac{1}{8}$	10	6

1960 #170



**TILLER ROPE PULLEYS**

WITH WHITE NYLON SHEAVE— $1\frac{1}{2}$  INCH DIAMETER SCORE  
FOR TILLER ROPE UP TO  $\frac{3}{8}$  INCH DIAMETER

**NEW—STAINLESS STEEL**  
**18 — 8 GRADE — SWIVEL TYPE**  
**POLISHED**



Fig. 564

Strap has been tested and meets O. B. C. recommended standards.

Complete Each	Length Overall Inches	Diameter Sheave Overall Inches	Length Strap Inches	Weight Ounces	Packed Per Box
\$1.00	3	$1\frac{1}{4}$	$1\frac{1}{8}$	$1\frac{1}{2}$	25

Without strap, deduct \$.13 each.

**ZAMAK DIE CAST BODY, EYE AND STRAP**  
**ALL CHROMIUM PLATED—SWIVEL TYPE**



Fig. 1241

Complete Each	Length Overall Inches	Diam. Sheave Overall Inches	Length Strap Inches	Weight Ounces	Packed Per Box
\$1.10	$3\frac{1}{4}$	$1\frac{1}{4}$	$1\frac{1}{8}$	3	25

Without strap, deduct \$.20 each.

**POLISHED STAINLESS STEEL BODY**  
**CHROMIUM PLATED ZAMAK STRAP**  
**SWINGING—NON-SWIVEL TYPE**

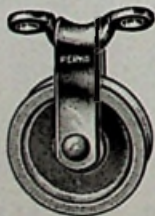

Fig. 551

Complete Each	Length Overall Inches	Diam. Sheave Overall Inches	Length Strap Inches	Weight Ounces	Packed Per Box
\$ .50	$2\frac{1}{2}$	$1\frac{1}{4}$	$1\frac{1}{8}$	$1\frac{1}{2}$	25

**NEW—ALL BRASS**  
**S.S. PIN — SWIVEL TYPE**  
**BRIGHT FINISH**



Fig. 552



Fig. 553

Strap has been tested and meets O. B. C. requirements.

Fig.	Complete Each	Diameter Sheave Overall Inches	Length Overall Inches	Length Strap Inches	Weight Ounces	Packed Per Box
552	\$ .90	$1\frac{1}{4}$	3	$1\frac{1}{8}$	$1\frac{1}{4}$	25
553	1.00	$2\frac{3}{8}$	$3\frac{3}{4}$	$1\frac{1}{8}$	2	25

Diameter score of sheave Fig. 553 is 2 inches.

Without strap, deduct \$.11 each.

**SWIVEL SNAP TYPE**  
**FOR ATTACHING TO MOTOR**



Length Overall Inches	Snap Throat Opening Inches	Diam. Sheave Overall Inches	Weight Ounces	Packed Per Box
$4\frac{1}{4}$	$\frac{1}{2}$	$1\frac{1}{4}$	$3\frac{1}{2}$	25

Fig. 611 — \$1.45 each

Has polished stainless steel body with chromium plated Zamak die cast snap tested to 630 pounds.

Fig. 1288 — \$1.60 each

Has chromium plated Zamak die cast body and snap tested to 630 pounds.



## O. B. C. RECOMMENDED SIZE TILLER ROPE PULLEYS

WITH WHITE NYLON SHEAVE—2 INCH DIAMETER SCORE  
FOR TILLER ROPE UP TO 3/8 INCH DIAMETER

**NEW—STAINLESS STEEL**  
**18 — 8 GRADE — SWIVEL TYPE**  
**POLISHED**



**Fig. 565**

Strap has been tested and meets O. B. C. requirements.

Complete Each	Length Overall Inches	Diameter Sheave Overall Inches	Length Strap Inches	Weight Ounces	Packed Per Box
\$1.10	3 3/4	2 3/8	1 3/8	2	25

Without strap, deduct \$.13 each.

**CHROMIUM PLATED ZAMAK DIE CASTINGS**  
**SWIVEL TYPE—WITH STRAP**

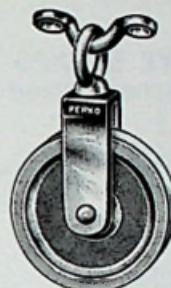

**Fig. 1277**

Complete Each	Length Overall Inches	Diam. Sheave Overall Inches	Weight Ounces	Length Strap Inches	Packed Per Box
\$1.40	4	2 3/8	3	1 3/8	25

Without strap, deduct \$.20 each.

**CHROMIUM PLATED ZAMAK DIE CASTINGS**  
**SWIVEL TYPE—WITH SNAP**

**POLISHED STAINLESS STEEL BODY**  
**WITH CHROMIUM PLATED ZAMAK SNAP**  
**SWIVEL TYPE**

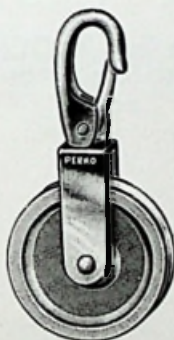

**Fig. 634**

Complete Each	Length Overall Inches	Snap Throat Opening Inches	Diam. Sheave Overall Inches	Weight Ounces	Packed Per Box
\$1.50	4 3/4	1/2	2 3/8	3	25

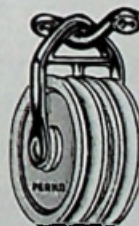

**Fig. 1287**

Complete Each	Length Overall Inches	Snap Throat Opening Inches	Diam. Sheave Overall Inches	Weight Ounces	Packed Per Box
\$1.85	5	1/2	2 3/8	4	25

Snap tested to 630 pounds.

**DOUBLE WHITE NYLON SHEAVES**  
**CHROMIUM PLATED ZAMAK BODY AND STRAP**

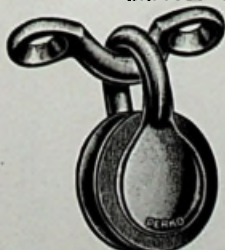

**Fig. 1216**

No.	Complete Each	Length Overall Inches	Diam. Sheave Overall Inches	Length Strap Inches	Weight Ounces	Packed Per Box
1	\$1.35	3 3/8	1 3/4	1 3/8	2 1/2	25
2	1.50	3 3/4	2 3/8	1 3/8	2 3/4	20

Without strap, deduct \$.20 each.

**Economy TILLER ROPE PULLEY**  
**FORGED BRONZE BODY AND STRAP**  
**IMPACT TESTED PLASTIC SHEAVE**



**Fig. 579**

Natural Finish Each	Length Pulley Inches	Size Sheave Inches
\$ .75	1 3/8	1 1/8 x 3/8

Length Strap Inches	For Diam. Rope Inches	Weight Ounces
1 3/8	1/4	1 3/4

Without strap, deduct \$.20 each.



## EYE STRAPS BRASS OR 18-8 STAINLESS STEEL



Fig. 562

Brass Each	Stainless Steel Each	Length Inches	Size Eye Inches	For Screw No.	Weight Ounces	Packed Per Box
\$ .11	\$ .13	1 3/8	1/4	8	1/8	50

## EYE STRAPS ZAMAK DIE CASTING—CHROMIUM PLATED



Fig. 1242

Chromium Plated Each	Length Inches	Size Eye Inches	Stock in Eye Inches	For Screw No.	Weight Ounces	Packed Per Box
\$ .20	1 3/8	3/8	1/4	8	1/4	50

## EYE STRAPS FORGED BRONZE



Fig. 881

No.	Natural Bronze Each	Chromium Plated Each	Length Inches	Size Eye Inches	Stock in Eye Inches	For Screw No.	Wt. Ozs.
0	\$ .25	\$ .50	1 3/8	3/8	1/4	8	1/2
1	.35	.60	2 1/4	3/8	3/2	10	3/4
2	.40	.75	2 3/4	1/2	3/8	10	1 1/2

Packed per box, Nos. 0 and 1, 50 pcs. No. 2, 25 pcs.

## DECK STRAPS CAST BRONZE



Fig. 882

No.	Burnished Bronze Each	Polished Bronze Each	Chromium Plated Each	Length Inches	Size Eye Inches	Stock in Eye Inches	Wt. Ozs.
1	\$ .80	\$ 1.30	\$ 1.60	3 1/2	1/2	3/8	1 1/2
2	1.00	1.80	2.20	4 1/4	3/8	3/8	2 1/2

Packed per box, No. 1, 25 pcs. No. 2, 10 pcs.

## FLANGE EYES CAST BRONZE



Fig. 877

Size No.	Plain Bronze Each	Polished Bronze Each	Polished Chromium Plated Each	Size Opening Inches	Size Base Inches	Weight Ounces
1	\$ .35	\$ .70	\$ .95	3/4	2 1/4 x 1 3/16	1
2	.65	1.10	1.35	3/4	2 1/4 x 1 3/16	2

## Fast Eye BLOCKS GALVANIZED MALLEABLE IRON OR BRONZE

Single  
Without Becket      With Becket Galv. Only



Fig. 43



Fig. 54

Size No.	Galv. Each Fig. 43	Galv. Each Fig. 54	Plain Bronze Each Fig. 43	For Diam. Rope Inches	Size Sheaves Inches	Weight Pounds Each
1	\$ .32	\$ .40	\$ .55	3/8	3/4 x 3/8	3/2
3	.43	.55	.70	1/4	1 x 3/8	3/6
5	.54	.65	1.30	3/8	1 3/8 x 3/8	1/4
7	.70	.95	1.45	3/8	1 1/2 x 1/2	3/8
9	.95	1.30	2.00	3/8	1 3/4 x 3/8	1/2
11	1.35	1.65	2.40	1/2	2 x 5/8	3/8
13	2.20			3/8	2 1/2 x 3/4	1 3/8
15	3.35			3/4	3 x 7/8	1 3/8

NOTE—Blocks with becket supplied only in galvanized.

## Fast Eye BLOCKS GALVANIZED MALLEABLE IRON OR BRONZE

DOUBLE  
Without Becket      With Becket Galv. Only

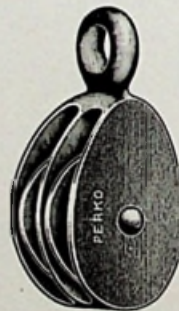

Fig. 51



Fig. 55

Size No.	Galv. Each Fig. 51	Galv. Each Fig. 55	Plain Bronze Each Fig. 51	For Diam. Rope Inches	Size Sheaves Inches	Weight Pounds Each
2	\$ .55	\$ .65		3/8	3/4 x 3/8	3/8
4	.70	.95		1/4	1 x 3/8	1/4
6	1.00	1.30	\$ 2.25	3/8	1 3/8 x 3/8	3/8
8	1.25	1.40	3.45	3/8	1 1/2 x 1/2	3/8
10	1.45	1.85		3/8	1 3/4 x 3/8	3/4
12	1.95	3.10		1/2	2 x 5/8	1 1/4
14	3.45	5.50		3/8	2 1/2 x 3/4	2 3/8
16	7.00	8.10		3/4	3 x 7/8	2 3/4

NOTE—Blocks with becket supplied only in galvanized.



**Swivel Eye BLOCKS**

GALVANIZED MALLEABLE IRON OR BRONZE

SINGLE



Fig. 100

Size No.	For Diam. Rope Inches	Length Shell Inches	Diameter Sheave Inches	Weight Per Doz. in Lbs.
0	3/16	1	1/2	1 1/2
1	3/16	1 1/4	3/4	1 1/4
3	1/4	1 3/4	1	2
5	3/16	2	1 3/8	2 3/8
7	3/8	2 1/4	1 1/2	4 3/8

Size No.	Galvanized Iron Each	Plain Bronze Each
0	\$ .40	\$1.40
1	.50	1.45
3	.68	1.90
5	1.00	2.30
7	1.15	2.65

**Swivel Eye BLOCKS**

GALVANIZED MALLEABLE IRON OR BRONZE

Double

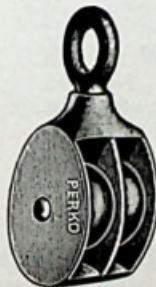

Fig. 101

Size No.	For Diam. Rope Inches	Length Shell Inches	Diameter Sheave Inches	Weight Per Doz. in Lbs.
00	3/16	1	1/2	1 1/8
2	3/16	1 1/4	3/4	2 1/4
4	1/4	1 3/4	1	3 3/8
6	3/16	2	1 3/8	4 1/2
8	3/8	2 1/4	1 1/2	7

Size No.	Galvanized Iron Each	Plain Bronze Each
00	\$ .70	\$1.90
2	.80	2.10
4	1.00	2.65
6	1.35	
8	2.00	

**BLOCKS on Plates**

MALLEABLE IRON OR BRONZE



Fig. 107

Size No.	Cadmium Plated Each	Plain Bronze Each	For Diam. Rope Inches	Style Block	Weight Per 100 in Lbs.
3	\$1.45	\$3.45	1/4	Swivel Eye	31
5	1.55	4.10	3/16	Swivel Eye	47
7	1.75	4.95	3/8	Swivel Eye	75
9	3.35		1/2	Fast Eye	100

**DECK BLOCKS**

OPEN PATTERN  
GALVANIZED IRON OR BRONZE  
SINGLE

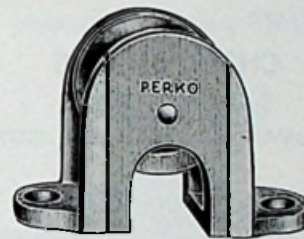

Fig. 87

Size No.	Mall. Iron Each	Cast Iron Each	Plain Bronze Each	For Diam. Rope Inches	Size of Sheave Inches	Weight Pounds
0	\$ .57	\$ .52	\$1.25	3/16	1 3/8 x 3/16	3/8
1	.88	.58	1.75	3/16	1 1/2 x 1/2	3/8
3	1.60	1.10	3.25	1/2	2 x 5/8	1 1/8
5	2.90	2.20	5.10	3/4	2 1/2 x 3/4	1 3/8
7	4.50	3.50	6.40	3/4	3 x 3/4	2 3/8

Cast iron furnished unless otherwise specified.

**DECK BLOCKS**

OPEN PATTERN  
GALVANIZED IRON OR BRONZE  
DOUBLE

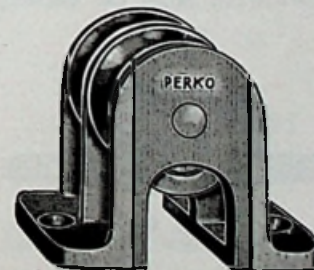
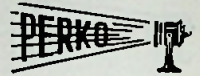

Fig. 88

Size No.	Mall. Iron Each	Cast Iron Each	Plain Bronze Each	For Diam. Rope Inches	Size Sheave Inches
2	\$1.55	\$1.05	\$2.85	3/8	1 1/2 x 1/2
4	2.90	2.20		1/2	2 x 3/8
6	4.65			5/8	2 1/2 x 3/4
8	6.95			3/4	3 x 3/4

Cast iron furnished unless otherwise specified.



**DECK BLOCKS**  
FOR WIRE ROPE  
GALVANIZED MALLEABLE IRON

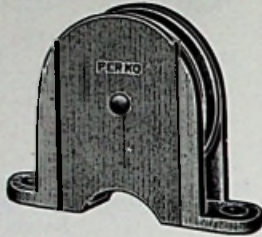

Fig. 139

Size No.	Each	For Diam. Rope Inches	Size Sheave Inches	Weight Pounds
1	\$1.60	1/4	2 x 3/8	3/8
2	2.75	3/8	3 x 5/8	1 1/8
3	4.50	3/4	4 x 3/4	3

**CHEEK BLOCKS**  
FOR WIRE ROPE  
GALVANIZED MALLEABLE IRON



Fig. 140

Size No.	Each	For Diam. Rope Inches	Size Sheave Inches	Weight Pounds
1	\$1.30	1/4	2 x 3/8	3/8
2	2.00	3/8	3 x 5/8	1 1/8
3	3.35	3/4	4 x 3/4	2 3/4

**CHEEK BLOCKS**  
GALVANIZED IRON OR BRONZE  
SINGLE



Fig. 95

Size No.	Galv. Cast Iron Each	Plain Bronze Each	For Diam. Rope Inches	Size Sheave Inches	Weight Pounds
0	\$.75	\$1.40	1/4	1 1/8 x 3/8	3/8
1	.80	1.80	3/8	1 3/8 x 1/2	1/4
2	.88		3/8	1 1/2 x 1/2	3/8
3	1.25		1/2	2 x 5/8	3/4
4	2.60		3/4	2 1/2 x 3/4	1 1/4
5	3.90		3/4	3 x 3/4	2
6	6.60		3/4	3 1/2 x 1	4

**Wire Rope PULLEYS**  
GALVANIZED MALLEABLE IRON OR BRONZE  
UPRIGHT PATTERN

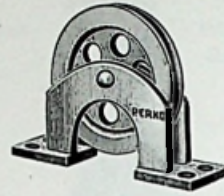

Fig. 279  
SINGLE

Size No.	Galv. Each	Plain Bronze Each	For Diam. Rope Inches	Size Sheave Inches	Weight Pounds
10	\$2.35		3/16	2 1/2 x 3/8	5/8
20	2.80		1/4	3 1/4 x 1/2	1 1/2
30	4.15	\$9.50	5/16-3/8	4 1/2 x 3/8	2 1/2

Fig. 280  
DOUBLE

Size No.	Galv. Each	Plain Bronze Each	For Diam. Rope Inches	Size Sheave Inches	Weight Pounds
110	\$3.50	\$ 6.45	3/16	2 1/2 x 3/8	1 1/8
120	3.95	8.30	1/4	3 1/4 x 1/2	2
130	6.65	15.30	3/16-3/8	4 1/2 x 3/8	4 3/4

**Wire Rope PULLEYS**  
GALVANIZED MALLEABLE IRON OR BRONZE  
SIDE PATTERN



Fig. 194  
SINGLE

Size No.	Galv. Each	Plain Bronze Each	For Diam. Rope Inches	Size Sheave Inches	Weight Pounds
1	\$2.35		3/16	2 1/2 x 3/8	1/2
2	2.80		1/4	3 1/4 x 1/2	1 1/4
3	4.15	\$9.50	3/16-3/8	4 1/2 x 3/8	2 1/2

Fig. 195  
DOUBLE

Size No.	Galv. Each	Plain Bronze Each	For Diam. Rope Inches	Size Sheave Inches	Weight Pounds
11	\$3.50		3/16	2 1/2 x 3/8	1 1/8
12	3.95		1/4	3 1/4 x 1/2	2
13	6.65	\$15.30	3/16-3/8	4 1/2 x 3/8	4 1/4

**CHEEK BLOCKS**  
GALVANIZED IRON  
DOUBLE



Fig. 96

Size No.	Galv. Cast Iron Each	For Diam. Rope Inches	Size Sheave Inches	Weight Pounds
11	\$1.40	3/16	1 3/8 x 3/8	1/2
12	1.50	3/8	1 1/2 x 1/2	1 1/8
13	2.55	1/2	2 x 3/8	1 1/2





## RINGS

POLISHED BRASS



Fig. 417

Inside Diam. Inches	Thick-ness Inches	Per Dozen	Inside Diam. Inches	Thick-ness Inches	Per Dozen
1/2	3/32	\$1.35	1 1/4	3/16	\$3.25
5/8	3/32	1.50	1 1/2	7/32	4.45
3/4	3/32	1.75	1 3/4	1/2	6.10
7/8	3/32	2.15	2	1/4	7.15
1	3/32	2.60			

## Dock Line SPRINGS

STEEL-ZINC PLATED



Fig. 759

A very strong compression spring for dock and mooring lines. It cushions the strain and contributes greatly to the life of the line.

Size No. 1 will accommodate 1/2 inch diameter rope, No. 2 for 3/4 inch rope.

No.	Each	Length Overall Inches	Diameter Spring Inches	Diameter Metal Inches	Compression Inches	Weight Pounds
1	\$1.40	10	1 1/2	3/16	4 1/2	7/8
2	4.40	18	2	1/4	8	2 3/4

## ASSORTED SHEAVES

BRONZE OR NYLON

COMMON BUSHED—FOR MANILA ROPE



Fig. 154

BRONZE

No.	Each	Diam. Inches	Thickness Inches	For Rope Inches	For Size Pin Inches
10	\$.45	3/8	3/8	3/8	1/32

WHITE NYLON

27	\$.30	1 1/4	7/16	3/8	1/4
28	.40	2 3/8	7/16	3/8	1/4

## Assorted Brass PINS

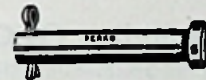

Fig. 1176

No.	Each	Diam. Pin Inches	Length Under Head Inches	Diam. Head Inches	Type Head
1	\$.30	3/8	3/8	1/4	Flat
2	.30	3/8	3/4	1/4	Flat
4	.34	3/8	1	1/4	Flat
5	.34	1/4	5/8	3/16	Round
6	.36	1/4	3/4	3/16	Flat
7	.38	1/4	7/8	3/16	Flat
8	.42	1/4	1 1/8	3/16	Flat
10	.42	1/4	1 1/4	3/16	Flat
11	.42	3/8	7/8	3/8	Flat
15	.44	3/8	1 1/4	3/8	Flat
16	.44	3/8	1 1/2	3/8	Flat
18	.58	3/8	1 5/8	3/8	Flat
27	.90	1/2	1 1/4	3/8	Flat
28	.95	1/2	1 1/2	3/8	Flat

## Anchor LIFT LEADERS

GALVANIZED MALLEABLE IRON



Fig. 483

For attaching to bow of boat. The sheave projects over the stem. These are very handy for raising or dropping anchor.

Each	For Diam. Rope Inches	Size Sheave Inches	Length Overall Inches	Length Plate Inches	Weight Pounds
\$2.25	3/8	2x1/2	7 1/2	4 1/2	1 1/4

## BELAYING PINS

GALVANIZED MALLEABLE IRON

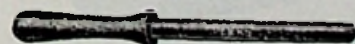

Fig. 366

Diam. Shank Inches	Galv. Each	Length Head Inches	Extreme Length Inches	Weight Each Pounds
3/8	\$1.35	3	8	3/8
1/2	2.10	3 3/8	9 1/2	3/4
3/8	2.60	3 3/4	10 1/4	1
3/4	3.10	4 1/4	11	1 3/4



## Sliding Adjustable GOOSENECK CAST MANGANESE BRONZE

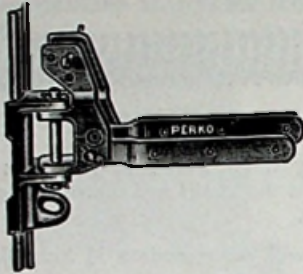

Fig. 915

Has three positions for tack of sail, two positions for boom. Ideal and universal for most small boats. Will accommodate booms up to 1 1/4 inches thick if necessary.

Burnished Each	For Track Inches	For Boom Thickness Inches	Length Inside Straps Inches	Weight Ounces
\$6.90	3/8	3/4 or 7/8	4 3/4	12

## Lightweight Sliding GOOSENECKS CAST BRONZE—BURNISHED

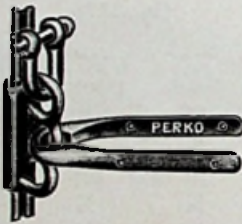

Fig. 916

Straps are adjustable for booms of various thickness. Track not included.

Each	For Track Inches	For Boom Thickness Inches	Length Inside Straps Inches	Weight Ounces
\$4.30	3/8	up to 1 1/4	3 1/2	8

## Bronze WIRE ROPE SOCKETS CAST BRONZE—BURNISHED CLOSED TYPE



Fig. 756

No.	Each	Diam. Wire Inches	Width Inside Inches	Length Overall Inches	Weight Ounces
00	\$ .85	1/16	3/8	1 3/4	1
0	.85	3/32	3/8	1 3/4	1
1	.95	1/8	3/8	1 3/4	1
2	1.10	3/16	1/2	2 1/4	2
4	2.00	3/16	3/4	3	4 1/2
5	2.55	3/8	1	3 1/4	8

## WIND PENNANTS

ADJUSTABLE COUNTERBALANCE  
ALUMINUM PENNANT—BRASS STANDARD

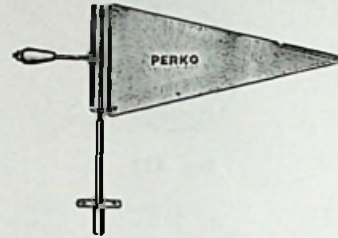

Fig. 435

Pennant swings on a needle point pivot and has an adjustable counterbalance should the weight of the pennant change from the application of paint or attachments of any kind.

Perfect balance and needle point bearing makes this pennant instantly responsive to the lightest of winds.

Furnished in Painted Finish, Red or Blue

For Mast 1 Inch Diam. at Top, 5/16" Role

No.	Each	Size of Pennant Inches	Height Overall Inches	Weight Ounces
1	\$5.25	6 1/2 x 3	6 1/2	2 1/2
2	5.90	9 1/2 x 4 1/2	7 3/4	4

WITH HORIZONTAL VANE

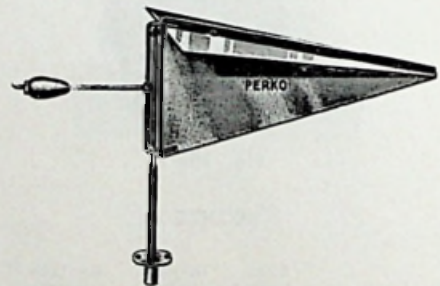

Fig. 837

This is the same as our popular Fig. 435 wind pennant improved by the addition of a horizontal vane attached to the regular vertical vane permitting a more distinct view when directly below the pennant. The horizontal vane is detachable if not required.

Furnished in painted finish, either red or blue.

No.	Complete Each	Size of Pennant Inches	Height Overall Inches	Weight Ounces
5	\$6.00	6 1/2 x 3	6 1/2	3
6	7.25	9 1/4 x 4 1/2	7 3/4	5

## THRU-DECK FAIRLEADERS BRONZE



Fig. 891

Size No.	Bright Finish Each	Inside Hole Inches	Outside Diam. Flange Inches	For Screw No.	Weight Ounces	Packed Per Box
1	\$ .40	3/8	1 1/2	6	3 1/2	12
2	.40	1/2	1 1/2	6	1 1/2	12



**PAINT SCRAPER SET**

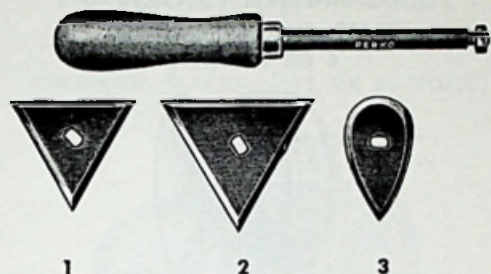

Fig. 1015

Per Set — \$3.60

Set consists of handle with 3 blades illustrated, and nut to change and attach blades.

Packed, 1 set to a box.

No. 1 Blade, Triangular— $2\frac{3}{8} \times 2\frac{3}{8}$  inches.

No. 2 Blade, Triangular— $3 \times 3$  inches.

No. 3 Blade, Oval— $2\frac{1}{2} \times 1\frac{1}{4}$  inches.

Length Handle— $8\frac{1}{2}$  inches.

Weight Per Set, 9 Ounces.

**DOUBLE END SCRAPERS**  
FINE GRADE TOOL STEEL  
HEAT TREATED

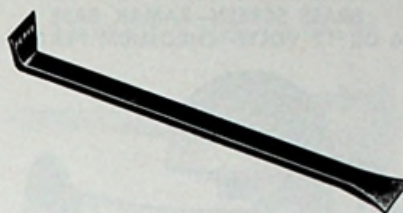

Fig. 1175

Per Doz.	Length Inches	Width Inches	Thickness Inches	Width Blade Inches	Weight Per Dozen Pounds
\$12.00	15	1	$\frac{1}{4}$	$1\frac{1}{2}$	13

**MARLINE SPIKES**  
POLISHED STEEL  
FOR WIRE ROPE

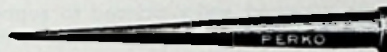

Fig. 921

Length Inches	Each	Weight Pounds
8	\$4.85	$\frac{1}{2}$
10	5.25	$\frac{3}{8}$
12	5.75	1
14	6.30	$1\frac{1}{4}$
16	6.85	2
18	8.25	$2\frac{1}{2}$

**CAULKING IRONS**

MALLEABLE IRON



Fig. 307

Size No.	Per Dozen	Thickness Inches	Length Inches	Width Blade Inches	Weight Per Dozen in Lbs.
00	\$22.50	$\frac{1}{2}$	5	2	$3\frac{1}{2}$
0	22.50	$\frac{3}{8}$	$5\frac{1}{4}$	$2\frac{1}{2}$	$4\frac{1}{2}$
1	24.00	$\frac{1}{8}$	$5\frac{1}{8}$	$2\frac{1}{4}$	$5\frac{1}{4}$

FOR MANILA ROPE

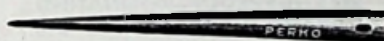

Fig. 922

Length Inches	Each	Weight Pounds
6	\$1.90	$\frac{1}{2}$
8	1.90	$\frac{3}{4}$
10	2.10	1
12	2.60	$1\frac{1}{2}$
14	3.20	2
16	4.00	$2\frac{1}{4}$
18	5.25	3

**HAND FIDS**  
MAPLE

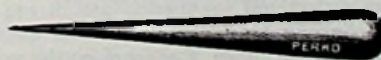

Fig. 923

For use in splicing ropes and light flexible cables, has a rounded end for hand use; varnished finish.

No.	Per Dozen	Size Inches	Weight Per Dozen Pounds
0	\$13.00	$12 \times 1\frac{3}{4}$	$4\frac{1}{2}$
1	16.00	$14 \times 1\frac{3}{4}$	$4\frac{1}{2}$
2	17.25	$16 \times 2$	6
3	20.00	$18 \times 2$	$7\frac{1}{2}$
4	30.00	$20 \times 2\frac{1}{4}$	$10\frac{1}{2}$
5	53.50	$24 \times 3$	18

**Sail Makers PALMS**  
HIDE MOUNTED—BRONZE SPINDLE  
RIGHT HAND ONLY



Fig. 411

Seaming—Half Hide ..... Per Dozen \$13.50



**"Sea Echo" HORN**  
**BRASS COVER AND PROJECTOR**  
**BRASS SCREEN—ZAMAK BASE**  
**6 OR 12 VOLTS—CHROMIUM PLATED**

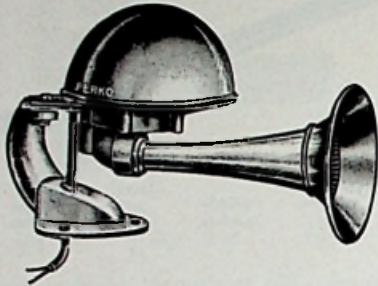

Fig. 590

A very loud resonating horn with short projector and a brass chromium plated screen in the mouth of the projector.

This horn is designed and produced to supply a long felt need for a combination of loud, distinctive tone, short projector and good looks.

Complete with 5½ feet of cable and push button.

Volts	Each	Length Overall Inches	Height Overall Inches	Weight Pounds
6	\$41.50	10¾	7⅞	4¼
12	42.20	10¾	7⅞	4¼

**"Sea-Tone" HORN**  
**ALL BRASS—CHROMIUM PLATED—WATERTIGHT**  
**WEATHERPROOF—RESONATING**  
**VOLTAGES—6—12—32—110 D.C.**  
**RANGE—2 MILES**

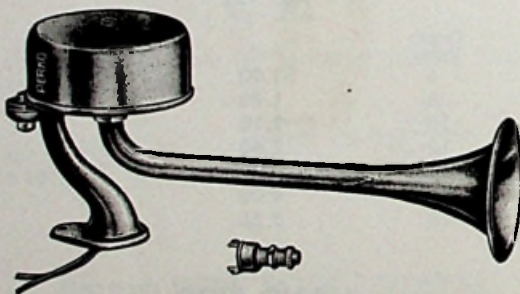

Fig. 576

A horn manufactured for marine use. It has great volume and distinctive tone. It answers the demand for a high quality marine horn that can be heard at great distance and stand the arduous test of use on salt water.

Supplied complete with heavy duty push button and 16 feet of cable in two eight-foot lengths.

Volts	Each	Extreme Length Inches	Extreme Height Inches	Weight Pounds
6	\$ 92.50	19	8½	6½
12	92.50	19	8½	6½
32	92.50	19	8½	6½
110 D.C.	112.00	19	8½	6½

110 A.C. supplied to order, price on application.

Packed in individual cartons.

**"Sea-Pitch" HORN**  
**BRASS—CHROMIUM PLATED**  
**6 OR 12 VOLTS**

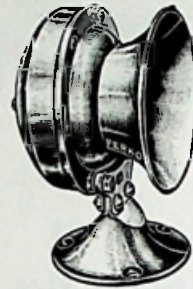

Fig. 1121

A horn designed to meet the need for a brass horn made for marine use at a price that every small boat owner can afford. Has a very loud tone that can be heard at a great distance.

The diaphragm is cadmium plated, salt spray tested.

6 Volt Each	12 Volt Each	Length Overall Inches	Height Overall Inches	Diam. Base Inches	Weight Pounds
\$26.75	\$26.75	5	7¼	3¾	3½

**Marine SIRENS**  
**DIE CAST BODY AND BASE**  
**CHROMIUM PLATED—6 OR 12 VOLTS**  
**THE SEA-MITE**

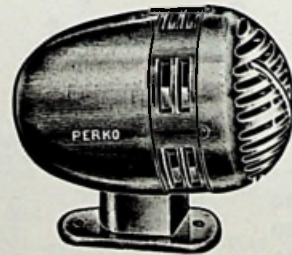

Fig. 1117

A siren of fine tone quality, dependability and performance.

Furnished complete with 10 feet of cable and heavy duty push button.

6 Volt Each	12 Volt Each	Length Inches	Height Inches	Diam. Inches	Weight Pounds
\$50.00	\$50.00	7	6	4½	4¼

**NOTE**

The "Perko" Freon Sea Horn Fig. 530 has been discontinued but refills are still available. \$1.75 ea.



## Heavy Duty Marine SIREN

DIE CAST BODY AND BASE  
CHROMIUM PLATED—6, 12 OR 32 VOLTS

### THE YACHTSMAN

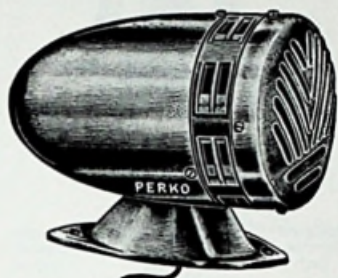

Fig. 1118

A siren that audibly commands the right of way. An ear-piercing tone that can be heard for miles.

Has specially designed motor for economical operation. Equipped with greased sealed ball bearings for smooth operation.

Furnished complete with long cable and heavy duty push button.

6 Volt Each	12 Volt Each	32 Volt Each	Length Inches	Height Inches	Diam. Inches	Weight Pounds
\$90.00	\$90.00	\$95.50	10 $\frac{1}{8}$	7 $\frac{1}{2}$	5 $\frac{3}{4}$	10

## Horn PUSH BUTTON



Fig. 275

BRASS — CHROMIUM PLATED  
BAKELITE BUTTON AND INTERIOR

Chromium Plated Each	Length Overall Inches	C to C Holes Inches	Diam. Inches	Weight Ounces
\$1.00	2 $\frac{3}{8}$	2 $\frac{1}{8}$	1 $\frac{1}{2}$	1

## Watertight PUSH BUTTONS

CAST BRONZE



Fig. 978

With nickel silver springs, platinum contacts, rubber gaskets and pig skin cap over button, with screws.

Polished Bronze Each	Chromium Plated Each	Diam. Base Inches	Weight Ounces
\$7.35	\$9.20	2 $\frac{3}{8}$	6

## FOG HORNS

GALVANIZED STEEL OR BRASS



Fig. 162

Length Overall Inches	Galvanized Steel Per Doz.	Polished Brass Per Doz.
18	\$36.00	\$48.50

## Triplex Motor Boat WHISTLE

PLASTIC—ORANGE COLOR

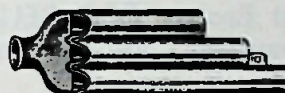

Fig. 167

Per Dozen	Length Overall Inches	Width Overall Inches	Weight Per Dozen Pounds
\$4.80	6	1 $\frac{3}{4}$	1

## Police or Signal WHISTLE

BRASS—NICKEL PLATED



Fig. 349

Per Dozen	Length Inches	Width Inches	Weight Per Doz. Ounces
\$13.80	2	$\frac{3}{4}$	17



## Wrought Brass FOG BELLS

WITH REMOVABLE BRACKET  
PRESSED BELL METAL



Fig. 159

Diameter Inches	Plain Brass Each	Polished Brass Each	Chromium Plated Each	Height Overall Inches	Wt. Lbs.
6	\$ 8.25	\$10.50	\$11.60	4	1
8	11.90	13.80	15.25	5	2½
Wall Plate only	\$ 1.15	\$ 1.50	\$ 1.85		
Arm only	1.90	2.30	2.95		
Clapper only	1.50	2.05	2.75		
Eye Bolt only	.65	.85	1.10		

Wall plate drilled for No. 6 screw.

## Cast Bronze FOG BELLS

MEDIUM WEIGHT—WITH REMOVABLE BRACKET



Fig. 420

Diameter Inches	Polished Bronze Each	Chromium Plated Each	Height Overall Inches	Weight Pounds
6	\$19.50	\$23.00	5	4
8	29.00	34.00	6¾	8

### WALL PLATE ONLY

6	\$2.65	\$3.25	2½	¼
8	2.65	3.25	2½	¼

Drilled for No. 8 screw.

## Cast Bronze FOG BELLS

LIGHTWEIGHT—WITH REMOVABLE BRACKET



Fig. 581

Diameter Inches	Polished Bronze Each	Chromium Plated Each	Height Overall Inches	Weight Pounds
6	\$12.00	\$15.00	4¾	3
8	15.00	19.00	5¾	5
Wall Plate only	1.40	2.10	2	¼

Drilled for No. 8 screw.

## Cast Bronze FOG BELLS

HEAVY WEIGHT—WITH REMOVABLE BRACKET

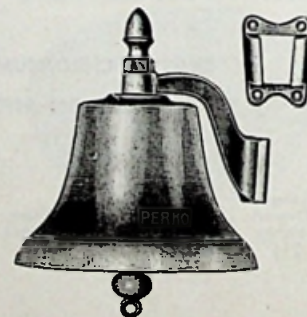

Fig. 150

Diameter Inches	Polished Bronze Each	Chromium Plated Each	Height Overall Inches	Weight Pounds
8	\$ 42.00	\$ 52.00	8	10
10	81.00	91.50	10½	22
12	108.00	121.00	12	38

### WALL PLATE ONLY

8	\$2.65	\$3.25	2½	¼
10	5.00	5.60	3¾	1
12	5.00	5.60	3¾	1

8 inch wall plate No. 8 screw.

10 and 12 inch wall plates for ¼ inch bolt.

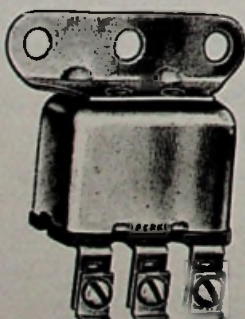
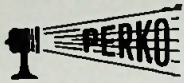

Fig. 273

## RELAYS

Eliminates line loss where electric unit is located some distance from the battery.

6 Volts Each	12 Volts Each
\$2.25	\$2.25



## STREAMLINED MASTS

**CAST ALUMINUM  
HINGED FORWARD**

**PAINTED WHITE ENAMEL  
WITH CLEAT AND EYES FOR HALYARD**

Note the hinged base with large thumb screw to permit instant lowering of the mast when passing under low bridges. All types have a halyard cleat and a glare shield to reduce reflection of range light.

White enamel is our stock finish, but, of course the owner may repaint to suit his own color requirements.

All lengths shown do not indicate the vertical height above deck but are actually the length of the mast.

### STRUCTURAL TYPE WITH 360 DEGREE LIGHT

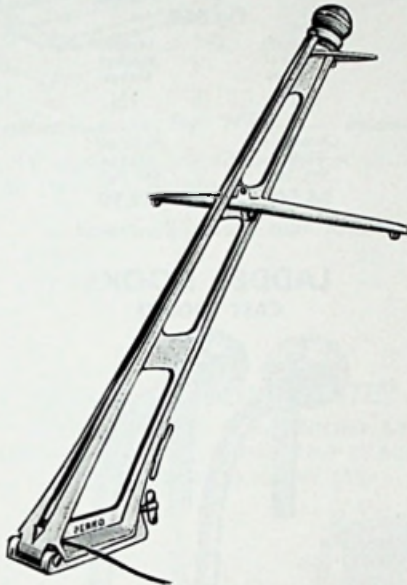

Fig. 37

No.	Each	Length Inches	Dimensions Base Inches	Width Yardarms Inches	Weight Pounds
1	\$55.00	33	7½x3½	23¼	7½
2	74.25	52	9¼x4¼	33¼	13

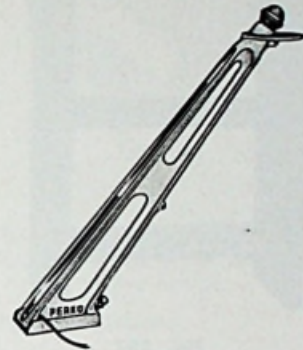

Fig. 47

Each	Length Inches	Dimensions Base Inches	Weight Pounds
\$21.00	22	4½x2¾	2¾

This mast cannot be supplied with yardarm.

### STRUCTURAL TYPE WITH 360 DEGREE AND 225 DEGREE LIGHTS.

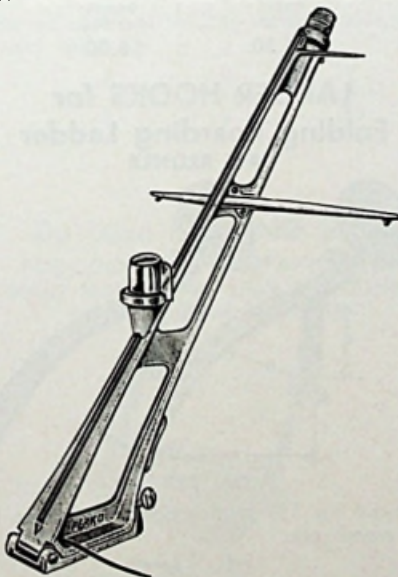

Fig. 40

No.	With Zamak Bow Light Each	With Bronze Bow Light Each	Length Inches	Dimensions Base Inches	Width Yardarms Inches	Weight Pounds
1	\$66.00	\$70.00	33	7½x3½	23¼	7½
2	86.50	90.50	52	9¼x4¼	33¼	13

The 225° bow light is chromium plated.

## Folding STOOLS

VARNISHED SEAT—CAST BRONZE BRACKET



Fig. 1009

No.	Each	Diam. Seat Inches	Projection Inches	Length Bulkhead Bracket Inches	Weight Pounds
1	\$15.00	12	12⅞	11	7
2	16.00	14	15	11	8



## Folding BOARDING LADDERS

### MAHOGANY WITH CAST BRONZE FITTINGS

Made of high quality mahogany, varnished. Supplied complete with plates for hanging and polished bronze or chromium plated fittings.

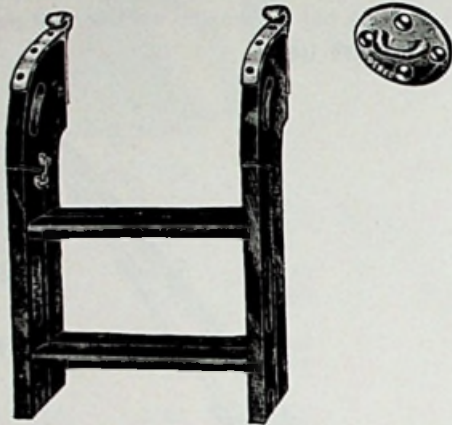

Fig. 557

NO. 1 CLOSED 2 STEPS—OPEN 4 STEPS  
NO. 2 CLOSED 3 STEPS—OPEN 6 STEPS

No.	With Polished Bronze Fittings Each	With Chromium Plated Fittings Each	Overall Length Open Inches	Overall Length Closed Inches	Overall Width Inches	Weight Pounds
1	\$69.50	\$76.00	36	21½	15	9½
2	72.50	79.00	51	30	15	12½

### SPARE PARTS

Hooks and Hanging Plates, See Fig. 717  
Hinges, See Fig. 556  
Cabin Door Hooks, See Fig. 956

## ROPE LADDERS

WITH FLAT ASH STEPS,  
MAHOGANY STAINED, VARNISHED  
½ INCH DIAMETER MANILA ROPE

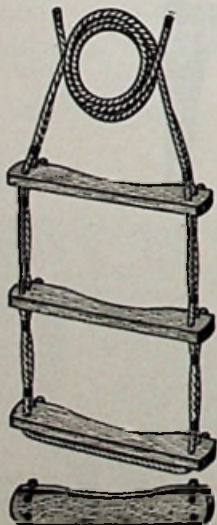

Fig. 992

Steps are 12 inches apart and each has two white rubber bumpers.

Rope has 3 foot loop above top step for hanging.

Dimensions of steps  
15x3¾x¾ inches

Number of Steps	Each
2	\$11.75
3	14.00
4	17.00

Additional steps to order add \$4.75 for each.

## LADDER LOCKS

FOR COMPANIONWAY OR UPPER BERTH  
CAST BRONZE

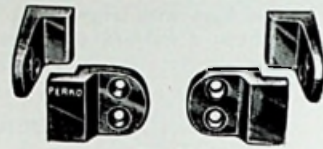

Fig. 669

Height Inches	Length Socket Inches	Length Bracket Inches	Weight Per Set Ounces
1¼	1	1¼	12
Complete		Spare Sockets Only	
Polished Bronze Per Set	Chromium Plated Per Set	Polished Bronze Per Pair	Chromium Plated Per Pair
\$4.75	\$6.50	\$2.90	\$4.00

A set consists of four pieces illustrated.

## LADDER HOOKS CAST BRONZE

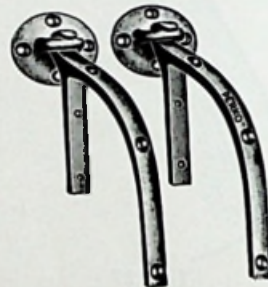

Fig. 670

Extreme Length Inches	Length Brace Inches	Size Plate Inches	Weight Per Set Pounds
12	4	2½x3¼	4
Complete		Plates Only	
Polished Bronze Per Set	Chromium Plated Per Set	Polished Bronze Per Pair	Chromium Plated Per Pair
\$19.50	\$25.50	\$6.00	\$8.00

## LADDER HOOKS for Folding Boarding Ladder CAST BRONZE

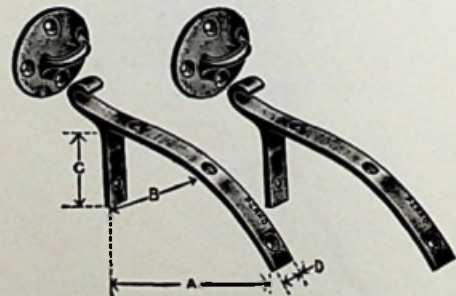

Fig. 717

Used on our Fig. 557 folding boarding ladder. Designed for wide woodwork.

A Inches	B Inches	C Inches	D Inches	Length Curved Arm Inches	Size Plate Inches	Weight Per Set Pounds
6⅞	4	2½	⅞	7	2½x3¼	2½
Complete					Plates Only	
Polished Bronze Per Set	Chromium Plated Per Set	Polished Bronze Per Pair	Chromium Plated Per Pair			
\$18.50	\$23.50	\$6.00	\$8.00			



## Folding FOOT REST HEAVY GAUGE ALUMINUM

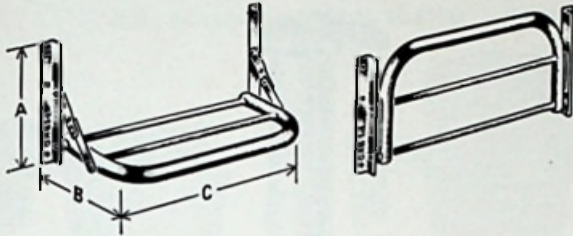

Fig. 967

Folds flat against bulkhead when not in use. Strong enough to stand on if necessary.

No.	Each	A Inches	B Inches	C Inches	Weight Pounds
1	\$10.50	8	8	12	1
2	10.95	8	8	16	1½

## Standard FOLDING STEP FOR COCKPIT OR COMPANIONWAY ALUMINUM FRAME, HINGES AND BRACKETS VARNISHED MAHOGANY STEP

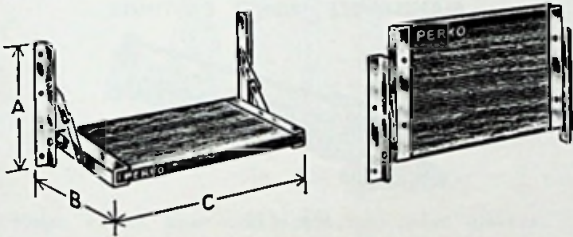

Fig. 543

Also serves as small folding table in cockpit, for ash-trays, drinks, etc.

Each	A Inches	B Inches	C Inches	Weight Pounds
\$15.00	8	9	14	3

## De Luxe FOLDING STEP FOR COCKPIT OR COMPANIONWAY SOLID MAHOGANY—SPAR VARNISHED WHITE RUBBER STEP PAD

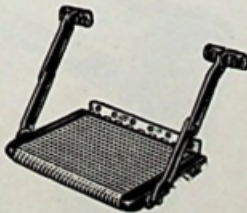

Fig. 602

Supplied complete with hinge and strong folding brackets, all brass, chromium plated.

Complete Each	Spare Folding Brackets Per Pair	Dimensions Step Inches	Thickness Step Inches	Weight Pounds
\$28.50	\$15.00	13¼x9	¾	5½

## BOARDING STEP

CAST BRONZE

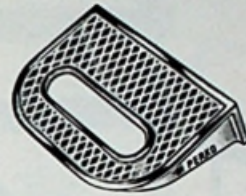

Fig. 351

Designed for mounting on transom, permitting easy access to or from the water or for mounting on bulkhead for climbing to the flying bridge.

All high spots are polished.

Burnished Bronze Each	Chromium Plated Each	Dimensions of Step Inches	Dimensions Mounting Bracket Inches	Weight Pounds
\$5.00	\$6.80	6x4¼	6x2	1⅝

## FOLDING STEP

MANGANESE BRONZE—STAINLESS STEEL SPRING

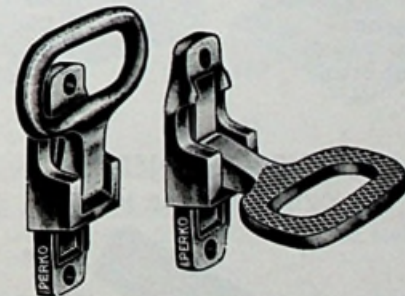

FOLDED

OPEN

Fig. 344

For mounting on hull or transom, folds up out of way when not in use. Spring holds step in position.

Chromium Plated Each	Size Step Inches	Size Base Inches	Extends Folded Inches	Weight Pounds
\$8.50	4x2	4¼x1¾	¾	1⅝



## Swivel FISHING CHAIR MAHOGANY WITH CAST BRONZE FITTINGS DEMOUNTABLE—WITH COVER FOR DECK FLANGE

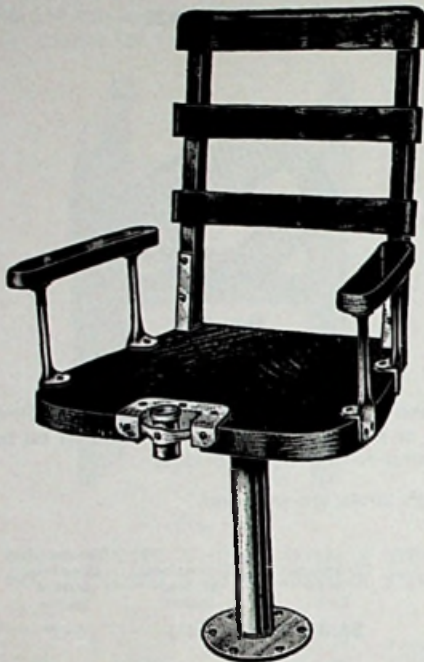

Fig. 559

	With Polished Bronze Fittings Each	With Chromium Plated Fittings Each	Height of Seat Inches	Dimensions of Seat Inches	Diam. Deck Flange Inches	Weight Pounds
	\$160.00	\$175.00	18	19x22	7	45

### SPARE PARTS

No.	No. Per Chair	Polished Bronze Each	Chromium Plated Each
1 Rod Socket Complete	1	\$15.75	\$19.00
2 Seat Flange, Plain	1	10.00	
3 Pedestal—2 inch pipe	1	14.00	17.00
4 Deck Flange Complete	1	16.80	19.00
5 Arm Supports	4	5.00	6.30
6 Back Rest Sockets	2	5.00	6.30
7 Back Rest Brace	1	11.25	13.75

## RUBBER LINERS FOR OUTRIGGER POLE HOLDERS



Fig. 648

Each	Length Inches	Outside Diameter Inches	Inside Diameter Inches	Weight Ounces
\$1.65	9	1 3/4 to 2	1 1/2 to 1 3/4	6 1/2

## Outrigger or FISHING POLE SOCKETS ALL BRASS—CHROMIUM PLATED OR ALL ALUMINUM—POLISHED

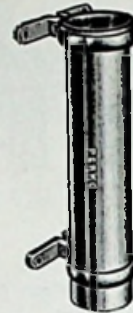

Fig. 1100

No.	Complete Each	Brackets Only Per Pair	Inside Diam. Inches	Length Overall Inches	Width Brackets Inches	Wt. Oz.
1 Aluminum	\$7.40	\$1.85	1 1/8	8 1/4	3 3/8	5 1/2
2 Brass, C.P.	8.65	3.30	1 1/8	9	3	16

## Adjustable OUTRIGGER POLE HOLDERS

HEAVY BRASS TUBING  
MANGANESE BRONZE CASTINGS

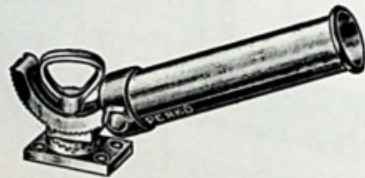

Fig. 475

May be adjusted quickly to any desired angle or position vertically and horizontally. Locked by large thumb bolt illustrated.

Burnished Finish Each	Chromium Plated Each	Inside Diam. Socket Inches	Length Socket Inches	Dimensions Base Inches	Weight Pounds
\$17.50	\$25.00	1 1/8	9 1/2	3 3/8 x 2 1/4	3 3/4

## Gimbal FISHING ROD SOCKETS ALUMINUM—BRIGHT ETCH FINISH

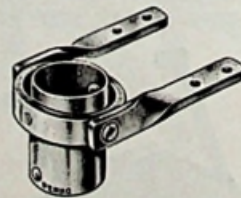

Fig. 481

For attaching to chairs, seats, benches, etc.

Each	Inside Diameter Inches	Length Brackets Inches	Depth Socket Inches	Weight Ounces
\$6.00	1 1/8	2 1/2	2 3/4	7

A pair of aluminum "U" bolts for attaching above socket to tubular chairs is available. Specify Fig. 481-A \$1.10 per pair.



## ASH TRAYS and GLASS HOLDERS

SWINGING TYPE

ALL BRASS—CHROMIUM PLATED

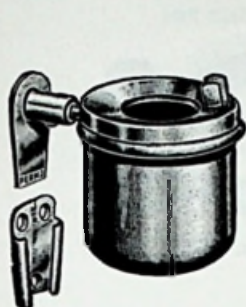

Fig. 798

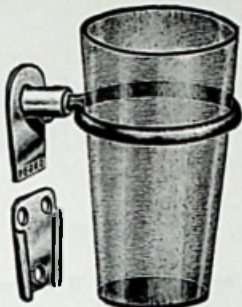

Fig. 799

### BEER CAN HOLDER

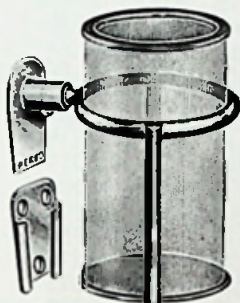

Fig. 804

Holds 12 oz. beer cans or straight sided glasses.

Fig.	Each	Size Mounting Plate Inches	Inside Diam. Ring Inches	Weight Ounces
798	\$7.35	1 3/4 x 1 1/4	2 3/4	13 1/2
799	4.75	1 3/4 x 1 1/4	2 3/4	3 1/2
804	5.00	1 3/4 x 1 1/4	2 3/4	5

Spare Mounting Plates, \$1.75 each.

## ROPE LADDER HOOK

CAST BRONZE

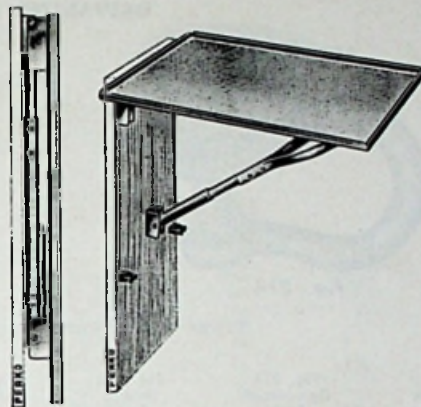

Fig. 817

Burnished Each	Chromium Plated Each	Length Overall Inches	Width Inches	For Screw No.	Packed Per Box	Weight Pounds
\$2.40	\$3.50	3	1 3/4	12	6	1/2

## FOLDING TABLE

ALL ALUMINUM—ANODIZED



Closed

Open

Fig. 977

Just right for small cruisers, sailboats, etc. where space is limited.

Folds down against bulkhead to a space of only 2 1/4 inches. Supplied with clamps to hold in folded position.

Table top has raised edges to prevent dishes sliding off, corners are open for drainage.

Each	Length Top Inches	Width Top Inches	Weight Pounds
\$21.00	24	18	6

## TABLE BRACKETS

18-8 STAINLESS STEEL—POLISHED

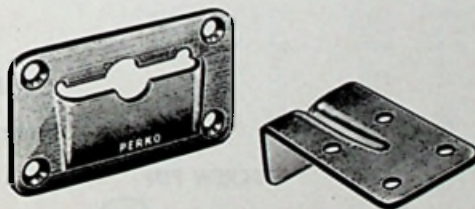

Fig. 148

For removable tables in cabin or cockpit.

A pair of angle brackets attached to table and several pairs of wall plates mounted in cabin and cockpit allows placing of table as desired.

Angle bracket cannot jump out of wall plate when table leg is firmly placed on deck.

Per Set	Angle Brackets Only Per Pair	Wall Plates Only Per Pair
\$5.20	\$2.60	\$2.60

A set consists of 2 brackets and 2 plates.

Dimensions Angle Bracket Inches	Dimensions Wall Plate Inches	Weight Bracket Ounces	Weight Wall Plate Ounces
2 3/4 x 1 1/8	3 3/8 x 2	3	3

60



**ANCHOR SHACKLES**

**GALVANIZED DROP FORGED STEEL OR BRONZE**

**SCREW PIN**

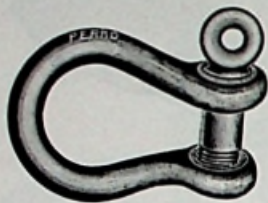

**Fig. 314**

**ROUND PIN**

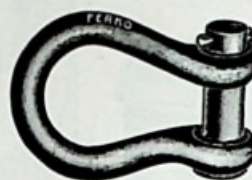

**Fig. 315**

Prices and Dimensions Below Apply to both Figs. 314 and 315.

Size Inches	Fig. 314 Galvanized Each	Fig. 314 Bronze Each	Fig. 315 Galvanized Each	Length Inside Inches	Between Eyes Inches	Diameter Pin Inches	Steel Weight Per 100 in Pounds	Steel Approx. Strength in Pounds
$\frac{3}{16}$	\$ .61	\$1.00		$\frac{3}{8}$	$\frac{3}{16}$	$\frac{1}{4}$	7	2700
$\frac{1}{4}$	.72	1.15	\$ .68	$1\frac{1}{4}$	$\frac{3}{16}$	$\frac{3}{16}$	12	4600
$\frac{5}{16}$	.77	1.45	.79	$1\frac{1}{4}$	$\frac{5}{16}$	$\frac{3}{16}$	20	7000
$\frac{3}{8}$	.89	2.15	.82	$1\frac{1}{2}$	$\frac{3}{8}$	$\frac{3}{16}$	31	8600
$\frac{7}{16}$	1.16	3.20	1.03	$1\frac{3}{4}$	$\frac{3}{4}$	$\frac{1}{2}$	47	12500
$\frac{1}{2}$	1.32	4.20	1.24	2	$\frac{7}{16}$	$\frac{3}{8}$	69	17500
$\frac{5}{8}$	2.16		2.08	$2\frac{1}{2}$	$1\frac{1}{8}$	$\frac{3}{4}$	137	24900
$\frac{3}{4}$	2.98		2.82	$2\frac{3}{4}$	$1\frac{3}{8}$	$\frac{7}{8}$	219	40000
$\frac{7}{8}$	3.84		3.79	3 $\frac{1}{4}$	$1\frac{1}{2}$	1	319	53000
1	5.58			$3\frac{1}{2}$	$1\frac{5}{8}$	$1\frac{1}{8}$	500	61000
$1\frac{1}{8}$	8.03			$4\frac{1}{8}$	$1\frac{7}{8}$	$1\frac{1}{4}$	681	81000
$1\frac{1}{4}$	10.08			$4\frac{1}{4}$	2	$1\frac{3}{8}$	950	85000
$1\frac{3}{8}$	12.45			$5\frac{1}{4}$	$2\frac{1}{8}$	$1\frac{1}{2}$	1218	95000
$1\frac{1}{2}$	16.03			6	$2\frac{1}{2}$	$1\frac{5}{8}$	1625	119000
$1\frac{3}{4}$	22.90			7	$2\frac{3}{4}$	2	2700	192500
2	34.40			8	$3\frac{1}{4}$	$2\frac{1}{4}$	3725	239500

Bronze Shackles are only furnished with screw pin, Fig. 314

Galvanized  $\frac{3}{16}$  inch size supplied only with screw pin, Fig. 314.

**CHAIN SHACKLES**

**GALVANIZED DROP FORGED STEEL**

**SCREW PIN**

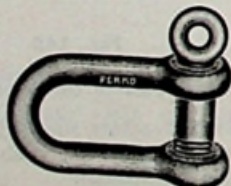

**Fig. 338**

**ROUND PIN**

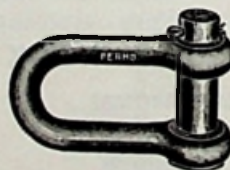

**Fig. 339**

Size Inches	Fig. 338 Each	Fig. 339 Each	Length Inside Inches	Between Eyes Inches	Diameter Pin Inches	Weight Per 100 in Pounds	Approx. Strength in Pounds
$\frac{1}{4}$	\$ .72	\$ .68	$1\frac{1}{16}$	$\frac{3}{16}$	$\frac{5}{16}$	10	4600
$\frac{3}{16}$	.77	.77	1	$\frac{1}{4}$	$\frac{3}{8}$	18	7000
$\frac{1}{8}$	.89	.82	$1\frac{1}{4}$	$\frac{5}{16}$	$\frac{3}{8}$	28	8600
$\frac{3}{8}$	1.16	1.03	$1\frac{3}{4}$	$\frac{3}{4}$	$\frac{1}{2}$	44	12500
$\frac{1}{2}$	1.32		$1\frac{5}{8}$	$\frac{7}{8}$	$\frac{5}{8}$	70	17500
$\frac{5}{8}$	2.16		2	$1\frac{1}{8}$	$\frac{3}{4}$	130	24900
$\frac{3}{4}$	2.98		$2\frac{3}{8}$	$1\frac{1}{4}$	$\frac{7}{8}$	212	40000
$\frac{7}{8}$	3.84		$2\frac{1}{4}$	$1\frac{3}{8}$	1	300	53000
1	5.58		$3\frac{1}{4}$	$1\frac{5}{8}$	$1\frac{1}{8}$	470	61000



## Wire Rope THIMBLES

GALVANIZED FORGED STEEL

FORGED BRONZE AND STAINLESS STEEL



Fig. 466

### REGULAR

For Size Rope Inches	Galv. Per 100	Bronze Per Dozen	Stainless Steel Per Dozen	Length Overall Inches	Width Inside Inches	Galv. Wt. Per 100 in Lbs.
1/8	\$ 9.36	\$ 2.64	\$ 2.64	1 3/4	5/8	2 5/8
3/16	9.36	2.64	2.64	1 3/4	1 1/8	2 3/8
1/4	9.36	3.48	3.48	2	3/4	4 3/8
5/16	11.70	4.80	4.80	2 1/8	1 1/8	5 1/2
3/8	11.70	7.44	7.44	2 3/8	1 5/8	10 3/8
1/2	14.03	9.84	9.84	2 7/8	1 1/2	15 1/2
5/8	30.21	13.32		3 3/8	1 3/8	27 1/2
3/4	49.13	19.68		3 3/4	1 1/2	40
7/8	67.37			4 1/2	1 5/8	55
1	80.39			5 1/4	2 1/8	79

### EXTRA LARGE

1 1/8	\$238.60		6 3/4	2 1/2	125
1 1/4	238.60		7	2 3/4	138
1 1/2	355.55		7 1/2	3	250
1 3/4	533.33		10	3 1/2	512
2	545.03		10	3 1/2	600

## Sail THIMBLES

GALVANIZED MALLEABLE IRON OR BRASS



Fig. 469

*Size Inches	Galv. Each	Brass Each	Diam. Rope Inches	I. D. Hole Inches	Galv. Weight Per 100 in Lbs.
1/2		\$ .12	1/4	1/4	1/4
3/4	\$ .13	.17	1/4	1/2	1
1	.18	.28	3/8	3/8	2
1 1/4	.20	.42	3/8	3/4	3
1 1/2	.27	.56	3/8	1	4
1 3/4	.31	.69	1/2	1 1/4	8
2	.44	1.02	5/8	1 1/2	11 1/2
2 1/4	.48		5/8	1 3/8	16
2 3/4	.75		3/4	2	25

\*Size is from edge to edge across hole.

## Manila Rope THIMBLES

GALVANIZED DROP FORGED STEEL



Fig. 468

For Diam. Rope Inches	Galvanized Per 100	I. D. Hole Inches	O. D. Edge to Edge Inches	Weight Per 100 in Lbs.
3/8	\$16.38	1/2	3/8	2
1/2	19.88	3/4	1	3
5/8	21.05	3/4	1 1/4	5 1/2
3/4	25.73	3/4	1 1/2	9
7/8	28.07	1	1 3/4	17
1	39.77	1 1/8	2	25 1/2
1 1/8	49.13	1 3/8	2 1/4	34
1 1/4	60.82	1 1/2	2 1/2	38
	77.19	1 1/2	2 3/4	48

## Fast Eye SNAP SHACKLES

CAST BRONZE—BURNISHED

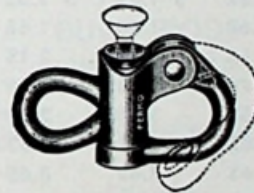

Fig. 873

No.	Each	For Diam. Rope Inches	I. D. Eye Inches	Length Inside Inches	Width Inside Inches	Wt. Ozs.
0	\$4.45	1/4	3/8	3/8	5/8	2
1	4.75	3/8-3/8	1/2	3/8	1 1/8	4
2	5.60	1/2-1/2	3/8	1 1/8	3/8	7

## HALYARD SHACKLES

CAST MANGANESE BRONZE—BURNISHED



Fig. 887

Size Inches	Each	Diam. Pin Inches	Length Inside Inches	Width Inside Inches	Weight Ounces
1/4	\$1.70	3/8	1 3/8	3/8	2 1/2



**OPEN TURNBUCKLES**

DROP FORGED STEEL—HOT GALVANIZED

HOOK AND EYE

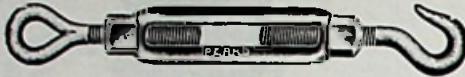

Fig. 390

EYE AND EYE



Fig. 391

HOOK AND HOOK

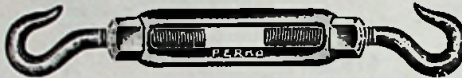

Fig. 392

JAW AND EYE

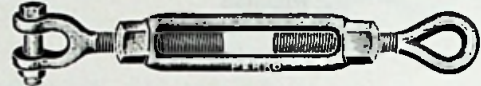

Fig. 393

JAW AND JAW

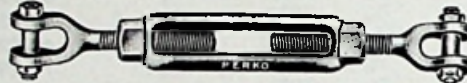

Fig. 394

Diameter and Take-up Inches	Fig. 390 Each	Fig. 391 Each	Fig. 392 Each	Fig. 393 Each	Fig. 394 Each	Overall Length Closed Inches	Opening in Hook Inches	Inside Eye Inches	Inside Jaw Inches	Approx. Weight Pounds
* 1/4 x 4	\$ 1.52	\$ 1.52	\$ 1.52	\$ 1.78	\$ 2.06	7 1/2	3/8	1 1/2 x 1 1/6	3/8 x 1 1/6	3/8
* 3/16 x 4 1/2	1.68	1.68	1.68	2.06	2.24	8 1/2	1/2	1 1/2 x 1 1/6	1/2 x 3/4	1/2
* 3/8 x 6	2.15	2.15	2.15	2.50	2.87	11	3/8	1 3/2 x 1 3/8	3/8 x 1 3/8	1
* 1/2 x 6	2.78	2.78	2.78	3.02	3.23	12	1 1/8	2 3/2 x 1 3/8	3/8 x 1	1 3/4
1/2 x 9	3.65	3.65	3.65	4.17	4.65	14 1/2		2 3/2 x 1 3/8	3/8 x 1	2 1/4
1/2 x 12	3.83	3.83	3.83	4.44	4.92	17 1/2		2 3/2 x 1 3/8	3/8 x 1	2 5/8
* 5/8 x 6	3.65	3.65	3.65	4.31	5.01	13	3/4	3/8 x 1 3/4	3/8 x 1 3/8	3
5/8 x 9	4.88	4.88	4.88	5.73	6.53	16		3/8 x 1 3/4	3/8 x 1 3/8	3 3/4
5/8 x 12	5.24	5.24	5.24	6.15	6.93	19		3/8 x 1 3/4	3/8 x 1 3/8	4
3/4 x 18		9.15		9.80	10.74	25 1/2		3/8 x 1 3/4	3/8 x 1 3/8	6 1/2
3/4 x 6	5.59	5.59	5.59	6.24	7.29	14	1 1/8	1 x 2 1/8	1 x 1 1/2	4 3/8
* 3/4 x 9	6.34	6.34	6.34	6.85	7.69	17		1 x 2 1/8	1 x 1 1/2	5 1/4
3/4 x 12	8.49	8.49	8.49	9.05	10.24	20		1 x 2 1/8	1 x 1 1/2	6 3/8
3/4 x 18		9.66		11.23	12.44	26 1/2		1 x 2 1/8	1 x 1 1/2	8
* 7/8 x 12	10.20	10.20	9.69	11.33	12.28	21 1/2	1 1/8	1 1/4 x 2 1/2	1 1/8 x 1 3/8	8 3/8
7/8 x 18		13.09		15.81	16.54	28		1 1/4 x 2 1/2	1 1/8 x 1 3/8	13 1/2
* 1 x 12	12.54	12.54	11.91	14.15	18.41	23	1 3/8	1 3/8 x 3	1 1/4 x 2	11 1/4
1 x 18		15.46		16.67	17.49	29		1 3/8 x 3	1 1/4 x 2	15 3/8
1 x 24				19.25	20.52	35		1 3/8 x 3	1 1/4 x 2	17
* 1 1/4 x 12		18.13		22.08	24.31	25		1 3/8 x 3 3/8	1 3/8 x 2	22
1 1/4 x 18		21.78		26.01	28.28	30 1/2		1 3/8 x 3 3/8	1 3/8 x 2	27 1/2
1 1/4 x 24		26.95		35.86	42.51	37		1 3/8 x 3 3/8	1 3/8 x 2	31
1 1/2 x 12				41.22	46.51	26 1/2		2 1/8 x 4 1/8	2 x 2 3/8	32 1/4
* 1 1/2 x 18				42.74	47.74	33 1/2		2 1/8 x 4 1/8	2 x 2 3/8	38 1/4
1 1/2 x 24				57.34	62.34	39 1/2		2 1/8 x 4 1/8	2 x 2 3/8	46 3/4

For one lock nut add 5% to above, for two locknuts add 10% to above.

\*Indicates standard marine length. Same will be shipped when no length is specified.

All turnbuckles have right and left hand threads.

3/4 inch diameter and larger in jaw type are supplied with pin and cotter instead of bolt and nut.



## Improved Pipe TURNBUCKLES GALVANIZED DROP FORGED STEEL WITH LOCK NUTS



Jaw and Jaw Fig. 382

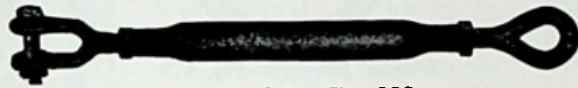

Jaw and Eye Fig. 398

Diam. Thread Inches	Fig. 382 Jaw & Jaw Each	Fig. 398 Jaw & Eye Each	Length of Pipe Inches	Weight Per 100 in Lbs.
1/4	\$ 4.00	\$ 3.75	5 1/2	47 1/2
3/16	4.28	4.09	5 3/4	62 1/2
3/8	5.36	5.05	6	102
1/2	6.45	6.13	8	178
5/8	10.57	9.80	10 1/2	369
3/4	11.12	10.31	10 1/2	500
7/8	17.71	16.80	13	775
1	21.34	19.91	14 3/8	1025
1 1/4	33.85	31.58	16	2050

## Petite TURNBUCKLES CAST BRONZE—S.A.E. THREADS



Fig. 396

No.	Burnished Each	Diam. Ends Inches	Length Extended Inches	Takeup Inches	Weight Per 100 in Lbs.
1	\$ .41	1/8	3	3/4	3
2	.48	3/32	4	1 1/8	6 1/4
3	.66	3/16	5	1 1/2	11 1/2
4	.88	1/4	5 3/4	1 7/8	15
5	1.04	5/16	6 3/4	2 1/4	24 1/2

NOTE—Nos. 1, 2 and 3 have wire eyes. Nos. 4 and 5 have cast solid eyes.

## FOOT ROPE PLATES or TRANSOM LIFTING EYES GALVANIZED FORGED STEEL

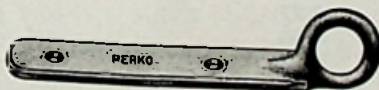

Fig. 568

Length Under Eye Inches	Galv. Each	Size Plate Inches	Inside Diam. Eye Inches	Diam. Metal In Eye Inches	Weight Pounds
3	\$ .80	3/4 x 1/4	1/2	1/4	3/16
4	1.05	7/8 x 3/16	3/4	1/4	3/8
5	1.15	1 x 1/4	3/4	3/8	1/2
6	1.55	1 x 1/4	3/4	3/8	3/4
8	1.85	1 1/4 x 3/16	1	3/8	1
10	2.75	1 1/2 x 3/16	1 1/8	3/8	1 1/2

## Bronze Rigging TURNBUCKLES DROP FORGED—WELDLESS S. A. E. THREADS



Fig. 459

These are drop forged from special high strength solid bronze bars giving unusual strength as shown in table below.

Size Inches	Plain Each	With Two Check Nuts Add	For Diam. Wire Rope Inches	Weight Each Pounds
1/4	\$ 3.05	\$ .40	1/8	3/8
3/16	5.25	.40	3/16	1/2
3/8	8.00	.45	3/8	3/4
1/2	10.80	.60	1/2	1 1/2
5/8	15.25	.65	5/8	2 3/8

1/4 inch size is cast manganese bronze.

Size Inches	Jaw Opening Inches	Diam. Pin Inches	Length Center to Center of Pins		Ultimate Strength Pounds
			Extended Inches	Closed Inches	
1/4	1/4	1/4	8 3/8	6 1/8	2300
3/16	3/16	3/16	10 3/8	7 1/4	4200
3/8	3/8	3/8	12 1/4	8 1/2	6900
1/2	1/2	1/2	14 1/2	10 1/4	11000
5/8	5/8	5/8	17	12	18000

## BUOY RODS GALVANIZED STEEL

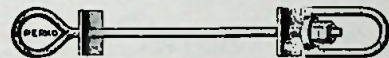

Fig. 166

No.	Each	Diameter Inches	Length Under Eye Inches	Weight Pounds
1	\$6.25	1/2	18	2 3/4
2	6.50	1/2	20	2 7/8
3	7.20	1/2	23	3 1/2
4	7.50	5/8	22	4 1/2
5	8.25	3/4	26	5 1/2
6	9.00	3/4	30	5 3/4

Swivels only, each \$1.70

## CHAIN PLATES GALVANIZED FORGED STEEL



Fig. 569

Length Under Eye Inches	Galvanized Each	Size of Plate Inches	Weight Pounds
4	\$ .85	3/4 x 3/16	1/4
6	.95	1 x 3/16	1/2
8	1.25	1 1/8 x 1/4	3/4
10	2.50	1 3/8 x 3/16	1
12	2.80	1 5/8 x 3/16	1 1/4
14	3.55	1 7/8 x 3/16	2 1/8
18	4.75	1 3/4 x 3/16	3



## Screw EYE BOLTS

GALV. DROP FORGED STEEL OR BRONZE  
LARGE EYE



Without Shoulder—Fig. 500  
With Shoulder—Fig. 501

Size Inches	Fig. 500 Galv. Each	Fig. 501 Galv. Each	Fig. 501 Burnished Bronze Each	Inside Diam. Eye Inches	Galv. Weight Per 100 in Lbs.
1/4 x 2	\$ .38	\$ .38	\$ .82	1/2	6
3/8 x 2 1/4	.49	.49	1.17	3/8	9
3/8 x 2 1/2	.54	.54	1.40	3/4	16
1/2 x 3 1/4	.80	.80	2.80	1	35
3/8 x 4	1.34	1.34		1 1/4	67
3/4 x 4 1/2	1.94	1.94		1 1/2	106

Sizes are diameter and length of shank.

## Galvanized Screw RING BOLTS

DROP FORGED STEEL

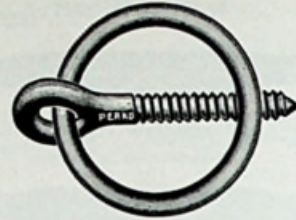

Without Shoulder—Fig. 618  
With Shoulder—Fig. 619

Size Inches	Fig. 618 Galv. Each	Fig. 619 Galv. Each	I. D. Ring Inches	Weight Per 100 in Lbs.
1/4 x 2	\$ .92	\$ .92	1 3/4	15
3/8 x 2 1/4	1.01	1.01	2	25
3/8 x 2 1/2	1.30	1.30	2	38
1/2 x 3 1/4		1.89	2 1/2	85
3/8 x 4	3.02	3.02	2 3/4	160
3/4 x 4 1/2	4.63	4.63	3	245

## Nut EYE BOLTS

GALV. DROP FORGED STEEL OR BRONZE  
LARGE EYE

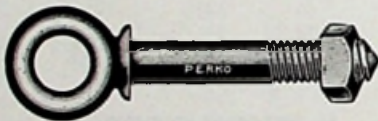

Without Shoulder—Fig. 522  
With Shoulder—Fig. 523

Size Inches	Fig. 522 Galv. Each	Fig. 523 Galv. Each	Fig. 523 Burnished Bronze Each	Inside Diam. Eye Inches	Galv. Weight Per 100 in Lbs.
1/4 x 2	\$ .40	\$ .40	\$ .94	1/2	7
1/4 x 4	.50	.50	1.28	1/2	10
3/8 x 2 1/4	.54	.54	1.28	3/8	13
3/8 x 4 1/4	.63	.63	1.78	3/8	17
3/8 x 2 1/2	.59	.59	1.67	3/4	21
3/8 x 4 1/2	.71	.71	2.44	3/4	27
3/8 x 6	.94			3/4	32
1/2 x 3 1/4	.88	.88	3.22	1	45
1/2 x 6	1.15	1.15	4.00	1	65
1/2 x 8	1.68			1	75
1/2 x 10	2.08			1	85
3/8 x 4	1.43	1.43		1 1/4	85
3/8 x 6	1.68	1.68	5.90	1 1/4	110
3/8 x 8	2.53			1 1/4	135
3/8 x 10	2.55			1 1/4	160
3/8 x 12	2.57			1 1/4	185
3/4 x 4 1/2	1.97	1.97		1 1/2	132
3/4 x 6	2.15	2.15		1 1/2	160
3/4 x 8	3.23			1 1/2	184
3/4 x 10	3.37			1 1/2	208
3/4 x 12	3.48			1 1/2	232
3/4 x 15	3.58			1 1/2	268
7/8 x 5	2.72	2.72		1 3/4	215
7/8 x 8	4.17	4.17		1 3/4	265
1 x 6	4.71	4.71		2	340
1 x 9	5.26	5.26		2	400
1 x 12	6.13			2	463
1 x 18	7.12			2	586

Sizes are diameter and length of shank.

Special lengths and threading available if ordered in manufacturing quantities.  
Bronze eye bolts are drop forged bronze, not cast.

## Nut RING BOLTS

GALV. DROP FORGED STEEL OR BRONZE

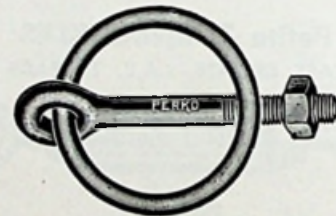

Without Shoulder—Fig. 620  
With Shoulder—Fig. 621

Size Inches	Fig. 620 Galv. Each	Fig. 621 Galv. Each	Fig. 621 Burnished Bronze Each	I. D. Ring Inches	Weight Per 100 in Lbs.
1/4 x 2	\$ 1.15	\$ 1.15	\$ 1.94	1 3/4	16
1/4 x 4	1.31	1.31		1 3/4	19
3/8 x 2 1/4	1.31	1.31	2.44	2	28
3/8 x 4 1/4	1.42	1.42		2	33
3/8 x 2 1/2	1.42	1.42	3.05	2	42
3/8 x 4 1/2	1.89	1.89		2	48
3/8 x 6	2.06			2	52
1/2 x 3 1/4	2.06	2.06		2 1/2	94
1/2 x 6	2.57	2.57		2 1/2	115
1/2 x 8	2.70			2 1/2	131
1/2 x 10	2.95			2 1/2	147
3/4 x 4	3.16	3.16		2 3/4	175
3/4 x 6	3.77	3.77		2 3/4	190
3/4 x 8	4.00			2 3/4	205
3/4 x 10	4.23			2 3/4	220
3/4 x 12	4.46			2 3/4	235
3/4 x 4 1/2	5.09	5.09		3	275
3/4 x 6	6.08	6.08		3	300
3/4 x 8	6.26			3	334
3/4 x 10	6.45			3	368
3/4 x 12	6.83			3	400
7/8 x 5	7.00	7.00		3 1/2	450
1 x 6	10.83	10.83		3 3/4	630





**TOGGLE BOLTS**  
CAST BRASS—PLAIN FINISH

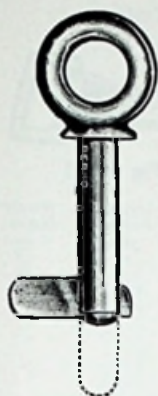

Diam. Shank Inches	Length Inches	Each
1/4	1 to 6	
3/8	1 to 6	
1/2	1 to 6	On Application
5/8	1 to 6	
3/4	1 to 6	

Made to order only, delivery about 3 weeks.

Not sold in quantities of less than 12 pieces of each diameter and length.

Length is measured from under shoulder to beginning of milled slot.

Fig. 196

**Wire Rope CLIPS**  
MALLEABLE IRON SADDLE  
STEEL U-BOLT AND NUTS



Fig. 333

Size Wire Rope Inches	Cadmium Plated Per 100	Est. Wt. Per 100 in Lbs.	Size Wire Rope Inches	Cadmium Plated Per 100	Est. Wt. Per 100 in Lbs.
1/8	\$14.41	4 1/4	1/2	\$ 33.34	37
3/16	14.41	7	5/8	44.17	59
1/4	16.84	14 1/2	3/4	63.04	84
5/16	18.76	16	7/8	90.08	128
3/8	25.94	24	1	108.12	175

**Galvanized EYE BANDS**  
STEEL—HOT GALVANIZED



Fig. 426

All sizes have bands 1 1/4" wide, all eyes are of 3/8" stock with 1/16" inside diameter.

Inside Diam. Inches	1 Eye Each	2 Eye Each	3 Eye Each	4 Eye Each
1 1/4	\$1.95	\$2.30	\$2.65	\$3.00
1 1/2	2.00	2.40	3.00	3.40
1 3/4	2.30	2.65	3.10	3.50
2	2.55	2.85	3.20	3.55
2 1/4	2.65	3.00	3.40	3.75
2 1/2	2.85	3.00	3.40	3.75
3	3.55	3.90	4.25	
3 1/2	3.90	4.65	5.00	5.40
4	4.25	5.00	5.40	
4 1/2	4.65	5.00	5.40	
5	6.40	6.80	7.20	7.60

Special sizes made to order, price on application.

**SWIVELS**  
DROP FORGED STEEL



Fig. 622

Size Inches	Galv. Each	Length Inches	Width Inside Inches	Weight Each in Lbs.
1/4	\$1.52	3 3/8	3/4	1/4
3/8	1.61	4 1/4	1 1/8	3/8
1/2	1.78	5 1/4	1 3/8	3/4
5/8	2.57	6 3/8	1 1/2	1 1/4
3/4	4.38	7 1/8	1 3/4	2 1/4
7/8	5.19	8 3/4	2	3 1/2
1	7.41	10 1/2	2 1/8	6 1/2

**SWIVEL with Jaw End**  
DROP FORGED STEEL



Fig. 623

Size Inches	Galv. Each	Length Inches	Width Between Jaws Inches	Inside of Bail Inches	Weight Each in Lbs.
1/4	\$ 1.76	4	3/8	1 1/4 x 1 1/8	3/8
3/8	1.78	4 1/8	3/8	1 1/4 x 1	1/2
1/2	1.94	5	3/8	1 3/8 x 1 1/8	3/4
5/8	2.91	6	1/2	1 3/8 x 1 1/8	1 1/8
3/4	5.89	7 3/8	1 1/4	1 3/4 x 1 1/4	2 3/4
7/8	7.97	8 1/2	1 1/4	2 x 1 3/8	4 1/4
1	11.78	9	1 3/8	2 1/8 x 1 3/8	7 3/4

**SWIVELS**  
GALVANIZED MALLEABLE IRON OR BRONZE



Fig. 624

No.	Galv. Each	Burnished Bronze Each	Size Inches	I. D. Eye Inches	Inside Width Swivel Inches	Overall Length Inches	Weight Per 100 in Lbs.
0	\$ .24	\$ .56	3/16	1/4	3/4	1 3/8	2 1/2
1	.26	.56	3/16	5/16	3/8	1 3/4	4
2	.35	.77	1/4	3/8	3/8	2 1/8	7 1/2
3	.50	.98	1/4	7/16	1/2	2 1/2	10
4	.70	1.30	3/8	1/2	3/8	3 1/4	19 1/2
5	.95	1.60	3/8	5/8	3/4	3 1/2	24 1/2
6	1.18	1.95	3/8	3/4	1	4 3/8	41

**LACING EYES**  
CAST BRASS—PLAIN

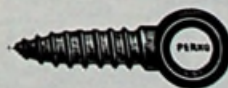

Without Shoulder  
Fig. 766

With Shoulder  
Fig. 767

Size No.	Per Dozen	I. D. of Eye Inches	Length Under Eye Inches	Wt. Per 100 in Lbs.
1	\$1.40	3/16	1	2 1/2
2	1.85	3/8	1 1/4	4 1/2
3	2.35	1/2	1 1/2	8
4	3.10	5/8	2	12



## Fast Eye BOAT SNAPS GALVANIZED MALLEABLE IRON OR BRONZE



Fig. 612

Size No.	Galv. Each	Plain Bronze Each	Polished Bronze Each	Inside Diam. Eye Inches	Extreme Length Inches	Weight Per 100 Pounds
0	\$.53	\$.65	\$1.50	3/8	2 1/8	6 1/4
1	.65	.80	1.70	3/8	2 3/4	12
2	.77	.95	2.00	3/4	3	13 1/2
3	.93	1.35	2.70	3/4	3 3/8	24
4	1.16	1.80		3/8	4 1/2	40
5	1.50	2.60		1 1/8	5	50
6	1.80			1 1/8	5 1/4	68 1/4

## BABY SNAPS

### FAST EYE



Fig. 842



Fig. 1041

Fig.	Galvanized Each	Brass Each	Size of Eye Inches	Length Inches	Weight Ounces
842		\$.20	3/8	1 1/8	1/2
1041	\$.15	.22	5/8 x 3/16	1 3/8	1/2

### SWIVEL EYE



Fig. 1042

Diam. of Eye Inches	N. P. Malleable Each	Brass Each	Length Inches	Weight Ounces
3/8	\$.22	\$.27	2 5/8	1/2

## Swivel Eye BOAT SNAPS GALVANIZED MALLEABLE IRON OR BRONZE



Fig. 613

Size No.	Galv. Each	Plain Bronze Each	Polished Bronze Each	Inside Diam. Eye Inches	Extreme Length Inches	Weight Per 100 Pounds
1	\$.93	\$1.28	\$2.30	3/8	3 1/8	12 1/2
2	1.10	1.60	2.70	1 1/8	3 3/8	16
3	1.40	2.20	3.50	3/4	4 3/8	30
4	1.70	2.45		1 1/8	4 7/8	42
5	2.10	3.55		1 3/8	5 1/4	61

## Safety MOORING HOOKS DROP FORGED STEEL—HEAT TREATED STAINLESS STEEL SPRING AND RIVET



Fig. 606

These hooks, although light in design, have exceptional strength.

### Safe Working Load

No. 1—750 Pounds. No. 2—1700 Pounds.

No.	Galvanized Each	I. D. of Eye Inches	Length Overall Inches	Throat Opening Inches	Weight Per 100 in Lbs.
1	\$1.02	3/4	4	3/4	25
1 1/2	1.33	1 1/8	4 3/4	3/4	32
2	2.50	1	5 3/8	1 1/8	100

## Swivel Eye BOAT SNAPS ZAMAK DIE CASTINGS—CHROMIUM PLATED



Fig. 1289

Size No.	Each	Inside Diam. Eye Inches	Extreme Length Inches	Weight Per 100 Pounds
1	\$.90	3/8	2 3/8	12 1/2

## Swivel Eye SNAPS MALLEABLE IRON OR BRONZE



Fig. 659

	Each	Extreme Length Inches	Inside Eye Inches	Inside Hook Inches	Weight Ounces
Iron	\$.43	3 1/2	3/4	3/8	2
Bronze	.40	4	3/4	3/8	2 1/2

Iron snap is nickel plated.  
Bronze snap is burnished.

## Swivel Eye MOORING HOOKS DROP FORGED STEEL—STAINLESS STEEL SPRING

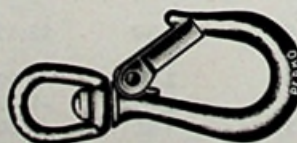

Fig. 640

An excellent hook for trailer winches.

Each	I. D. of Swivel Inches	Length Overall Inches	Throat Opening Inches	Weight Per 100 in Lbs.
\$2.22	3/4	5 1/8	1 1/8	62 1/2



## Galvanized HOOKS DROP FORGED STEEL—LARGE EYE



Fig. 656

Size Inches	Galv. Each	Hook Length Inches	I. D. Eye of Hook Inches	Throat Opening of Hook Inches	Approx. Strength Lbs.	Approx. Weight Per 100 in Lbs.
3/8	\$ .75	2 1/4	3/4	1/2	1230	12
1/2	.98	3 3/8	7/8	3/8	2620	30
5/8	1.23	5 1/4	1 1/4	3/8	3810	62
3/4	1.72	5 1/2	1 1/2	1	5710	87
7/8	2.45	6 1/2	1 3/8	1 1/8	9100	135
1	3.06	6 3/8	1 3/8	1 3/8	9700	212

## Screw HOOKS STEEL—GALVANIZED

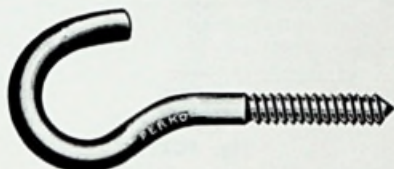

Fig. 779

Size Inches	Per 100	Length Overall Inches	Weight Per 100 Pounds
1/4	\$12.00	4	7 1/4
3/8	15.50	4	11 1/2
1/2	19.25	4	17 3/4
3/4	57.00	5 1/2	39

## "S" HOOKS GALVANIZED WROUGHT STEEL



Fig. 680

Nominal Size Inches	Per 100	Length Overall Inches	Weight Per 100 Pounds
3/16	\$ 7.25	1 1/2	2 3/4
1/4	7.75	2	7
5/16	15.50	2 1/2	14 1/2
3/8	23.20	3	18 3/4
1/2	55.50	3 3/4	50

## JIB SNAPS GALVANIZED MALLEABLE IRON



Fig. 765

Size No.	Galv. Each	Extreme Length Inches	For Diam. Stay Inches	Weight Per 100 in Lbs.
0	\$ .53	1 3/8	1/4	4 3/8
1	.65	2	3/8	10
2	.77	2 3/8	3/8	12 1/2
3	1.00	2 3/4	1/2	21
4	1.30	3	3/4	23 3/4

## Connecting or Missing LINKS DROP FORGED STEEL WITH INTERLOCKING LUGS

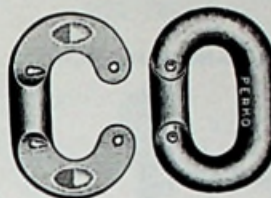

Fig. 319

Size Inches	Galv. Each	Overall Dimensions Inches	Weight Per 100 Pounds
3/8	\$ .38	1 3/8 x 3/4	3 3/4
1/4	.38	1 1/2 x 1	7 1/2
3/8	.42	1 3/4 x 1 3/8	10 3/4
1/2	.49	2 1/8 x 1 3/8	18 3/4
3/4	.65	2 3/8 x 1 1/2	38 1/2
1/2	.80	2 3/8 x 1 3/4	40
5/8	1.15	3 3/8 x 2 1/8	76
3/4	1.64	3 3/8 x 2 1/2	128
7/8	2.24	4 1/2 x 3	183
1	2.76	5 x 3 3/8	272

## SWING LINKS MALLEABLE IRON—WITH BRONZE RIVETS AND INTERLOCKING LUGS



Fig. 784

Size Inches	Galv. Per Dozen	Length Overall Inches	Diam. Eye Inches	Packed Dozens in Box	Weight Per Dozen Pounds
3/8	\$ 4.10	1 3/4	1/4	2	7 3/8
1/4	4.75	1 13/16	3/8	2	1
5/16	5.60	2 1/8	3/8	2	1 1/2
3/8	7.70	2 1/2	3/8	2	2 1/4
1/2	10.60	2 13/16	3/8	1	3 3/4
3/4	13.75	3 3/8	3/8	1	5 1/4
5/8	22.25	4 1/2	1 3/8	1/2	12

## LAP LINKS GALVANIZED WROUGHT STEEL



Fig. 785

Size Inches	Each	Inside Dimensions of Link Inches	Size Inches	Each	Inside Dimensions of Link Inches
3/16	\$ .12	1 x 1/2	3/8	\$ .33	1 1/8 x 1 3/8
1/4	.12	1 1/2 x 1/2	1/2	.59	2 x 1
3/8	.23	1 1/2 x 3/8			

## ANCHOR CHOCKS

CAST BRONZE—BURNISHED

### FOR DANFORTH ANCHORS

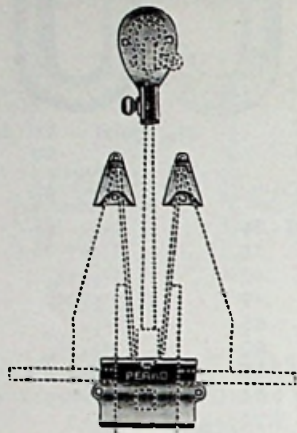

Fig. 933

Consists of four parts illustrated. Head of shank is held fast by slotted casting and thumb screw.

For all sizes up to 30 pounds inclusive.

Weight Per Set, 1 3/4 pounds

	Burnished Bronze	Burnished Chromium Plated
Complete, per set .....	\$7.50	\$8.00
Shank support only, each .....	3.25	3.50
Fluke supports only, per pair .....	2.25	2.45
Crown support only, each .....	2.25	2.45

### FOR DANFORTH ANCHORS CAST MANGANESE BRONZE

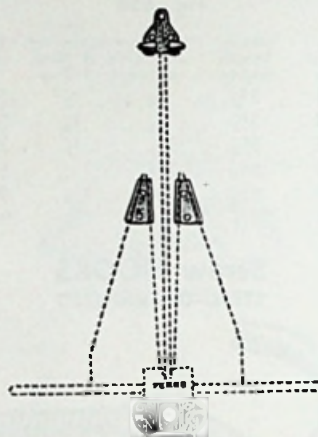

Fig. 1022

Consists of four parts illustrated. Part for shank head has integral cleat for lashing down.

	No. 0	No. 1	No. 2
Complete per set .....	\$8.75	\$9.50	\$12.50
Shank support only, each ..	3.00	3.25	4.20
Fluke supports only, per pair ..	3.50	4.10	5.50
Crown support only, each ..	3.50	4.10	5.50
For size anchor, pounds ..	4 and 5	8 to 28	40 to 90
Weight per set, pounds .....	3/4	1 1/2	2

### FOR KEDGE ANCHORS

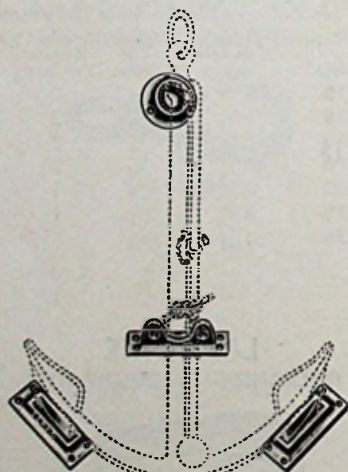

Fig. 939

Consists of four parts illustrated. The lashing piece has two eyes large enough for 3/8 inch diameter rope. For all sizes up to 75 pounds inclusive.

Weight Per Set, 2 1/2 pounds

Complete, per set .....	\$9.00
Shank support only, each .....	2.50
Lashing fitting only, each .....	2.50
Fluke supports only, per pair .....	5.00

### FOR NORTHILL ANCHORS

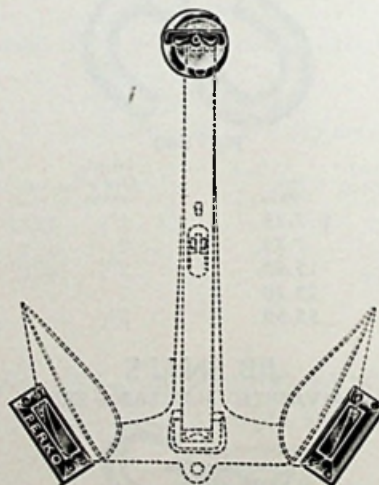

Fig. 941

Consists of three parts illustrated. Part for shank head has threaded bolt to pass through eye of shank, head is fastened down by wing nut and cross bar on bolt. For all sizes up to No. 20-R inclusive.

Weight Per Set, 2 pounds

Complete, per set .....	\$8.00
Shank support only, each .....	3.65
Fluke supports only, per pair .....	4.85



## Non-Fouling KEDGE ANCHORS GALVANIZED DROP FORGED STEEL

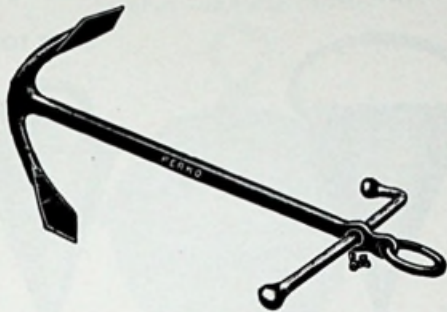

Fig. 236

The result of a great deal of experimenting and testing, the flukes are designed to bite and hold on the first pull of the cable. A weldless reinforcing under each fluke will prevent bending or breaking under maximum strain.

Weight Pounds	Galvanized Each	Length Overall Inches	Width Across Flukes Inches
5	\$ 10.35	21	13
10	14.20	26	15 1/4
15	18.45	29	18
20	23.10	32	19
25	27.00	36	20
30	29.75	36	20
35	35.00	40	22
42	37.30	40	22
50	49.35	43	24 1/2
60	55.00	44 1/2	27 1/2
75	67.00	46	29
100	91.00	50	32
125	115.50	52 1/2	32
150	131.25	59	34 1/2

## NAVY TYPE ANCHORS DROP FORGED SHANK—GALVANIZED



Fig. 45

Weight Pounds	Each	Weight Pounds	Each
5	\$ 4.65	25	\$15.75
10	7.40	30	18.40
15	9.90	40	27.50
20	12.00	50	33.00
		60	39.50

## GRAPNELS GALVANIZED DROP FORGED STEEL FIVE PRONG

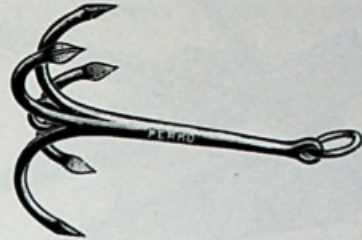

Fig. 207

Weight Pounds	Galvanized Each	Weight Pounds	Galvanized Each
4	\$ 8.50	15	\$18.25
7	10.50	20	24.50
10	13.00		

Larger sizes—prices on application.

## FISHERMAN'S ANCHORS FOR SMALL BOATS

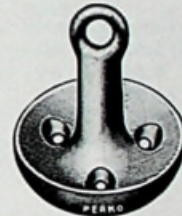

Fig. 1028

Weight Pounds	Self Colored Each	Galvanized Each	Diam. Inches	Height Inches
7	\$2.80	\$4.10	6	8
11	3.90	5.85	7	9
15	4.90	7.45	8	10

## NORTHILL UTILITY ANCHORS HEAT TREATED DUCTILON—GALVANIZED

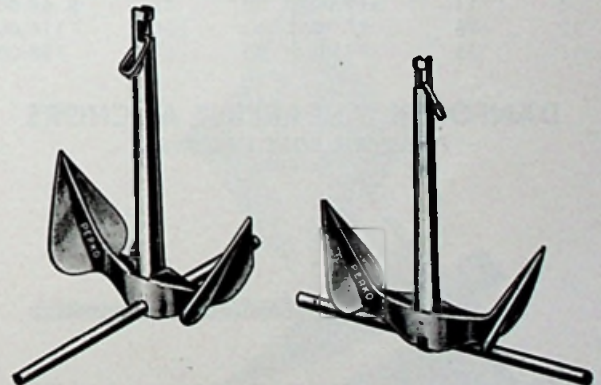
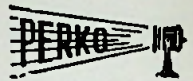

Fig. 1067

Type No.	Galv. Each	Weight Pounds	Com- parative Weight Kedge Type Pounds	Com- parative Weight Navy Type Pounds
Rowboat	\$ 5.10	3		
3R	13.30	5	30	50
6R	25.00	10	65	110
12R	46.50	24	130	225
20R	62.00	40	225	400
30R	83.50	59	350	610
50R	124.50	91	525	918

Note—Rowboat Anchor 12" long—10" wide.



## "DANFORTH" ANCHORS GALVANIZED STEEL

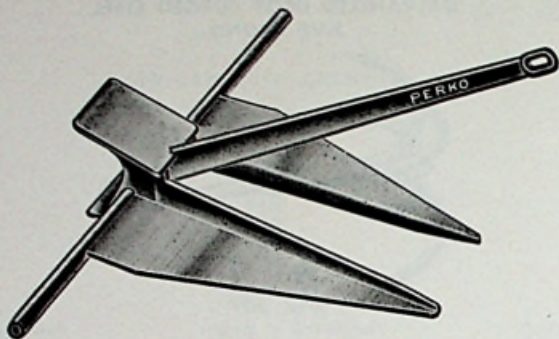

Fig. 700

### Fig. 700A "STANDARD"

FLUKES FABRICATED FROM HIGH STRENGTH  
ALLOY STEEL PLATE. SHANK IS DROP  
FORGED STEEL

Weight Pounds	Length Overall Inches	Each	Weight Pounds	Length Overall Inches	Each
2½	17¼	\$ 5.65	40	40¾	\$ 52.50
4	19	8.65	65	50	85.00
8	24	16.30	85	51	105.00
13	28½	25.80	130	57	153.00
22	35	41.00	180	60	206.00

Larger sizes, price on application.

### Fig. 700B "HIGH TENSILE"

FLUKES FABRICATED FROM ROLLED-ALLOY  
STEEL SECTIONS. SHANK IS DROP FORGED  
ALLOY STEEL.

Holding power equal to "Standard" anchors of about twice the weight.

Weight Pounds	Length Overall Inches	Each	Weight Pounds	Length Overall Inches	Each
5	21	\$19.00	28	41	\$ 68.00
12	28	37.00	60	50	118.00
18	35	49.00	90	51	158.00

## DANFORTH "SHEARPIN" ANCHORS FOR SMALL BOAT FISHERMEN

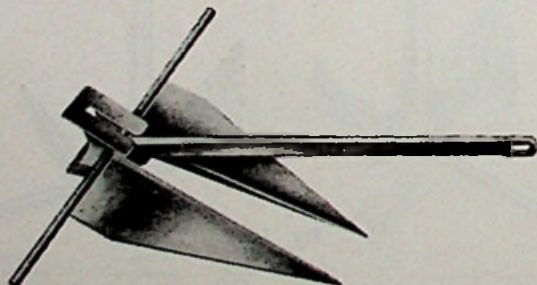

Fig. 700C

Designed to pull out backward, or crown first. Copper shearpin will allow strain of about 250 pounds at normal scope but will break at about a 30 pound pull when the boat is brought over a snagged anchor.

Weight Pounds	Each	Length Inches
4	\$ 8.65	19
8	16.30	24

## Pick Up Buoys

GALVANIZED SHEET IRON

FLAT TOP



Fig 234

CONE TOP



Fig. 235

Pick up handle is riveted to body. Eye on bottom for rope. All double seamed and soldered.

Length shown does not include eye and handle.

Fig. 234

No.	Each	Diam. Inches	Length Inches	Weight Pounds
1	\$14.50	9	14	4
2	17.00	12	18	5

Fig. 235

No.	Each	Diam. Inches	Length Inches	Weight Pounds
0	\$ 9.70	7	11	3
1	13.50	13	22	5
2	16.00	16	24	6½

## Junior MOORING BUOY FOR RUNABOUTS AND ALL SMALL BOATS GALVANIZED SHEET IRON



Fig. 318

Made of sheet iron with ½ inch forged steel galvanized rod through a galvanized pipe in body. Rod has eye on top and swivel on bottom. All the strain is on the rod.

Load capacity, half submerged, 25 lbs., dead weight. Equal to 35 feet of ¼ inch chain.

No.	Each	Diam. Body Inches	Length Body Inches	Weight Pounds
1	\$21.00	12	15	10

With rubber bumper around upper part of body add \$1.50 each.



**Round Steel MOORING BUOY**

17" DIAM.—18 GAUGE—WELDED—GALVANIZED  
STEEL ROD THROUGH CENTER—EYE ON TOP  
SWIVEL ON BOTTOM WITH 1 3/8" DIAM. RUBBER  
BUMPER—ORANGE FINISH

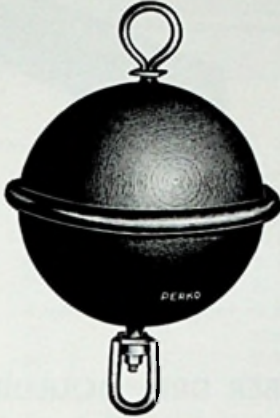

Fig. 1068

Body of buoy is grooved to firmly hold rubber bumper in place. The buoy rod passes through a length of pipe and is not attached to body of buoy. All strain is on the rod.

Load capacity, half submerged is 60 pounds, dead weight, equal to 75 feet of 1/4 inch chain or 32 feet of 3/8 inch chain.

No. 1 protected with one coat zinc chromate and one coat orange enamel.

No. 2 is hot dipped galvanized inside and outside after fabrication.

No.	Each	Diameter Rod Inches	Size Inside Swivel Inches	Weight Pounds
1	\$46.00	3/8	3 1/2 x 2	17
2	56.00	3/8	3 1/2 x 2	18 1/2

**Hold Fast MOORING BUOY  
WITH RUBBER BUMPER  
GALVANIZED SHEET IRON**



Fig. 445

A heavy gauge galvanized sheet iron body, a 3/8 inch forged rod through a galvanized pipe in the body, large eye on top, large heavy swivel on bottom, a substantial rubber bumper set in groove of body, will not mar or scratch hull of boat.

No. 1 Load Capacity, dead weight — 60 pounds

No. 2 Load Capacity, dead weight — 100 pounds

No.	Each	Diam. Body Inches	Length Body Inches	Length Overall Inches	Inside Diam. Eye Inches	Weight Pounds
1	\$32.00	13	22	33 1/2	3	13 1/2
2	42.00	17	27	38 1/2	3	17

**New "Float-Rite"  
MOORING BUOY**

GALVANIZED SHEET IRON  
GALVANIZED STEEL ROD THROUGH CENTER  
1 1/8" DIAMETER RUBBER BUMPER

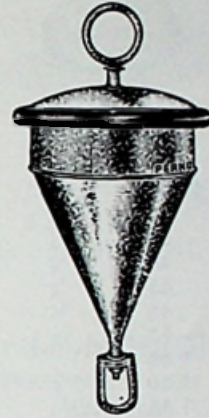

Fig. 300

Designed to float in vertical position for better visibility and allow the bumper to serve its best purpose. All strain is on the buoy rod.

An excellent buoy for small cruisers.

Load capacity, dead weight 30 lbs.

Each	Diam. Body Inches	Length Body Inches	Length Overall Inches	Inside Diam. Eye Inches	Weight Pounds
\$24.00	12	20	30	3	11

**Cone MOORING BUOY  
WITH RUBBER BUMPER  
GALVANIZED SHEET IRON**

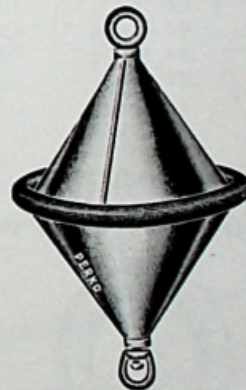

Fig. 370

Heavy galvanized iron, iron pipe running all the way through buoy, heavy galvanized 3/8 inch buoy rod through pipe allowing body to swivel, eye on top, swivel on bottom, body grooved for bumper which is of heavy 1 1/2 inch outside diameter rubber hose.

No.	Each	Body Size Inches	Load Capacity Dead Weight Pounds
1	\$48.50	16x24	35
2	60.00	20x30	60
3	73.50	24x36	90

Size does not include swivel or eye.



**Brass ACORN NUTS**

MILLED FINISH



Fig. 465

No.	Size Thread	Each	Size Hexagon Inches	Height Inches	Weight Ounces
1	8 -32	\$ .08	3/16	1/4	1/8
2	1/4-20	.10	3/16	3/8	1/4
3	3/16-18	.35	5/16	3/8	5/8
4	3/8-16	.40	5/8	3/4	3/4
5	7/16-14	.45	5/8	1	1
6	1/2-14	.45	3/4	1 1/8	1
7	1/2-13	.65	3/4	1 3/8	2
8	1/2-13	1.00	1	3/4	2 1/2
9	5/8-11	1.50	1 1/4	1 1/4	5
10	1 - 8	1.85	1 3/8	1 3/8	5

**Quarter Round RUBBER MOULDING**

BLACK

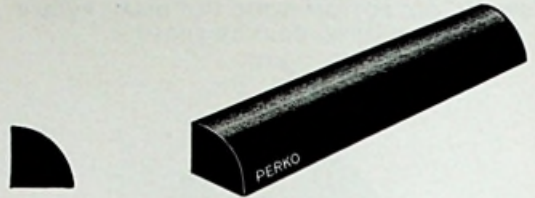

Fig. 471

Generally used as trim or moulding around cabin windows and windshields.

Size 3/8 x 3/8 inches

Per Foot — \$ .19

Supplied only in lengths of 25 feet.

**Brass WING NUTS**

U. S. S. THREAD



Fig. 453

For Diam. Bolt Inches	Threads Per Inch	Plain Brass Each	For Diam. Bolt Inches	Threads Per Inch	Plain Brass Each
3/16	24	\$ .08	1/2	13	\$ .55
1/4	20	.09	5/8	11	1.75
3/8	18	.14	3/4	10	1.75
1/2	16	.25			

**RUBBER DRIP MOULDING**

WHITE SYNTHETIC RUBBER  
NOT EFFECTED BY SUN OR WEATHER



Fig. 192

Per Foot	Height Inches	Extension Inches	Weight Per Foot Ounces
\$ .29	3/8	3/8	1 1/2

Supplied only in standard lengths of 10 feet.

**ALUMINUM HATCH MOULDING**

ANODIZED—POLISHED



Fig. 198

Drilled and countersunk for No. 6 wood screw.

Length Feet	Width Inches	Leg Inches
12	3/4	3/8

\$5.50 Per Length

Weight per length, 19 1/2 pounds.  
Special lengths to order.

**EYE NUTS**

WELDLESS DROP FORGED STEEL



Fig. 497

Threaded For Bolt Inches	Galvanized Each	Inside Dimensions Inches	Diam. of Stock Inches	Weight Per 100 in Lbs.
1/4	\$ .80	3/4 x 3/8	1/4	10
3/8	.80	3/4 x 3/8	1/4	10
1/2	.82	7/8 x 1 1/8	5/8	16
3/4	.86	1 1/4 x 1 1/2	3/4	34
1	1.05	1 1/2 x 1 3/4	1 1/2	60
1 1/4	1.97	1 3/4 x 2 1/4	3/2	97

**MOULDING ENDS**

CAST BRONZE—CHROMIUM PLATED



Fig. 111

Each	Length Overall Inches	Length Head Inches	Width Neck Inches	Weight Ounces
\$1.50	2 3/8	1 3/8	3/4	1 1/2

For finishing cut end of moulding Fig. 110.

**MOULDING COUPLINGS**

CAST BRONZE

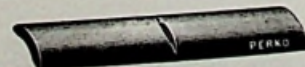
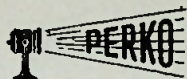

Fig. 38

For inside of Fig. 110 moulding at joint.

Each \$ .40





## Continuous HINGE WROUGHT BRASS



Fig. 211

For use on hatch covers, locker doors, windshields, etc. Holes are two inches apart, center to center.

No.	Width Open Inches	Length Inches	Polished Brass Each	Chromium Plated Each	Thickness Inches
1	1 1/4	60	\$3.90	\$5.15	.040
2	1 1/4	72	4.70	6.15	.040
3	1 1/2	60	4.25	5.70	.040
4	1 1/2	72	5.10	6.85	.040
5	2	60	5.35	7.25	.045
6	2	72	6.50	8.65	.045

1 1/4" and 1 1/2" sizes drilled for No. 5 F. H. Wood Screw. 2" size drilled for No. 6 F. H. Wood Screw.

## Flat Hatch TRIM WROUGHT BRASS OR 18-8 STAINLESS STEEL

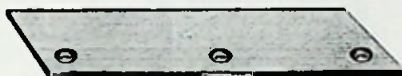

Fig. 243

For finishing around edges of hatch. Drilled and countersunk off center for No. 6 flat head screws.

No.	Width Inches	Length Inches	Brass Chromium Plated Each	Polished Stainless Steel Each	Thickness Inches
1	1 1/4	60	\$4.00		.040
2	1 1/4	72	4.50		.040
3	1 1/2	60	4.50	\$3.00	.040
4	1 1/2	72	5.30		.040

## Aluminum Fender MOULDING

ANODIZED-POLISHED-FLAT BACK

DRILLED FOR WOOD SCREWS, 6 INCH CENTERS

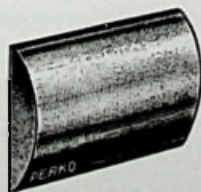

Fig. 193

Width Inches	12 Foot Lengths Each	16 Foot Lengths Each	Thickness Inches	Drilled For Screw No.	Weight Per Foot Ounces
1/2	\$2.90	\$3.85	1/8	4	1
5/8	3.20	4.25	1/4	5	1 1/4
3/4	3.50	4.65	3/32	6	1 1/2

## Rubber FENDER MOULDING HALF ROUND-WHITE

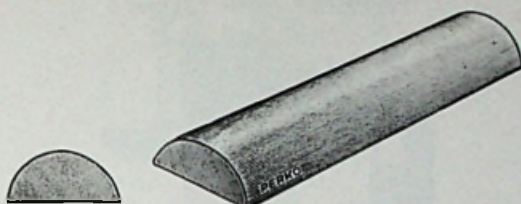

Fig. 158

Width Inches	Per Foot	Thickness Inches	Weight Per 100 Ft. Pounds
1	\$ .31	1/2	22

Supplied only in 50 foot lengths.

## Fender MOULDING

18-8 STAINLESS STEEL .045" THICKNESS  
POLISHED

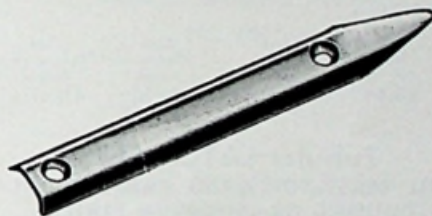

Fig. 110

Punched and countersunk 8 inch centers for No. 7 oval head wood screws.

6 foot length has both ends pointed.

12 foot length has one end pointed.

16 foot length has both ends pointed.

6 Foot Lengths Each	12 Foot Lengths Each	16 Foot Lengths Each	Width Outside Inches	Width Inside Inches	Weight Per Ft. Ounces
\$3.95	\$7.30	\$9.95	3/8	1/4	3

## Aluminum Fender MOULDING

ANODIZED-POLISHED-CURVED BACK

Drilled for No. 6 wood screws, 6 inch centers.

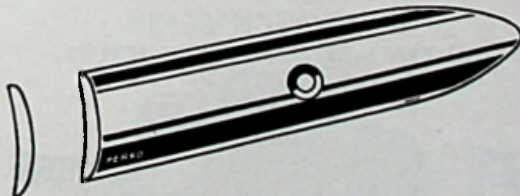

Fig. 169

12 foot lengths have one end pointed.

16 foot lengths have both ends pointed.

Width Inches	12 Foot Lengths Each	16 Foot Lengths Each	Thickness Inches	Weight Per Foot Ounces
1/2	\$4.00	\$5.90	3/32	1 1/4
5/8	4.10	6.00	1/8	1 1/2
3/4	4.75	6.50	1/8	1 3/4

Other sizes available to order.



## Mortise LOCK SETS

ALL BRASS OR STAINLESS STEEL  
REVERSIBLE—WITH SCREWS

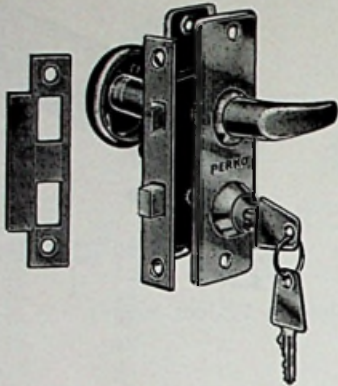

Fig. 927

Five disc tumbler type with dead bolt for inside. With round knob and lever handle, two keys.  
For door  $\frac{3}{8}$  to  $1\frac{1}{8}$  inches thick. Backset  $1\frac{1}{4}$  inches.

Brass Chromium Plated Per. Set	Stainless Steel Satin Finish Per Set	Size Case Inches	Size Facing Inches	Size Escutcheon Inches	Weight Pounds
\$9.80	\$8.65	$2\frac{1}{2} \times 1\frac{1}{2}$	$4 \times \frac{11}{16}$	$4\frac{3}{8} \times 1\frac{1}{8}$	$\frac{7}{8}$

## Tubular LATCH SETS

ALL BRASS—FOR SMALL CABIN DOORS  
POLISHED OR CHROMIUM PLATED

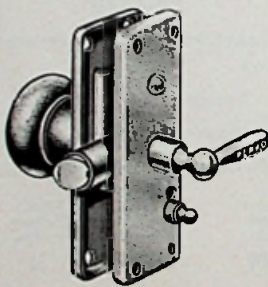

Fig. 567

Polished Brass Each	Chromium Plated Each	For Thickness Doors Inches	Size Escutcheon Inches	Size Knob Inches	Back- set Inches
\$5.75	\$7.75	$\frac{7}{8}$ to $1\frac{3}{8}$	$4\frac{3}{8} \times 1\frac{1}{8}$	$1\frac{1}{4}$	$1\frac{3}{8}$

## Rim LATCH SETS

ALL BRASS—REVERSIBLE—WITH SCREWS

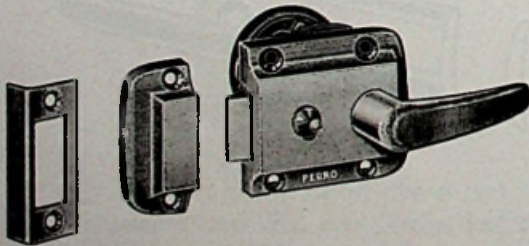

Fig. 928

With round knob and lever handle, no keys. Locked by thumb bolt inside.

Polished Brass Per Set	Chromium Plated Per Set	Size Case Inches	Diameter Escutcheon Inches	Diam. Knob Inches	Weight Pounds
\$6.00	\$7.00	$2\frac{1}{4} \times 2$	$1\frac{1}{8}$	$1\frac{1}{4}$	$\frac{3}{4}$

## Mortise LATCH SETS

ALL BRASS—WITH SCREWS—REVERSIBLE

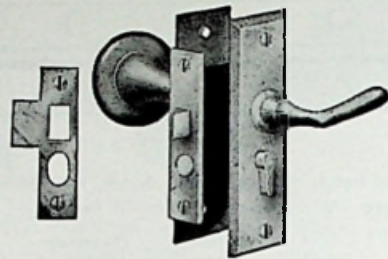

Fig. 960

Locked by dead bolt inside, no keys, with round knob and lever handle.

For door  $\frac{3}{8}$  to  $1\frac{1}{8}$  inches thick. Backset  $1\frac{3}{8}$  inches.

Polished Brass Per Set	Chromium Plated Per Set	Size Case Inches	Size Facing Inches	Size Escutcheon Inches	Weight Pounds
\$6.75	\$8.25	$2 \times 1\frac{3}{4}$	$3\frac{3}{4} \times \frac{1}{16}$	$4 \times 1\frac{3}{8}$	1

## Push-Pull LATCH SETS

DIE CASTINGS—CHROMIUM PLATED

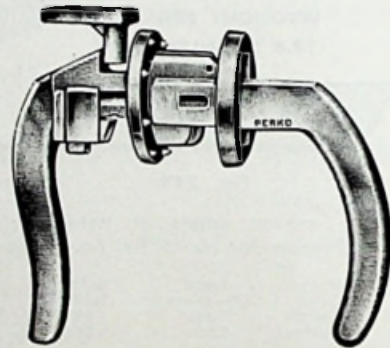

Fig. 584

Factory pre-assembled for fastest installation. Just bore a single one-inch hole. Self adjusting for various door thicknesses, minimum thickness  $\frac{3}{4}$  inch.

Positive locking—stainless steel springs.

Per Set \$4.50

## Sliding Door LATCHES

CAST BRASS

HALF MORTISE—REVERSIBLE

Operated from inside by finger lever, from outside by key.

Complete with strike, key and shield escutcheon for keyhole.

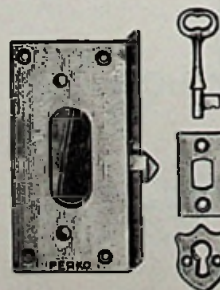

Fig. 573

No.	Size Case Inches	Width Face Inches	Weight Ounces
1	$3\frac{1}{2} \times 1\frac{3}{4}$	$\frac{3}{8}$	6
2	$5 \times 3$	$\frac{1}{16}$	20

No.	Polished Brass Per Set	Chromium Plated Per Set
1	\$ 9.25	\$11.00
2	12.25	14.75



**CUPBOARD CATCHES**  
CAST BRASS

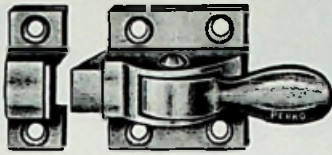

Fig. 1102

No.	Polished Brass Each	Chromium Plated Each	Without Strike Inches	Weight Per Dozen Pounds
1	\$2.40	\$3.05	1½x1½	1½
2	2.40	3.05	1½x1½	1¾

No. 2 has ⅝ inch offset.

**CUPBOARD BOLT**  
CAST BRASS

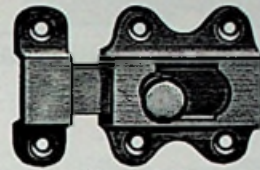

Fig. 1101

Polished Brass Each	Chromium Plated Each	Without Strike Inches	Weight Per Dozen Pounds
\$1.80	\$2.40	1¾x1⅝	1½

**CUPBOARD TURNS**  
WROUGHT BRASS

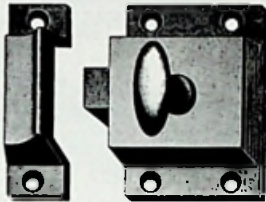

Fig. 1105

Furnished complete with screws.

Polished Brass Each	Chromium Plated Each	Without Strike Inches	Weight Per Dozen Pounds
\$2.00	\$2.60	2¼x1½	3

**Flush RING CATCHES**  
CAST BRASS

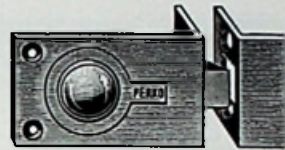

Fig. 1051

Polished Brass Each	Chromium Plated Each	Size Inches	Weight Ounces
\$1.75	\$2.25	1⅝x1¼	1½

**CUPBOARD TURNS**  
CAST BRASS

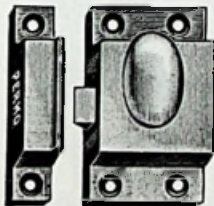

Fig. 949

No.	Polished Brass Each	Chromium Plated Each	Without Strike Inches	Weight Per Dozen Pounds
1	\$2.55	\$3.05	1¾x1⅞	3½
2	3.05	3.55	2⅞x1⅞	5½

**Flush RING PULLS**  
CAST BRASS

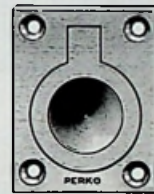

Fig. 841

No.	Polished Brass Each	Chromium Plated Each	Size Plate Inches	Weight Ounces
1	\$1.00	\$1.25	1¼x1½	1
2	1.25	1.60	1½x1½	1½

**Flush RING PULLS**  
CAST BRASS  
WITH ROUND STOCK IN RING

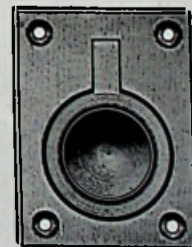

Fig. 1103

No.	Polished Brass Each	Chromium Plated Each	Size Plate Inches	Weight Ounces
1	\$1.25	\$1.80	1¼x1½	1¼
2	1.45	2.00	1⅞x2½	2¾
3	2.45	3.05	2 x 2¾	3¼

**FLUSH PULLS**  
CAST BRASS

FOR DRAWERS, SASH OR SLIDING DOORS

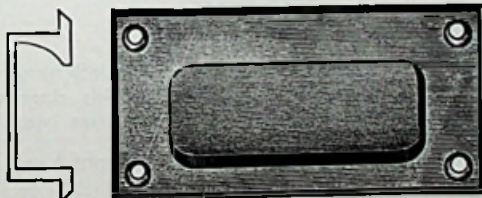

Fig. 1110

Inside recessed for finger grip as illustrated.

Polished Brass Each	Chromium Plated Each	Dimensions Inches	Mortise Depth Inches	Weight Ounces
\$2.15	\$2.60	3x1¼	⅞	3

**Mortise LOCK SETS**  
ALL BRASS OR STAINLESS STEEL  
REVERSIBLE—WITH SCREWS

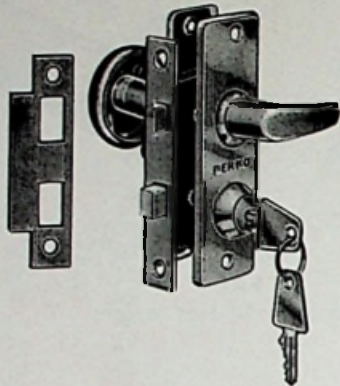

Fig. 927

Five disc tumbler type with dead bolt for inside. With round knob and lever handle, two keys.  
For door  $\frac{3}{8}$  to  $1\frac{1}{8}$  inches thick. Backset  $1\frac{1}{8}$  inches.

Brass Chromium Plated Per. Set	Stainless Steel Satin Finish Per Set	Size Case Inches	Size Facing Inches	Size Escutcheon Inches	Weight Pounds
\$9.80	\$8.65	$2\frac{1}{4} \times 1\frac{1}{2}$	$4 \times \frac{1}{4}$	$4\frac{3}{4} \times 1\frac{1}{4}$	$\frac{7}{8}$

**Tubular LATCH SETS**  
ALL BRASS—FOR SMALL CABIN DOORS  
POLISHED OR CHROMIUM PLATED

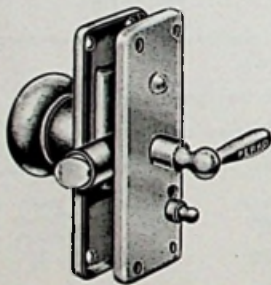

Fig. 567

Polished Brass Each	Chromium Plated Each	For Thickness Doors Inches	Size Escutcheon Inches	Size Knob Inches	Back- set Inches
\$5.75	\$7.75	$\frac{3}{8}$ to $1\frac{3}{8}$	$4\frac{3}{4} \times 1\frac{3}{8}$	$1\frac{3}{4}$	$1\frac{3}{8}$

**Rim LATCH SETS**  
ALL BRASS—REVERSIBLE—WITH SCREWS

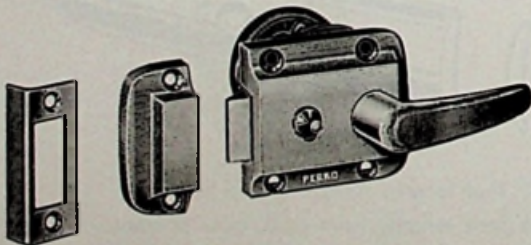

Fig. 928

With round knob and lever handle, no keys. Locked by thumb bolt inside.

Polished Brass Per Set	Chromium Plated Per Set	Size Case Inches	Diameter Escutcheon Inches	Diam. Knob Inches	Weight Pounds
\$6.00	\$7.00	$2\frac{1}{4} \times 2$	$1\frac{1}{8}$	$1\frac{3}{4}$	$\frac{3}{4}$

**Mortise LATCH SETS**  
ALL BRASS—WITH SCREWS—REVERSIBLE

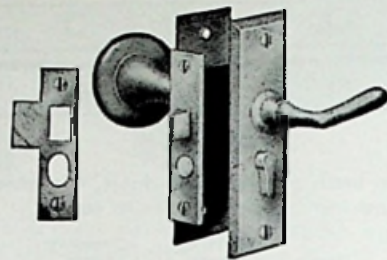

Fig. 960

Locked by dead bolt inside, no keys, with round knob and lever handle.

For door  $\frac{3}{8}$  to  $1\frac{1}{8}$  inches thick. Backset  $1\frac{3}{8}$  inches.

Polished Brass Per Set	Chromium Plated Per Set	Size Case Inches	Size Facing Inches	Size Escutcheon Inches	Weight Pounds
\$6.75	\$8.25	$2 \times 1\frac{3}{4}$	$3\frac{1}{4} \times 1\frac{1}{8}$	$4 \times 1\frac{3}{8}$	1

**Push-Pull LATCH SETS**  
DIE CASTINGS—CHROMIUM PLATED

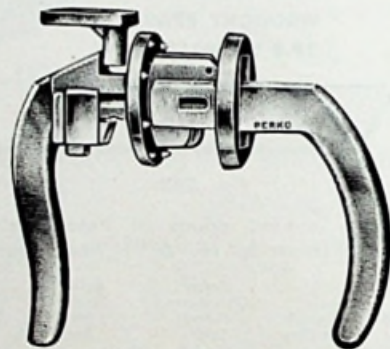

Fig. 584

Factory pre-assembled for fastest installation. Just bore a single one-inch hole. Self adjusting for various door thicknesses, minimum thickness  $\frac{3}{4}$  inch.

Positive locking—stainless steel springs.

Per Set \$4.50

**Sliding Door LATCHES**  
CAST BRASS

HALF MORTISE—REVERSIBLE

Operated from inside by finger lever, from outside by key.

Complete with strike, key and shield escutcheon for keyhole.

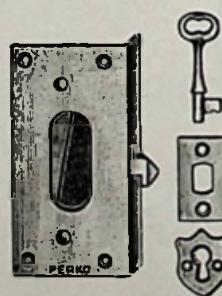

Fig. 573

No.	Size Case Inches	Width Face Inches	Weight Ounces
1	$3\frac{1}{2} \times 1\frac{1}{4}$	$\frac{5}{8}$	6
2	$5 \times 3$	$\frac{1}{16}$	20

No.	Polished Brass Per Set	Chromium Plated Per Set
1	\$ 9.25	\$11.00
2	12.25	14.75



**CUPBOARD CATCHES**  
CAST BRASS

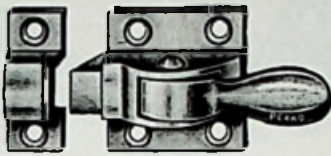

Fig. 1102

No.	Polished Brass Each	Chromium Plated Each	Without Strike Inches	Weight Per Dozen Pounds
1	\$2.40	\$3.05	1 1/2 x 1 1/2	1 1/2
2	2.40	3.05	1 1/2 x 1 1/2	1 3/4

No. 2 has 3/8 inch offset.

**CUPBOARD BOLT**  
CAST BRASS

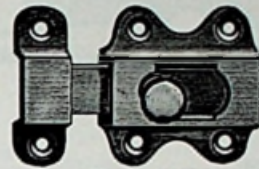

Fig. 1101

Polished Brass Each	Chromium Plated Each	Without Strike Inches	Weight Per Dozen Pounds
\$1.80	\$2.40	1 3/4 x 1 3/8	1 1/2

**CUPBOARD TURNS**  
WROUGHT BRASS

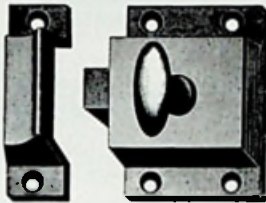

Fig. 1105

Furnished complete with screws.

Polished Brass Each	Chromium Plated Each	Without Strike Inches	Weight Per Dozen Pounds
\$2.00	\$2.60	2 1/4 x 1 1/2	3

**Flush RING CATCHES**  
CAST BRASS

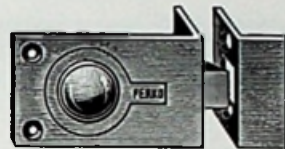

Fig. 1051

Polished Brass Each	Chromium Plated Each	Size Inches	Weight Ounces
\$1.75	\$2.25	1 5/8 x 1 1/4	1 1/2

**Flush RING PULLS**  
CAST BRASS

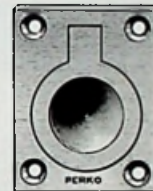

Fig. 841

No.	Polished Brass Each	Chromium Plated Each	Size Plate Inches	Weight Ounces
1	\$1.00	\$1.25	1 1/4 x 1 1/2	1
2	1.25	1.60	1 1/2 x 1 3/8	1 1/2

**CUPBOARD TURNS**  
CAST BRASS

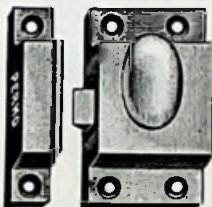

Fig. 949

No.	Polished Brass Each	Chromium Plated Each	Without Strike Inches	Weight Per Dozen Pounds
1	\$2.55	\$3.05	1 3/4 x 1 1/8	3 1/2
2	3.05	3.55	2 3/8 x 1 3/8	5 1/2

**Flush RING PULLS**  
CAST BRASS  
WITH ROUND STOCK IN RING

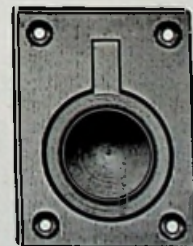

Fig. 1103

No.	Polished Brass Each	Chromium Plated Each	Size Plate Inches	Weight Ounces
1	\$1.25	\$1.80	1 1/4 x 1 1/2	1 1/4
2	1.45	2.00	1 3/8 x 2 1/2	2 3/4
3	2.45	3.05	2 x 2 3/4	3 1/4

**FLUSH PULLS**

CAST BRASS  
FOR DRAWERS, SASH OR SLIDING DOORS

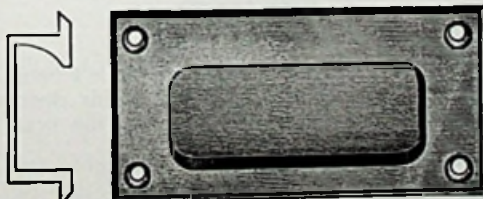

Fig. 1110

Inside recessed for finger grip as illustrated.

Polished Brass Each	Chromium Plated Each	Dimensions Inches	Mortise Depth Inches	Weight Ounces
\$2.15	\$2.60	3 x 1 1/4	3/8	3

**BARREL BOLTS**  
CAST BRASS

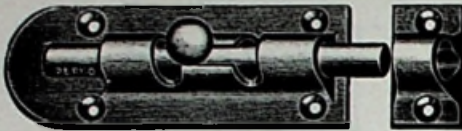

Fig. 947

No.	Polished Brass Each	Chromium Plated Each	Length Rod Inches	Size Base Without Strike Inches	Weight Per Dozen Pounds
0	\$1.65	\$2.15	2 1/4	2 x 1	1 1/2
1	1.75	2.25	2 1/2	2 3/8 x 1 1/4	1 3/4
2	2.10	2.75	3	3 x 1 1/4	2
3	2.75	3.20	4	3 1/2 x 1 1/4	3

**Cabin DOOR HOOKS**  
CAST BRASS



Fig. 956

Lgth. Hook In.	Polished Brass Each	Chromium Plated Each	Wt. Ozs.	Lgth. Hook In.	Polished Brass Each	Chromium Plated Each	Wt. Ozs.
1 1/2	\$1.05	\$1.40	1	3 1/2	\$1.45	\$1.85	2 1/2
2	1.10	1.45	1 1/2	4	1.55	2.10	3
2 1/2	1.15	1.65	1 3/4	5	1.75	2.25	3 1/2
3	1.25	1.75	2	6	1.90	2.45	4

**FLUSH BOLTS**  
CAST BRASS

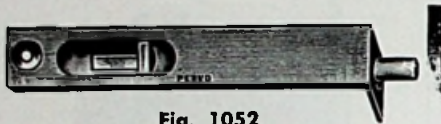

Fig. 1052

No.	Polished Brass Each	Chromium Plated Each	Size Inches	Weight Ounces
1	\$2.15	\$2.70	5/8 x 2 1/2	1 1/2
2	2.40	2.95	3/8 x 3	2

**SHIP BOLTS**  
CAST BRASS



Fig. 1053

No.	Polished Brass Each	Chromium Plated Each	Size Without Strike Inches
1	\$1.45	\$1.85	2 3/8 x 1 1/8
2	2.00	2.55	3 3/8 x 1 3/8

**SQUARE NECK BOLTS**  
CAST BRASS

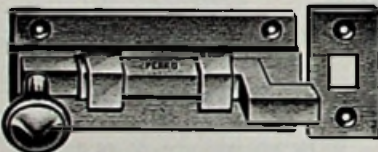

Fig. 1054

No.	Polished Brass Each	Chromium Plated Each	Size Inches
1	\$2.00	\$2.55	3 x 1 1/4
2	2.40	3.05	4 x 1 3/8

**Anti-Rattle DOOR FASTENER**  
CAST BRASS

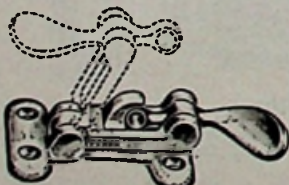

Fig. 1108

Has 1/4 inch hole in lever for padlock.

Polished Brass Each	Chromium Plated Each	Size Base Inches	Weight Ounces
\$3.65	\$4.80	3x2	6

**Cabin DOOR HOOKS**  
DOUBLE JOINTED  
CAST BRASS



Fig. 957

Length Overall Inches	Polished Brass Each	Chromium Plated Each	Length Overall Inches	Polished Brass Each	Chromium Plated Each
2	\$2.10	\$2.55	4	\$2.55	\$3.20
2 1/2	2.10	2.55	5	3.55	4.30
3	2.20	2.65	6	3.70	4.55

**Cabinet LATCHES**  
CAST BRASS

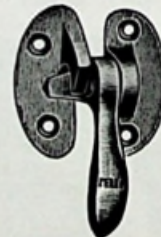

Fig. 1064

With flush striking plate and brass pin, spring closing. Made either right or left hand.

Polished Brass Each	Chromium Plated Each	Length Overall Inches	Length Lever Inches
\$1.60	\$1.85	2 1/2	2

Specify right or left hand.

**Refrigerator FASTENERS**  
CAST BRASS

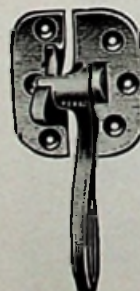

Fig. 1063

Made either right or left hand with flush striking plate. Holds door without strain on the rivet. Has brass pin.

Illustration shows right hand.

No.	Chromium Plated Each	Length Overall Inches	Size Lever Inches
1	\$4.25	5	4

Specify right or left hand.



**Cupboard DOOR HOLDERS**  
BRASS PLATED

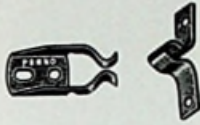

Fig. 1178

A useful little friction catch for use on cabinets, closets, cupboards and all small doors, size overall — 1½x1¼ inches.

Per Dozen .....\$1.30

**Friction CATCHES**  
ALL BRASS—ADJUSTABLE TENSION

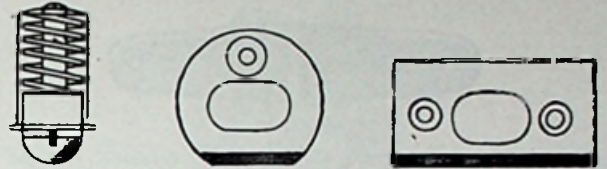

Fig. 178

Above cuts are full size. Supplied complete with either round or oblong strike. Please specify.

Per Dozen \$2.85

**DOOR HOLDERS**  
SIDE PATTERN  
CAST BRONZE

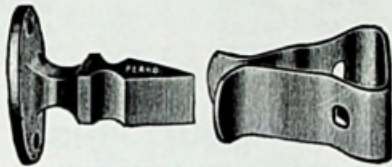

Fig. 1065

Polished Bronze Per Set	Chromium Plated Per Set	Base of Holder Inches	Base of Clip Inches	Projection Inches
\$1.90	\$2.45	1⅝x¾	2⅞x¾	2

**Elbow CATCHES**  
CAST BRASS

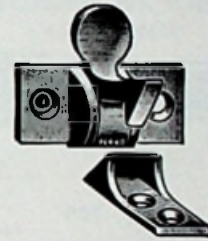

Fig. 1056

Plain Brass Each	Polished Brass Each	Chromium Plated Each	Size Base Inches	Weight Ounces
\$.60	\$1.05	\$1.30	1⅝x¾	1

**DOOR STOP and HOLDER**  
CAST BRASS



Fig. 574

Polished Brass Each	Chromium Plated Each	Diam. Base Inches	Projection Inches	Weight Ounces
\$4.45	\$5.30	1⅝	3¼	7¼

**DRAWER KNOBS**  
BRASS—FOR DRAWERS UP TO 1¼" THICK



Fig. 925

Polished Brass Per Dozen	Chromium Plated Per Dozen	Diameter Inches	Weight Per Dozen Ounces
\$7.60	\$10.60	1	12

**DOOR BUTTONS**  
CAST BRASS BUTTON—WROUGHT BRASS PLATE

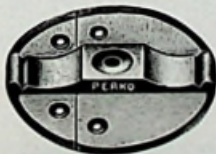

Fig. 948

No.	Diam. Inches	Polished Brass Complete Per Dozen		Chromium Plated Complete Per Dozen	
		Without Plate Per Dz.	With Plate Per Dz.	Without Plate Per Dz.	With Plate Per Dz.
1	1½	\$6.25	\$2.50	\$11.75	\$4.25
2	1¼	7.65	3.00	12.75	4.85
3	2	9.00	3.60	13.25	5.50

**DRAWER PULLS**  
CAST BRASS



Fig. 958

No.	Polished Brass Each	Chromium Plated Each	Width Overall Inches	Width Inside Inches	Weight Ounces
1	\$.60	\$.90	3⅝	2½	2
2	.90	1.15	4	2⅞	3



## STRAP HINGES

GALVANIZED MALLEABLE IRON OR BRASS  
BRASS PINS



Fig. 120

Length Open Inches	Galvanized Per Pair	Plain Brass Per Pair	Polished Brass Per Pair	Chromium Plated Per Pair	Weight Per Pair Pounds
4	\$1.40	\$2.40	\$ 3.70	\$ 4.75	$\frac{3}{16}$
6	2.20	3.05	5.25	6.50	$\frac{5}{16}$
8	3.15	4.25	7.00	8.75	$\frac{3}{8}$
10		6.00	9.00	11.00	$1\frac{1}{16}$
12		8.65	11.75	14.75	$1\frac{3}{8}$

## PORT HINGES

GALVANIZED MALLEABLE IRON OR BRASS  
BRASS PINS

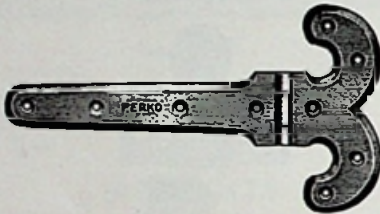

Fig. 109

Length Open Inches	Galvanized Per Pair	Plain Brass Per Pair	Polished Brass Per Pair	Chromium Plated Per Pair	Weight Per Pair Pounds
4	\$1.60	\$ 3.50	\$ 5.60	\$ 6.70	$\frac{1}{2}$
6	2.50	4.65	7.60	9.00	$\frac{7}{8}$
8	4.25	7.50	10.95	12.75	$1\frac{1}{2}$
10	6.75	10.20	15.00	17.25	2
12	8.95	13.50	18.60	22.00	$2\frac{3}{4}$

## CUDDY DOOR HINGES

WROUGHT BRASS—THICKNESS .060 INCHES

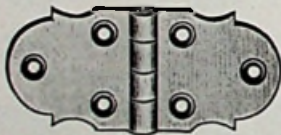

Fig. 924

Polished Brass Per Doz. Pairs	Chromium Plated Per Doz. Pairs	Length Open Inches	Extreme Width Inches
\$18.20	\$23.75	2 $\frac{1}{2}$	1 $\frac{1}{2}$

## CUDDY DOOR HINGES

CAST BRASS

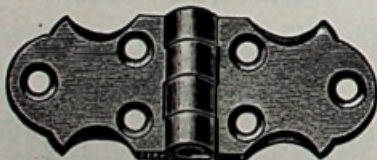

Fig. 951

Length Open Inches	Plain Brass Per Pair	Polished Brass Per Pair	Chromium Plated Per Pair
3	\$1.65	\$2.30	\$3.05
4	2.00	2.85	3.55
5	2.60	3.60	4.80

## Fast Pin BUTT HINGES

CAST BRASS—BRASS PINS

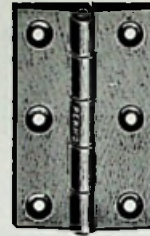

Fig. 952

Size Open Inches	Emery Finish Per Dz. Pairs	Polished Chromium Plated Per Dz. Pairs	Size Open Inches	Emery Finish Per Dz. Pairs	Polished Chromium Plated Per Dz. Pairs
1 $\frac{1}{2}$ x 1 $\frac{1}{4}$	\$15.60	\$31.35	2 $\frac{1}{2}$ x 1 $\frac{3}{4}$	\$24.80	\$53.65
1 $\frac{1}{2}$ x 1 $\frac{1}{2}$	17.10	35.25	2 $\frac{1}{2}$ x 2	30.25	45.00
2 x 1 $\frac{1}{4}$	17.70	38.15	2 $\frac{1}{2}$ x 2 $\frac{1}{2}$	38.35	56.65
2 x 1 $\frac{1}{2}$	20.45	40.30	3 x 2	38.35	58.60
2 x 1 $\frac{3}{4}$	22.60	45.00	3 x 2 $\frac{1}{2}$	43.70	73.30
2 x 2	24.00	45.00	3 x 3	46.85	85.50

## Loose Pin BUTT HINGES

BRASS WITH BRASS PINS

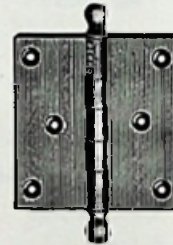

Fig. 953

Size Open Inches	Pol. Brass Per Pair	Chromium Plated Per Pair	Size Open Inches	Pol. Brass Per Pair	Chromium Plated Per Pair
1 $\frac{1}{2}$ x 1 $\frac{1}{2}$	\$3.00	\$3.75	2 $\frac{1}{2}$ x 2 $\frac{1}{2}$	\$4.95	\$6.45
2 x 1 $\frac{1}{2}$	3.30	4.40	3 x 2	5.20	6.80
2 x 2	3.65	4.85	3 x 2 $\frac{1}{2}$	5.60	7.40
2 $\frac{1}{2}$ x 2	4.20	5.50	3 x 3	5.85	7.70

## Butterfly HINGES

WROUGHT BRASS—PLAIN

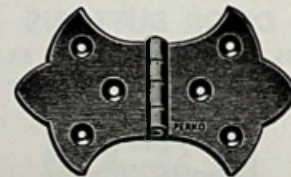

Fig. 1058

No.	Plain Brass Per Pair	Polished Brass Per Pair	Chromium Plated Per Pair
1	\$.30	\$.40	\$.55
2	.50	.60	1.00

No.	Length Open Inches	Width at Pin Inches	Weight Per Pair Ounces	Thickness Inches
1	2 $\frac{1}{4}$	$\frac{3}{4}$	$\frac{1}{2}$	.040
2	3 $\frac{1}{4}$	1 $\frac{1}{16}$	1 $\frac{1}{2}$	.045





**CABINET HINGES**  
BRASS—POLISHED OR CHROMIUM PLATED  
FLUSH OR OFFSET

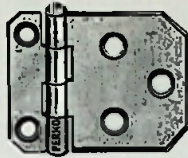

Fig. 772

Packed one dozen pairs per box, complete with screws.  
Offset is 3/8 inch.

	Polished Brass Per Doz. Pairs	Chromium Plated Per Doz. Pairs	Size Open Inches	Gauge	Weight Per Pair Ounces
Offset	\$21.60	\$26.50	2x1 1/2	14	2
Flush	21.60	26.50	2x1 1/2	14	2

**HATCH HINGES**  
CAST BRONZE

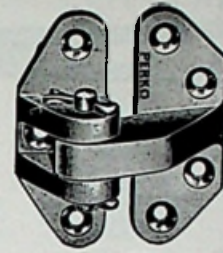

Fig. 773

For use with flush hatch cover.

Polished Bronze Per Pair	Chromium Plated Per Pair	Length Inches	Width Overall Inches	Weight Per Pair Pounds
\$8.75	\$11.00	3 3/8	2 5/8	1 3/4

Illustration shows one half pair.

**CABINET HINGES**  
BRASS—POLISHED OR CHROMIUM PLATED  
FLUSH OR OFFSET

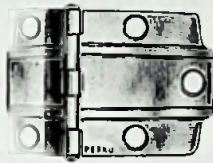

Fig. 768

	Polished Brass Per Dozen Pairs	Chromium Plated Per Dozen Pairs	Size Open Inches	Gauge	Weight Per Pair Ounces
Offset	\$16.00	\$16.80	2 3/8 x 1 1/2	14	2
Flush	16.00	16.80	2 3/8 x 1 1/2	14	2

**LADDER HINGES**  
CAST BRONZE



Fig. 556

Polished Bronze Per Pair	Chromium Plated Per Pair	Length Open Inches	Width Inches	Weight Per Pair Ounces
\$7.60	\$8.65	5 3/4	3/4	9

**Security HINGED HASPS**  
WROUGHT BRASS—14 B. & S. GAUGE



Fig. 979

A lightweight but strong hasp. Ideal for lockers, cupboards, chests, etc.

Polished Brass Each	Chromium Plated Each	Length Closed Inches	Width Inches	Weight Ounces
\$1.05	\$1.35	2 3/8	1	1 1/4

**SPRING HINGES**  
WROUGHT BRASS—PLAIN

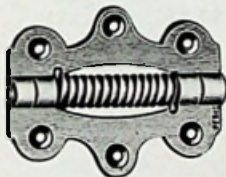

Fig. 1059

No.	Per Pair	Length Inches	Width Open Inches	Weight Per Pair Ounces
1	\$1.15	2 3/8	1 3/8	3
2	1.85	3	2 3/8	5

**FLAP HINGES**  
WROUGHT BRASS—THICKNESS .050 INCHES



Fig. 929

Polished Brass Per Pair	Chromium Plated Per Pair	Length Open Inches	Extreme Width Inches	Weight Per Pair Ounces
\$ .82	\$1.10	2	3/8	1 1/4

**Security HINGED HASPS**  
CAST BRONZE

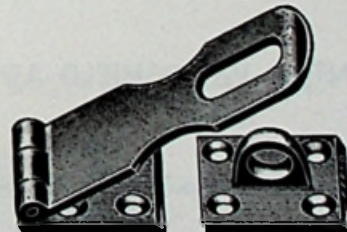

Fig. 955

Length Closed Inches	Polished Bronze Each	Chromium Plated Each	Width Inches	Weight Ounces
2	\$1.55	\$2.05	1	1 1/2
3	1.60	2.10	1	2 1/2
3 3/4	1.95	2.50	1 1/8	4 1/2



**HATCH SUPPORT HINGES**  
CAST BRASS—CHROMIUM PLATED



Fig. 758

Cut shows left hand hinge.

Length Open Inches	Per Pair	Drilled for Screw No.	Weight Ounces Per Pair	Packed Per Box Pairs
8	\$ 5.60	5	4	12
10	6.25	6	6	12
12	7.10	6	8	12

**HATCH ADJUSTERS**  
CAST BRONZE

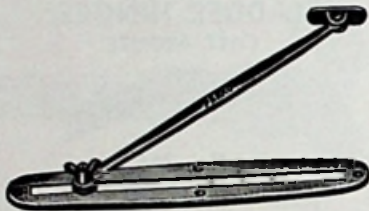

Fig. 797

Polished Bronze Each	Chromium Plated Each	Length Arm Inches	Length Adjustment Inches	Length Plate Inches	Weight Ounces
\$6.20	\$7.55	10	9½	10¾	13

**CASEMENT ADJUSTERS**  
ALL BRASS—HEAVY PATTERN

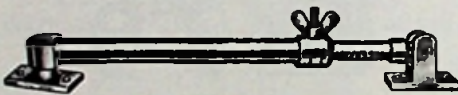

Fig. 1179

A non-slip adjuster with powerful grip to stay put in position desired.

Illustration shows swivel base on left side and swinging base on right.

Chromium Plated Each	Length Closed Inches	Length Open Inches	Diam. Outside Tube Inches	Weight Ounces
\$9.25	12	20	½	11

**CASEMENT or WINDSHIELD ADJUSTERS**  
CAST BRASS

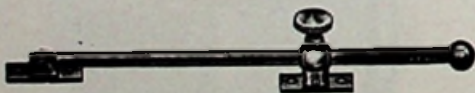

Fig. 1116

No.	Polished Brass Each	Chromium Plated Each	Length Inches	Diam. Rod Inches	Weight Ounces
1	\$6.50	\$7.00	8	¾	11
2	6.55	7.25	10	¾	12
3	6.60	7.30	12	¾	13

**Flush Hatch LIFTING HANDLE**

CAST BRASS—SAFETY TYPE



Fig. 774

No recess to catch heels, chair or table legs, etc.

Polished Bronze Each	Chromium Plated Each	Size Plate Inches	Handle Inside Inches	Weight Ounces
\$3.35	\$3.75	3x2¼	1¾x1	6

**Flush DROP HANDLES**

CAST BRASS

RECESSED TYPE—FOR CHEST, HATCHES, ETC.



Fig. 1111

No.	Polished Brass Each	Chromium Plated Each	Size Plate Inches	Width Inside Handle Inches	Weight Ounces
1	\$2.85	\$3.55	3 x2¼	1¾	4
2	3.20	3.95	3½x2½	2¾	6½
3	6.00	7.10	4¾x4	2¾	19

**Flush Hatch LIFTING RING**

CAST BRASS—SAFETY TYPE



Fig. 575

No recess to catch heels, chair or table legs, etc.

No.	Polished Brass Each	Chromium Plated Each	Size Plate Inches	Inside Ring Inches	Weight Ounces
1	\$1.55	\$2.05	2½x1½	1¾	3¾
2	2.45	3.10	2¾x2¼	1¾	6



**WARDROBE HOOK**  
CAST BRASS—WITH SCREWS



Fig. 635

Chromium Plated Each	Projection Inches	Width Inches	Weight Ounces
\$ .65	2	1 1/4	1

**WARDROBE HOOK**  
CAST BRASS—WITH SCREWS



Fig. 1106

Chromium Plated Each	Projection Inches	Width Base Inches	Weight Ounces
.70	7/8	3 3/4	1 1/4

**COAT AND HAT HOOKS**  
CAST BRASS—WITH SCREWS



Fig. 959

Polished Brass Each	Chromium Plated Each	Projection Inches	Width Base Inches	Weight Ounces
\$ .45	\$ .65	2 1/8	1 1/8	1 1/4

**UTILITY HOOK**  
CAST BRASS—WITH SCREWS



Fig. 610

Polished Brass Per Dozen	Chromium Plated Per Dozen	Projection Inches	Width Base Inches	Weight Ounces
\$4.80	\$6.00	1 1/8	1 3/8	1

**TABLE LEG FASTENERS**  
CAST BRASS

For fastening table leg to deck.

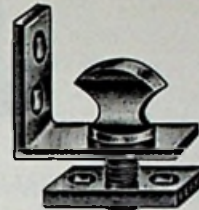
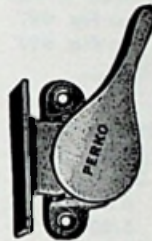

Fig. 719

Plain Brass Each	Polished Brass Each	Chromium Plated Each	Length Angle Inches	Width Angle Inches	Weight Ounces
\$2.25	\$2.75	\$3.75	1 3/4	3/8	4

**SASH FASTENERS**  
LEFT OR RIGHT HAND  
CAST BRONZE



Please specify left or right hand.

Fig. 777

Polished Bronze Each	Chromium Plated Each	Size Mounting Plate Inches	Weight Ounces
\$1.45	\$1.90	1 3/4 x 1	1 1/2

**SASH or SKYLIGHT FASTENERS**  
CAST BRONZE



Fig. 770

Size Inches	Burnished Finish Each	Polished Bronze Each	Chromium Plated Each
3/8 x 4	\$4.00	\$5.25	\$6.25

**SASH ANTI RATTLES**  
CAST BRONZE

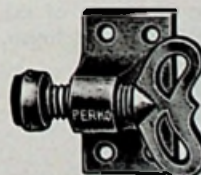

Fig. 839

Polished Bronze Each	Chromium Plated Each
\$2.50	\$2.90

Furnished with leather tip to prevent defacing of wood-work. Size of base 1 3/8" x 1".



## CURTAIN FASTENERS ALL BRASS—WITH BRASS SCREW

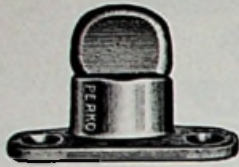

**FLANGED STUD**  
Single Fig. 994  
Double Fig. 995



**SCREW STUD**  
Single Fig. 991  
Double Fig. 998



**Eyelet**  
Fig. 996



**Washer**  
Fig. 997

Stud Figs. 991, 998 has brass  $\frac{3}{8}$ " No. 7 wood screw.  
Single Studs used with one Fig. 996 and one Fig. 997.  
Double Studs used with two Fig. 996 and two Fig. 997.

Fig.	Nickel Plated Per 100	Chromium Plated Per 100
991	\$31.00	\$35.00
994	24.00	28.00
995	26.50	30.50
996	3.50	6.50
997	2.00	5.00
998	33.50	37.50

## New "LIFT THE DOT" FASTENER KIT



Fig. 134

A transparent plastic box containing 100 each of the following "Lift the Dot" Fasteners in nickel plated finish.

Fig.	Fig.	Fig.
60	114	117
62	115	118
90	116	156

Kit Complete Each	Dimensions Box Inches	Weight Pounds
\$85.00	11x6 $\frac{1}{2}$	6 $\frac{1}{2}$

With chromium plated fasteners, price on application.

## "Lift The Dot" FASTENERS ALL BRASS—WITH BRASS SCREW



**STUD**  
With Wood Screw  
Single Fig. 114  
Double Fig. 115



**STUD**  
For Machine Screw  
Single Fig. 156



**SOCKET**  
Single Fig. 116  
Double Fig. 117

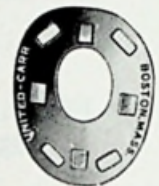

**Clinch Plate**  
Fig. 118



**Clinch Stud**  
Single Fig. 60  
Double Fig. 61



**Clinch Washer**  
Fig. 62



**STUD**  
With Tapping Screw  
Single Fig. 90

Stud Figs. 114, 115 has brass  $\frac{1}{2}$ " No. 8 wood screw.

Stud Fig. 156 is tapped for No. 6-32 screw.

Stud Fig. 90 has steel  $\frac{3}{8}$ " No. 8 self-tapping screw.

Single Studs are used with one Fig. 116 and one Fig. 118.

Double Studs are used with two Fig. 117 and two Fig. 118.

Fig.	Nickel Plated Per 100	Chromium Plated Per 100
60	\$ 6.75	\$ 9.60
61	14.25	17.50
62	2.00	4.85
90	7.50	10.50
114	17.25	20.50
115	18.75	21.75
116	9.75	13.50
117	10.00	14.00
118	2.00	5.00
156	16.50	19.50

Note—Price of Fig. 156 does not include machine screw, just the tapped stud only.

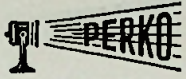

## "Durable Dot" FASTENERS ALL BRASS—WITH BRASS SCREW



Button  
Fig. 896



Eyelet  
Fig. 907



Socket  
Fig. 898



STUD  
With Wood Screw  
Fig. 900



STUD  
With Tapping Screw  
Fig. 906



STUD  
With Machine Screw  
Fig. 917



STUD  
For Canvas  
Fig. 901

Stud Fig. 900 has brass 1/2" No. 6 wood screw.  
Stud Fig. 906 has steel 3/8" No. 7 self-tapping screw.  
Stud Fig. 917 has brass 8-32 machine screw 3/8" long.  
For canvas to wood, use Figs. 896, 898 and 900.  
For canvas to canvas, use Figs. 896, 898, 901 and 907.

Fig.	Nickel Plated Per 100	Chromium Plated Per 100
896	\$3.00	\$ 6.00
898	2.25	5.25
900	7.00	10.00
901	1.30	4.25
906	5.75	8.50
907	1.30	4.25
917	6.50	9.00

## CURTAIN or GROMMET HOOKS CAST BRASS

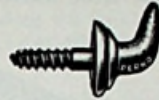

Fig. 1000

Plain Brass Per Dozen  
\$2.80

Diam. Flange Inches  
5/8

Length Screw Inches  
1/2

## GROMMET HOLE CUTTERS FORGED STEEL



Fig. 903

No.	Each	Diam. Hole Inches
0	\$2.60	1/4
1	2.60	3/8
2	3.25	1/2
3	3.25	5/8
4	3.25	3/4
5	5.60	7/8
6	5.60	1

## SENIOR GROMMET DIES FORGED STEEL

Style B for inserting Spur Grommets  
Style C for inserting Washer and Teeth Grommets



Fig. 902

Size No.	Style B Each	Style C Each	Weight Each Lbs.
0	\$ 7.25	\$ 7.25	1 1/4
1	7.40	7.40	1 3/8
2	7.60	7.60	1 3/4
3	7.80	7.80	1 7/8
4	9.00	9.00	2 1/8
5	10.50	10.50	2 3/8

Use a wooden mallet with these dies.

## HAND SET TOOL FOR ABOVE BUTTONS AND EYELETS STEEL



Fig. 905 ..... Each \$1.70

## HAND PUNCH FOR ABOVE CURTAIN FASTENERS CAST IRON WITH STEEL CUTTERS



Fig. 284 ..... Each \$9.25

## HAND PUNCH FOR "LIFT THE DOT" FASTENERS CAST IRON WITH STEEL CUTTERS



Fig. 285 ..... Each \$4.00

## HAND SCREW DRIVER FOR "LIFT THE DOT" STUDS STEEL WITH WOOD HANDLE



Fig. 290 ..... Each \$3.25



## Stainless Steel "Hy-Gear" Marine HOSE CLAMPS

EXTRA WIDE BAND—NO RIVETS—NO WELDS

**HIGH SPEED** — Goes on with hose in position. . . . Safety collar on screw keeps screw driver from slipping.



**HIGH POWER** — Gear-drive principle assures positive, leak-proof seal under all conditions.

Fig. 5200

18-8 STAINLESS STEEL BAND AND HOUSING WITH CADMIUM PLATED SCREW.

Fig. 6400

100% ALL 18-8 STAINLESS STEEL BAND. HOUSING AND SCREW.

Fig. 5200		Size Hose Inches		Clamp Diameter Inches		Box Quantity	Weight Per 100 in Pounds	Fig. 6400	
Part Number	Price Per 100	From	To	Min.	Max.			Part Number	Price Per 100
\$5210	\$32.00	3/8	5/8	3/8	1 1/8	10	6	*6410	\$45.00
5212	33.00	3/8	3/4	1 1/8	1 1/4	10	6	6412	46.00
5216	33.00	3/4	1	1 3/8	1 1/2	10	7	6416	46.00
*5220	34.00	1	1 1/4	1 3/8	1 3/4	10	7	*6420	47.00
*5228	35.00	1 1/4	1 3/4	1 3/8	2 1/4	10	8	*6428	49.00
*5236	37.00	1 3/4	2 1/4	1 3/8	2 3/4	10	9	*6436	51.00
5244	40.00	2 1/4	2 3/4	2 3/8	3 1/4	10	9	6444	54.00
5252	43.00	3	3 1/4	2 3/8	3 3/4	50	11	6452	57.00
5256	43.00	3 1/4	3 1/2	3 1/8	4	50	11	6456	57.00
5264	46.00	3 1/2	4	3 1/8	4 1/2	50	12	6464	61.00

\*The most popular stock sizes.

## Universal Marine HOSE CLAMPS

ALL 18-8 STAINLESS STEEL OR ELECTRO GALVANIZED STEEL WITH ZINC PLATED SCREW

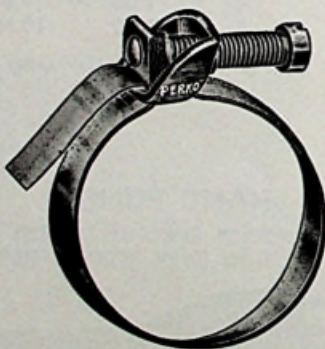

Fig. 499

INSTANTLY ADJUSTABLE FOR ANY SIZE HOSE UP TO 6 INCH

These two sizes do the job of eight or more sizes necessary when ordinary hose clamps are used.

These may be used for larger sizes of hose by joining two or more clamps together, used in this way the size range is practically unlimited.

No.	Stainless Steel Each	Electro Galvanized Each	Length Open Inches	Width Strap Inches	Box Quantity	Weight Ounces
1	\$.55	\$.14	12	1/2	50	1 1/2
2	.70		18	1/2	50	2

Size No. 1 shipped unless otherwise specified.

## "STOCKIT"

STAINLESS STEEL "HY-GEAR" HOSE CLAMPS IN COUNTER DISPLAY



Fig. 5200-S  
Fig. 6400-S

A combination display and stock holder of permanent steel construction, clear plastic bins, stocked with 100 clamps in the four most popular sizes.

Fig. 5200-S Contents		Fig. 6400-S Contents	
20	#5210	20	#6410
20	#5220	20	#6420
40	#5228	40	#6428
20	#5236	20	#6436
Complete — \$35.00		Complete — \$49.75	



## CLOUD FORMATIONS AND SYMBOLS

1. **Cirrus, (Ci.)**—Detached clouds, delicate and fibrous looking, taking the form of feathers, generally of a white color, sometimes arranged in belts which cross a portion of the sky in great circles, and, by an effect of perspective, converging toward one or two opposite points of the horizon.
2. **Cirro-Stratus, (Ci-S.)**—A thin, whitish sheet, sometimes completely covering the sky and only giving it a whitish appearance, or at others presenting, more or less distinctly, a formation like a tangled web. This sheet often produces halos around the sun and moon.
3. **Cirro-Cumulus, (Ci-Cu.)**—Small globular masses or white flakes, having no shadows, or only very slight shadows, arranged in groups and often in lines.
4. **Alto-Cumulus, (A-Cu.)**—Rather large globular masses, white or grayish, partially shaded, arranged in groups or lines, and often so closely packed that their edges appear confused. The detached masses are generally larger and more compact at the center of the group; at the margin they form into finer flakes. They often spread themselves out in lines in one or two directions.
5. **Alto-Stratus, (A-S.)**—A thick sheet of gray or bluish color, showing a brilliant patch in the neighborhood of the sun or moon, and which, without causing halos, may give rise to coronae. This form goes through all the changes like the Cirro-Stratus, but its altitude is only half as great.
6. **Strato-Cumulus, (S-Cu.)**—Large globular masses or rolls of dark cloud, frequently covering the whole sky, especially in winter, and occasionally giving it a wavy appearance. The layer of Strato-Cumulus is not, as a rule, very thick, and patches of blue sky are often visible through the intervening spaces. All sorts of transitions between this form and the Alto-Cumulus are noticeable. It may be distinguished from Nimbus by its globular or rolled appearance and also because it does not bring rain.
7. **Nimbus, (N.)**—Rain clouds; a thick layer of dark clouds, without shape and with ragged edges, from which continued rain or snow generally falls. Through the openings of these clouds an upper layer of Cirro-Stratus or Alto-Stratus may almost invariably be seen. If the layer of Nimbus separates into shreds or if small loose clouds are visible floating at a low level underneath a large Nimbus, they may be described as Fracto-Nimbus (Fr.-N.), the "scud" of sailors.
8. **Cumulus, (Cu.)**—Woolpack clouds; thick clouds of which the upper surface is domeshaped and exhibits protuberances, while the base is horizontal. When these clouds are opposite the sun the surfaces usually presented to the observer have a greater brilliance than the margins of the protuberances. When the light falls aslant, they give deep shadows; when, on the contrary, the clouds are on the same side as the sun, they appear dark with bright edges. The true Cumulus has clear superior and inferior limits. It is often broken up by strong winds, and the detached portions undergo continual changes. These may be distinguished by the name of Fracto-Cumulus (Fr.-Cu.).
9. **Cumulo-Nimbus, (Cu.-N.)**—The thunder-cloud or shower-cloud; heavy masses of clouds rising in the form of mountains, turrets, or anvils, generally having a sheet or screen of fibrous appearance above, and a mass of clouds similar to Nimbus underneath. From the base there usually fall local showers of rain or of snow (occasionally hail or soft hail).
10. **Stratus, (S.)**—A horizontal sheet of lifted fog; when this sheet is broken up into irregular shreds by the wind or by the summits of mountains, it may be distinguished by the name of Fracto-Stratus (Fr.-S.).
11. **Fracto-Stratus, (Fr.-S.)**—A horizontal sheet of lifted fog broken into irregular shreds by wind or the summits of mountains.
12. **Fracto-Cumulus, (Fr.-Cu.)**—Cumulus, when broken up by strong winds, undergo continued changes. These are distinguished by the name of Fracto-Cumulus (Fr.-Cu.).

## RULES OF THE ROAD

- A power boat gives way to a sail boat except when being overtaken.
- Power boats meeting head on pass portside to portside, unless signaled otherwise.
- Any vessel being overtaken by another has the right of way.
- Any vessel having right of way shall hold her course and speed, unless such action would cause a collision.
- The danger zone is from dead ahead to two points abaft the starboard beam.
- Any power boat having another in its danger zone shall give way to the other and shall, if necessary, alter course, slacken speed, stop or reverse.
- A vessel (under 65 ft.) using both sail and power, acts as a power boat by day, but as a sail boat by night.
- A sail boat running free gives way to the one close hauled.
- A sail boat running free with the wind on the port, gives way to one running free with the wind on the starboard.
- A sail boat close hauled with wind on the port, gives way to one close hauled with wind on the starboard.
- When two sail boats are running alike, the one to the windward gives way.

## WHISTLE SIGNALS FOR POWER BOATS

- A vessel's rights cannot be altered by whistle signals, the one which whistles first gains no rights over another, cross signals are unlawful.
- If the signal is correct for the circumstances, answer it, if it is not give the danger signal, stop, and come to an understanding.
- 1—Short blast—I wish to leave you on my port.
  - 2—Short blasts—I wish to leave you on my starboard.
  - 3—Short blasts—My engines are going astern. I am doing my best to stop.
  - 4—Short blasts—Danger, stop, your signals are not clear or are not satisfactory to me.
  - 4—Long blasts—Raise the bridge.
- Whistle signals are never given to or by a sail boat.

## FOG SIGNALS FOR POWER BOATS

- 1—Long blast—I am under way.
- 1—Long and 2 Short blasts—I am towing something.

## FOR HORN SIGNALS FOR SAIL BOATS

- 1—Short blast—I am on the starboard tack.
  - 2—Short blasts—I am on the port tack.
  - 3—Short blasts—I am running free.
  - 1—Long and 2 Short blasts—I am being towed (any vessel).
- Rapid bell—I am at anchor (any vessel).



## INDEX OF FIGURE NUMBERS

Figure Number	Page	Figure Number	Page	Figure Number	Page	Figure Number	Page
0-1	26	69	26	138	65	211	169
0-2	25	72	56	139	144	212	90
0-4	27	73	113	140	144	213	80
0-5	27	75	96	141	49	214	115
0-6	25	77	61	142	137	215	133
0-8	28	78	96	143	57	216	54
0-9	28	79	113	144	91	217	50
0-10	26	80	43	145	19	218	129
0-40	27	81	74	146	85	219	129
0-50	27	82	134	147	82	220	129
0-80	28	83	18	148	155	221	129
0-90	28	84	34	149	75	222	58
1	26	85	55	150	150	223	132
3	26	86	96	151	82	224	132
4	29	87	143	152	84	225	50
5	29	88	143	153	65	226	132
8	62	89	24	154	145	227	70
9	31	90	90	155	75	228	70
11	25	91	24	156	178	229	138
12	25	92	24	157	98	230	63
15	58	93	113	158	169	231	63
17	29	94	63	159	150	232	15
18	29	95	144	160	121	233	131
19	29	96	144	161	121	234	166
20	29	97	22	162	149	235	166
21	35	98	22	163	59	236	165
22	44	99	22	164	59	237	79
23	35	100	143	165	59	238	123
24	62	101	143	166	159	238-A	123
25	65	102	95	167	149	239	79
26	59	103	19	168	49	240-A	68
27	51	104	19	169	169	241	67
28	51	105	54	172	127	242	63
29	40	106	61	176	22	243	169
30	34	107	143	177	91	244	106
31	40	108	82	178	173	245	63
32	34	109	174	179	96	246	63
35	42	110	169	181	92	247	17, 61
37	151	111	168	182	123	248	17, 61
38	168	112	18	183	83	249	61
39	42	113	18	184	51	250	61
40	151	114	178	186-P	61	251	61
42	59	115	178	187	116	252	106
43	142	116	178	188	116	253	106
44	31	117	178	189	106	255	54
45	165	118	178	190	137	256	60
46	30	119	120	191	55	257	61
47	151	120	174	192	168	258	22
48	25	121	59	193	169	259	60
49	30	122	135	194	144	260	60
50	42	123	135	195	144	261	60
51	142	124	80	196	161	262	63
54	142	125	41	198	168	263	81
55	142	126	41	199	127	264	63
58	48	127	44	200	83	265	90
59	40	128	49	201	84	266	81
60	178	129	35	202	83	267	63
61	178	130	65	203	79	268	70
62	178	131	65	204	79	269	60
63	42	132	61	205	79	270	58
64	95	133	61	206	79	271	92
65	95	134	178	207	165	272	63
66	96	135	65	208	79	273	150
67	96	136	19	209	79	274	64
68	43	137	49	210	90	275	149





# Perkins Marine Lamp & Hardware Corp. 183

Figure Number	Page	Figure Number	Page	Figure Number	Page	Figure Number	Page
276	58	345	85	416	68	492	132
278	109	346	58	417	145	493	117
279	144	347	92	419	79	495	16
280	144	349	149	420	150	496	16
281-P	61	350	95	421	17	497	168
282	65	351	153	422	17	498	133
283	67	352	111	423	57	499	180
284	179	353	111	424	57	500	160
285	179	354	110	425	57	501	160
286	64	355	59	426	161	502	132
287	64	356	92	427	128	503	137
288	65	357	93	428	19	504	24
289	65	358	138	429	70	505	24
290	179	359	139	430	76	507	13
291	64	360	134	431	122	508	13
292	64	361	125	432	133	510	76
293	64	362	19	433	70	511	119
294	52	363	81	434	99	512	137
295	111	364	72	435	146	513	76
296	52	365	74	436	128	514	53
297	69	366	145	437	66	517	53
298	111	367	74	438	17	518	53
299	117	368	74	439	17	519	53
300	167	369	74	440	68	520	136
301	51	370	167	441	99	521	18
302	63	372	71	442	99	522	160
303	122	373	73	443	99	523	160
304	50	374	73	445	167	524	102
306	68	375	18	446	129	525	132
307	147	376	72	447	129	526	136
308	50	378	112	450	50	527	79
309	19	379	133	452	66	528	136
310	55	380	133	453	168	529	69
311	95	381	55	454	66	531	15
312	49	382	159	456	79	532	62
314	156	383	52	457	79	533	135
315	156	385	52	459	159	540	30
316	54	386	80	461	99	541	30
317	98	387	80	462	13	542	30
318	166	388	85	463	13	543	153
319	163	389	112	464	117	544	118
320	113	390	158	465	168	544-A	118
321	78	391	158	466	157	546	120
322	95	392	158	467	91	547	135
323	78	393	158	468	157	551	140
324	78	394	158	469	157	552	140
325	96	395	121	470	39	553	140
326	117	396	159	471	168	555	52
327	112	397	123	472	58	556	175
328	111	398	159	473	91	557	152
329	18	400	128	474	39	559	154
330	18	401	123	475	154	561	23
331	109	402	92	476	12	562	142
332	95	403	31	477	57	563	23
333	161	404	17	478	12	564	140
334	72	405	58	479	99	565	141
335	85	406	128	480	53	566	118
336	85	408	39	481	154	567	170
337	62	409	110	481-A	154	568	159
338	156	410	80	482	99	569	159
339	156	411	147	483	145	572	119
340	62	412	129	488	19	573	170
342	129	413	133	489	19	574	173
343	129	414	60	490	132	575	176
344	153	415	129	491	17	576	148

# 184 Perkins Marine Lamp & Hardware Corp.

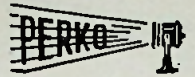

Figure Number	Page	Figure Number	Page	Figure Number	Page	Figure Number	Page
577	114	661	103	733	64	814	127
578	121	662	86	734	113	815	105
579	141	666	86	735	64	816	104
581	150	667	134	736	64	817	128, 155
582	64	668	134	737	81	818	104
583	119	669	152	737-A	81	819	113
584	170	670	152	738	115	820	102
586	93	671	114	740	90	822	109
588	64	672	114	741	122	823	93
589	114	673	114	742	87	825	93
590	148	674	102	743	87	826	136
593	139	675	102	744	76	828-D	94
594	139	676	57	745	54	829-D	94
595	75	677	91	746	59	830	93
596	25	678	102	747	58	831	93
596-A	25	679	111	748	87	832	93
597	122	680	163	749	59	833	94
599	139	681	84	750	122	834	94
600	17	682	89	751	59	835	94
602	153	683	89	753	52	836	94
604	61	684	89	754	138	836-A	94
605	13	685	89	756	146	837	146
606	162	686	71	758	176	838	98
607	123	687	14	759	145	839	177
608	122	688	54	760	138	841	171
609	14	689	86	765	163	842	162
610	177	690	103	766	161	844	94
611	140	691	110	767	161	845	94
612	162	691-A	110	768	175	846	94
613	162	692	111	770	177	847	110
614	133	693	71	771	77	848	110
615	133	694	57	772	175	849	94
617	139	695	103	773	175	850	118
618	160	696	88	774	176	851	118, 124
619	160	697	134	775	125	852	120, 124
620	160	698	108	777	177	853	124
621	160	699	108	778	75	854	124
622	161	700-A	166	779	163	855	94
623	161	700-B	166	780	88	856	94
624	161	700-C	166	781	88	857	138
625	15	701	82	782	77	861	128
628	115	702	82	783	78	862	128
630	71	704	81	784	163	865	107
634	141	705	81	785	163	873	157
635	177	706	71	786	57	877	142
636	110	707	70	787	114	881	142
637	110	708	71	788	131	882	142
638	130	709	81	789	112	887	157
639	130	711	108	791	75	891	146
640	162	712	127	792	107	895	119
641	131	713	127	793	107	896	179
642	131	714	81	794	131	897	97
643	130	714-A	81	796	97	898	179
644	130	715	109	797	176	900	179
645	131	716	109	798	155	901	179
646	131	717	152	799	155	902	179
648	131, 154	718	54	803	97	903	179
649	105	719	177	804	155	904	110
651	105	720	108	805	96	905	179
652	130	721	81	806	97	906	179
655	96	722	81	807	97	907	179
656	163	723	83	809	112	908	77
657	104	727	90	810	105	909	94
659	162	728	90	811	113	910-A	21
660	14	732	138	813	104	910-B	21



# Perkins Marine Lamp & Hardware Corp. 185

Figure Number	Page	Figure Number	Page	Figure Number	Page	Figure Number	Page
911-A	21	1007	42	1117	148	1230	16
912-A	21	1008	38	1118	149	1231	125
913-A	21	1009	151	1121	148	1232	10
914	103	1010	41	1134	37	1233	13
915	146	1011	43	1135	37	1234	125
916	146	1012	44	1136	37	1235	11
917	179	1013	38	1137	37	1236	10
921	147	1014	38	1138	23	1237	51
922	147	1015	147	1139	23	1238	125
923	147	1016	82	1140	10	1239	16
924	174	1017	121	1141	11	1240	120
925	173	1018	82	1144	11	1241	140
926	122	1019	115	1145	15	1242	142
927	170	1020	123	1146	10	1243	139
928	170	1021	116	1147	11	1244	125
929	175	1022	164	1148	16	1245	136
932	138	1023	48	1150	32	1246	135
933	164	1024	48	1151	32	1247	11
936	77	1025	48	1152	32	1248	119
938	20	1028	165	1153	32	1249	121
939	164	1029	85	1154	32	1250	118, 124
940	137	1030	119	1155	33	1252	56
941	164	1032	48	1156	33	1253	120, 124
946	109	1034	47	1157	33	1254	124
947	172	1040	91	1158	33	1255	139
948	173	1041	162	1159	33	1256	139
949	171	1042	162	1160	8	1257	101
951	174	1043	126	1163	31	1258	129
952	174	1044	126	1164	36	1259	129
953	174	1045	48	1165	36	1260	9
954	99	1050	126	1166	36	1261	139
955	175	1051	171	1167	36	1266	51
956	172	1052	172	1168	36	1269	124
957	172	1053	172	1169	36	1270	100
958	173	1054	172	1170	36	1271	100
959	177	1056	173	1171	36	1272	100
960	170	1058	174	1175	147	1273	126
961	112	1059	175	1176	145	1274	9
967	153	1062	78	1178	173	1276	13
968	56	1063	172	1179	176	1277	141
969	56	1064	172	1180	134	1278	20
970	56	1065	173	1200	101	1279	20
971	56	1067	165	1205	8	1280	20
974	56	1068	167	1206	12	1281	20
976	103	1069	78	1207	133	1282	20
977	155	1070	106	1208	133	1283	20
978	149	1071	106	1209	14	1284	126
979	175	1073	106	1210	46	1285	22
982	35	1082	65	1211	46	1286	22
983	34	1087	39	1212	46	1287	141
985	35	1088	105	1213	47	1288	140
986	34	1089	105	1214	47	1289	162
991	178	1090	39	1215	47	1290	134
992	152	1092	114	1216	141	1291	134
994	178	1097	112	1217	125	1292	123
995	178	1100	154	1218	9	1293	13
996	178	1101	171	1221	125	1295	50
997	178	1102	171	1222	125	5200	180
998	178	1103	171	1223	120	5200-S	180
1000	179	1105	171	1224	127	6400	180
1001	38	1106	177	1225	126	6400-S	180
1002	38	1108	172	1226	138		
1003	38	1110	171	1227	130		
1005	41	1111	176	1228	130		
1006	43	1116	134, 176	1229	125		



## ALPHABETICAL INDEX

A		B		B	
	PAGE		PAGE		PAGE
Acorn Nuts .....	168	Riding .....	122	Bridge Lights .....	40 to 44
Adapters —		Blinker —		Bulbs, Electric .....	62
Bow Eye .....	123	Signal Keys .....	31	Bulkhead Lanterns .....	30
Electric .....	58, 59, 64, 65	Signal Lights .....	31	Buoy Holders, Ring .....	121
Oil Lamp .....	48	Blocks —		Buoy Rods .....	159
Adjusters —		Cheek .....	144	Buoys —	
Casement .....	176	Deck .....	143, 144	Mooring .....	166, 167
Hatch .....	176	Fast Eye .....	142	Pickup .....	166
Windshield .....	134, 176	On Plates .....	143	Burners —	
Alcohol —		Swivel Eye .....	143	For Alcohol Stoves .....	74
Burners .....	74	Blower & Ignition Switches .....	75	Oil .....	63
Stove Parts .....	74	Blowers .....	75	Butt Hinges .....	174
Stoves .....	72	Boarding Ladders .....	152	Buttons —	
Aligners, Engine .....	112	Boarding Step .....	153	Door .....	173
Anchor Chocks .....	164	Boat —		Horn Push .....	149
Anchor Lift Leaders .....	145	Bailers .....	80	Watertight Push .....	149
Anchor Lights .....	20, 21, 25 32 to 36, 39	Cleats .....	118, 119		
Anchor Shackles .....	156	Cover Sockets .....	121	C	
Anchors —		Drainers .....	80	Cabin —	
Danforth .....	166	Hook Holders .....	132	Door Hooks .....	172
Fishing .....	165	Hooks .....	132	Fixtures .....	50, 51
Grapnel .....	165	Hooks with Pole .....	132	Heaters .....	75
Navy Type .....	165	Scrapers .....	147	Lamps, Oil .....	49
Non-Fouling Kedge .....	165	Snaps .....	162	Windows .....	97, 98
Northill .....	165	Top Fittings .....	121	Cabinet Hinges .....	175
Anti-Rattlers, Sash .....	177	Trailer Light .....	57	Cabinet Latches .....	172
Arresters, Flame .....	117	Bolts —		Cable —	
Ash Trays .....	155	Barrel .....	172	Outlets .....	57
Axe Brackets .....	96	Cupboard .....	171	Straps .....	59
		Eye .....	160	Cables, Flexible Control .....	108
		Flush .....	172	Can Holder .....	155
		For Steering Wheels .....	103	Cans, Oil .....	117
B		Ring .....	160	Caps, Gas Tank .....	136
Bailers, Boat .....	80	Ship .....	172	Casement Adjusters .....	176
Ball Joints .....	107	Square Neck .....	172	Casing —	
Bands, Eye .....	161	Toggle .....	161	Bowden .....	111
Barge Lights .....	38	Books, Log .....	71	Clamps .....	111
Basins .....	92, 93	Bow —		Catches —	
Basin Pumps .....	91	Chocks .....	120, 121, 124	Cupboard .....	171
Battery —		Eye Adapter .....	123	Elbow .....	173
Boxes .....	127	Eyes .....	122, 123	Flush Ring .....	171
Container .....	127	Lifting Handles .....	124, 125	Friction .....	173
Light Assembly .....	11, 16	Lights .....	8 to 11, 20 to 24 26 to 29	Caulking Irons .....	147
Lights 10, 11, 16, 25, 38, 39 .....		Rings .....	123	Chain —	
Switches .....	55	Bowden —		Deck Pipe .....	122
Bearings —		Wire & Casing .....	111	Plates .....	159
Babbitt .....	112	Wire Clamps .....	111	Portlight .....	99
Flat .....	112	Bowl, Toilet .....	93	Roller .....	102
Goodrich Rubber .....	116	Boxes —		Rowlock .....	130
Stern .....	113, 116	Battery .....	127	Shackles .....	156
Belaying Pins .....	145	Stuffing .....	105, 113, 114	Steerers .....	102
Bells —		Watertight Connection .....	56	Chair —	
Fog .....	150	Braces, Rudder .....	106	Fishing .....	154
Smoke .....	49	Bracket Steerers .....	102	Folding Helmsman's .....	157
Bilge Pump —		Brackets —		Channel, Glass Run Window .....	99
Parts .....	79	Axe .....	96	Chart Cases .....	71
Switches .....	86, 87	Light .....	65	Check Valve .....	90
Bilge Pumps —		Mounting .....	65	Cheek Blocks .....	144
Brass .....	82 to 85	Table .....	155	Chimneys .....	63
Electric .....	86, 87, 88	Breakdown Lights .....	32 to 36	Chocks —	
Steel .....	84			Anchor .....	164
Bits —				Rope .....	120, 121, 124
Mooring .....	122				



## ALPHABETICAL INDEX

C		C		D	
	PAGE		PAGE		PAGE
<b>Choke Controls</b> .....	111	Rod Sockets .....	111	Latches, Sliding .....	170
<b>Clam Shell Ventilators</b> .....	78	Wire Handles .....	111	Stops .....	173
<b>Clamps —</b>		Wire Sockets .....	111	<b>Drain Fittings for Sink</b> .....	93
Bowden Casing .....	111	<b>Controls —</b>		<b>Drain Plugs</b> .....	80, 81
Hose .....	114, 180	Clutch .....	108	<b>Drainers, Automatic Boat</b> .....	80
Spring .....	132	Remote .....	111	<b>Draw Bridge Lights</b> .....	42
Tiller Rope .....	138	Reverse Gear .....	109	<b>Drawer —</b>	
<b>Cleaners, Windshield</b> .....	135	Spark & Throttle .....	109, 110	Knobs .....	173
<b>Cleats</b> .....	118, 119, 124	Throttle .....	108, 109, 110	Pulls .....	173
<b>Clips —</b>		<b>Converter, Oil Lamp</b> .....	48	<b>Drip Moulding</b> .....	168
Line Support .....	59	<b>Convertible Boat Top Fittings</b> .....	121	<b>Drop Handles</b> .....	176
Wire Rope .....	161	<b>Couplings —</b>		<b>Drum Steerers</b> .....	103
<b>Closets —</b>		Flange .....	112		
Bowls .....	94	Moulding .....	168	<b>E</b>	
Parts .....	94	"Pipe to Hose" .....	90	<b>Elbow Catches</b> .....	173
Seats .....	94	Shaft .....	112	<b>Electric —</b>	
<b>Closets, Boat</b> .....	94	<b>Course Protractors</b> .....	71	Adapters .....	58, 59, 64, 65
<b>Clutch Controls</b> .....	108	<b>Cowl Ventilators</b> .....	76	Bilge Pumps .....	86, 87, 88
<b>Clutch Control Handle</b> .....	109	<b>Crank Case Pumps</b> .....	85	Bulbs .....	62
<b>Coaming Pulleys</b> .....	139	<b>Cranks, Control</b> .....	110	Cabin Fixtures .....	50, 51
<b>Coat &amp; Hat Hooks</b> .....	177	<b>Cuddy Door Hinges</b> .....	174	Connections .....	59
<b>Cockpit Step</b> .....	153	<b>Cupboard —</b>		Connectors .....	59
<b>Cocks, Sea</b> .....	94	Bolts .....	171	Horns .....	148, 149
<b>Collars —</b>		Catches .....	171	Plugs .....	59
Electrolysis .....	106	Door Holder .....	173	Safety Main .....	55
Rudder .....	105	Turns .....	171	Sirens .....	148, 149
Shaft .....	114	<b>Cups, Grease</b> .....	112	Sockets .....	57, 58
<b>Color Shield</b> .....	65	<b>Curtain —</b>		Switches .....	54, 55, 56
<b>Combination Bow Lights</b> 8, 9, 10	11, 24, 26	Fasteners .....	178, 179	Water Faucets .....	90
<b>Combination —</b>		Hooks .....	179	Water System Pump .....	87, 88
Bitt & Rope Deck Pipes .....	122	<b>Cutless Rubber Bearings</b> .....	116	<b>Electrolysis —</b>	
Blinker & Loading Light .....	31	<b>Cutters, Grommet Hole</b> .....	179	Collars .....	106
Bow Light for Sail Boats .....	11, 26			Eliminators .....	106
Flag Pole & Light .....	12 to 16	<b>D</b>		<b>Ends, Moulding</b> .....	168
Light & Searchlight .....	68	<b>Danforth Anchors</b> .....	166	<b>Engine Aligners</b> .....	112
<b>Companionway Step</b> .....	153	<b>Dart Shanks</b> .....	96	<b>Exhaust —</b>	
<b>Compass Light</b> .....	70	<b>Darts, Sword Fish</b> .....	96	Blowers .....	75
<b>Connecting Links</b> .....	163	<b>Dashboard —</b>		Pipe Flanges .....	115
<b>Connection Box</b> .....	56	Choke Controls .....	111	Tube Flanges .....	115
<b>Connections —</b>		Lamps .....	51	<b>Eye —</b>	
Electric .....	59	Steerers .....	100, 101	Bands .....	161
Inlet .....	95	<b>Deck —</b>		Bolts .....	160
Outlet .....	95	Blocks .....	143, 144	Nuts .....	168
Thru-Hull .....	95	Irons .....	76	Straps .....	142
Watertight .....	56, 57	Lights .....	98	<b>Eyes —</b>	
<b>Connectors —</b>		Pipes, Rope & Chain .....	122	Bow .....	122, 123
Double Contact .....	59	Plate Keys .....	136	Flange .....	142
Electric .....	59	Plates .....	79, 136	Halyard .....	15
Fused Line .....	57	Straps .....	142	Lacing .....	161
Ship to Shore .....	56	<b>Dies, Grommet</b> .....	179	Transom Lifting .....	159
<b>Containers —</b>		<b>Distress Lights</b> .....	31		
Battery .....	127	<b>Dividers</b> .....	71	<b>F</b>	
Oil .....	117	<b>Dock Line Springs</b> .....	145	<b>Fairleaders, Thru-Deck</b> .....	146
<b>Continuous Hinge</b> .....	169	<b>Dome —</b>		<b>Fans, Exhaust Blowers</b> .....	75
<b>Control —</b>		Glasses .....	61	<b>Fast Eye —</b>	
Cables, Flexible .....	108	Lights .....	51, 52	Blocks .....	142
Cranks .....	110	<b>Door —</b>		Snaps .....	162
Handles, Clutch .....	109	Buttons .....	173	Snap Shackles .....	157
Levers .....	110	Fasteners .....	172	<b>Fastener Kit</b> .....	178
Parts .....	107	Hinges .....	174	<b>Fasteners —</b>	
		Holders .....	173	Curtain .....	178, 179
		Hooks .....	172	Door .....	172
				"Durable Dot" .....	179



## ALPHABETICAL INDEX

F		F		H	
	PAGE		PAGE		PAGE
Hatch	134	Fresnel —		Sliding Window	99
"Lift the Dot"	178	Globes	22, 61	Transom	124, 125
Refrigerator	172	Lenses	60	<b>Hasps —</b>	
Sash	177	Friction Catches	173	Hinged	175
Table Leg	177	Funnels	74	Safety	175
<b>Faucets</b>	90	<b>Fuse —</b>		<b>Hatch —</b>	
<b>Fender —</b>		Holder	59	Adjusters	176
Cleats	118, 119	Panels	57	Fasteners	134
Hooks	135			Hinges	175
Moulding	169			Lifting Handle	176
<b>Fids, Hand</b>	147	<b>G</b>		Lifting Rings	176
<b>Filters Water</b>	117	<b>Galley —</b>		Moulding	168
<b>Fins, Racing</b>	106	Pumps	91	Support Hinges	176
<b>Fishing —</b>		Sinks	92	Trim	169
Anchors	165	<b>Gas —</b>		<b>Heater</b>	75
Chair	154	Stoves	73	<b>Hinged Hasps</b>	175
Pole Holders	154	Stove Equipment	73	<b>Hinges —</b>	
Rod Sockets	154	Strainer	117	Butt	174
<b>Fittings for Boat Tops</b>	121	Tank Caps	136	Butterfly	174
<b>Fixtures —</b>		Tank Vents	137	Cabinet	175
Electric Cabin	50, 51	<b>Gasoline —</b>		Continuous	169
House	47, 48	Funnels	74	Cuddy Door	174
Truck	19	Strainers	117	Flap	175
Vapor-Proof	39	<b>Gear Pumps</b>	89	Hatch	175
<b>Flag Pole —</b>		<b>Glass Holders</b>	155	Hatch Support	176
Clips	15	<b>Glass Run Window Channel</b>	99	Ladder	175
Lights	12 to 16	<b>Glasses —</b>		Port	174
Sockets	129	Dome Light	61	Rail	135
<b>Flag Poles</b>	12 to 16	Fresnel	60	Spring	175
<b>Flag Staffs</b>	16	<b>Globe Lights</b>	31	Strap	174
<b>Flame Arresters</b>	117	<b>Globes</b>	17, 22, 61, 63	<b>Holders —</b>	
<b>Flange —</b>		<b>Goodrich Rubber Bearings</b>	116	Boat Hook	132
Eyes	142	<b>Goosenecks</b>	146	Can	155
Nuts	96	<b>Grab Rail Posts</b>	133	Door	173
<b>Flanges —</b>		<b>Grab Rails</b>	133	For Ring Buoy	121
Exhaust Pipe	115	<b>Grappels</b>	165	Fuse	59
Exhaust Tube	115	<b>Grease Cups</b>	112	Glass	155
<b>Flap Hinges</b>	175	<b>Grommet —</b>		Outrigger Pole	154
<b>Flexo-Shaft Bilge Pumps</b>	86, 87	Dies	179	Pot	74
<b>Floodlights</b>	70	Hole Cutters	179	Spring	132
<b>Flush —</b>		Hooks	179	<b>Hooks —</b>	
Drop Handles	176	<b>Gudgeons, Rudder Brace</b>	106	Boat	132
Hatch Lifting Handles	176	<b>Guides, Tiller Rope</b>	138, 139	Cabin Door	172
Hatch Lifting Rings	176	<b>H</b>		Curtain	178
Pulls	171	<b>Halyard —</b>		Coat & Hat	177
Ring Catch	171	Eyes	15	Fender	135
Ring Pulls	171	Shackles	157	Galvanized	163
<b>Flushing Nozzles</b>	96	<b>Hand —</b>		Grommet	179
<b>Fog Bells</b>	150	Fids	147	Ladder	152
<b>Fog Horns</b>	149	Punches	179	Lashing	121
<b>Folding —</b>		Rail Sockets	133	Rope Ladder	155
Cockpit Step	153	Screw Drivers	179	"S"	163
Foot Rest	153	Searchlight	68	Safety Mooring	162
Ladders	152	Tool	179	Screw	163
Steps	153	Windshield Cleaners	135	Ski Towing	128
Stools	151	<b>Handles —</b>		Snap	168
Table	155	Bow	124, 125	Utility	177
<b>Foot Rest</b>	153	Clutch Control	109	Wardrobe	177
<b>Foot Rope Plates</b>	159	Drop	176	<b>Horn Push Button</b>	149
<b>Founts, Oil</b>	64, 65	For Control Wire	111	<b>Horns —</b>	
<b>Frames for Sink</b>	92	For Steering Wheels	103	Electric	148
		Hatch Lifting	176		

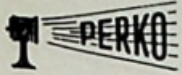

## ALPHABETICAL INDEX

H		L		L	
	PAGE		PAGE		PAGE
Fog	149	Lavatories —		Twenty-One Day	
Hose Clamps	114, 180	China	93	Battery Anchor	25
Hose, Rubber	79, 114	Lucite	93	Whistle, Signal	37
House Fixtures	47, 48	Lead Lines	137	Yardarm	19
Hull Connections	95	Leaders, Anchor Lift	145	Line Support Clips	59
<b>I</b>		Leads, Sounding	137	Liners, Rubber	154
Ignition Switches	54	Leathers, Oar	131	Lines, Lead	137
Ignition & Blower Switches	75	<b>Lenses —</b>		Links —	
Inlet —		Fresnel	60	Connecting	163
Connections	95, 96	Searchlight	70	Lap	163
Strainers	95, 96	Levers, Control	110	Swing	163
International Lights	20, 21, 22	Life Boat Lantern	30	Locker Ventilators	78
Irons —		Lift Bridge Lights	44	Locknuts	113
Caulking	147	Lifting Rings	129, 176	Locks —	
Water Deck	76	Lighting Switches	54	Ladder	152
<b>J</b>		Lights —		Mortise	170
Jam Cleats	119	Anchor	20, 21, 25	Rail	135
Jib Snaps	163		32 to 36, 39	Rim	170
Joints —		Battery	10, 11, 16	Tubular	170
Ball	107		25, 38, 39	Log Books	71
Universal	113	Blinker	31	Logs, Shaft	114
<b>K</b>		Bow	8, 9, 10, 11	<b>M</b>	
Kedge Anchors	165		20 to 24, 26 to 29	Manila Rope Thimbles	157
Keel Plates	129	Breakdown	32 to 36	Marline Spikes	147
Keys —		Bridge	40 to 44	Masts, Streamlined	151
Blinker	31	Combination	8 to 11, 24, 26	Mast Lights	18, 19, 31
Deck Plate	136	Combination Light & Searchlight	68	Masthead Lights	20 to 24
Kits —		Compass	71		32 to 36, 38
Name Plate	53	Deck	98	Meal & Absent Lights	18
Fastener	178	Distress or Globe	31	Mid-Channel Lights	43
Knobs, Drawer	173	Dome	51, 52	Mirrors, Rear View	128
<b>L</b>		Double Lens	36	Mogul Sockets	58
Lacing Eyes	161	Flag Pole	12 to 20	Mooring —	
Ladder —		Flood	70	Bits	122
Hinges	175	Globe	31	Buoys	166, 167
Hooks	152, 155	International	20 to 22	Hook, Safety	162
Locks	152	Lift Bridge	44	Mortise Locks & Latches	170
Ladders —		Loading	31	Motor Boat Regulations	7
Boarding	152	Mast	18, 19, 31	Moulding —	
Folding	152	Masthead	20, 21, 32, to 36, 38	Couplings	168
Rope	152	Meal & Absent	18	Drip	168
Swimming	152	Mid-Channel	43	Ends	168
Lamps —		Not-Under-Command	32 to 36	Fender	169
Cabin	49	Obstruction	41	Hatch	168
Dashboard	51	Overtaken	32 to 36	Rub Rail	169
Table	46, 47	Pier	40, 41	Rubber	168, 169
Wall	49	Pole	12 to 20	Mounting Brackets	65
Lanterns —		Range	20, 21, 32 to 36, 38	Mounting Sockets	65
Bulkhead	30	Sail Boat	11, 26	<b>N</b>	
Navy or Life Boat	30	Side	20 to 29, 32 to 36, 38	Name Plate Kit	53
Lap Links	163	Signal	30, 31, 37	Name Plates, Switch	53
Lashing Hooks	121	Sixty-Day Anchor	39	Navy —	
Latches —		Span	42, 43, 44	Anchors	165
Cabinet	172	Spreader	70	Bilge Pumps	82
Mortise	170	Stern	12 to 21, 32, 36, 38	Lanterns	30
Push-Pull	170	Ten-Day Anchor	25	Northill Anchors	165
Rim	170	Thirty-Day Anchor	39	Not-Under-Command Lights	32 to 36
Sliding Door	170	Towing	30 to 36	Nozzles, Flushing	96
Lavatory Pumps	91	Trailer	57	Nut Eye Bolts	160
		Trawler	39	Nut Ring Bolts	160



## ALPHABETICAL INDEX

N		P		P	
	PAGE		PAGE		PAGE
<b>Nuts —</b>		<b>Plastic Whistles</b>	149	<b>Punches —</b>	
Acorn	168	<b>Plates —</b>		Grommet Hole	179
Eye	168	Chain	159	Hand	179
Flanged	96	Deck	79, 136		
Lock	113	Foot Rope	159		
Packing	113	Keel	129		
Wing	168	Step	126		
		Switch Name	53		
		Transom	127		
<b>O</b>		<b>Plugs —</b>			
<b>Oar —</b>		Drain	80, 81		
Leathers & Buttons	131	Electric	59		
Locks	130, 131	Watertight	56		
Sleeve, "Sav-or"	131	<b>Plungers, Pump</b>	79		
Tips	131	Pole Holders, Boat Hook	132		
<b>Obstruction Lights</b>	41	Pole Holders, Outriggers	154		
<b>Oil —</b>		<b>Pole Lights</b>	12 to 20		
Containers	117	<b>Pole Sockets</b>	154		
Founts	64, 65	<b>Poles, Flag</b>	12 to 16		
Lamp Converter	48	<b>Port Hinges</b>	174		
Pump	85	<b>Portlight —</b>			
<b>Oilers, Zinc</b>	117	Chains	99		
<b>Outboard Motor Transom</b>		Rubber	99		
Plates	127	Screens	99		
<b>Outboard Steerers</b>	100, 101	<b>Portlights</b>	97, 98		
<b>Outlet Connections</b>	95	<b>Ports, Rudder</b>	105		
<b>Outlets —</b>		<b>Posts —</b>			
Cable	57	Grab Rail	133		
Water	95	Stanchion	133		
<b>Outrigger Pole Sockets</b>	154	<b>Pot Holders</b>	74		
<b>Overtaken Lights</b>	32 to 36	<b>Protractors, Course</b>	71		
		<b>Pulleys —</b>			
<b>P</b>		Coaming	139		
<b>Packing Nuts</b>	113	Swivel Eye	140, 141		
<b>Paddle Tips</b>	131	Tiller Rope	140, 141		
<b>Pads —</b>		Tiller Rope with Snap	140, 141		
Step	126	Wire Rope	144		
Transom	127	<b>Pulls —</b>			
<b>Paint Scraper</b>	147	Drawer	173		
<b>Palms, Sewing</b>	147	Flush	171		
<b>Panels —</b>		Flush Ring	171		
Switch	53	<b>Pump —</b>			
Fuse	57	Parts	79		
<b>Parallel Rules</b>	71	Plungers	79		
<b>Parts —</b>		Strainers	81		
Bilge Pump	79	Switches	86, 87		
Control	107	Valves	79		
Gear Pump	89	<b>Pumps —</b>			
Steerer	103, 107	Basin	91		
Stove	74	Bilge	82 to 88		
Toilet	93	Crankcase	85		
<b>Pennants, Wind</b>	146	Electric	86, 87, 88		
<b>Piano Hinge</b>	169	Flexo-Shaft	86, 87		
<b>Pick-Up Buoys</b>	166	Galley	91		
<b>Pier Lights</b>	40, 41	Gear	89		
<b>Pins —</b>		Lavatory	91		
Belaying	145	Navy	82		
Brass	145	Oil	84		
<b>Pintles, Rudder Brace</b>	106	Rotoflex	88		
<b>Pipe —</b>		Water, Electric	87, 88		
Flanges	115	Wing	84		
Turnbuckles	159				
<b>Pipes, Rope Deck</b>	122				

### Q

**Quadrants, Tiller** 105

### R

**Racing Fin** 106

**Rail —**

Fittings 135

Hinge 135

**Range Lights** 20, 21, 32 to 38

**Receptacles, Watertight** 56

**Reflectors, Searchlight** 69

**Refrigerator Fasteners** 172

**Regulations for Motor Boats** 7

**Relays** 150

**Reverse Gear Controls** 109

**Riding Bitts** 122

**Rigging Turnbuckles** 159

**Rim Locks** 170

**Ring —**

And Deck Straps 123

Bolts 160

Buoy Holders 121

Catches, Flush 171

Lifting 129, 176

On Plate 123

Pulls 171

**Rings —**

Bow 123

Brass 145

Hatch Lifting 176

Lifting 129

Ventilator 79

**Rods, Buoy** 159

**Roller Chain** 102

**Rope —**

Clamps 138

Clips 161

Deck Pipe 122

Guides 138, 139

Ladder Hooks 155

Ladders 152

Thimbles 157

Tighteners 138

Tiller 138

**Roping Palms** 147

**Rowlocks** 130, 131

**Rub Rail Moulding** 169

**Rubber —**

Bearings 116

For Portlights 99

For Windshields 135

Hose 79, 114

Liners for Outriggers 154

Moulding 168, 169

Step Pads 126

Step Plates 126

Transom Pads 127





## ALPHABETICAL INDEX

R		S		S	
	PAGE		PAGE		PAGE
<b>Rudder —</b>		<b>Signal Lights</b>	30, 31, 37	<b>Chocks</b>	120, 121
Braces	106	<b>Sink Frames</b>	92	Lights	12 to 21, 32 to 38
Collars	105	<b>Sinks, Galley</b>	92	Pole Lights	12 to 20
Gudgeons	106	<b>Sirens, Electric</b>	148, 149	<b>Stools, Folding</b>	151
Ports	105	<b>Skags, Rudder</b>	105	<b>Stops, Door</b>	173
Shoes	105	<b>Ski Towing Hooks</b>	128	<b>Stoves —</b>	
Skags	105	<b>Skylight Fasteners</b>	177	Alcohol	72
Stuffing Boxes	105	<b>Sleeve, Oar</b>	131	Bottled Gas	73
<b>Rudders</b>	104	<b>Smoke Bell &amp; Arm</b>	49	Burners	74
<b>Rules, Parallel</b>	71	<b>Snaps —</b>		Funnel	74
		Baby	162	Parts	74
		Fast Eye	162	<b>Strainers —</b>	
		Jib	163	Gasoline	117
		Swivel Eye	162	Inlet	95, 96
<b>"S" Hooks</b>	163	<b>Sockets —</b>		Pump	79, 81
<b>Safety Main Switch</b>	55	Boat Cover	121	Round	96
<b>Sail Boat Bow &amp; Side Lights</b>	11, 26	Control Rod	111	Sink	93
<b>Sail Thimbles</b>	157	Control Wire	111	Water	117
<b>Sailmakers Palms</b>	147	Electric	57, 58	<b>Strap Hinges</b>	174
<b>Sash —</b>		Fishing Rod	154	<b>Straps —</b>	
Anti-Rattlers	177	Flag Pole	129	Cable	59
Fasteners	177	Hand Rail	133	Deck	142
<b>"Sav-or", Oar Sleeves</b>	131	Mounting	65	Eye	142
<b>Scoop Strainers</b>	96	Outrigger Pole	154	<b>Struts, Adjustable</b>	115
<b>Scrapers —</b>		Watertight	57	<b>Stuffing Boxes</b>	105, 113, 114
Boat	147	Wire Rope	146	<b>Stuffing Box Locknuts</b>	113
Double End	147	<b>Sounding Leads</b>	137	<b>Stuffing Box Packing Nuts</b>	113
Paint	147	<b>Span Lights</b>	42 to 44	<b>Swing Links</b>	163
<b>Screens, Portlight</b>	99	<b>Spare Parts for Bridge &amp; Pier Lights</b>	45	<b>Switch —</b>	
<b>Screw —</b>		<b>Spark &amp; Throttle Controls</b>	109, 110	Name Plate Kit	53
Drivers	179	<b>Spikes, Marline</b>	147	Name Plates	53
Eye Bolts	160	<b>Spotlights</b>	66 to 69	Panels	53
Hooks	163	<b>Spotlight Unit</b>	70	<b>Switches —</b>	
Ring Bolts	160	<b>Spreader Floodlight</b>	70	Battery	55
<b>Scupper, Cockpit</b>	137	<b>Spring —</b>		Bilge Pump	86
<b>Sea Cocks</b>	94	Clamps	132	Blower & Ignition	75
<b>Sealed Beam Spotlight Unit</b>	70	Hinges	175	Electric	54, 55
<b>Seaming Palms</b>	147	<b>Springs for Dockline</b>	145	Ignition	54
<b>Searchlight —</b>		<b>Springs, Tiller Rope</b>	138	Pump	86
Bulbs	62	<b>Staffs, Flag</b>	16	Safety Main	55
Lenses	70	<b>Stanchions</b>	133	Starter	54, 55
Reflectors	69	<b>Starter Switches</b>	54	Toggle	54
<b>Searchlights</b>	66 to 69	<b>Steerer Parts</b>	103, 107	Watertight	56
<b>Seats, Toilet</b>	94	<b>Steerers —</b>		<b>Swivel —</b>	
<b>Shackles —</b>		Bracket	102	Eye Blocks	143
Anchor	156	Chain	102	Eye Mooring Hook	162
Chain	156	Dashboard	100, 101	Eye Pulleys	140, 141
Halyard	157	Drum	103	Eye Snaps	162
Snap	157	Geared	102	Fishing Chair	154
<b>Shades for Cabin Fixtures</b>	51	Outboard	100, 101	Shackles	157
<b>Shaft —</b>		Runabout	100, 101	<b>Swivels</b>	161
Collars	114	<b>Steering Wheels</b>	100 to 104	<b>Sword Fish Darts</b>	96
Couplings	112	<b>Steps —</b>			
Logs	114	Boarding	153	<b>T</b>	
<b>Shanks, Dart</b>	96	Cockpit	153	<b>Table Brackets</b>	155
<b>Sheaves, Rope</b>	145	Folding	153	<b>Table, Folding</b>	155
<b>Shields —</b>		<b>Step Plates</b>	126	<b>Table Lamps</b>	46, 47
Color	65	<b>Stern—</b>		<b>Table Leg Fasteners</b>	177
For Fixtures	51	Bearings	113, 116	<b>Tail Pieces</b>	96
For Int'l Lights	12, 13			<b>Tank —</b>	
<b>Ship to Shore Connectors</b>	56			Caps	136
<b>Side Lights</b>	20 to 29, 32 to 38			Vents	137



## ALPHABETICAL INDEX

T		T		W	
	PAGE		PAGE		PAGE
<b>Thimbles —</b>		Rigging .....	159	<b>Windshield —</b>	
Manila Rope .....	157	Turns, Cupboard .....	171	Adjusters .....	134, 176
Sail .....	157			Cleaners .....	135
Wire Rope .....	157	<b>U</b>		Keeper & Plate .....	134
<b>Throttle Controls</b> 108, 109, 110		<b>Universal Joints</b> .....	113	Rubber .....	135
<b>Thru-Deck Fairleaders</b> .....	146			Wipers .....	135
<b>Thru-Hull Connections</b> .....	95	<b>V</b>		<b>Wing Nuts</b> .....	168
<b>Tiller —</b>		<b>Valves, Check</b> .....	90	<b>Wing Pumps</b> .....	84
Rope .....	138	<b>Valves, Pump</b> .....	79	<b>Wire —</b>	
Rope Clamps .....	138	<b>Vapor-Proof Fixtures</b> .....	39	Bowden .....	111
Rope Guides .....	138, 139	<b>Ventilator Deck Plates</b> .....	79	Rope Clips .....	161
Rope Pulle: .....	140, 141	<b>Ventilators —</b>		Rope Pulleys .....	144
Rope Tighteners .....	138	Clam Shell .....	78	Rope Sockets .....	146
<b>Tillers</b> .....	105	Cowl .....	76	Rope Thimbles .....	157
<b>Tips —</b>		Cruiser .....	77	Tiller Rope .....	138
Oar .....	131	Gas Tank .....	137	<b>Worm Geared Steerers</b> .....	102
Paddle .....	131	Locker .....	78		
<b>Toggle Bolts</b> .....	161	Space Saver .....	77	<b>Y</b>	
<b>Toggle Switches</b> .....	54	Streamline .....	77, 78	<b>Yardarm Lights</b> .....	19
<b>Toilet —</b>		Transom .....	78		
Bowl .....	93	Turbine .....	76	<b>Z</b>	
Parts .....	93			<b>ZAMAK ITEMS —</b>	
Seats .....	93	<b>W</b>		<b>Adjuster, Windshield</b> .....	134
<b>Toilets</b> .....	94	<b>Wall Lamps</b> .....	49	<b>Bow Eye</b> .....	123
<b>Tools, Hand</b> .....	179	<b>Wardrobe Hooks</b> .....	177	<b>Caps, Gas Tank</b> .....	136
<b>Towing —</b>		<b>Water —</b>		<b>Chocks</b> .....	120, 124
Hooks .....	128	Deck Irons .....	76	<b>Clamps, Tiller Rope</b> .....	138
Lights .....	30, 32 to 36	Faucets .....	90	<b>Cleats</b> .....	118, 119, 124
<b>Trailer Light</b> .....	57	Outlet .....	95	<b>Fixtures, Cabin</b> .....	50
<b>Transom —</b>		Ski Towing Hooks .....	128	<b>Guides, Tiller Rope</b> .....	139
Drain Plugs .....	80	Strainers .....	117	<b>Handles</b> .....	124, 125
Handles .....	124, 125	<b>Watertight —</b>		<b>Hooks, Fender</b> .....	135
Lifting Eyes .....	159	Bilge Pumps .....	86, 87	<b>Hooks, Lashing</b> .....	121
Pads .....	127	Blinker Keys .....	31	<b>Latch, Cabin Door</b> .....	170
Plates .....	127	Cable Outlets .....	57	<b>Lights —</b>	
Pole Lights .....	14	Connection Box .....	56	Bow .....	8 to 11, 20
Ventilators .....	78	Connections .....	57	"International" .....	20 to 22
<b>Trawler Lights</b> .....	39	Dome Lights .....	51	Pole .....	12, 13, 16
<b>Trays, Ash</b> .....	155	Push Buttons .....	149	Side .....	20, 22
<b>Trim, Hatch</b> .....	169	Receptacles .....	56	<b>Plates —</b>	
<b>Truck Fixtures</b> .....	19	Ship Lights .....	32 to 36, 38	Step .....	126
<b>Tube Flanges</b> .....	115	Switches .....	56	Transom .....	127
<b>Tubular Lock Sets</b> .....	170	<b>Wheels, Steering</b> ...	100 to 103	<b>Pulleys, Tiller Rope</b> .....	140, 141
<b>Turbine Ventilators</b> .....	76	<b>Whistle Signal Light</b> .....	37	<b>Rowlocks</b> .....	130
<b>Turnbuckles —</b>		<b>Whistles</b> .....	149	<b>Snaps, Boat</b> .....	162
Bronze .....	159	<b>Wicks</b> .....	63	<b>Sockets —</b>	
Open .....	158	<b>Wind Pennants</b> .....	146	Boat Cover .....	121
Petite .....	159	<b>Window Channel</b> .....	99	Flag Pole .....	129
Pipe .....	159	<b>Window Handle, Sliding</b> .....	99	<b>Straps, Eye</b> .....	142
		<b>Windows</b> .....	97, 98	<b>Windshield Adjusters</b> .....	134, 176

24-

