

# PERKO®

"The difference is distinctive"



CATALOG NO. 230



# PERKO, INC.

Factory and Main Office  
16490 Northwest 13th Avenue  
P.O. Box 64000D  
Miami, Florida 33164

Telephone  
Area Code 305-621-7525

Cable Address  
"PERKO" Northmiamiflorida

Telex No. 51 9658

*Manufacturer of SHIP AND BOAT EQUIPMENT  
NAVIGATION LIGHTS  
MARINE HARDWARE  
FOR ALL SIZES AND TYPES OF VESSELS*



## CATALOG NO. 230



SECTION — A  
LIGHTS FOR VESSELS  
UNDER 65 FEET

SECTION — B  
LIGHTS FOR VESSELS  
OVER 65 FEET

SECTION — C  
ELECTRIC SWITCHES  
INDICATOR LIGHTS  
ELECTRIC LAMPS, ETC.

SECTION — D  
LIGHTING FIXTURES

SECTION — E  
SEARCHLIGHTS

SECTION — F  
BLOWERS, VENTS  
VENTILATORS

SECTION — G  
SINKS, PORTLIGHTS,  
WINDOWS, BELLS, ETC.

SECTION — H  
STEERING EQUIPMENT  
STRAINERS, FILTERS  
UNDERWATER FITTINGS  
PUMPS, DRAINERS

SECTION — I  
DECK HARDWARE  
CLEATS, CHOCKS,  
BOW EYES  
RAIL FITTINGS

SECTION — J  
CABINET &  
DOOR HARDWARE  
LOCKS, HINGES, ETC.

SECTION — K  
FISHING  
EQUIPMENT

SECTION — L  
SKIN PACK

SECTION — M  
"CHROMALEX®" III  
LIGHTS & HARDWARE

SECTION — N  
INDEXES

## GENERAL INFORMATION

**PRICES AND TERMS** — Our costs are subject to change due to causes beyond our control. The prices listed herein are only intended for guidance of our jobbers and do not necessarily establish resale prices. Applicable governmental regulations, shipping costs and other complications should be considered in arriving at a fair price. All prices are subject to change without notice. Terms are 30 days net; 2% if payment is sent 10 days from date of invoice. Orders from firms unknown to us and having no satisfactory commercial credit rating must be accompanied by cash or satisfactory references. C.O.D. shipments will be made if a 25% deposit is sent with order.

**SALES POLICY** — PERKO Products are sold through our established Distributors. We do not sell direct to the public or organizations not entitled to trade recognition. Therefore, possession of this catalog does not infer an offer to sell. Please contact your local marine supplier.

### ONE-YEAR LIMITED WARRANTY

PERKO, INC. (PERKO) warrants to the original consumer purchaser that PERKO's consumer products will be free from defective materials or workmanship, under normal use and service, for a period of one (1) year from the original purchase date.

ALL IMPLIED WARRANTIES, INCLUDING MERCHANTABILITY, ARE ALSO LIMITED IN DURATION TO THE ONE YEAR PERIOD FROM THE ORIGINAL PURCHASE DATE. PERKO SHALL NOT BE LIABLE FOR LOSS OR USE OF ANY OF ITS CONSUMER PRODUCTS, NOR SHALL PERKO BE LIABLE FOR OTHER INCIDENTAL OR CONSEQUENTIAL COSTS, EXPENSES, OR DAMAGES INCURRED BY THE ORIGINAL CONSUMER PURCHASER OR BY ANY OTHER PERSON, FIRM OR CORPORATION.

SOME STATES DO NOT ALLOW LIMITATIONS ON HOW LONG AN IMPLIED WARRANTY LASTS, SO THE ABOVE LIMITATION MAY OR MAY NOT APPLY TO YOU. SOME STATES DO NOT ALLOW THE EXCLUSION OR LIMITATION OF INCIDENTAL OR CONSEQUENTIAL DAMAGES, SO THE ABOVE LIMITATION OR EXCLUSION MAY NOT APPLY TO YOU.

This Warranty is void if the consumer product warranted has been damaged by accident or unreasonable use, neglect, improper service or other causes not arising out of defects in material or workmanship. Excluded from this Warranty are Electric light bulbs (Lamps), Sealed Beam Units, Batteries, Fuses and all Sacrificial type Zinc Electrolysis Eliminators.

During the warranty period, your PERKO product will either be repaired or it will be replaced with a like product (at PERKO's option) without charge to the original consumer purchaser, when returned prepaid and insured, with proof-of-purchase date to PERKO at its address as listed below. In the event of replacement, the replacement product will continue the warranty of the original product, or ninety (90) days, whichever is longer. **IMPORTANT: FOR THIS WARRANTY TO BE EFFECTIVE PERKO MUST BE SUPPLIED WITH PROOF -OF-PURCHASE DATE OF THE PRODUCT.**

Perko does not authorize any person or company to create for it any other obligation or liability in connection with any of its products.

This Warranty gives you specific legal rights, and you may also have other rights which vary from State to State.

### DESIGNS

For the purpose of constant improvement in our products, the designs and specifications are subject to change without notice.

### RETURN GOODS

Material made to order is not returnable. Stock material is only returnable when permission has been granted by us, and is subject to a handling and refinishing charge. Shipping charges must be prepaid. Be sure to give date and number of invoice. Permission must be requested within 30 days after receipt of material.

### WEIGHTS

The weights given in this catalog are approximate, but have been carefully determined and should be sufficient for general purposes.

### SHIPPING INSTRUCTIONS

Customers should send specific shipping instructions, if this is not done, we will use our own judgement in selecting route.

### SHIPMENTS

F.O.B. OUR PLANT, MIAMI, FLORIDA, unless quoted otherwise. We are not responsible for damage, loss or delay after goods are delivered to carrier. When loss or delay occurs, we will gladly assist in tracing or expediting, but such assistance is no criterion of responsibility.

When there is LOSS OR APPARENT VISIBLE DAMAGE to a shipment, when tendered for delivery, DO NOT give the carrier a clear receipt. Note such damage on the carrier's delivery receipt and HAVE THE DRIVER SIGN THE RECEIPT.

### CONCEALED DAMAGE OR LOSS

1. Advise the delivering carrier in writing as soon as discovered or at least no more than 15 days after delivery, and request carrier to make an inspection.
2. RETAIN for the carrier's inspection, the CONTAINER and ALL PACKING that the damaged or lost material was packaged in.
3. SHORTAGES — Must be reported to us within 15 days after receipt of goods.

# Directors



**MARVIN S. PERKINS**  
President



**LEROY F. HOLLENBECK**  
Vice President  
Manufacturing



**NATHAN LIPPMAN**  
Secretary & Treasurer



**FREDERICK M. PERKINS**  
Asst. Vice Pres.  
Manufacturing

# Staff



**ALLEN W. MATTHEWS, JR.**  
General Sales Mgr.



**JOHN P. RUSH**  
Asst. Gen'l Sales Mgr.



**JOSE R. MARTINEZ**  
Export  
Sales Mgr.

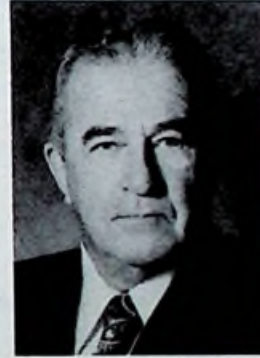

**HARRY B. CODET**  
Asst. Sales Mgr.  
O. E. M. Division



**K. TIMOTHY LePAGE**  
Purchasing-Printing  
Manager



**AUGUSTA S. WOLF**  
Sales



**FRANCES REED**  
Sales



**LINDA SYKES**  
Sales



**JIM HALULA**  
Sales

# Sales Representatives

## PACIFIC AND WESTERN AREA

### McCUNE — WESTERN INC.



**Roland E. McCune**  
Northern California  
148 Sand Hill Circle  
Menlo Park, CA. 94025  
Phone 415 - 854-2594

### JAMES K. DUGAN and ASSOCIATES



**James K. Dugan**  
829 W. 18th St. — Costa Mesa, Calif. 92627  
Phone 714-642-2655  
So. California — Nevada — Arizona  
New Mexico — Hawaii



**Dan A. Naber**



**Wayne R. Mooers**  
Utah — Colorado  
900 No. San Antonio Rd.  
Los Altos, Calif. 94022  
Phone 415 - 941-4323

**John B. Merifield Co. Inc.**  
**Ralph K. Beringer**  
**Tom Harger**  
927 N.W. 50th St.  
P. O. Box 70626  
Seattle, Wash. 98107  
Phone 206 - 789-1800



**Ralph K. Beringer**



**Tom Harger**

Washington  
Oregon  
Idaho  
Montana  
Wyoming  
Br. Columbia  
Alberta  
Alaska

## GULF COAST AREA

**F.F. Tranchina Co., Inc.**

Northern Texas

Southern Louisiana



**Robert F. Tranchin**



**Dick Dickson**



**Girard T. Tranchin**

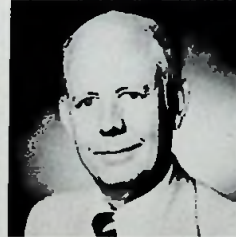

**Joe Bergerren**



**Kyle McHugh**

8100 Sovereign Row  
Dallas, Texas 75247  
Phone 214 - 631-5123

*Tenn.  
Savoy Williamson*



**Jim Tranchin — Tennessee**  
Central & Northern Louisiana

1005 Magazine St.  
New Orleans, La. 70130  
Phone 504 - 524-7451

Alabama — Mississippi

Southern & Central Texas



**Harold Bube**

1121 Regent Drive  
Birmingham, Ala. 35226  
Phone 205 - 822-5851



**Alvin Parker**  
115 Lawrence Drive  
Haughton, La. 71037  
Phone 318 - 949-3727



**Robert J. Bartlett**

509 West Main, Apt. 1  
Houston, Texas 77098  
Phone 713 - 528-7405

**SOUTHERN EAST COAST AREA**

**HENRY S. GARTNER & ASSOCIATES INC.**

South Florida

Central & North Florida

Georgia  
South Carolina – North Carolina



Henry S. Gartner

P.O. Box 1699  
Ft. Lauderdale, Fla. 33302  
Phone 305 - 522-8145



Jack Barnes



George P. Bunnell

P. O. Box 611  
Vero Beach, Fla. 32960  
Phone 305 - 231-1441



Earl V. Aronson

500 Brown Road  
Anderson, So. Car. 29621  
Phone 803 - 226-7752

*Kern Williams*

**EASTERN AREA**

**HERMAN C. OSEROFF & ASSOCIATES**

New York State – Western Pennsylvania

Ohio

Michigan



Herman C. Oseroff

16738 E. Warren Ave. Detroit, Michigan 48224 - Phone 313 - 885-4480



C.R. (Bud) Burt



R. William Burt



Edward J. Sheldon  
4280 St. Paul Blvd.  
Rochester, N.Y. 14617  
Phone 716 - 467-7369

**MID-WEST AREA**

Western Division  
**MIDWESTERN SALES CO.**

Central Division

Missouri – Kansas  
Iowa – Oklahoma  
No. and So. Dakota  
Nebraska



Dennis Wills  
7819 Wornall Road  
Kansas City, Mo. 64114  
Phone 816 - 363-1169



Jim Terrill  
Arkansas  
P.O. Box 113  
Knoxville, Ark. 72845  
Phone 501 - 885-2234



Wm. D. Greene  
730 No. Waukegan Rd.  
P. O. Box 257  
Deerfield, Ill. 60015  
Phone 312 - 945-0545

Illinois – Indiana  
Wisconsin – Minnesota  
Kentucky

**MID-ATLANTIC AREA**

**NEW ENGLAND AREA**

Long Island, N.Y.  
New Jersey – Delaware  
Maryland  
Eastern Pennsylvania

*John Bergbauer*



Raymond J. Murphy  
946 Bayside  
Rockaway Point, N.Y. 11697  
Phone 212 - 474-6933



Wm K. Carswell  
51 Old Road  
Eliot, Maine 03903  
Phone 207 - 439-3623

Maine  
New Hampshire  
Massachusetts  
Rhode Island  
Connecticut

# EQUIPMENT REQUIREMENTS

## FROM U.S. COAST GUARD (CG-290) DATED JULY 1976

### MINIMUM REQUIRED EQUIPMENT BY LENGTH OF BOAT

#### 1. Less Than 16 Feet In Length:

**BACK-FIRE FLAME ARRESTER**—One approved device on each carburetor of all gasoline engines installed after April 25, 1940 EXCEPT OUTBOARD MOTORS.

**VENTILATION**—At least two ventilator ducts fitted with cowls or their equivalent for the purpose of properly and efficiently ventilating the bilges of every engine and fuel tank compartment of boats constructed or decked over after April 25, 1940, using gasoline as fuel and other fuels having a flashpoint of 110° F. or less.

There shall be at least one exhaust duct installed so as to extend to the lower portion of the bilge and at least one intake duct installed so as to extend to a point at least midway to the bilge or at least below the level of the carburetor air intake.

**BELL, WHISTLE**—None.

**PFD**—See "Personal Flotation Devices".

**FIRE EXTINGUISHER/PORTABLE**—When NO fixed fire extinguishing system is installed in machinery space(s):

At least one B-I type approved hand portable fire extinguisher. (NOT REQUIRED on outboard motorboats less than 26 feet in length if the construction of such motorboats will not permit the entrapment of explosive or flammable gases or vapors.) When a fixed fire extinguishing system is installed in machinery space(s), one less B-I type extinguisher is required.

**POLLUTION PREVENTION**: See Water Pollution And The Recreational Boatman.

#### 2. 16 Feet To Less Than 26 Feet In Length:

**BACK-FIRE FLAME ARRESTER**—Same requirements as Section I.

**VENTILATION**—Same requirements as Section I.

**BELL, WHISTLE**—No bell required. One hand, mouth, or power operated whistle, audible at least one-half mile.

**PFD**—See "Personal Flotation Devices".

**FIRE EXTINGUISHER/PORTABLE**—Same requirements as Section I. Same for fixed systems also.

**POLLUTION PREVENTION**: Same as Section I.

#### 3. 26 Feet To Less Than 40 Feet In Length:

**BACK-FIRE FLAME ARRESTER**—Same requirements as Section I.

**VENTILATION**—Same requirements as Section I.

**BELL**—One, which when struck, produces a clear, bell-like tone.

**Whistle**—One hand or power-operated, audible at least 1 mile.

**PFD**—See "Personal Flotation Devices".

**FIRE EXTINGUISHER/PORTABLE**—At least two B-I type approved portable fire extinguishers; or at least one B-II type approved portable fire extinguisher. When an approved fixed system is installed, one less B-I type is required.

**POLLUTION PREVENTION**: Same as Section I.

#### 4. 40 Feet To Not More Than 65 Feet In Length:

**BACK-FIRE FLAME ARRESTER**—Same requirements as Section I.

**VENTILATION**—Same requirements as Section I.

**BELL**—One, which when struck, produces a clear, bell-like tone.

**Whistle**—One power operated, audible at least 1 mile.

**PFD**—See "Personal Flotation Devices".

**FIRE EXTINGUISHER/PORTABLE**—At least three B-I type approved portable fire extinguishers; OR at least one B-I type PLUS one B-II type approved portable fire extinguisher. When an approved fixed system is installed, one less B-I type is required.

**NOTE**: Fire extinguishing equipment requirement for MOTOR VESSELS greater than 65 feet in length can be found in Title 46, Code of Federal Regulations, Part 25 and in the U.S. Coast Guard publication "Rules and Regulations for Uninspected Vessels, Subchapter C" (CG-258).

**POLLUTION PREVENTION**: Same as Section I.

#### Measuring Your Boat For Length

For determining the length of a vessel, the distance is measured in a straight line from the foremost part of the vessel to the aftermost part of the vessel, parallel to the centerline, exclusive of sheer.

Bowsprits, bumpkins, rudders, outboard motors and brackets, and similar fittings or attachments are not to be included in the measurement.



# LIGHT REQUIREMENTS

## FROM U.S. COAST GUARD (CG-290) DATED JULY 1976

### LIGHTS REQUIRED ON BOATS UNDERWAY BETWEEN SUNSET AND SUNRISE

#### VESSELS OF LESS THAN 65 FEET USING INTERNATIONAL WATERS (May be used on Inland waters)

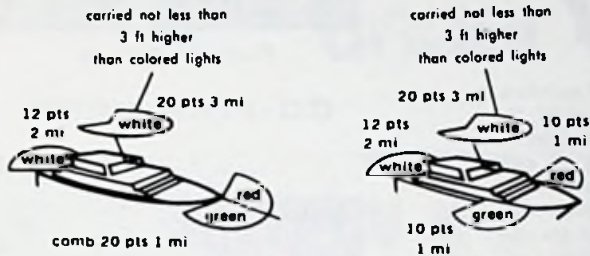

### LIGHTS FOR USE WHEN ANCHORED OR ROWING

**POWER BOATS** under 65 feet and all Sailing Vessels at anchor must display anchor lights except those under 65 feet in "special anchorage areas." An anchor light is a white light visible to a boat approaching from any direction, and is displayed in the fore part of the vessel.

#### LIGHTS FOR ROWING BOATS

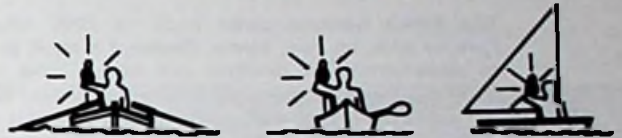

**INTERNATIONAL:** (1) Vessels 40 to less than 65 feet in length must carry 20 point white light 9 feet above gunwale as well as 3 feet higher than colored sidelights. (2) All vessels may display either separate colored sidelights or combined lanterns except vessels under sail alone 40 to less than 65 feet in length must display separate colored sidelights.

**ROWING BOATS:** Rowing boats whether under oars or sail shall have ready at hand a lantern showing a white light which shall be temporarily exhibited in sufficient time to prevent collision.

### VESSELS USING ONLY INLAND WATERS (including Great Lakes and Western Rivers)

#### LESS THAN 26 FEET 26 FEET TO NOT MORE THAN 65 FEET

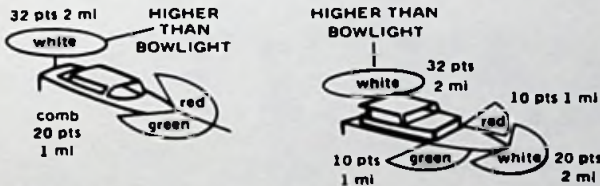

**IMPORTANT: LIGHTS MUST BE PLACED HIGH ENOUGH THAT THEIR LIGHT WILL NOT BE BLOCKED BY PERSONS OR PARTS OF THE BOAT OR ITS EQUIPMENT.**

**DEFINITION:** "10 pts. 1 mi." means that the light can be seen through an arc of 10 points for a distance of 1 mile by another vessel.

### VESSELS UNDER SAIL ALONE

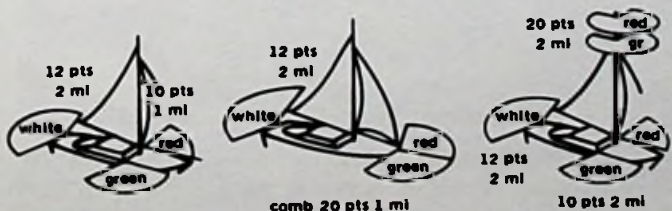

All vessels in Inland and International waters.

Vessels under 40 feet in International waters only.

**OPTIONAL** for all boats in International waters only.

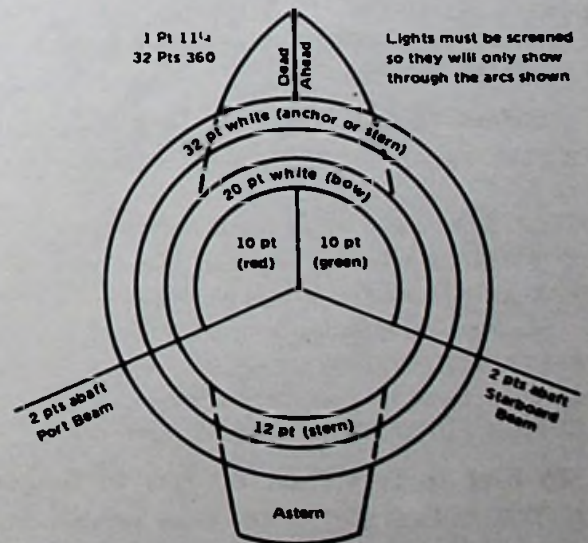

**EXCEPTIONS:** (1) Western River Rules. Sidelights for vessels under sail must be visible for 3 miles. (2) Great Lakes. On the Great Lakes sailing vessels show a white light (in lieu of a stern light) upon that portion of the vessel which is being approached by another vessel.

# PERKO®

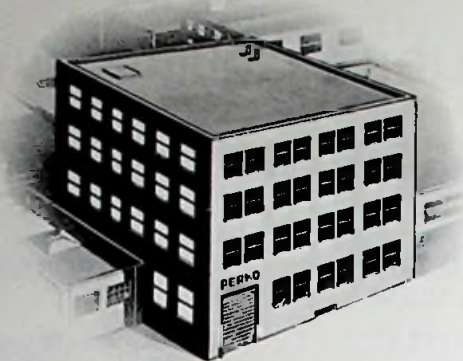

## 1907 - 1977

The Perko heritage dates back to 1907 when the late Frederick Perkins with his son, Louis, founded a small shop in Brooklyn, N. Y. to manufacture oil lanterns and navigational lights for the maritime industry. Soon the quality of their products became recognized and the company prospered to the point where it incorporated in 1917. During the decades to follow, the original Brooklyn shop was expanded many times to keep pace with the growing demand for the ever broadening Perko line. By 1960 further plant expansion was no longer feasible because of property limitations.

At this point the surviving Co-Founder, Louis Perkins, decided to move the entire operations to its present facility in Miami, Florida. He coordinated and supervised the monumental relocation and played a vital role in planning the highly efficient plant layout.

As a result of his vision and determination, all manufacturing facilities in the Miami plant are effectively arranged under one roof. Every step of production from the bronze and die cast foundry to final assembly and inspection is completely coordinated.

Before his passing in 1964, Louis E. Perkins devoted his efforts to making sure his new plant, the most modern in the industry, produced quality products worthy of the Perko name he founded.

The original area of the plant in Miami in 1961 was 90,000 square feet. The total enclosed area is now 150,000 square feet.



Frederick Perkins

### CO-FOUNDERS

Louis E. Perkins

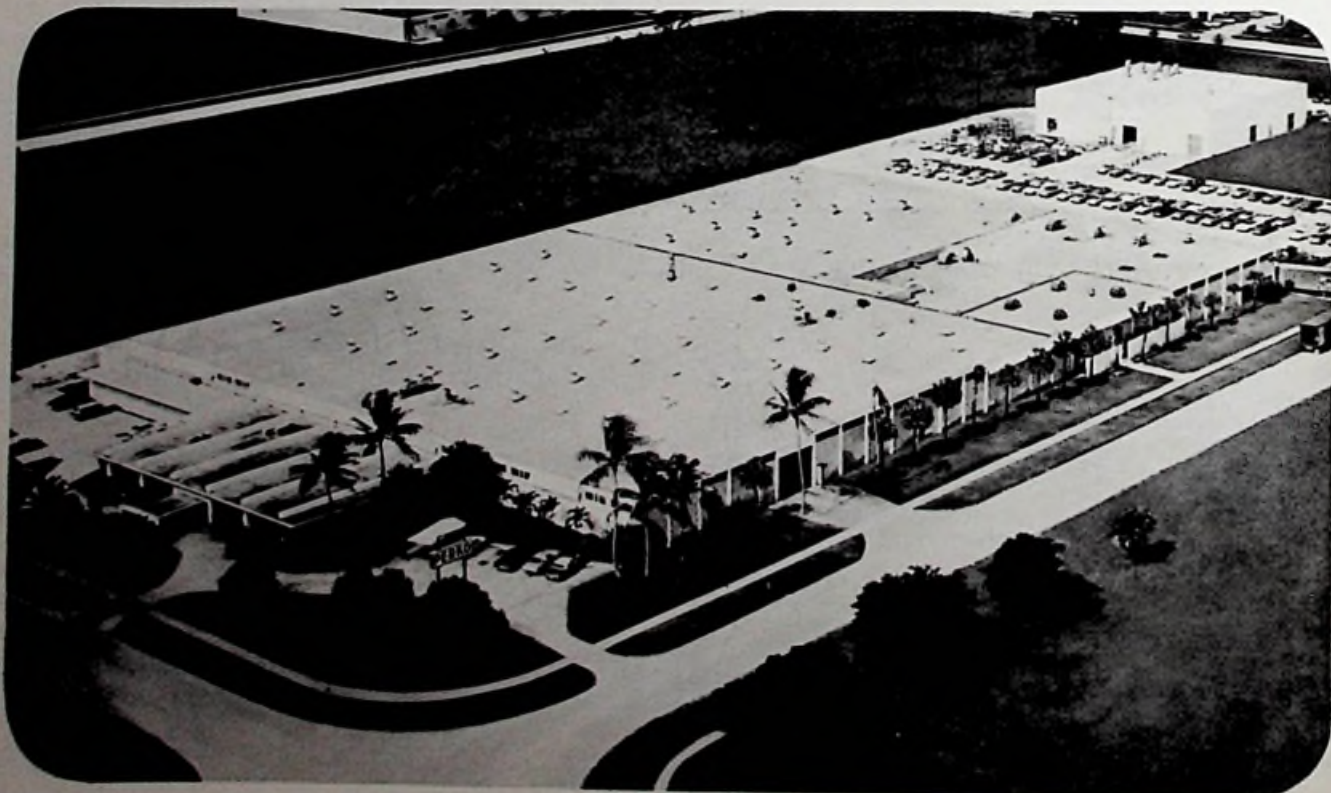

# PERKO®

## Navigation lights for vessels under 65 feet...

### CERTIFIED LIGHTS

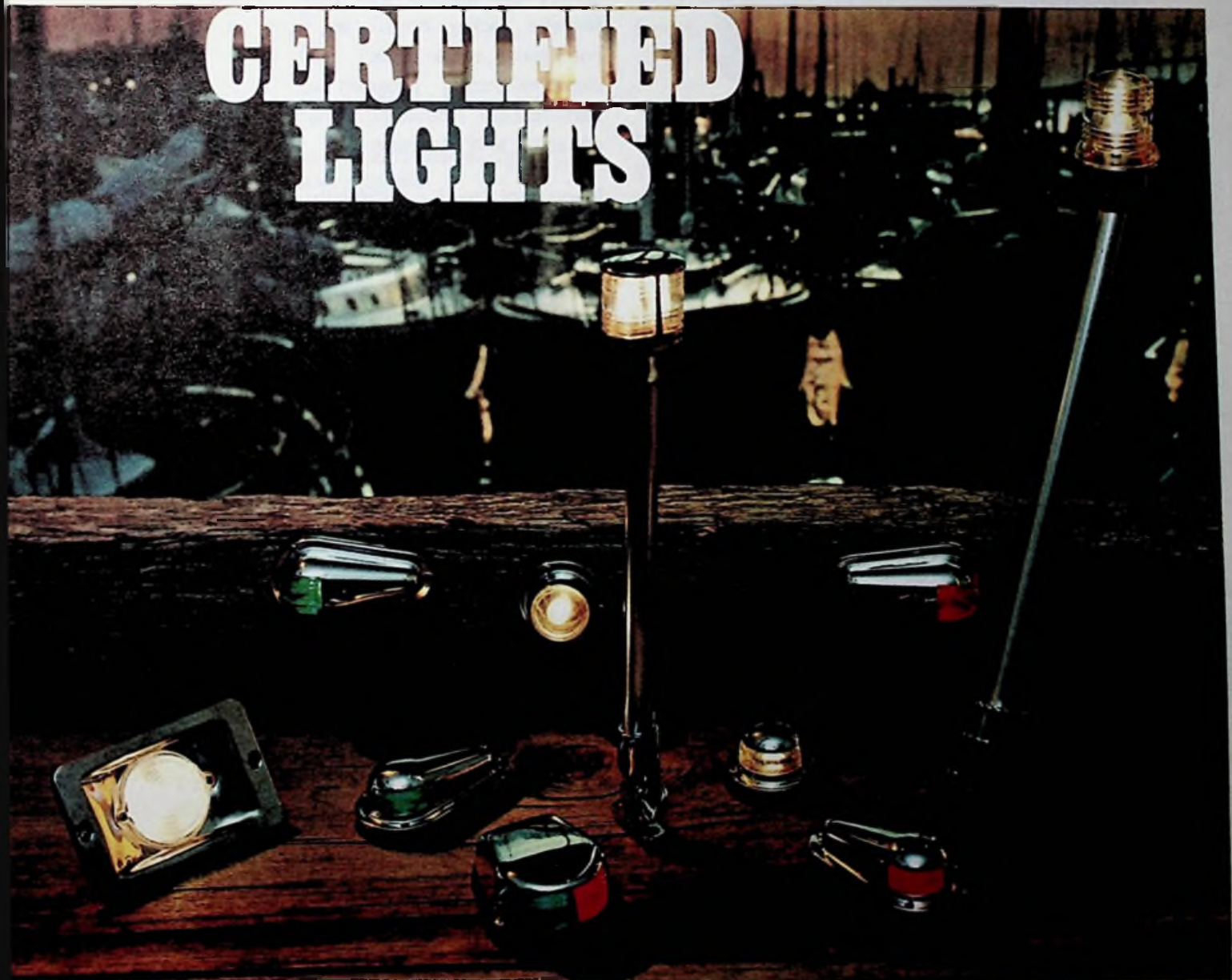

MANUFACTURED BY PERKO, INC., 16490 N.W. 13TH AVE., P.O. BOX 64000-D, MIAMI, FLORIDA 33164

FOR COMPLETE LINE SEE CATALOG NO. 230

© PERKO, INC.  
ALL RIGHTS RESERVED

PORTIONS OF THIS CATALOG PREVIOUSLY  
COPYRIGHTED IN 1936 THRU 1976 INCLUSIVE

## BOAT CERTIFICATION PROCEDURES

BOATING INDUSTRY ASSOCIATION is a national trade association serving all elements of the recreational boating industry.

Its members include manufacturers of all types of boating equipment — outboard and inboard boats, sailboats, marine engines, outboard motors, boat trailers, boating accessories and supplies.

BOATING INDUSTRY ASSOCIATION has developed certification programs to help manufacturers comply with established standards and safety regulations, and to help inform the public of such compliance when purchasing equipment.

In 1968 BIA inaugurated a certification program for boat manufacturers covering horsepower and

load capacity, flotation, steering and fuel systems, compartment ventilation, navigation lights and backfire flame control.

A manufacturer participating in this program must certify all models less than 26 feet in length (except racing boats) as fitted with standard equipment on a model year basis. BIA's boat capacity rating program is incorporated into certification covering load and horsepower capacity and flotation.

Inspectors from a nationally recognized independent testing laboratory visit the manufacturer, check for the BIA capacity and flotation ratings, and physically inspect each model for compliance with all boat certification standards.

### PERKO NAVIGATIONAL LIGHTS TESTED AND SELF CERTIFIED

CERTIFIED
-----------

DURING THE PAST SEVERAL YEARS WE HAVE DEVOTED A GREAT DEAL OF TIME AND EXPENSE TO FIELD AND LABORATORY TESTS IN AN EFFORT TO COMPLY WITH B.I.A. STANDARDS AND TO ENABLE US TO CERTIFY ACCORDINGLY.

WHERE WE INDICATE THAT CERTAIN LIGHTS ARE CERTIFIED, IT MEANS THAT ALL TESTS HAVE BEEN COMPLETED AND IN OUR JUDGEMENT, THE LIGHT COMPLIES WITH B.I.A. STANDARDS.

THEY ARE ALSO DESIGNED AND MANUFACTURED TO MEET THE EXISTING REGULATIONS OF THE U.S. COAST GUARD. •

• CG-290 July 1976

#### ELECTRIC LAMPS (BULBS)

##### 12 Volt — 32 Volt Equivalents

Our Lights Are Supplied With 12 Volt Lamp Installed, Unless Otherwise Indicated.  
32-Volt Lamps Are Supplied as Extra Item But Not Installed In The Light.

##### 12 VOLTS

MFRS. LAMP NO.	PERKO FIG. NO.
90	337 No.11
1004	337 No.12
1142	337 No.13
1144	337 No.14
1416	56 No. 4
212-2	70 No. 1
15-A	340 No. 5
25-A	340 No. 6

##### 32 VOLTS

MFRS. LAMP NO.	PERKO FIG. NO.
624	337 No.18
1228	337 No. 19
1692	337 No.20
1054	337 No.21
1495	56 No. 6
10126	70 No. 2
15-A	340 No.11
25-A	340 No.12

## "CHROMALEX"<sup>®</sup> COMBINATION BOW LIGHTS

PATENT NO. 3,828,714

PERKOPLATE CHROMIUM FINISH — RED AND GREEN HIGH INTENSITY FRESNEL LENSES  
 DELRIN NON-CORROSIVE DOUBLE CONTACT SOCKET — COMPLETE WITH  
 ELECTRIC LAMP INDICATED BELOW

20 POINTS — 225 DEGREES — 1 MILE VISIBILITY  
 CERTIFIED WITH A NO. 1004 LAMP, 12 VOLTS 15 C.P. SUPPLIED WITH LIGHT

Size Base	Height Inches	Screw No.	Weight Ounces
4x3-1/8	1-7/8	8	5-1/2

Fig. 1161 Has Silicon Bronze Housing  
 Mounted on Black Plastic Base  
 Chromium Plated Housing

Each

Fig. 1310 Has Die Cast Zinc Alloy Housing  
 Mounted on Black Plastic Base  
 Chromium Plated Housing

Each

MARK II Has a Black Plastic Insert on Top of  
 Chromium Plated Housing.

Fig. 1410 Has Die Cast Zinc Alloy Housing  
 Mounted On Black Plastic Base.

Each

### MARK I

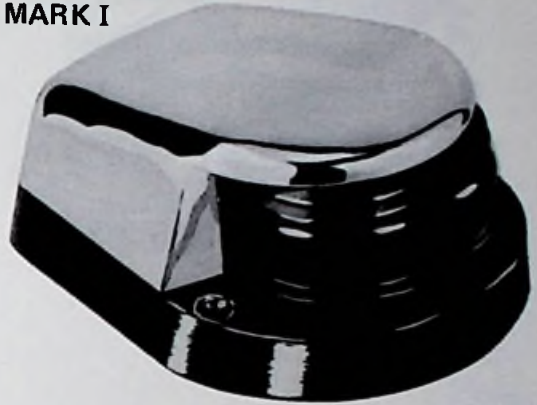

Fig. 1161 — Bronze  
 Fig. 1310 — Zinc Alloy

CERTIFIED

### MARK II

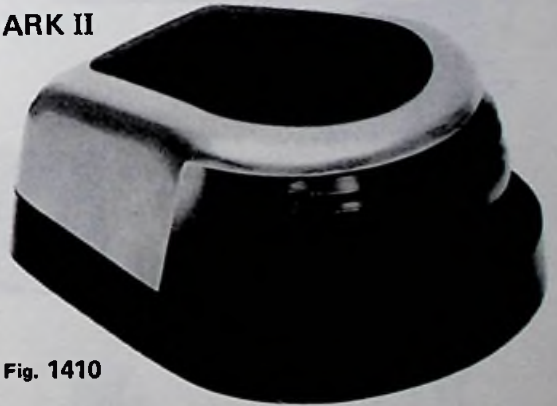

Fig. 1410

CERTIFIED

**NEW** → SEE SECTION "M" FOR NEW "CHROMALEX"<sup>®</sup> III  
 BOW LIGHT

SKIN PACK — Fig. 1310-SP

One Light Per Card  
 Six Cards Per Box  
 Weight Per Box, 2½ Pounds

Sold To Trade In Full Box Only



Fig. 1310-SP

**NEW** → SEE SECTION "L" FOR NEW "CHROMALEX"<sup>®</sup> III  
 SKIN PACKED BOW LIGHT

### SPARE PARTS

Electric Sockets, See Fig. 24 No. 1  
 Lamps or "Bulbs," See Fig. 337 No. 12

Lenses — Red, Specify Fig. 283-R  
 Lenses — Green, Specify Fig. 283-G

**COMBINATION BOW LIGHTS**

**DIE CAST ZINC ALLOY – PERKOPLATE POLISHED CHROMIUM FINISH  
RED AND GREEN FRESNEL LENSES – DELRIN NON-CORROSIVE DOUBLE CONTACT SOCKET  
20 POINTS – 225 DEGREES – 1 MILE VISIBILITY**



**CERTIFIED**

**Fig. 1215**

**THE "FUTURA"—Fig. 1215**

Certified with No. 1004 Bulb, 12 Volts, 15 C.P.  
Supplied with Light.

Assembled With One Bolt Inside Staff Socket

Height Inches	Width Inches	Length Inches	Staff Socket Inches	Weight Pounds
2-3/8	3-3/4	5-1/2	3/4	1-1/4

**Fig. 1215, Each**



**CERTIFIED**

**Fig. 1218**

**THE "RANGER"—Fig. 1218**

Certified with No. 1004 Bulb, 12 Volt, 15 C.P.  
Supplied with Light.

Each	Height Inches	Size Base Inches	Height Lens Inches	Staff Socket Inches	Weight Pounds
	3-3/8	6-1/4x3-7/8	2-1/2	3/4	3/4

**Fig. 1218-SP**



**SKIN PACK – Fig. 1218-SP**

One Light Per Card  
Three Cards Per Box  
Weight Per Box, 4 Pounds

Sold To Trade In Full Box Only



**CERTIFIED**

**Fig. 1146**

**"LITTLE JOE" – Fig. 1146**

**Miniature Bayonet Electric Socket**

Certified with No. 1416 Bulb, 12 Volts, 8 C.P.,  
Supplied with Light.

Each	Height Inches	Base Inches	Height Lens Inches	Staff Socket Inches	Weight Ounces
	2-1/4	4-3/8x2-3/8	1-7/8	1/2	7

**Fig. 1146-SP**

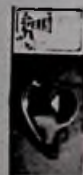

**SKIN PACK— Fig. 1146-SP**

One Light Per Card  
Three Cards Per Box  
Weight Per Box, 1 1/2 Pounds

Sold To Trade In Full Box Only

**SPARE PARTS**

Lenses — Red, For Fig. 1215, Specify Fig. 251-R  
Lenses — Green, For Fig. 1215, Specify Fig. 251-G  
Lenses — Red, For Fig. 1218, Specify Fig. 258-AR  
Lenses — Green, For Fig. 1218, Specify Fig. 258-AG  
Lenses — Red, For Fig. 1146, Specify Fig. 232-R

Lenses — Green, For Fig. 1146, Specify Fig. 232-G  
Electric Sockets For Figs. 1215, 1218, See Fig. 24 No. 1  
Electric Sockets For Fig. 1146, Specify Fig. 1146-99A  
Lamps (Bulbs) For Figs. 1215, 1218, See Fig. 337 No. 12  
Lamps (Bulbs) For Fig. 1146, See Fig. 58 No. 4

### COMBINATION BOW LIGHTS — Figs. 904 and 972

Brass — Polished Chromium Plated — Black Plastic Base  
 20 Points — 225 Degrees — Red and Green Lenses  
 1 Mile Visibility

With Stainless Steel Screws For Mounting.

Certified with No. 1416, 12 Volt, 8 C.P. Bulb Supplied  
 with Light — Brass Miniature Bayonet Type Socket

**Fig. 904**

Each	Length Inches	Width Inches	Height Inches	Weight Ounces
	4	2-1/8	1-3/4	3-1/2

**Fig. 972**

Each	Height Inches	Diameter Base Inches	Diameter Neck Inches	Length Neck Inches	Weight Ounces
	1-5/8	2-3/8	3/4	1/2	3

CERTIFIED

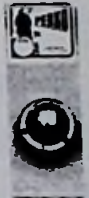

**Fig. 904**



CERTIFIED

**Fig. 972**



**Fig. 972-SP**

### SKIN PACK — Fig. 972-SP

One Light Per Card  
 Four Cards Per Box  
 Weight Per Box, 1 Pound  
 SOLD TO TRADE IN FULL BOX ONLY

### COMBINATION BOW LIGHTS — Figs. 970 and 974

Brass Light with Black Plastic Base  
 Tubing Anodized Aluminum  
 Deck Fittings are Die Cast Zinc Alloy — Polished Chromium Plated  
 20 Points — 225 Degrees — Red and Green Lenses  
 1 Mile Visibility

Certified with No. 1416, 12 Volt, 8 C.P. Bulb Supplied  
 with Light — Brass Miniature Bayonet Type Socket.

Designed for Trolling, Bass Boats etc.

Adjustable or removable when not in use.

When in Fixed Vertical Position, the Light should be seen  
 over the Top of the Electric Trolling Motor.

**Fig. 970**

Light is Removable From Deck Socket for Stowing Away —  
 Makes or Breaks Electric Connection When Inserted or Removed.

Has Waterproof Cap for Opening When Light Is Removed

Each	Height Inches	Diameter Flange Inches	Weight Ounces
	8-1/2	2 1/8	8

**Fig. 974**

Adjustable to Various Angles — Removable or Can Be Laid  
 Down When Not In Use.

Each	Height Overall Inches	Dimensions Base Inches	Weight Ounces
	8-1/2	2 x 5/8	9

CERTIFIED



**Fig. 974**

CERTIFIED

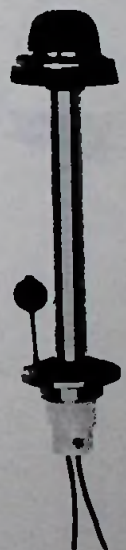

**Fig. 970**

### SPARE PARTS

Lenses—Red, Specify Fig. 286-R.  
 Lenses—Green, Specify Fig. 286-G.  
 Electric Sockets, Specify Fig. 1109

Fig. 974 Bracket Assembly with Thumb Screw and End Cap.  
 Specify Fig. 1120.  
 Lamps (Bulbs), See Fig. 56, No. 4.

### STERN POLE LIGHTS — Fig. 1311

Anodized Aluminum Tube — Die Cast Zinc Top and Base  
 Chromium Plated — Delrin D.C. Socket — with Bulb-Wired  
 Clear High Intensity Fresnel Globe  
 Certified with No. 90, 12 Volt 6 C.P. Bulb  
 32 Points — 2 Mile Visibility

No.	Each	Length Inches	Weight Pounds
2		24	7/8
3		30	1
4		36	1 1/8



### SKIN PACK Fig. 1311 SP

One Light Per Card  
 Five Cards Per Box  
 Weight Per Box 4½ Pounds

Sold To Trade In Full Box Only



### STOW - A - WAY TYPE — Fig. 1330

Same Construction as Fig. 1311

No.	Each	Length Inches	Weight Pounds
2		24	1
3		30	1 1/8
4		36	1 1/4

A Plastic Cap Is Attached To Base To Waterproof  
 The Opening When Pole Is Removed.



### SKIN PACK — Fig. 1330-SP

One Light Per Card  
 Five Cards Per Box  
 Weight Per Box 5 Pounds

Sold To Trade In Full Box Only



### TELESCOPING TYPE — Fig. 1148

Same Construction as Fig. 1311

Height is adjustable from a minimum of 6 inches to a  
 maximum of 52 inches.

Each	Diameter Lower Tubing Inches	Weight Pounds
	3/4	1-1/2



→ See Sections L and M for New "CHROMALEX"® III Pole Lights

THE IMPROVEMENT FOR ABOVE LIGHTS IS A POSITIVE AND  
 UNIQUE TIGHTENING DEVICE FOR ADJUSTING THE HEIGHT  
 OR REMOVING THE POLE FROM THE BASE.  
 BASE DIMENSIONS — 31/4" LONG, 1 5/8" WIDE.



Fig. 1311

CERTIFIED

IMPROVED



Fig. 1311-SP

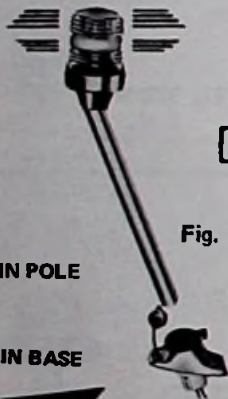

Fig. 1330

CERTIFIED



IN POLE



IN BASE

IMPROVED



Fig. 1330-SP

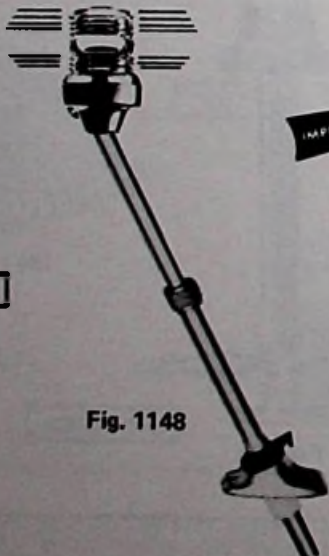

Fig. 1148

CERTIFIED

IMPROVED



## STOW – A – WAY TYPE—Fig. 1209

BRASS – CHROMIUM PLATED

Same Features as Fig. 1330 But this Unit has Bronze Globe Holder and Brass Mounting Base.

A Brass Cap is Attached to the Base to Waterproof the Opening When Pole is Removed. A Plastic Cap Retainer is Also Included.

Base, Length 3-3/8", Width 2-1/4".

Size No.	Each	Length Overall Inches	Weight Pounds
2		24	1
3		30	1-1/4
4		36	1-1/2



## POLE LIGHTS FOR WINDSHIELD MOUNTING 360 DEGREE CLEAR LIGHT – FOLD DOWN TYPE

VARIABLE ANGLE ASSEMBLY—Figs. 1134, & 1137

Die Cast Zinc Alloy Base and Globe Holder  
Chromium Plated

This light can be adjusted to suit any probable angle of windshield or top. Bracket is serrated to hold desired angle. Electric socket is our Delrin Non-Corrosive type.

High intensity Fresnel Globe at proper angle for horizontal beams of light.

Certified with a No. 90, 12 Volt 6 C.P. bulb we supply with the light.

32 Point – 2 Mile Visibility

Each	Height Overall Inches	Diameter Tubing Inches	Weight Ounces
	13-1/2	3/4	13

Fig. 1134 for flat Windshield or Horizontal Frame.

Dimensions, Width (A) - 2", Height (B) - 5/8".

Spare Brackets, Specify Fig. 1120

Fig. 1137 for flat or V-type Center Posts of Windshield.

Dimensions, Width (A) - 5/8", Height (B) - 2-1/4".

Spare Brackets, Specify Fig. 1122

Spare Brackets Include Thumb Screw, Washer and End Cap

Spare Thumb Screw Only Specify Fig. 1144



## GLARE SHIELDS – FIG. 663

For Pole or Mast Lights

18-8 Stainless Steel – with Vinyl Edge Moulding

Each	Dimensions Inches	Weight Ounces
	4-3/4 x 3-1/2	1-1/2



## HALYARD EYES—Figs. 234 & 235

For Metal Flag Poles – White Nylon

For quick attachment of flag. Fits 3/4 inch diameter poles.

Fig. 234, each.  
Fig. 235, each.

Standard Package, 10 Pieces.

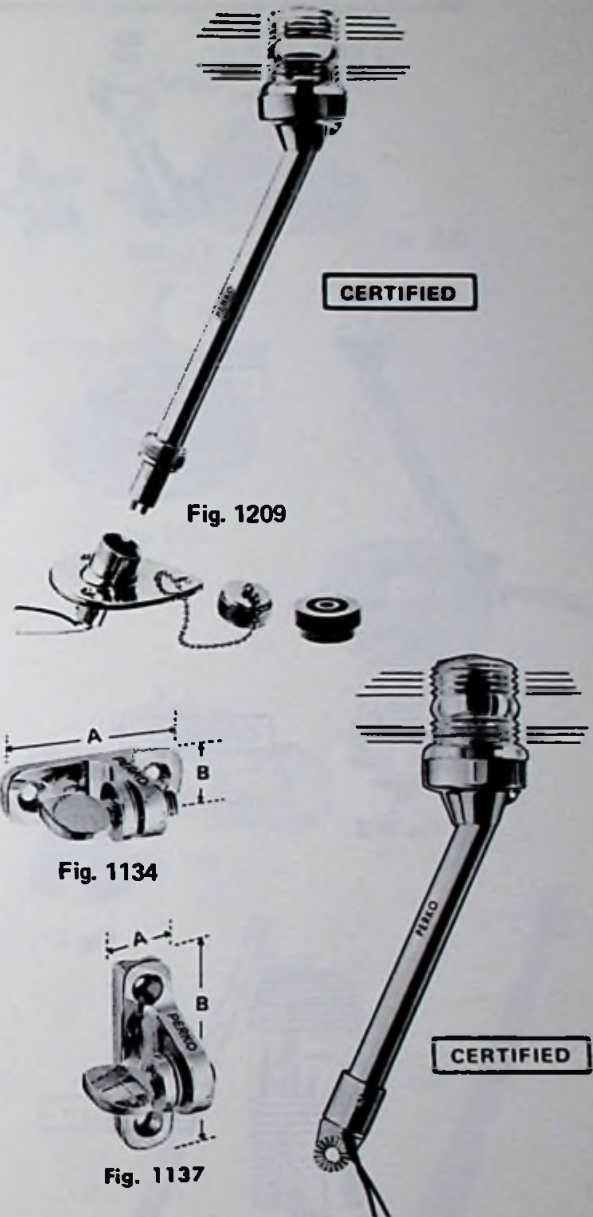

## SPARE PARTS FOR POLE LIGHTS PAGES A-6 AND A-7

Fresnel Globes with Gasket — See Fig. 248.

Delrin D.C. Sockets — See Fig. 24 No. 2.

Lamps (Bulbs) — See Fig. 337 No. 11.

Mounting Base Only For Figs. 1148, and 1311. Specify Fig. 1156.

Mounting Base Only For Fig. 1330 with Connector and Cap. Specify Fig. 1330-99-A.

Mounting Base Only For Fig. 1209 with Connector and Cap. Specify Fig. 1209-99-A.

Cap and Chain with Retainer For Fig. 1209, Specify Fig. 1209-99-B.

**CERTIFIED**



Fig. 455

**STERN OR ANCHOR LIGHT—Fig. 455**

Die Cast Zinc Alloy – Chromium Plated  
 Certified with No. 90 - 12 Volt, 6 C.P. Bulb Supplied.  
 2 Mile Visibility.

No.	Each	Height Inches	Diameter Globe Inches	Size Base Inches	Weight Ounces
1		6	1-3/4	3x2-1/8	12
2		12	1-3/4	3x2-1/8	16



**STERN OR ANCHOR LIGHT—Fig. 438**

All Brass – Chromium Plated  
 Certified with No. 90, 12 Volt 6 C.P. Bulb Supplied

2 Mile Visibility.

No.	Each	Height Inches	Diameter Globe Inches	Size Base Inches	Weight Ounces
1		6	1-3/4	3-3/8x2-1/4	6
2		12	1-3/4	3-3/8x2-1/4	10



Fig. 438

**CERTIFIED**

**MAST LIGHTS—Figs. 362 & 371**

Pressure Cast Bronze – Fresnel Globe – Double Contact Socket

Clear – Certified for No. 90, 12 Volt 6 C.P. Bulb

2 Mile Visibility.

Fig. 362 – Tapped for 1/2 inch pipe.

Fig. 371 – Flat base drilled for two flat head screws.

Bulb Not Included.



Fig. 362



Fig. 371

**CERTIFIED**

Fig.	Plain Each	Chromium Plated Each	Diam. Globe Inches	Height Overall Inches	Diam. Base Inches	Wt. Lbs.
362			1-3/4	3-1/4	2-1/8	1/2
371			1-3/4	2-7/8	2-1/8	3/8



**MAST LIGHTS—Fig. 488**

Cast Bronze – Plain – Clear Fresnel Globe –  
 Double Contact Socket – Bulb Not Included.  
 Certified For No. 1142, 12 Volt 21 C.P. Bulb

2 Mile Visibility.

Each	Height Overall Inches	Diam. Base Inches	Size Globe Inches	Opening in Globe Inches	Tapped Pipe Size Inches	Wt. Lbs.
	6	2-5/8	5-1/2x2-5/8	1-7/8	1/2	1



**ANCHOR OR SIGNAL LIGHT – Figs. 112 & 309**

Cast Bronze – Plain or Chromium Plated

High Intensity Fresnel Globe

Medium Screw Electric Socket – Bulb Not Included

Clear and Yellow – Certified for 15 Watt A-17 Bulb.

Red and Green – Certified for 25 Watt A-19 Bulb.

2 Mile Visibility

Fig.	Plain Each	Chromium Plated Each	Height Overall Inches	Diameter Base Inches	Tapped Pipe Size Inches	Weight Pounds
112			8-3/4	3-1/8	—	3 3/4
309			6 1/2	—	1/2	2 1/2

Yellow, Specify Fig. 112 M - Fig. 309 M

Red, Specify Fig. 112 R - Fig. 309 R

Green, Specify Fig. 112 G - Fig. 309 G



Fig. 112

**CERTIFIED**



Fig. 309

**CERTIFIED**

**SPARE PARTS**

Globes For Figs. 362, 371, 438, 455, See Fig. 248.

Globes For Fig. 488, See Fig. 77.

Globes For Figs. 112, 309, See Fig. 106.

D.C. Bulbs, See Fig. 337.

Medium Base Bulbs, See Fig. 340.

Sockets For Figs. 362, 371, See Fig. 24 No. 1.

Sockets For Figs. 438 and 455 See Fig. 24 No. 2

Socket For Fig. 488, See Fig. 278, No. 2

Sockets For Figs. 112, 309, See Fig. 222.

## ADJUSTABLE SPREADER FLOODLIGHT – Fig. 280

All Brass – Chromium Plated

12 Volt Sealed Beam Unit - Watertight

This light has a ball joint action allowing it to be rotated in any position

Each	Diameter Overall Inches	Depth Inches	Size Mounting Plate Inches	Weight Pounds
	4-5/8	2-1/2	5-3/8 x 3/4	1-1/4



Fig. 280

## SPREADER FLOODLIGHT—Fig. 268

All Brass – Chromium Plated – Sealed Beam – 12 Volts

A fully watertight unit for flood-lighting decks, anchorages, docks or sails.

Each	Diameter Overall Inches	Depth Inches	Size Mounting Plate Inches	Weight Pounds
	4-5/8	2-1/2	5-5/8 x 3/4	1-1/4



Fig. 268

## “NON-FOULING” SPREADER LIGHT—Fig. 265

Pressure Cast Bronze – Chromium Plated - With 12 Volt, 6 C.P. Bulb

For mounting flush to spreader, will not foul sheets or halyards. Has many other uses aboard the boat.

Each	Diameter Overall Inches	Depth Inches	Weight Ounces
	2-3/4	1-3/8	3-1/2



Fig. 265

## MEAL AND ABSENT LIGHT—Fig. 329

Cast Bronze – Watertight – Double Contact Bayonet Socket

For mounting on yardarm. Supplied with two fresnel globes, one blue, the other clear. Bulbs Not Included.

Chromium Plated Each	Size Base Inches	Length Overall Inches	Diam. Globe Inches	Wt. Lbs.
	3-3/8 x 1-3/4	9	2-1/2	2



Fig. 329

## WOOD FLAG STAFF—Fig. 496

Solid Mahogany – Varnished – With Ferrule

No.	Each	Length Overall Inches	Diam. Base Inches	Weight Ounces
2		14	3/4	2-1/2
3		18	3/4	3-1/2
4		18	1	5
5		24	1	6
6		30	1-1/4	9-1/2
7		36	1-1/4	14
8		48	1-1/4	27

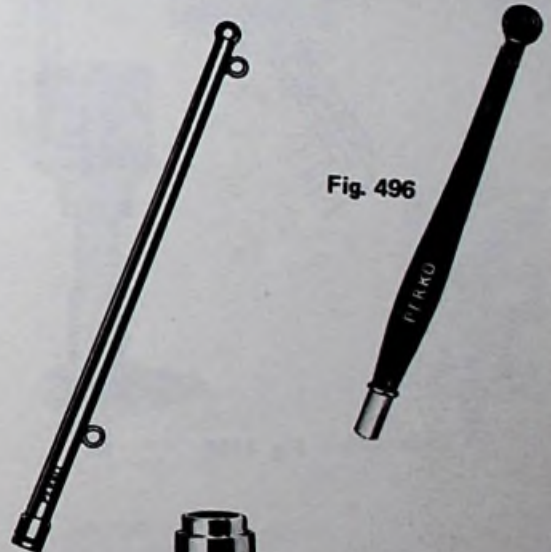

Fig. 496

## FLAG STAFF—Fig. 495 Chromium Plated

With eyes for flag halyard. Complete with rubber “O” ring for firm fit in socket.

No.	Each	Length Inches	Diam. Base Inches	Weight Ounces
1		14	1/2	3
2		14	3/4	4
3		18	3/4	5

Standard package, 5 Pieces.

Fig. 495

## CLAMP-ON FLAG STAFF SOCKET – Fig. 1302

Die Cast Zinc Alloy – Chromium Plated

Clamp will fit rails from 1/2” to 7/8” Diameter. Socket is 3/4” I.D. and will accommodate above staffs Figs. 495 and 496 Size Nos. 2 and 3.

Each	Dimensions Inches	Knob Inches	Weight Ounces
	2 x 1-3/4	1-3/4	11



Fig. 1302

SPARE KNOBS, SPECIFY FIG. 1292

## SPARE PARTS

Globes For Fig. 329, Specify Fig. 250 and Color.  
 Lens with Gasket For Fig. 265, Specify Fig. 264.  
 Sealed Beam Unit For Figs. 268 and Fig. 280, Specify Fig. 432. Lamps (Bulbs), For Fig. 265, See Fig. 70 No. 0.

Sockets For Fig. 329, See Fig. 24 No. 2.  
 Sockets For Fig. 265, Specify Fig. 265-99-A.  
 Lamps (Bulbs), For Fig. 329, See Fig. 337.



**COMBINATION BOW**

Here's a dual purpose fitting designed with a compartmented globe section each of which contains a bulb. When the forward compartment is illuminated, the light serves as a bow light which meets the requirements for a 20 point light (3 mile visibility) mounted at least 3' above the colored side or combination light. When both compartments are illuminated, it serves as a 32 point anchor light (2 mile visibility) visible all round the horizon.

All lights below certified with No. 1416 bulbs, 12 Volt, 8 C.P.



**FOLD DOWN ASSEMBLY—Fig. 1195**

For Windshield Mounting — Chromium Plated  
Stainless Steel Mounting Bracket

Complete with 2 Bulbs

Each	Length Overall Inches	Mounting Bracket Inches	Diameter Tubing Inches	Weight Pounds
	20	1-11/16 x 3	3/4	7/8

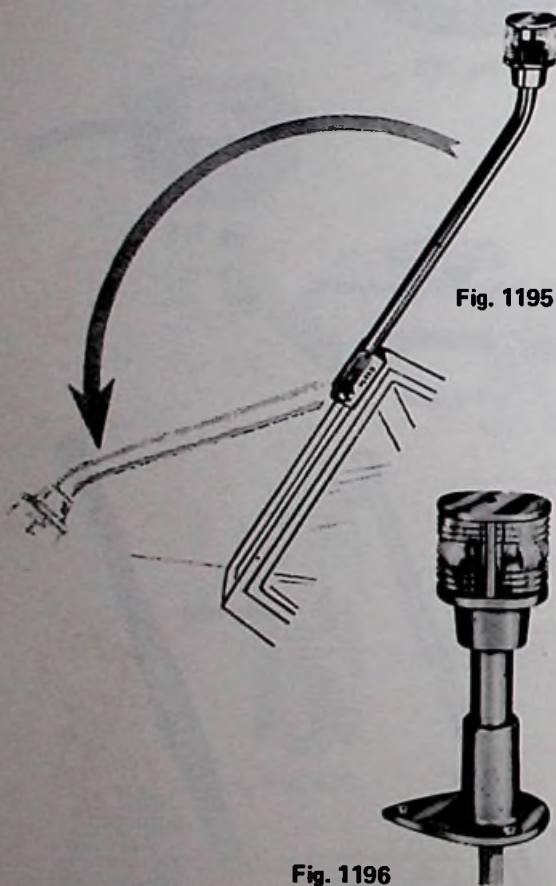

Fig. 1195

Fig. 1196

Glare Shield for above, see Fig. 1192.

Spare Mounting Bracket with Bolt and Nut, Specify Fig. 1157.



**FIXED ASSEMBLY—Fig. 1196**

For Hard Top Mounting — Chromium Plated  
Complete with 2 Bulbs.

No.	Each	Height Overall Inches	Size Base Inches	Weight Pounds
1		6	3 x 2	3/4
2		12	3 x 2	1

LENGTHS OTHER THAN ABOVE, SUPPLIED TO ORDER ONLY, PRICE AND DELIVERY ON APPLICATION, IN MANUFACTURING QUANTITY.



**GLARE SHIELD — Fig. 1192**

For Combination Bow and Anchor Lights — 18-8 Stainless Steel  
With Soft Vinyl Moulding Around Edges.

Supplied with 2 stainless steel self tapping screws. Bottom of light is pre-drilled for easy installation of shield.

Each	Dimensions Inches	Weight Ounces
	4-3/4 x 3-1/2	1-1/2

NOTE—This shield cannot be supplied with Figs. 1183, 1195 and 1196.



Fig. 1192

## AND ANCHOR LIGHTS

This unit saves time and money for builders and do-it-yourself owners. The light is completely wired and color coded for three position switch. See Switch Fig. 366.

This combination bow and anchor light feature can be supplied immediately in the products appearing below. Other assemblies to meet specific requirements can be made to order. All Electric Sockets are Brass.

All lights below certified with No. 1416 bulbs, 12 Volt, 8 C.P.

Patent No. 3344264



### FOLD DOWN

#### VARIABLE ANGLE ASSEMBLY – Figs. 1181, 1182 & 1184

For Windshield Mounting – Chromium Plated  
Complete with Two Bulbs

This light can be adjusted to suit any probable angle of windshield or top. Bracket is serrated to hold desired angle.

Complete Each	Height Overall Inches	Diameter Tubing Inches	Weight Ounces
	13-1/2	3/4	13

Fig. 1181 for flat windshield or horizontal frame, dimensions, Width (A), 2" – Height (B), 5/8".

Spare Brackets, Specify Fig. 1120

Fig. 1182 for V-type windshield, dimensions, Width (A), 2" – Height (B), 5/8".

Spare Brackets, Specify Fig. 1121

Fig. 1184 for flat or V-type center posts of windshield, dimensions, Width (A), 5/8" – Height (B), 2-1/4".

Spare Brackets, Specify Fig. 1122

Spare Brackets include Thumb Screw, Washer and End Cap.

Spare Thumb Screw Only Specify Fig. 1144.



### MAST ASSEMBLY – Fig. 1183

With Round Flange Mounting Base – Chromium Plated  
Complete with Two Bulbs

Each	Height Inches	Diameter Base Inches	Weight Ounces
	2-3/4	1-15/16	8



### MAST ASSEMBLY – Fig. 1197

For Mounting Into Masthead or Over a Staff

Chromium Plated –

Complete with Two Bulbs

Each	Height Overall Inches	O.D. Tubing Inches	Length Tubing Inches	Weight Ounces
	3-1/2	3/4	1	6

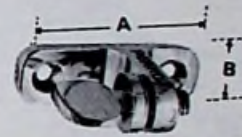
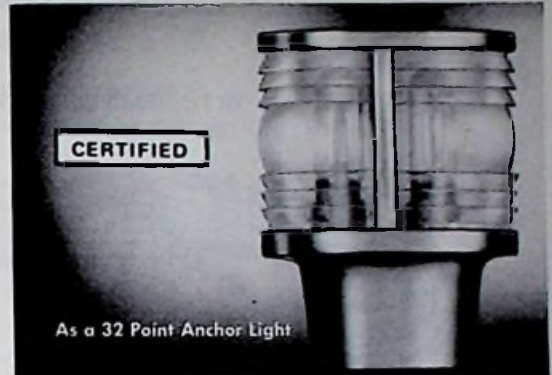

Fig. 1181

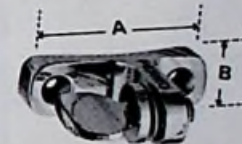

Fig. 1182



Fig. 1184



Fig. 1183



Fig. 1197

### SPARE PARTS

Spare Lenses Specify Fig. 278.

Spare Electric Sockets, Miniature Bayonet, Specify Fig. 1109.

Three Position Switches, See Fig. 366.

Spare Lamps (Bulbs), See Fig. 56 No. 4.

Spare Lens Cap with Screw, Specify Fig. 1158.

® "CHROMALEX" INTERNATIONAL NAVIGATION LIGHTS  
 BRASS — PERKOPLATE CHROMIUM PLATED  
 BLACK PLASTIC BASE  
 WITH STAINLESS STEEL SELF TAPPING SCREWS FOR MOUNTING



CERTIFIED

Fig 955

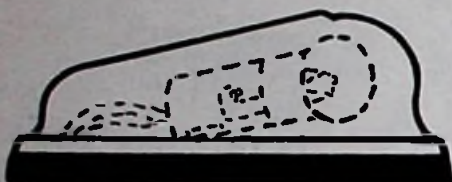

END VIEW OF REAR AND OUTLINE OF SOCKET INSTALLATION. DRILL SMALL HOLE FOR WIRE ONLY.

Fig. 955-SP

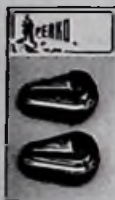

CERTIFIED



Fig. 915

CERTIFIED



Fig. 903

**SIDE LIGHTS—Fig. 955**

10 Points — 112-1/2 Degrees — 1 Mile Visibility  
 Certified with No. 90, 12 Volt, 6 C.P. Bulb Supplied with Lights  
 Delrin Non Corrosive Double Contact Socket  
 Red and Green High Intensity Fresnel Lenses

Per Pair	Length Inches	Width Inches	Depth Inches	Weight Per Pair Ounces
	4-1/4	2-3/8	1-3/4	7

Half Pair, Red, Specify Fig. 955 R, Green, Specify Fig. 955 G  
 Spare Lenses, Red, Specify Fig. 283 R  
 Spare Lenses, Green, Specify Fig. 283 G  
 Spare Sockets, see Fig. 24 No. 1  
 Spare Lamps (Bulbs) see Fig. 337 No.11



**SKIN PACK — Fig. 955-SP**

1 Pair Per Card  
 4 Cards Per Box  
 Weight Per Box, 2 Pounds  
 Sold To Trade In Full Box Only



**SIDE LIGHTS- Fig. 915**

10 Points — 112-1/2 Degrees — Red and Green Lenses  
 1 Mile Visibility  
 Certified with No. 1416, 12 Volt, 8 C.P. Bulb Supplied with Light — Brass Miniature Bayonet Type Socket  
 For Mounting on Deck or Top of Deck House

Per Pair	Length Inches	Width Inches	Depth Inches	Weight Per Pair Ounces
	4-1/4	2-3/8	1-3/4	7

Half Pair, Red, Specify Fig. 915 R, Green, Specify Fig. 915 G.  
 Spare Lenses, Red, Specify Fig. 281 R  
 Spare Lenses, Green, Specify Fig. 281 G  
 Spare Sockets, Specify Fig. 1109  
 Spare Lamps (Bulbs), see Fig. 56 No. 4



**BOW LIGHTS — Fig. 903**

20 Points — 225 Degrees — Clear Lens  
 3 Mile Visibility  
 Certified with No. 1416, 12 Volt, 8 C.P. Bulb Supplied with Light — Brass Miniature Bayonet Type Socket

Each	Length Inches	Width Inches	Depth Inches	Weight Ounces
	4-1/4	2-3/8	1-3/4	4

Spare Lenses, Specify Fig. 281 - Clear  
 Spare Sockets, Specify Fig. 1109  
 Spare Lamps (Bulbs), see Fig. 56 No. 4

## ® "CHROMALEX" INTERNATIONAL NAVIGATION LIGHTS

BRASS — PERKOPLATE CHROMIUM PLATED  
BLACK PLASTIC BASE  
WITH STAINLESS STEEL SELF TAPPING SCREWS FOR MOUNTING

Certified With No. 1416, 12 Volt, 8 C.P. Bulb Supplied With Light — Brass Miniature Bayonet Type Socket

Height Light Inches	Diameter Base Inches	Diameter Neck Inches	Length Neck Inches	Weight Each Ounces
1-5/8	2-3/8	3/4	1/2	3

### SIDE LIGHTS—Fig. 963

10 Points — 112-1/2 Degrees — Red and Green Lenses  
1 Mile Visibility

For mounting on deck or top of deck house.

Per Pair

Half Pair, Red, Specify Fig. 963-R. Green, Specify Fig. 963-G.  
Spare Lenses, Red, Specify Fig. 281-R.  
Spare Lenses, Green, Specify Fig. 281-G.  
Spare Sockets, Specify Fig. 1109.



CERTIFIED

Fig. 963

---

### BOW LIGHTS — Fig. 964

20 Points — 225 Degrees — Clear Lens  
3 Mile Visibility.

Each

Spare Lenses, Specify Fig. 281 - Clear.  
Spare Sockets, Specify Fig. 1109.

CERTIFIED



Fig. 964

---

### SKIN PACK — Fig. 964-SP

One Light Per Card  
Four Cards Per Box  
Weight Per Box, 1 Pound

Sold To Trade In Full Box Only



Fig. 964-SP

---

### STERN LIGHT — Fig. 965

12 Points — 135 Degrees — Clear Lens  
2 Mile Visibility

Each

Spare Lenses, Specify Fig. 281, Clear.  
Spare Sockets, Specify Fig. 1109

CERTIFIED



Fig. 965

---

### SKIN PACK — Fig. 965-SP

One Light Per Card  
Four Cards Per Box  
Weight Per Box, 1 Pound

Sold To Trade In Full Box Only

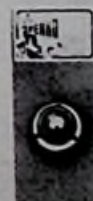

Fig. 965-SP



CERTIFIED

Fig. 1264

**"NAUTIC" STREAMLINE SIDE LIGHTS – Fig. 1264**

Die Cast Zinc Alloy – Polished Chromium Plated  
 Delrin Non-Corrosive Double Contact Socket  
 High Intensity Fresnel Lenses  
 10 Points – 112 1/2 Degrees – 1 Mile Visibility  
 Colored Lenses 1 Red and 1 Green

Certified With No. 1004, 12 Volt, 15 C.P. Bulb Supplied With Light

Per Pair	Length Overall Inches	Height Overall Inches	Thickness Inches	Weight Per Pair Pounds
	5-1/2	3-1/8	1-3/4	1-3/4

Half Pair, Red, Specify Fig. 1264 R. Green, Specify Fig. 1264 G

Spare Lenses, Red, Specify Fig. 1264-99R

Spare Lenses, Green Specify Fig. 1264-99G

Spare Sockets, Specify Fig. 24, No.1

Spare Lamps (Bulbs) see Fig. 337 No.12



CERTIFIED

Fig. 1265

**"NAUTIC" STREAMLINE BOW LIGHTS – Fig. 1265**

Die Cast Zinc Alloy – Polished Chromium Plated  
 Delrin Non-Corrosive Double Contact Socket  
 High Intensity Fresnel Lens.

20 Points – 225 Degrees – 3 Mile Visibility – Clear Lens

Certified With No. 1004, 12 Volt, 15 C.P. Bulb Supplied With Light

Each	Length Overall Inches	Width Overall Inches	Height Overall Inches	Weight Pounds
	6-1/4	3-7/8	3-1/4	3/4

Spare Lenses, Specify Fig. 1265-99 A

Spare Sockets, Specify Fig. 24, No. 1

Spare Lamps (Bulbs), see Fig. 337 No. 12



Fig. 1178

**BOW OR MASTHEAD LIGHT – Fig. 1178**

Die Cast Zinc Alloy – Polished Chromium Plated  
 Fresnel Lens – Brass Miniature Bayonet Socket  
 20 Points – 225 Degrees – 3 Mile Visibility

Certified with No. 1416, 12 Volt, 8 C.P. Bulb Supplied with Light

Each	Height Inches	Diameter Base Inches	Weight Ounces
	2-3/4	1-3/4	8

Spare Lens, Specify Fig. 278

Spare Sockets, Specify Fig. 1109

Spare Lamps (Bulbs), see Fig. 56 No. 4



CERTIFIED

Fig. 1331

**®CHROMALEX BOW LIGHT – Fig. 1331**

Die Cast Zinc Alloy – Polished Chromium Plated  
 Black Plastic Base  
 High Intensity Clear Fresnel Lenses

Brass Miniature Bayonet Socket  
 20 Points – 225 Degrees – 3 Miles Visibility

Certified with No. 1416, 12 Volt, 8 C.P. Bulb Supplied with Light

Each	Height Overall Inches	Width Overall Inches	Size Screw No.	Weight Ounces
	3-3/4	1-1/2	5	4

Spare Lens, Specify Fig. 278,

Spare Socket, Specify Fig. 1109

Spare Lamps (Bulbs), see Fig. 56 No. 4



## ®CHROMALEX STERN LIGHTS – Fig. 1332

Die Cast Zinc Alloy – Polished Chromium Plated  
Black Plastic Base  
High Intensity Clear Fresnel Lenses

Certified with No. 1416, 12 Volt 8 C.P. Bulb,  
Supplied with Light, Brass Miniature Bayonet Type Socket  
12 Points – 135 Degrees – 2 Mile Visibility

Each	Height Overall Inches	Width Overall Inches	Size Screw No.	Weight Ounces
	3-3/4	1-1/2	5	4

Spare Lens, Specify Fig. 278  
Spare Socket, Specify Fig. 1109  
Spare Lamps (Bulbs) see Fig. 56 No. 4



Fig. 1332

CERTIFIED

## ®CHROMALEX TRANSOM STERN LIGHT – Fig. 945

Brass – Polished Chromium Plated  
Black Plastic Base  
With Stainless Steel Screws For Mounting  
12 Points – 135 Degrees – Clear Lens  
2 Mile Visibility

Certified with No. 1416, 12 Volt, 8 C.P. Bulb Supplied  
with Light. Brass Miniature Bayonet Type Socket

Each	Height of Light Inches	Diameter of Base Inches	Diameter of Neck Inches	Length Neck Inches	Weight Ounces
	1-5/8	2 3/8	3/4	1/2	3

Spare Lenses, Specify Fig. 74  
Spare Sockets, Specify Fig. 1109  
Spare Lamps (Bulbs) see Fig. 56 No. 4



Fig. 945

CERTIFIED

## SKIN PACK – Fig. 945-SP

One Light Per Card  
Four Cards Per Box  
Weight Per Box, 1 Pound

Sold To Trade In Full Box Only



Fig. 945-SP

## TRANSOM STERN LIGHTS – Figs. 939 and 946

Brass – Polished Chromium Plated  
12 Points – 135 Degrees – Clear – 2 Mile Visibility  
Supplied Complete with 12 Volt Bulb

Certified for 12 Volt with No. 211-2, 12 Volt, 12 C.P. Bulb  
Certified for 32 Volt with No. 10126, 32 Volt, 12 C.P. Bulb

Fig. 939

Complete with Neoprene Installation gasket

Each	Dimensions		Weight Ounces
	Overall Inches	Depth Inches	
	5-3/16 x 3-3/8	1-1/2	6

Fig. 946

Supplied Complete with Black Plastic Base  
and Stainless Screws for Mounting

Each	Diameter Inches	Depth Inches	Weight Ounces
	3	1-3/4	4

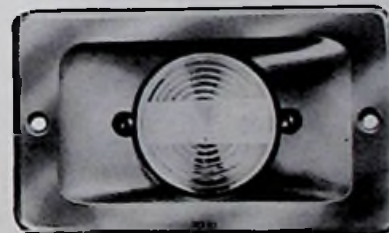

Fig. 939 – Flush Type

CERTIFIED

CERTIFIED

Fig. 946  
Semi Flush Type



## SPARE PARTS

Lens with Gasket For Fig. 939, Specify Fig. 284.  
Lens with Gasket For Fig. 946, Specify Fig. 946-99-A.  
Socket Assembly For Fig. 939, Specify Fig. 939-99-B

Socket Assembly For Fig. 946, Specify Fig. 946-99B.  
Installation Gasket For Fig. 939, Specify Fig. 939-99C.  
Lamps (Bulbs) See Fig. 70 Nos. 1 and 2

**"ROYAL" INTERNATIONAL NAVIGATIONAL LIGHTS**

**SHEET METAL – GALVANIZED STEEL OR BRASS**

**BAYONET DOUBLE CONTACT ELECTRICAL SOCKET – FRESNEL LENSES**

Figs. 91 and 99 Certified For Use With No. 1004, 12 Volt, 15 C.P. Bulb  
 Fig. 98 Certified For Use With No. 1144, 12 Volt, 32 C.P. Bulb. Bulb Not Included.



Fig. 91

**CERTIFIED**



Fig. 98



Fig. 99

**SIDE LIGHTS – Fig. 91**

**10 Points – 112-1/2 Degrees – 1 Mile Visibility**  
**Colored Lenses 1 Red and 1 Green**

Class	Galv. Per Pair	Polished Brass Per Pair	Height Inches	Height Lens Inches	Weight Per Pair Pounds
2			5	4-1/4	2
3			6	5-3/16	3

Half Pair, Red, Specify Fig. 91-R. Green Specify Fig. 91-G.

**BOW OR MASTHEAD LIGHTS—Fig. 98**

**20 Points – 225 Degrees – Clear Lens – 3 Mile Visibility**

**STERN LIGHTS—Fig. 99**

**12 Points – 135 Degrees – Clear Lens – 2 Mile Visibility**

Class	Galv. Each	Polished Brass Each	Height Inches	Height Lens Inches	Weight Pounds
2			5	4-1/4	1-1/2
3			6	5-3/16	2

**"CORONET" INTERNATIONAL NAVIGATION LIGHTS**

**DIE CAST ZINC ALLOY – SATIN CHROMIUM PLATED**

**HIGH INTENSITY FRESNEL LENSES – FUSE TYPE ELECTRIC SOCKETS**

Certified for 12 Volt with No. 211-2, 12 Volt, 12 C.P. Bulb

Certified for 32 Volt with No. 10126, 32 Volt, 12 C.P. Bulb

**BULBS NOT INCLUDED**

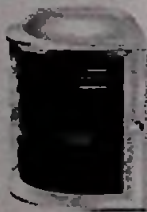
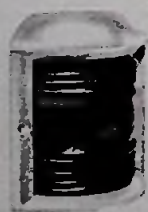

Fig. 109



**CERTIFIED**



Fig. 110



Fig. 111

**SIDE LIGHTS – Fig. 109**

**10 Points – 112-1/2 Degrees – 2 Mile Visibility**  
**Colored Lenses 1 Red and 1 Green**

Class	Per Pair	Height Light Inches	Height Lens Inches	Weight Per Pair Pounds
2		5-1/4	4-1/4	2

Half Pair, Red, Specify Fig. 109-R. Green, Specify Fig. 109-G.

**BOW OR MASTHEAD LIGHTS – Fig. 110**

**20 Points – 225 Degrees – Clear Lens – 3 Mile Visibility**

**STERN LIGHTS – Fig. 111**

**12 Points – 135 Degrees – Clear or Yellow Lens\***  
**2 Mile Visibility**

Class	Each	Height Light Inches	Height Lens Inches	Weight Pounds
2		5-1/4	4-1/4	1

\*With Yellow Lens, Specify Fig. 111M.

**SPARE PARTS**

Lenses For Figs. 91 and 109, See Fig. 259.  
 Lenses For Figs. 98 and 110, See Fig. 259.  
 Lenses For Figs. 99 and 111, See Fig. 259.  
 Electric Adapters For Figs. 91, 98, 99, See Fig. 138, Specify Class.

Lamps (Bulbs) For Fig. 98, See Fig. 337 No. 14.  
 Lamps (Bulbs) For Figs. 91 and 99, See Fig. 337 No. 12.  
 Lamps (Bulbs) For Figs. 109, 110, 111, See Fig. 70 Nos. 1 and 2.  
 Mounting Bracket For Figs. 91, 98, 99, Specify Fig. 92 and Finish.  
 D.C. Sockets For Figs. 91, 98, 99, See Fig. 24 No. 1.

## ELECTRIC NAVIGATION LIGHTS SHEET METAL – GALVANIZED STEEL OR BRASS

ELECTRIC SOCKET IS BAYONET DOUBLE CONTACT OR MEDIUM SCREW TYPE

BRASS SPRING TYPE ADAPTERS – BULBS NOT INCLUDED

### SIDE LIGHTS—Fig. 4

10 Points – 112-1/2 Degrees – Red and Green  
Fresnel Lenses – 1 Mile Visibility

Class	Galvanized Per Pair	Polished Brass Per Pair	Height Inches	Height Lens Inches	Weight Per Pair Pounds
2			7-1/4	4-1/4	5
3			8-1/2	5-3/16	7

Half Pairs, Red, Add "R", Green, Add "G" to Fig. No. Specified

Double Contact Electric—Specify Fig. 4-A. Certified for No. 1004 Bulb, 12 Volt, 15 C.P.

Medium Screw Electric—Specify Fig. 4-B. Certified for 15 Watt, A-17 Bulb.

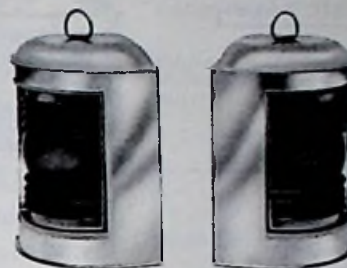

Fig. 4

CERTIFIED

### BOW LIGHTS—Fig. 5

20 Points – 225 Degrees – Clear Or Yellow Fresnel Lens  
Clear – 3 Mile Visibility. \* Yellow – 2 Mile Visibility.

Class	Galvanized Each	Polished Brass Each	Height Inches	Height Lens Inches	Weight Pounds Each
2			7-1/4	4-1/4	2-1/2
3			8-1/2	5-3/16	3-1/4

Double Contact Electric – Specify Fig. 5-A. Certified for No. 1142 Bulb, 12 Volt, 21 C.P.

Medium Screw Electric—Specify Fig. 5-B. Certified for 25 Watt, A-19 Bulb.

\*Yellow – Class 3 Only, Double Contact Specify Fig. 5-MA.

Certified For No. 1004 Bulb, 12 Volt, 15 C.P.

Medium Screw, Specify Fig. 5-MB. Certified For 15 Watt, A-17 Bulb.



Fig. 5

CERTIFIED

### STERN LIGHTS – Fig. 7

12 Points – 135 Degrees – Clear Or Yellow Fresnel Lens\*  
2 Mile Visibility

Class	Galvanized Each	Polished Brass Each	Height Inches	Height Lens Inches	Weight Pounds Each
2			7-1/4	4-1/4	2-1/2
3			8-1/2	5-3/16	3-1/4

Double Contact Electric – Specify Fig. 7-A, Certified

For No. 1004 Bulb, 12 Volt, 15 C.P. Clear or Yellow

Medium Screw Electric – Specify Fig. 7-B, Certified

For 15 Watt A-17 Bulb, Clear or Yellow

\*Yellow – Class 3 Only, Double Contact, Specify

Fig. 7-MA. Medium Screw, Specify Fig. 7-MB



Fig. 7

CERTIFIED

NEW

### ANTI-COLLISION STROBE LIGHT – Fig. 600

Satin Chromium Plated Housing – Clear 360° Fresnel  
Globe – High Intensity Xenon Strobe Lamp – Watertight  
For 12 Volt Use

This Powerful New Unit with Built-in Polarity Protection  
PRODUCES OVER 1 MILLION (1,000,000) PEAK CANDLE-  
POWER FOR INCREASED DISTANCE OF VISIBILITY.  
Flashes approximately 60 Times a Minute. Mounting Bracket  
for Flat Surfaces is Easily Removed, Base of Light fits 1/2"  
Pipe.

Each	Height Overall Inches	Diameter Inches	Weight Pounds
	7	3-1/8	1



Fig. 600

NEW

### SPARE PARTS

Lenses For Fig. 4, See Fig. 259.  
Lenses For Fig. 5, See Fig. 256.  
Lenses For Fig. 7, See Fig. 269.  
Double Contact Adapters, See Fig. 291.  
Medium Screw Adapters, See Fig. 292.

Lamps (Bulbs), See Fig. 337, Nos. 12 and 13.  
Also Fig. 340, Nos. 5 and 6.  
D.C. Sockets Only – See Fig. 276.  
Medium Screw Sockets Only – See Fig. 348 No. 1.  
Side Light Brackets, See Fig. 131.

**CERTIFIED  
ELECTRIC ONLY**



Fig. 17 Class 2  
Fig. 19 Class 3



Fig. 18 Class 2  
Fig. 20 Class 3

**CERTIFIED  
ELECTRIC ONLY**



Fig. 97 Class 2  
Fig. 102 Class 3



Fig. 0-2 JUNIOR

**CERTIFIED  
ELECTRIC ONLY**



Fig. 0-6 SENIOR

### SIDE LIGHTS—Figs. 17 and 19

10 Points — 112-1/2 Degrees — Red and Green Fresnel Lenses

Fig.	Galvanized Per Pair	Polished Brass Per Pair	Height Inches	Height Lens Inches	Weight Pounds
17	Oil		10-1/2	4-1/4	5-1/2
19	Oil		12-1/2	5-3/16	7-1/2

Half Pairs — Red, Add "R", Green, Add "G" to Fig. No. Specified.

Double Contact Electric—Specify Fig. 17-A or 19-A. Certified for No. 1004 Bulb, 12 Volt, 15 C.P. 1 Mile Visibility.

Medium Screw Electric—Specify Fig. 17-B or 19-B. Certified for 15 Watt, A-17 Bulb, 1 Mile Visibility.

### BOW LIGHTS—Figs. 18 and 20

20 Points — 225 Degrees — Clear Fresnel Lens

Fig.	Galvanized Each	Polished Brass Each	Height Inches	Height Lens Inches	Weight Pounds
18	Oil		10-1/2	4-1/4	3
20	Oil		12-1/2	5-3/16	3-1/2

Double Contact Electric — Specify Fig. 18-A or 20-A. Certified for No. 1144 Bulb, 12 Volt, 32 C.P. 3 Mile Visibility.

Medium Screw Electric — Specify Fig. 18-B or 20-B. Certified for 25 Watt, A-19 Bulb. 3 Mile Visibility.

### STERN LIGHTS—Figs. 97 and 102

12 Points — 135 Degrees — Clear Fresnel Lens

Fig.	Galvanized Each	Polished Brass Each	Height Inches	Height Lens Inches	Weight Pounds
97	Oil		10-1/2	4-1/4	3
102	Oil		12-1/2	5-3/16	3-1/2

Double Contact Electric—Specify Fig. 97-A or 102-A. Certified for No. 1004 Bulb, 12 Volt, 15 C.P. 2 Mile Visibility.

Medium Screw Electric—Specify Fig. 97-B or 102-B. Certified for 15 Watt, A-17 Bulb. 2 Mile Visibility.

### ANCHOR LIGHTS — Figs. 02 and 06

32 Points — 360 Degrees — Clear Fresnel Lens — Oil or Electric — 2 Mile Visibility — Electric Only — Bulbs Not Included

Double Contact Electric, All Colors Listed Certified for No. 1004 Bulb, 12 Volt, 15 C.P. Specify Fig. 0-2A or 0-6A

Medium Screw Electric, Clear or Yellow, Certified for 15 Watt A-17 Bulb Specify Fig. 0-6B and Color

Medium Screw Electric, Red or Green, Certified for 25 Watt A-19 Bulb Specify Fig. 0-6B and Color

FOR NAVIGATIONAL PURPOSES WE DO NOT INSTALL A MEDIUM SCREW SOCKET IN Fig. 0-2

AVAILABLE AND CERTIFIED IN FOLLOWING TYPE SOCKETS AND COLORS FOR ELECTRIC ONLY

	CLEAR	RED	GREEN	YELLOW
0-2 D.C. SPECIFY	0-2A	0-2RA	0-2GA	0-2MA
0-6 D.C. SPECIFY	0-6A	0-6RA	0-6GA	0-6MA
0-6 Med.Screw SPECIFY	0-6B	0-6RB	0-6GB	0-6MB

#### FOR OIL USE ONLY

Fig. 0-2 Available in Clear Only.

Fig. 0-6 Available in Clear, Red, Green or Yellow, Specify Color.

Fig.	Galvanized Each	Polished Brass Each	Height Inches	Height Lens Inches	Weight Pounds
0-2			8-5/8	3-5/16	2
0-6			11-3/4	4-1/4	3

### SPARE PARTS

Lenses For Figs. 17 and 19, See Fig. 250.  
Lenses For Figs. 18 and 20, See Fig. 256.  
Lenses For Figs. 97 and 102, See Fig. 260.  
Lenses For Fig. 0-2, end 0-6, See Fig. 261.  
Oil Pounts For All Except Fig. 0-2, See Fig. 286.  
Oil Pounts For Fig. 0-2, See Fig. 287.  
Medium Screw Sockets Only, See Fig. 346 No. 1.

Electric Adaptors For All Except Fig. 0-2, See Figs. 291, 292.  
Electric Adaptors For Fig. 0-2, See Fig. 293.  
Burners and Wicks For All Above, See Figs. 246, 302.  
Lamps (Bulbs), See Fig. 337 Nos. 12 and 14 Also Fig. 340 Nos. 5 and 6.  
D.C. Sockets Only, See Fig. 276.  
Side Light Brackets, See Fig. 131.

## SPARE PARTS FOR SECTION A

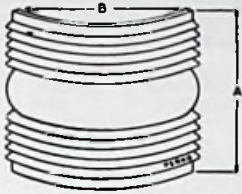

### 112<sup>1</sup>/<sub>2</sub>° LENSES

Class	Each	A Inches	B Inches
2		4-1/4	3-3/16
3		5-3/16	3-11/16

Red - Fig. 259-R  
Green - Fig. 259-G

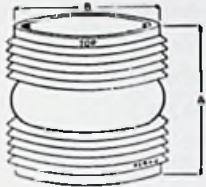

Fig. 77

### FRESNEL GLOBES Clear Glass

Complete with Gasket

Each	Height Inches	Diam. Thread Inches	Inside Diam. Inches
	5-1/2	2-3/8	1-7/8



### 360° LENSES

Class	Each	A Inches	B Inches
Junior		3-5/16	3-3/16
Senior		4-1/4	4

\* Clear - Fig. 261  
Red - Fig. 261-R  
Green - Fig. 261-G  
Yellow - Fig. 261-M

\*Specify if for use with Oil or Electric Light



Fig. 24

### BAYONET

Double Contact Sockets  
Delrin Body - Bronze Spring  
Non-Corrosive Positive Contact

No.	Each	Length Pigtails Inches	Outside Diameter Inches
1		6	3/4
2		60	3/4

Standard package, 10 pieces

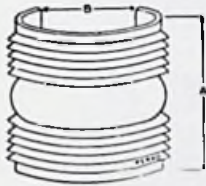

### 225° LENSES

Class	Each	A Inches	B Inches
2		4-1/4	3-3/8
3		5-1/8	3-1/4

Clear - Fig. 256  
Yellow - Fig. 256-M (Class 3 Only)



Fig. 52

### BAYONET

Double Contact Socket  
Brass Case - Bronze Spring

Each	Outside Diameter Inches	Length Inches	Length Pigtails Inches
	11/16	7/8	5

Standard package 10 pieces.

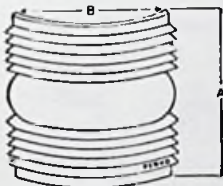

### 135° LENSES

Class	Each	A Inches	B Inches
2		4-1/4	3-1/2
3		5-1/8	3-5/8

Clear - Fig. 269  
Yellow - Fig. 269-M



Fig. 747

### BAYONET

Double Contact Socket  
Brass Case - Hard Rubber Insulation

Each	Length Inches	Outside Diameter Inches
	1-1/8	11/16

Wires enter bottom, screws in side.  
Standard package 10 pieces.



Fig. 248

### FRESNEL GLOBES Clear - Plastic Complete with Gasket

Each	Height Inches	Diameter Thread Inches
	2 1/4	2



### SKIN PACK - Fig. 248-SP Complete with Gasket

One Globe Per Card  
Ten Cards Per Box  
Weight Per Box, 1 1/2 Pounds  
Sold To Trade In Full Box Only



Fig. 276

### BAYONET

Double Contact Sockets  
Brass Case - Tapped 1/8 Inch I.P.S.

No.	Each	Length Overall Inches
0		1-1/2
2		2
3		2-3/8
4		3



Fig. 106

### FRESNEL GLOBES Plastic Complete with Gasket

Each	Height Inches	Diam. Thread Inches	Inside Diam. Inches
	5	3-1/4	2-7/8

Clear - Fig. 106  
Red - Fig. 106-R  
Green - Fig. 106-G  
Yellow - Fig. 106-M



Fig. 346

### MEDIUM SCREW SOCKETS

Phenolic - C.G. Approved

250 Volts - 660 Watts

No.	Each	Size Thread Inches	Height Inches	Extreme Diameter Inches
1		1/8	1-7/8	1-3/8
2		3/8	1-7/8	1-3/8

Standard package 5 pieces.

**SPARE PARTS FOR SECTION A**



Fig. 286

**OIL FOUNT**  
Brass - Spring Type

Each	Diameter Overall Inches	Opening In Light Inches
	3-5/8	3-3/16

Used in All Lights on Page A-18 Except Fig. 0-2. Also Used in Fig. 44-8" and Fig. 49.



Fig. 287

**OIL FOUNT**  
Brass - Swivel Type

Each	Diameter Overall Inches	Opening In Light Inches
	4-1/2	4

Used in Figs. 0-2 and 44, 6"



Fig. 291

**ELECTRIC ADAPTERS**  
Double Contact  
Brass - Spring Type

Each	Diameter Overall Inches	Opening In Light Inches
	3-5/8	3-3/16

Used in the Following Lights Size Figs.

No. 3 - 06, 4C/2, 5C/2, 7C/2, 17, 18, 97  
No. 4 - 4C/3, 5C/3, 7C/3, 19, 20, 102

Be Sure To Specify Size No.



Fig. 293

**ELECTRIC ADAPTER**  
Double Contact  
Brass - Swivel Type

Each	Diameter Overall Inches	Opening In Light Inches
	4-1/2	4

Used in Fig. 02



Fig. 292

**ELECTRIC ADAPTER**  
Medium Screw  
Brass - Spring Type

Each	Diameter Overall Inches	Opening In Light Inches
	3-5/8	3-3/16

Used in All Lights on Pages A-18 and A-19. Except Fig. 02. Also Used in Fig. 44-8" and Fig. 49.



Fig. 274

**ELECTRIC ADAPTER**  
Medium Screw  
Brass - Swivel Type

Each	Diameter Overall Inches	Opening In Light Inches
	4-1/2	4

Used in Figs. 0-2 and 44, 6"



Fig. 246

**OIL BURNERS**  
Brass

Each	Diam. Thread Inches	Width Wick Inches
	7/8	1/2

Standard Package, 10 Pieces

Used in All Lights on Page A-18, Also Fig. 44, 6" and 8", Fig. 49



Fig. 138

**ELECTRIC ADAPTER**  
Double Contact  
Brass - Swivel Type

Each	Diam. Overall Inches	Opening In Light Inches
	2-3/16	1-7/8

Used in Figs. 91, 98 and 99. Specify Class 2 or 3.



Fig. 302

**FLAT OIL WICKS**  
Cotton

No. 0	Each	Width Inches
		1/2

Standard Package, 10 Pieces



Fig. 131

**MOUNTING BRACKETS**  
For Lights  
Galvanized or Brass

Galv. Each	Brass Each	Width Inches	Height Inches
		1-1/2	4-3/4

Used on All Lights on Page A-18 and A-19 Except Figs. 02 and 06.

# SECTION B

# PERKO<sup>®</sup>

**navigation lights  
for vessels over  
20 meters (65.7 ft.)**



MANUFACTURED BY PERKO, INC., 16490 N.W. 13TH AVE., P.O. BOX 64000-D, MIAMI, FLORIDA 33164

FOR COMPLETE LINE SEE CATALOG NO. 230

© PERKO, INC.  
ALL RIGHTS RESERVED

PORTIONS OF THIS CATALOG PREVIOUSLY  
COPYRIGHTED IN 1936 THRU 1976 INCLUSIVE

### IMPORTANT INFORMATION

On March 31, 1977, the U.S. Coast Guard published in the Federal Register, an amendment to the navigation and navigable waters regulations, which added a new subchapter DD, (33CFR 87). This subchapter contains rules implementing and interpreting the International Regulations for Preventing Collisions at Sea, 1972 (72 COLREGS). The International Regulations for Preventing Collisions at Sea, 1960, were replaced by the 72 COLREGS at 1200 hours, zone time on July 15, 1977. Therefore, all U.S. vessels on the high seas must comply with the 72 COLREGS at this time.

Rules 21 and 22 of the 72 COLREGS, give the color and range requirements for various navigation lights, Annex I to the 72 COLREGS, gives positioning and technical details for these lights.

For existing vessels, over 20 meters (65.7 ft), whose keels were laid before July 15, 1977, Rule 38 of the 72 COLREGS allows a phase-in period and in certain cases, a permanent exemption from various navigation light requirements.

New vessels over 20 meters (65.7 ft), the keels of which were laid after July 15, 1977, are subject to the 72 COLREGS and may no longer install navigation lights listed in U.S.C.G. -293 unless, it has been determined by the Commandant that they meet 72 COLREGS.

Presently the U.S. Coast Guard and the Underwriters Laboratories are working to develop complete test procedures for the 72 COLREGS. Therefore, the U.S. Coast Guard has implemented an interim acceptance program. Interim acceptance indicates the lights have been tested and comply with paragraphs 7, 8, 9 and 10 of Annex I of the 72 COLREGS and may be installed on vessels the keel of which was laid after July 15, 1977 to July 15, 1978 or one year after U.L. Standard No. 1104 becomes effective, whichever is later.

On the following pages many of the lights listed are marked with the symbol \*\* IA \*\* which means they have been granted interim acceptance. Some of these lights can be installed on vessels from 20 to 50 meters (65.7 ft. to 164.1 ft.) or over 50 meters. Each of the charts on the following pages indicate the size of vessel the lights can be used on and each interim accepted light is shipped with complete data on bulbs, technical details, and vessel length.

Lights in this section not marked \*\* IA \*\* are offered for use where the vessel is subject to "Rules of the Road, C.G. 169 Inland Section," "Western Rivers C.G. 184" or "Great Lakes C.G. 172" or may possibly be used on existing vessels where they comply with Rule 38 of the 72 COLREGS.

The U.S. Coast Guard will not publish an interim acceptance list, however Field Offices have been notified. For more detailed information, consult the complete 72 COLREGS or your local Coast Guard office.



## \*\*IA\*\*

THE LIGHTS LISTED ON THIS PAGE HAVE BEEN GIVEN INTERIM ACCEPTANCE BY THE U.S. COAST GUARD FOR USE ON ALL VESSELS OVER 20 METERS (65.7 ft.) — SEE PAGE B-2 FOR DETAILS ON THE INTERIM ACCEPTANCE PROGRAM.

### SINGLE AND DOUBLE LENS NAVIGATION LIGHTS CAST BRONZE — WATERTIGHT — ELECTRIC

Each section contains a Medium Screw Lamp Socket, a watertight terminal tube for cable entrance and watertight access cap for rebulbing and cleaning. Bulbs Not Included.

#### DOUBLE LENS TYPE



SINGLE LENS TYPE

Single Lens  
Double Lens

Height  
Overall  
Inches

10  
18

Height  
Lens  
Inches

6-3/4  
6-3/4

Weight  
Pounds

12  
24

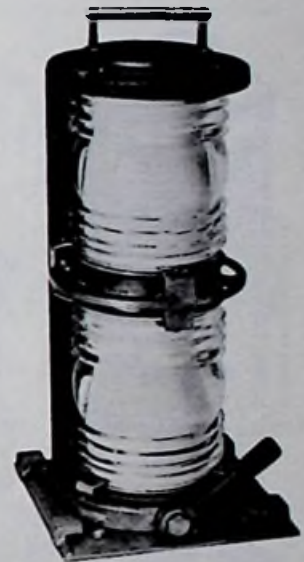

Single  
Lens

Double  
Lens

For Vessels  
20 Meters to 50 Meters  
(65.7 ft. to 164.1 ft.)

For Vessels  
Over 50 Meters  
(164.1 ft.)

Fig. No.	Fig. No.	Description	Visibility Arc	Visibility Miles	Required Wattage*	Visibility Miles	Required Wattage*
1172-RB	1164-RB	Red Side Light	112½°	2	25	3	40
1172-GB	1164-GB	Green Side Light	112½°	2	25	3	40
1173-B	1165-B	White Masthead Light	225°	5	40	6	60
1174-B	1166-B	White Stern Light	135°	2	15	3	15
1174-MB	1166-MB	Yellow Towing Light	135°	2	15	3	15
1169-B	1167-B	White All-Round Light	360°	2	15	3	15
1170-RB	1168-RB	Red All-Round Light	360°	2	25	3	40
1170-GB	1168-GB	Green All-Round Light	360°	2	25	3	40
1170-MB	1168-MB	Yellow All-Round Light	360°	2	15	3	15

NOTE: THESE LIGHTS MAY ALSO BE USED ON VESSELS THE KEELS OF WHICH WERE LAID PRIOR TO JULY 15, 1977.

#### \*BULB DATA FOR \*\*IA\*\* LIGHTS

The Above Lights must use Bulb Type T-10, Medium Screw Base, C-8 filament, Clear, 120 Volts, as follows:

Fig. No.	Wattage	Mfg. No.
340-20	15	15T10
340-21	25	25T10
340-22	40	40T10
340-23	60	60T10/64

#### SPARE PARTS

Caps with Gasket, Fig. 1141  
Cap Gaskets Only, Fig. 1142  
Lens Gasket, Fig. 1143  
Lenses, See Fig. 261, No. 1  
Medium Screw Sockets, See Fig. 369

**\*\*IA\*\***

THE LIGHTS LISTED ON THIS PAGE HAVE BEEN GIVEN INTERIM ACCEPTANCE BY THE U.S. COAST GUARD FOR USE ON ALL VESSELS OVER 20 METERS (65.7 ft.) — SEE PAGE B-2 FOR DETAILS ON THE INTERIM ACCEPTANCE PROGRAM.

## ELECTRIC NAVIGATION LIGHTS

Brass or Galvanized Steel Body — Cast Bronze Rebulbing Cap — Medium Screw Lamp Socket — Terminal Tube for Cable Entrance — Bulbs Not Included

Size No.	Galvanized Steel Each	Plain Brass Each	Polished Brass Each	Nominal Height Lens Inches	Nominal Height Light Inches	Nominal Weight Pounds
1				6-3/4	11-1/2	8
2				7-1/2	13-1/2	12



Red & Green Side Lights  
112½ Degrees



Masthead Lights  
225 Degrees



Stern or Towing Lights  
135 Degrees



All-Round Lights  
360 Degrees

**For Vessels 20 Meters to 50 Meters  
(65.7 ft. to 164.1 ft.)**

Fig. No.	Description	Visibility Arc	Visibility Miles	Required Wattage*
1150-RB1	Red Side Light	112½°	2	15 clear
1150-GB1	Green Side Light	112½°	2	15 clear
1151-B01	White Masthead Light	225°	5	40 clear
1152-B01	White Stern Light	135°	2	15 clear
1152-MB1	Yellow Towing Light	135°	2	15 clear
1153-B01	White All-Round Light	360°	2	25 frosted
1154-RB1	Red All-Round Light	360°	2	40 frosted
1154-GB1	Green All-Round Light	360°	2	40 frosted
1154-MB1	Yellow All-Round Light	360°	2	25 frosted

**For Vessels Over 50 Meters  
(164.1 ft.)**

Fig. No.	Description	Visibility Arc	Visibility Miles	Required Wattage*
1150-RB2	Red Side Light	112½°	3	40 clear
1150-GB2	Green Side Light	112½°	3	60 clear
1151-B02	White Masthead Light	225°	6	60 clear
1152-B02	White Stern Light	135°	3	15 clear
1152-MB2	Yellow Towing Light	135°	3	25 clear
1153-B02	White All-Round Light	360°	3	25 frosted
1154-RB2	Red All-Round Light	360°	3	60 frosted
1154-GB2	Green All-Round Light	360°	3	60 frosted
1154-MB2	Yellow All-Round Light	360°	3	40 frosted

**\*BULB DATA FOR \*\*IA\*\* LIGHTS**

The Above Lights must use Bulb Type T-10, Medium Screw Base, C-8 filament, 120 Volts, as follows:

Fig. No.	Wattage	Mfg. No.
340-20	15 clear	15T10
340-21	25 clear	25T10
340-22	40 clear	40T10
340-23	60 clear	60T10/64
340-24	25 frosted	25T10/IF
340-25	40 frosted	40T10/IF
340-26	60 frosted	60T10/IF

NOTE: THESE LIGHTS MAY ALSO BE USED ON VESSELS THE KEELS OF WHICH WERE LAID PRIOR TO JULY 15, 1977.

**SPARE PARTS**

112½° Lenses, See Fig. 259, Nos. 1 or 2  
135° Lenses, See Fig. 269, Nos. 1 or 2  
225° Lenses, See Fig. 258, Nos. 1 or 2  
360° Lenses, See Fig. 261, Nos. 1 or 2

Bronze Caps with Gasket, Specify Fig. 1160  
Medium Screw Sockets, See Fig. 346, No.2  
Socket Supports, See Fig. 341  
Mounting Brackets, See Fig. 143

## \*\*IA\*\*

THE LIGHTS LISTED ON THIS PAGE HAVE BEEN GIVEN INTERIM ACCEPTANCE BY THE U.S. COAST GUARD FOR USE ON ALL VESSELS OVER 20 METERS (65.7 ft.) — SEE PAGE B-2 FOR DETAILS ON THE INTERIM ACCEPTANCE PROGRAM.

### ELECTRIC NAVIGATION LIGHTS

Brass or Galvanized Steel Body — Bottom Opening — Medium Screw Lamp Socket  
Bulbs Not Included

Size No.	Galvanized Steel Each	Plain Brass Each	Polished Brass Each	Nominal Height Lens Inches	Nominal Height Light Inches	Nominal Weight Pounds
1				6-3/4	11	6
2				7-1/2	13	9

#### For Vessels 20 Meters to 50 Meters (65.7 ft. to 164.1 ft.)

Fig. No.	Description	Visibility Arc	Visibility Miles	Required Wattage*
30-RB1	Red Side Light	112½°	2	15 clear
30-GB1	Green Side Light	112½°	2	15 clear
983-B01	White Masthead Light	225°	5	40 clear
986-B01	White Stern Light	135°	2	15 clear
986-MB1	Yellow Towing Light	135°	2	15 clear
32-B01	White All-Round Light	360°	2	25 frosted
84-RB1	Red All-Round Light	360°	2	40 frosted
84-GB1	Green All-Round Light	360°	2	40 frosted
84-MB1	Yellow All-Round Light	360°	2	25 frosted



Red & Green Side Lights  
112½ Degrees



Masthead Lights  
225 Degrees

#### For Vessels Over 50 Meters (164.1 ft.)

Fig. No.	Description	Visibility Arc	Visibility Miles	Required Wattage*
30-RB2	Red Side Light	112½°	3	40 clear
30-GB2	Green Side Light	112½°	3	60 clear
983-B02	White Masthead Light	225°	6	60 clear
986-B02	White Stern Light	135°	3	15 clear
986-MB2	Yellow Towing Light	135°	3	25 clear
32-B02	White All-Round Light	360°	3	25 frosted
84-RB2	Red All-Round Light	360°	3	60 frosted
84-GB2	Green All-Round Light	360°	3	60 frosted
84-MB2	Yellow All-Round Light	360°	3	40 frosted



Stern or Towing Lights  
135 Degrees



All-Round Lights  
360 Degrees

#### \*BULB DATA FOR \*\*IA\*\* LIGHTS

The Above Lights must use Bulb Type T-10, Medium Screw Base, C-8 filament, 120 Volts, as follows:

Fig. No.	Wattage	Mfg. No.
340-20	15 clear	15T10
340-21	25 clear	25T10
340-22	40 clear	40T10
340-23	60 clear	60T10/64
340-24	25 frosted	25T10/1F
340-25	40 frosted	40T10/1F
340-26	60 frosted	60T10/1F



Electric Adapter  
In Base of Light

NOTE: THESE LIGHTS MAY ALSO BE USED ON VESSELS THE KEELS OF WHICH WERE LAID PRIOR TO JULY 15, 1977.

#### SPARE PARTS

112½° Lenses, See Fig. 259, Nos. 1 or 2  
135° Lenses, See Fig. 269, Nos. 1 or 2  
225° Lenses, See Fig. 258, Nos. 1 or 2  
360° Lenses, See Fig. 261, Nos. 1 or 2

Medium Screw Adapters, See Fig. 288  
Medium Screw Sockets, See Fig. 346, No. 2  
Mounting Brackets, See Fig. 143

**\*\*IA\*\***

THE LIGHTS LISTED ON THIS PAGE HAVE BEEN GIVEN INTERIM ACCEPTANCE BY THE U.S. COAST GUARD FOR USE ON ALL VESSELS OVER 20 METERS (65.7 ft.) — SEE PAGE B-2 FOR DETAILS ON THE INTERIM ACCEPTANCE PROGRAM.

**ELECTRIC NAVIGATION LIGHTS**

Brass or Galvanized Steel Body — Bottom Opening — Medium Screw Lamp Socket  
Bulbs Not Included

Size No.	Galvanized Steel Each	Plain Brass Each	Polished Brass Each	Nominal Height Lens Inches	Nominal Height Light Inches	Nominal Weight Pounds
1				6-3/4	15	7
2				7-1/2	18	10-1/2



Red & Green Side Lights  
112½ Degrees



Masthead Lights  
225 Degrees



Stern or Towing Lights  
135 Degrees



All-Round Lights  
360 Degrees



Electric Adapter  
In Base of Light

For Vessels 20 Meters to 50 Meters  
(65.7 ft. to 164.1 ft.)

Fig. No.	Description	Visibility Arc	Visibility Miles	Required Wattage*
21-RB1	Red Side Light	112½°	2	15 clear
21-GB1	Green Side Light	112½°	2	15 clear
982-B01	White Masthead Light	225°	5	40 clear
985-B01	White Stern Light	135°	2	15 clear
985-MB1	Yellow Towing Light	135°	2	15 clear
23-B01	White All-Round Light	360°	2	25 frosted
129-RB1	Red All-Round Light	360°	2	40 frosted
129-GB1	Green All-Round Light	360°	2	40 frosted
129-MB1	Yellow All-Round Light	360°	2	25 frosted

For Vessels Over 50 Meters  
(164.1 ft.)

Fig. No.	Description	Visibility Arc	Visibility Miles	Required Wattage*
21-RB2	Red Side Light	112½°	3	40 clear
21-GB2	Green Side Light	112½°	3	60 clear
982-B02	White Masthead Light	225°	6	60 clear
985-B02	White Stern Light	135°	3	15 clear
985-MB2	Yellow Towing Light	135°	3	25 clear
23-B02	White All-Round Light	360°	3	25 frosted
129-RB2	Red All-Round Light	360°	3	60 frosted
129-GB2	Green All-Round Light	360°	3	60 frosted
129-MB2	Yellow All-Round Light	360°	3	40 frosted

**\*BULB DATA FOR\*\* IA\*\* LIGHTS**

The Above Lights must use Bulb Type T-10, Medium Screw Base, C-8 filament, 120 Volts, as follows:

Fig. No.	Wattage	Mfg. No.
340-20	15 clear	15T10
340-21	25 clear	25T10
340-22	40 clear	40T10
340-23	60 clear	60T10/64
340-24	25 frosted	25T10/IF
340-25	40 frosted	40T10/IF
340-26	60 frosted	60T10/IF

NOTE: THESE LIGHTS MAY ALSO BE USED ON VESSELS THE KEELS OF WHICH WERE LAID PRIOR TO JULY 15, 1977.

**SPARE PARTS**

112½° Lenses, See Fig. 259, Nos. 1 or 2  
135° Lenses, See Fig. 260, Nos. 1 or 2  
225° Lenses, See Fig. 258, Nos. 1 or 2  
360° Lenses, See Fig. 261, Nos. 1 or 2

Medium Screw Adapters, See Fig. 288  
Medium Screw Sockets, See Fig. 346, No. 2  
Mounting Brackets, See Fig. 143

### \*\*IA\*\*

THE LIGHTS LISTED ON THIS PAGE HAVE BEEN GIVEN INTERIM ACCEPTANCE BY THE U.S. COAST GUARD FOR USE ON ALL VESSELS FROM 20 METERS TO 50 METERS (65.7 ft. to 164.1 ft.) — SEE PAGE B-2 FOR DETAILS ON THE INTERIM ACCEPTANCE PROGRAM.

**ELECTRIC NAVIGATION LIGHTS — FOR VESSELS 20 TO 50 METERS (65.7 ft. to 164.1 ft.) SHEET METAL — GALVANIZED STEEL, POLISHED BRASS OR BRASS CHROMIUM PLATED BOTTOM OPENING — ELECTRIC SOCKET IS SINGLE CONTACT PREFOCUS FOR 12 VOLT USE ONLY — BULBS NOT INCLUDED**

Fig. No.	Description	Visibility Arc	Visibility Miles	Required * Bulb Amperage
4-RD3	Red Side Light	112½°	2	.77A
4-GD3	Green Side Light	112½°	2	.77A
5-D03	White Masthead Light	225°	5	2.03A
7-D03	White Stern Light	135°	2	.55A
7-MD3	Yellow Towing Light	135°	2	.55A

Height Inches	Height Lens Inches	Weight Pounds Each
8-1/2	5-3/16	3-1/4



Red & Green Side Lights  
112½ Degrees



Stern or Towing Lights  
135 Degrees



Masthead Lights  
225 Degrees

NOTE: WHEN ORDERING, SPECIFY FINISH.

\*BULB DATA FOR FIGS. 4, 5 & 7 \*\*IA\*\* LIGHTS  
The Above lights Must Use Bulb Type S-8, Single Contact Prefocus, C-8 Filament, Clear, 12 Volts, as follows:

Fig. No.	Amperage	Mfg. No.
373-2	.55	55A/S8
373-3	.77	77A/S8
373-5	2.03	2.03A/S8SCP

**ALL-ROUND LIGHTS — FOR VESSELS 20 TO 50 METERS (65.7 ft. to 164.1 ft.) CAST BRONZE — PLAIN OR CHROMIUM PLATED — ELECTRIC SOCKET IS MEDIUM SCREW FOR 12 VOLT USE ONLY — BULBS NOT INCLUDED**

Fig. No.	Height Overall Inches	Diameter Base Inches	Tapped Pipe Size Inches	Weight Pounds
112	8-3/4	3-1/8	—	3-3/4
309	6-1/2	—	1/2	2-1/2

NOTE: WHEN ORDERING, SPECIFY FINISH.

#### Figs. 112 & 309 — BULB DATA

Fig. No.	Description	Visibility Miles	Required Wattage	Bulb Fig. No.
112 & 309	White All-Round Light	2	15 frosted	340-5
112M & 309M	Yellow All-Round Light	2	15 frosted	340-5
112R & 309R	Red All-Round Light	2	25 frosted	340-6
112G & 309G	Green All-Round Light	2	25 frosted	340-6



Fig. 112



Fig. 309

All-Round Lights  
360 Degrees

Above Lights Must Use Bulb Type A-17, Medium Screw Base, 12 Volt, Frosted Bulbs.

#### SPARE PARTS

Lenses For Fig. 4, See Fig. 259, Class 3.  
Lenses for Fig. 5, See Fig. 256, Class 3.  
Lenses for Fig. 7, See Fig. 269, Class 3.  
Globes For Figs. 112 & 309, See Fig. 106.

Bulbs For Figs. 4, 5 & 7, Specify Fig. 373 and Size.  
Bulbs, For Figs. 112 & 309, Specify Fig. 340 and Size.  
S. C. Prefocus Adapter, Specify Fig. 294 No. 3  
Mounting Brackets, Specify Fig. 131 and Finish.

## \*\*IA\*\*

THE LIGHTS LISTED ON THIS PAGE HAVE BEEN GIVEN INTERIM ACCEPTANCE BY THE U.S. COAST GUARD FOR USE ON ALL VESSELS OVER 20 METERS (65.7 ft.) — SEE PAGE B-2 FOR DETAILS ON THE INTERIM ACCEPTANCE PROGRAM.

### ALL-ROUND LIGHTS CAST BRONZE — MEDIUM SCREW ELECTRIC SOCKET BULBS NOT INCLUDED



Fig. 403  
Fig. 454



Fig. 412

#### ALL-ROUND LIGHTS — Figs. 403, 412 & 454

Fig. No.	Height Overall Inches	Height Lens Inches	Tapped Pipe Size Inches	Weight Pounds
403-2	9	4-1/4	3/4	6-1/2
403-3	11-1/2	6-3/4	1	9-1/2
412	14	6-3/4	—	11-1/2
454	11-1/2	6-3/4	1	9-1/2

For Vessels 20 Meters to 50 Meters  
(65.7 ft. to 164.1 ft.)

Fig. No.	Description	Visibility Miles	Required Wattage*
403-B02	White All-Round Light	2	25 frosted
403-RB2	Red All-Round Light	2	40 frosted
403-GB2	Green All-Round Light	2	40 frosted
403-MB2	Yellow All-Round Light	2	25 frosted
412-B	White All-Round Light	2	25 frosted
412-RB	Red All-Round Light	2	40 frosted
412-GB	Green All-Round Light	2	40 frosted
412-MB	Yellow All-Round Light	2	25 frosted

For Vessels Over 50 Meters  
(164.1 ft.)

Fig. No.	Description	Visibility Miles	Required Wattage*
403-B03	White All-Round Light	3	40 frosted
403-RB3	Red All-Round Light	3	60 frosted
403-GB3	Green All-Round Light	3	60 frosted
403-MB3	Yellow All-Round Light	3	40 frosted
412-B	White All-Round Light	3	40 frosted
412-RB	Red All-Round Light	3	60 frosted
412-GB	Green All-Round Light	3	60 frosted
412-MB	Yellow All-Round Light	3	40 frosted

**FIG. 454-B White Whistle Light —**  
Visibility 5 miles with 75 watt Soft White,  
A-19, CC-6 filament, medium screw base bulb.

#### SPARE PARTS

Lens for Fig. 403-2, See Fig. 281 Senior.  
Lenses for Figs. 403-3, 412, 454, See Fig. 281 No. 1.  
Medium Screw Socket for Fig. 403-2, See Fig. 348 No. 2.  
Medium Screw Sockets for Figs. 403-3, 412, 454, See Fig. 389.  
Cover Gasket for Fig. 403 No.2, Specify Fig. 1140 Size 1.  
Cover Gasket for Figs. 403 No. 3, 412, 454, Specify Fig. 1140 Size 2.

#### \*BULB DATA FOR ABOVE LIGHTS

Figs. 403 and 412 must use Bulb Type T-10, Medium Screw Base, C-8 Filament, frosted, 120 volts, as follows:

Fig. No.	Wattage	Mfg. No.
340-24	25	25T10/IF
340-25	40	40T10/IF
340-26	60	60T10/IF

**IMPORTANT INFORMATION**

THE ELECTRIC NAVIGATION AND SIGNAL LIGHTS SHOWN ON THE FOLLOWING PAGES ARE DESIGNED TO MEET INLAND AND INTERNATIONAL REQUIREMENTS PRIOR TO 72 COLREGS. THEY CAN BE USED ON VESSELS THE KEELS OF WHICH WERE LAID PRIOR TO JULY 15, 1977 PER RULE 38 OF THE 72 COLREGS. THEY MAY BE USED FOR SPECIAL PURPOSES, CONSULT C.G. 169 — INLAND SECTION, C.G. 172 — GREAT LAKES, C.G. 184 — WESTERN RIVERS OR YOUR LOCAL COAST GUARD OFFICE FOR FURTHER DETAILS.

THE ELECTRIC LIGHTS SHOWN ON THE PRECEEDING PAGES ARE INTERIM ACCEPTED FOR USE ON VESSELS CONSTRUCTED ON OR AFTER JULY 15, 1977 BUT, THEY MAY ALSO BE USED ON VESSELS EXISTING PRIOR TO THAT DATE.

THE OIL LIGHTS SHOWN ON THE FOLLOWING PAGES MAY BE USED ONLY AS EMERGENCY LIGHTS FOR NEW OR EXISTING VESSELS.

The wattages shown in the following tables are recommended to meet the visibility requirements.

<u>TYPE OF LIGHT</u>	<u>COLOR</u>	<u>DEGREES OF VISIBILITY</u>	<u>POINTS OF COMPASS</u>	<u>DISTANCE OF VISIBILITY IN MILES</u>	<u>RECOMMENDED WATTAGE</u>
Port Side	Red	112-1/2	10	2	100
Starboard Side	Green	112-1/2	10	2	100
Masthead, Range and Towing	White	225	20	5	100
Masthead, Range and Towing	Red or Amber*	225	20	2	100
Stern	White	135	12	2	50
Stern	Red or Amber*	135	12	2	100
Anchor	White	360	32	3	50
Breakdown or Not-Under-Command	Red	360	32	2	100

We do not supply lamps with the above lights. To obtain the degrees and distances of visibility, the filament of the lamp must be located at the focal center of the lens in a vertical and horizontal plane. We recommend the following: For 2-wire medium screw socket, a clear single filament A-19 lamp with 3-1/8" L.C.L. (Light Center Length). For a 3-wire mogul socket, a clear double filament P-25 lamp for marine lighting purposes. The sockets in our lights are labeled accordingly.

NOTE—Above data and results are based on the use of Fresnel Lenses.

\*The 72 COLREGS refer to Amber for Inland rules and yellow for International rules — our lenses meet both requirements.

The lights referred to above comply with paragraphs 248, 251, 252, 263, 265 and 266 of Underwriters Laboratories, Inc. UL — 595 "Standard for Marine Type Electric Lighting Fixtures."

We suggest that the following should be kept available for reference. They are obtained from the local office of the U.S.C.G.

"Rules of the Road"  
 C.G. 169 — International and Inland  
 C.G. 172 — Great Lakes  
 C.G. 184 — Western Rivers

THE LIGHTS LISTED ON THIS PAGE CAN BE USED ON VESSELS OVER 65 ft. LONG THE KEELS OF WHICH WERE LAID PRIOR TO JULY 15, 1977. FOR DETAILED INFORMATION CONSULT "RULES OF THE ROAD," C.G. 169 - INLAND SECTION, C.G. 172 - GREAT LAKES, C.G. 184 - WESTERN RIVERS, OR CONTACT YOUR LOCAL COAST GUARD OFFICE.

## SINGLE AND DOUBLE LENS NAVIGATION LIGHTS CAST BRONZE — WATERTIGHT — ELECTRIC

Each section contains a phenolic Lamp Socket, a watertight terminal tube for cable entrance and a watertight access cap for rebulbing and cleaning. Bulbs Not Included.

### DOUBLE LENS TYPE



	Height Overall Inches	Height Lens Inches	Weight Pounds
Double Lens	18	6-3/4	24
Single Lens	10	6-3/4	12

### BULB DATA

The lights listed on this page must use Clear bulbs with 3-1/8" Light Center length as follows:

Fig. No.	Base Design	Wattage	Mfg. No.
340-17	Medium Screw	60	60A/CL A-19
340-19	Medium Screw	100	100A/CL A-19
532-1	Mogul Screw	50	P25/28
532-2	Mogul Screw	100	P25/29



### SINGLE LENS TYPE

#### Double Lens Type with Medium Screw Sockets

Fig. No.	Description	Visibility Arc	Visibility Miles	Wattage
1165-RB	Red Masthead Light	225°	2	100
1165-MB	Yellow Masthead Light	225°	2	100
*1165-RBL	White/Red Masthead Light	225°	5/2	100/100
1166-RB	Red Stern Light	135°	2	100
*1166-RBL	White/Red All-Round Light	360°	3/2	60/100

#### Single Lens Type with Medium Screw Socket

1171-RB	Red Dredging Light	45°	2	100
1173-RB	Red Masthead Light	225°	2	100
1173-MB	Yellow Masthead Light	225°	2	100
1174-RB	Red Stern Light	135°	2	100

#### Single Lens Type with Mogul Screw Socket

1172-RC	Red Side Light	112½°	2	100
1172-GC	Green Side Light	112½°	2	100
1173-C	White Masthead Light	225°	5	100
1173-RC	Red Masthead Light	225°	2	100
1173-MC	Yellow Masthead Light	225°	2	100
1174-C	White Stern Light	135°	2	50
1174-RC	Red Stern Light	135°	2	100
1174-MC	Yellow Stern Light	135°	2	100
1169-C	White Anchor Light	360°	3	50
1170-RC	Red All-Round Light	360°	2	100
1171-RC	Red Dredging Light	45°	2	100

\*OUR STANDARD IS WHITE ON TOP, RED ON BOTTOM. IF REQUIRED OTHERWISE, PLEASE SPECIFY. THESE CAN BE SUPPLIED WITH MOGUL SOCKET. USE LETTERS RCL AFTER FIG. NO.

### SPARE PARTS

Lenses, See Fig. 261 No. 1  
 Medium Screw Sockets, See Fig. 369  
 Mogul Sockets, See Fig. 270  
 Caps with Gasket, Fig. 1141  
 Cap Gaskets Only, Fig. 1142  
 Lens Gaskets, Fig. 1143



THE LIGHTS LISTED ON THIS PAGE CAN BE USED ON VESSELS OVER 65 FT. LONG THE KEELS OF WHICH WERE LAID PRIOR TO JULY 15, 1977. FOR DETAILED INFORMATION CONSULT "RULES OF THE ROAD," C.G. 169 - INLAND SECTION, C.G. 172 - GREAT LAKES, C.G. 184 - WESTERN RIVERS, OR CONTACT YOUR LOCAL COAST GUARD OFFICE.

## ELECTRIC NAVIGATION LIGHTS FOR VESSELS OVER 65 FT. LONG

Waterproof — Cast Bronze Rebulbing Cap — Terminal Tubes  
LAMP SOCKETS — MEDIUM SCREW 2 WIRE OR MOGUL 3 WIRE — LAMPS NOT INCLUDED

Size No.	Galvanized Steel Each	Plain Brass Each	Polished Brass Each	Nominal Height Lens Inches	Nominal Height Light Inches	Nominal Weight Pounds
1				6-3/4	11-1/2	8
2				7-1/2	13-1/2	12

### Recommended For Vessels 20 Meters to 50 Meters (65.7 ft. to 164.1 ft.)

#### With Medium Screw Socket

Fig. No.	Description	Visibility Arc	Visibility Miles	Wattage
1151-RB1	Red Masthead Light	225°	2	100
1151-MB1	Yellow Masthead Light	225°	2	100
1152-RB1	Red Stern Light	135°	2	100

#### With Mogul Screw Socket

1150-RC1	Red Side Light	112½°	2	100
1150-GC1	Green Side Light	112½°	2	100
1151-C01	White Masthead Light	225°	5	100
1151-RC1	Red Masthead Light	225°	2	100
1151-MC1	Yellow Masthead Light	225°	2	100
1152-C01	White Stern Light	135°	2	50
1152-RC1	Red Stern Light	135°	2	100
1152-MC1	Yellow Stern Light	135°	2	100
1153-C01	White All-Round Light	360°	3	50
1154-RC1	Red All-Round Light	360°	2	100



Red & Green Side Lights  
112½ Degrees



Masthead Lights  
225 Degrees



Stern or Towing Lights  
135 Degrees



All-Round Lights  
360 Degrees

### Recommended For Vessels Over 50 Meters (164.1 ft.)

#### With Medium Screw Socket

Fig. No.	Description	Visibility Arc	Visibility Miles	Wattage
1151-RB2	Red Masthead Light	225°	2	100
1151-MB2	Yellow Masthead Light	225°	2	100
1152-RB2	Red Stern Light	135°	2	100

#### With Mogul Screw Socket

1150-RC2	Red Side Light	112½°	2	100
1150-GC2	Green Side Light	112½°	2	100
1151-C02	White Masthead Light	225°	5	100
1151-RC2	Red Masthead Light	225°	2	100
1151-MC2	Yellow Masthead Light	225°	2	100
1152-C02	White Stern Light	135°	2	50
1152-RC2	Red Stern Light	135°	2	100
1152-MC2	Yellow Stern Light	135°	2	100
1153-C02	White All-Round Light	360°	3	50
1154-RC2	Red All-Round Light	360°	2	100

#### BULB DATA

The lights listed on this page must use Clear Bulbs with 3-1/8" Light Center length as follows:

Fig. No.	Base Design	Wattage	Mfg. No.
340-19	Medium Screw	100	100A/CL A-19
532-1	Mogul Screw	50	P25/28
532-2	Mogul Screw	100	P25/29

#### SPARE PARTS

112½° Lenses, See Fig. 259, Nos. 1 or 2  
135° Lenses, See Fig. 289, Nos. 1 or 2  
225° Lenses, See Fig. 256, Nos. 1 or 2  
360° Lenses, See Fig. 261, Nos. 1 or 2  
Bronze Caps with Gasket, Specify Fig. 1160

Medium Screw Sockets, See Fig. 346, No. 2  
Mogul Sockets, See Fig. 270  
Socket Supports, See Fig. 341  
Mounting Brackets, See Fig. 143

**THE LIGHTS LISTED ON THIS PAGE CAN BE USED ON VESSELS OVER 65 FT. LONG THE KEELS OF WHICH WERE LAID PRIOR TO JULY 15, 1977. FOR DETAILED INFORMATION CONSULT "RULES OF THE ROAD," C.G. 169 - INLAND SECTION, C.G. 172 - GREAT LAKES, C.G. 184 - WESTERN RIVERS, OR CONTACT YOUR LOCAL COAST GUARD OFFICE.**

**ELECTRIC NAVIGATION LIGHTS FOR VESSELS OVER 65 FT. LONG  
Flat Top Style — Bottom Opening  
LAMP SOCKETS — MEDIUM SCREW 2 WIRE OR MOGUL 3 WIRE — LAMPS NOT INCLUDED**

Size No.	Galvanized Steel Each	Plain Brass Each	Polished Brass Each	Nominal Height Lens Inches	Nominal Height Light Inches	Nominal Weight Pounds
1				6-3/4	11	6
2				7-1/2	13	9



**Red & Green Side Lights  
112½ Degrees**



**Masthead Lights  
225 Degrees**



**Electric Adapter  
In Base of Light**



**Stern or Towing Lights  
135 Degrees**



**All-Round Lights  
360 Degrees**

**Recommended For Vessels 20 Meters to 50 Meters  
(65.7 ft. to 164.1 ft.)**

With Medium Screw Socket

Fig. No.	Description	Visibility Arc	Visibility Miles	Wattage
983-RB1	Red Masthead Light	225°	2	100
983-MB1	Yellow Masthead Light	225°	2	100
986-RB1	Red Stern Light	135°	2	100

With Mogul Screw Socket

30-RC1	Red Side Light	112½°	2	100
30-GC1	Green Side Light	112½°	2	100
983-C01	White Masthead Light	225°	5	100
983-RC1	Red Masthead Light	225°	2	100
983-MC1	Yellow Masthead Light	225°	2	100
986-C01	White Stern Light	135°	2	50
986-RC1	Red Stern Light	135°	2	100
986-MC1	Yellow Stern Light	135°	2	100
32-C01	White All-Round Light	360°	3	50
84-RC1	Red All-Round Light	360°	2	100

**Recommended For Vessels Over 50 Meters  
(164.1 ft.)**

With Medium Screw Socket

Fig. No.	Description	Visibility Arc	Visibility Miles	Wattage
983-RB2	Red Masthead Light	225°	2	100
983-MB2	Yellow Masthead Light	225°	2	100
986-RB2	Red Stern Light	135°	2	100

With Mogul Screw Socket

30-RC2	Red Side Light	112½°	2	100
30-GC2	Green Side Light	112½°	2	100
983-C02	White Masthead Light	225°	5	100
983-RC2	Red Masthead Light	225°	2	100
983-MC2	Yellow Masthead Light	225°	2	100
986-C02	White Stern Light	135°	2	50
986-RC2	Red Stern Light	135°	2	100
986-MC2	Yellow Stern Light	135°	2	100
32-C02	White All-Round Light	360°	3	50
84-RC2	Red All-Round Light	360°	2	100

**BULB DATA**

The lights listed on this page must use Clear Bulbs with 3-1/8" Light Center length as follows:

Fig. No	Base Design	Wattage	Mfg. No.
340-19	Medium Screw	100	100A/CL A-19
532-1	Mogul Screw	50	P25/28
532-2	Mogul Screw	100	P25/29

**SPARE PARTS**

112½° Lenses, See Fig. 259, Nos. 1 or 2  
135° Lenses, See Fig. 289, Nos. 1 or 2  
225° Lenses, See Fig. 258, Nos. 1 or 2  
360° Lenses, See Fig. 281, Nos. 1 or 2  
Medium Screw Adapters, See Fig. 288

Mogul Adapters, See Fig. 1082  
Medium Screw Sockets, See Fig. 346 No. 2  
Mogul Sockets, See Fig. 270  
Mounting Brackets, See Fig. 143

THE LIGHTS LISTED ON THIS PAGE CAN BE USED ON VESSELS OVER 65 ft. LONG THE KEELS OF WHICH WERE LAID PRIOR TO JULY 15, 1977. FOR DETAILED INFORMATION CONSULT "RULES OF THE ROAD," C.G. 169 - INLAND SECTION, C.G. 172 - GREAT LAKES, C.G. 184 - WESTERN RIVERS, OR CONTACT YOUR LOCAL COAST GUARD OFFICE.

## ELECTRIC NAVIGATION LIGHTS FOR VESSELS OVER 65 FT. LONG TURRET TOP — BOTTOM OPENING LAMP SOCKETS — MEDIUM SCREW 2 WIRE OR MOGUL 3 WIRE — LAMPS NOT INCLUDED

Size No.	Galvanized Steel Each	Plain Brass Each	Polished Brass Each	Nominal Height Lens Inches	Nominal Height Light Inches	Nominal Weight Pounds
1				6-3/4	15	7
2				7-1/2	18	10-1/2

### Recommended For Vessels 20 Meters to 50 Meters (65.7 ft. to 164.1 ft.)

#### With Medium Screw Socket

Fig. No.	Description	Visibility Arc	Visibility Miles	Wattage
982-RB1	Red Masthead Light	225°	2	100
982-MB1	Yellow Masthead Light	225°	2	100
985-RB1	Red Stern Light	135°	2	100

#### With Mogul Screw Socket

21-RC1	Red Side Light	112½°	2	100
21-GC1	Green Side Light	112½°	2	100
982-C01	White Masthead Light	225°	5	100
982-RC1	Red Masthead Light	225°	2	100
982-MC1	Yellow Masthead Light	225°	2	100
985-C01	White Stern Light	135°	2	50
985-RC1	Red Stern Light	135°	2	100
985-MC1	Yellow Stern Light	135°	2	100
23-C01	White All-Round Light	360°	3	50
129-RC1	Red All-Round Light	360°	2	100



Red & Green Side Lights  
112½ Degrees



Masthead Lights  
225 Degrees



Stern or Towing Lights  
135 Degrees



All-Round Lights  
360 Degrees

### Recommended For Vessels Over 50 Meters (164.1 ft.)

#### With Medium Screw Socket

Fig. No.	Description	Visibility Arc	Visibility Miles	Wattage
982-RB2	Red Masthead Light	225°	2	100
982-MB2	Yellow Masthead Light	225°	2	100
985-RB2	Red Stern Light	135°	2	100

#### With Mogul Screw Socket

21-RC2	Red Side Light	112½°	2	100
21-GC2	Green Side Light	112½°	2	100
982-C02	White Masthead Light	225°	5	100
982-RC2	Red Masthead Light	225°	2	100
982-MC2	Yellow Masthead Light	225°	2	100
985-C02	White Stern Light	135°	2	50
985-RC2	Red Stern Light	135°	2	100
985-MC2	Yellow Stern Light	135°	2	100
23-C02	White All-Round Light	360°	3	50
129-RC2	Red All-Round Light	360°	2	100

#### BULB DATA

The lights listed on this page must use Clear Bulbs with 3-1/8" Light Center length as follows:

Fig. No.	Base Design	Wattage	Mfg. No.
340-19	Medium Screw	100	100A/CL A-19
532-1	Mogul Screw	50	P25/28
532-2	Mogul Screw	100	P25/29

#### SPARE PARTS

112½° Lenses, See Fig. 259, Nos. 1 or 2  
135° Lenses, See Fig. 269, Nos. 1 or 2  
225° Lenses, See Fig. 256, Nos. 1 or 2  
360° Lenses, See Fig. 261, Nos. 1 or 2  
Medium Screw Adapters, See Fig. 288

Mogul Adapters, See Fig. 1082  
Medium Screw Sockets, See Fig. 346 No. 2  
Mogul Sockets, See Fig. 270  
Mounting Brackets, See Fig. 143

**\*EMERGENCY OIL NAVIGATION LIGHTS FOR VESSELS OVER 65 FEET LONG  
Turret Top — Bottom Opening**

Size No.	Galvanized Steel Each	Plain Brass Each	Polished Brass Each	Nominal Height Lens Inches	Nominal Height Light Inches	Nominal Weight Pounds
1				6-3/4	15	7
2				7-1/2	18	10-1/2

**Recommended For Vessels 20 Meters to 50 Meters  
(65.7 ft. to 164.1 ft.)**



**Red & Green Side Lights  
112½ Degrees**



**Masthead Lights  
225 Degrees**



**Stem or Towing Lights  
135 Degrees**



**All-Round Lights  
360 Degrees**

Fig. No.	Description	Visibility Arc
21-R01	Red Side Light	112½°
21-G01	Green Side Light	112½°
982-001	White Masthead Light	225°
982-R01	Red Masthead Light	225°
982-M01	Yellow Masthead Light	225°
985-001	White Stern Light	135°
985-R01	Red Stern Light	135°
985-M01	Yellow Stern Light	135°
23-001	White All-Round Light	360°
129-R01	Red All-Round Light	360°
129-G01	Green All-Round Light	360°
129-M01	Yellow All-Round Light	360°

**Recommended For Vessels Over 50 Meters  
(164.1 ft.)**

Fig. No.	Description	Visibility Arc
21-R02	Red Side Light	112½°
21-G02	Green Side Light	112½°
982-002	White Masthead Light	225°
982-R02	Red Masthead Light	225°
982-M02	Yellow Masthead Light	225°
985-002	White Stern Light	135°
985-R02	Red Stern Light	135°
985-M02	Yellow Stern Light	135°
23-002	White All-Round Light	360°
129-R02	Red All-Round Light	360°
129-G02	Green All-Round Light	360°
129-M02	Yellow All-Round Light	360°

**\*NOTE: The Above Lights Are Offered For  
Emergency Use Only and may be Used on Vessels,  
Regardless of Construction Date.**

**SPARE PARTS**

- 112½° Lenses, See Fig. 259, Nos. 1 or 2
- 135° Lenses, See Fig. 269, Nos. 1 or 2
- 225° Lenses, See Fig. 256, Nos. 1 or 2
- 360° Lenses, See Fig. 261, Nos. 1 or 2
- Chimneys — See Fig. 267
- Burners — See Fig. 242
- Wicks — See Fig. 302 No. 2
- Oil Founts — See Fig. 282
- Mounting Brackets, See Fig. 143

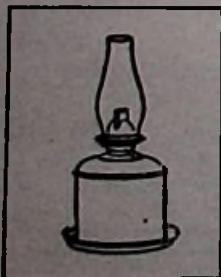

**Oil Lamp in Base of Light**

## FIXED SIGNAL LIGHTS — Fig. 403

THESE LIGHTS CAN BE USED ON VESSELS OVER 65 ft. LONG THE KEELS OF WHICH WERE LAID PRIOR TO JULY 15, 1977. FOR DETAILED INFORMATION CONSULT "RULES OF THE ROAD," C.G. 169 · INLAND SECTION, C.G. 172 · GREAT LAKES, C.G. 184 · WESTERN RIVERS, OR CONTACT YOUR LOCAL COAST GUARD OFFICE.

Cast Bronze — 32 Point — 360 Degrees

Fresnel Lens — Mogul Screw Socket

This Light is Often used for Blinker Signaling.

Size No.	Each	Height Lens Inches	Height Overall Inches	I.P.S. Thread Inches	Weight Pounds
2		4-1/4	9	3/4	6-1/2
3		6-3/4	11-1/2	1	9-1/2

Clear Fig. 403-C  
 Red Fig. 403-RC  
 Green Fig. 403-GC  
 Amber Fig. 403-MC



Fig. 403

Spare Lenses, See Fig. 261, Senior or No. 1

Spare Mogul Sockets, Fig. 270.

Spare Cover Gasket for Fig. 403 No. 2, Specify Fig. 1140 Size 1.

Spare Cover Gasket for Fig. 403 No. 3, Specify Fig. 1140 Size 2.



## VAPOR-PROOF FIXTURES

Listed by Underwriters Laboratories

Combination Junction Box — Ceiling and Bulkhead Type  
 7" Cast Guards — Screw Glass Globes — Clear — Keyless —  
 Die Cast Aluminum — Non Corrosive — Satin Finish.



Fig. 1087

CAPACITY UP TO 100 WATTS

Fig.	Each	Diameter Box Inches	Length Overall Inches	Weight Pounds
1087		3-3/4	9-1/2	3
1090		3-3/4	10	3-1/4

FIG. 1090 EXTENDS FROM BULKHEAD 7 INCHES OVERALL

Spare Guards, Specify Fig. No. and 99-A  
 Spare Sockets, Specify Fig. No. and 99-B  
 Spare Clear Globes, Specify Fig. No. and 99-C

Above fixtures have four 1/2 inch I.P.S. tappings.



Fig. 1090

## SPARE PARTS FOR SECTION B



### 112 1/2° LENSES

No.	Each	A Inches	B Inches
1		6-3/4	6-1/8
2		7-1/2	9-1/4

Red - Fig. 259-R  
Green - Fig. 259-G

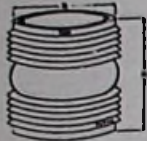

### 360° LENSES

No.	Each	A Inches	B Inches
1		6-3/4	5-1/8
2		7-1/2	7-3/8

White - Fig. 261  
Red - Fig. 261-R  
Green - Fig. 261-G  
Yellow - Fig. 261-M



### 225° LENSES

No.	Each	A Inches	B Inches
1		6-3/4	5-1/8
2		7-1/2	7-1/4

White - Fig. 256  
Red - Fig. 256-R  
Yellow - Fig. 256-M

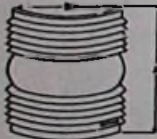

### 135° LENSES

No.	Each	A Inches	B Inches
1		6-3/4	4-1/2
2		7-1/2	6-5/8

White - Fig. 269  
Red - Fig. 269-R  
Yellow - Fig. 269-M



### MEDIUM SCREW SOCKETS

Phenolic - 250 Volts - 660 Watts

No.	Each	Thread Inches	Height Inches	Weight Ounces
1		1/8	1-7/8	1-1/4
2		3/8	1-7/8	1-1/4

Fig. 346

Standard Package - 5 Pieces



### MEDIUM SCREW SOCKETS

Phenolic - 600 Volts - 660 Watts

Each	Overall Height Inches	Overall Diameter Inches	Weight Ounces
	1-3/4	2-3/4	3

Fig. 369

Standard Package - 5 Pieces



### MOGUL 3 WIRE SOCKETS

Phenolic - 600 Volts - 1500 Watts  
With Metal Mounting Cap

Each	Thread Inches	Height Inches	Weight Ounces
	3/8	2-3/4	6-1/2

Fig. 270

Standard Package - 5 Pieces



Fig. 341

### SOCKET SUPPORTS

Brass - 3/8" I.P.S. Thread

No.	Each	Height Overall Inches	For Size Light	For Type Socket
1		1	1	Mogul
1-1/2		1-1/2	1	Medium
2		1-13/16	2	Mogul
3		2-1/4	2	Medium



Fig. 143

### MOUNTING BRACKETS

For Side Lights

Cast Aluminium

Each	Width Bracket Inches	Width Overall Inches	Weight Ounces
	2-1/2	5-1/2	8



Fig. 288

### ELECTRIC ADAPTERS

2 Wire Brass Medium Screw Socket

For Light No.	Each	Opening In Light Inches	Weight Ounces
1		3-3/4	6-1/2
2		4-3/4	8



Fig. 1082

### ELECTRIC ADAPTERS

3 Wire Mogul Socket

For Light No.	Each	Opening In Light Inches	Weight Ounces
1		3-3/4	11-1/2
2		4-3/4	13



Fig. 282

### OIL FOUNTS

Brass

For Light No.	Each	Opening In Light Inches	Weight Ounces
1		3-3/4	8
2		4-3/4	11



Fig. 242

### HINGED OIL BURNERS

Brass

Brass Each	Chrome Each	Diam. Thread Inches	Width Wick Inches
		1-1/4	7/8

Standard Package - 10 Pieces

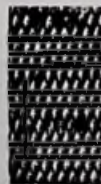

Fig. 302

### FLAT WICKS

Cotton - 7/8" Wide

No.	Each	Standard Package
2		10

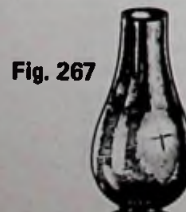

Fig. 267

### LIP CHIMNEYS

Glass

Each	Height Inches	Diam. Bottom Inches	Weight Ounces
	6	2-1/16	3

Standard Package - 10 Pieces

# SECTION C

# PERKO®

**SWITCHES, PANELS,  
CONNECTORS, ETC.**

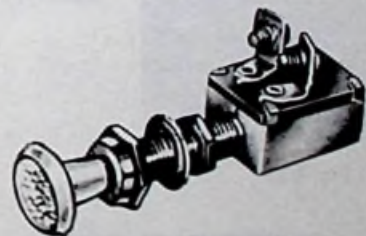
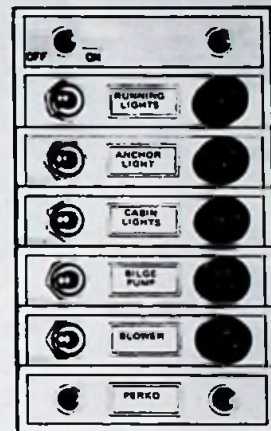

MANUFACTURED BY PERKO, INC., 16490 N.W. 13TH AVE., P.O. BOX 64000-D, MIAMI, FLORIDA 33164

FOR COMPLETE LINE SEE CATALOG NO. 230

© PERKO, INC.  
ALL RIGHTS RESERVED

PORTIONS OF THIS CATALOG PREVIOUSLY  
COPYRIGHTED IN 1936 THRU 1976 INCLUSIVE



**Fig. 85**  
for 2 or more batteries



**Fig. 96**  
for a single battery



**Fig. 85-SP**

**IMPROVED SAFETY MAIN SWITCHES — Figs. 85 & 96**  
Red Plastic Housing — Vapor Tight — Copper Contacts  
Brass Terminals — Stainless Steel Spring.  
Improved Feature Allows Use With Alternators or Generators  
Since It Is A Make-Before-Break Design.

Rated at 210 amperes continuous, 315 amperes intermittent.  
(6, 12, and 32 volts)  
Can be installed flush or offset. Supplied with complete set  
of 4 offset mounting legs.

Tested and accepted for labeling and listing by the  
Underwriters Laboratories, Inc.

Each	Diameter Inches	Depth Inches	Weight Ounces
	5	1-3/4	10

Spare Offset Mounting Legs (Set of 4) Specify Fig. 103

**SKIN PACK — Fig. 85-SP**  
One Switch Per Card.  
Three Cards Per Box.  
Weight Per Box 4 Pounds.

Sold To Trade In Full Box Only.

**SWITCH PANEL — Fig. 517**

Black Textured Finish — Embossed Lettering  
Complete With Switches, Fuse Holders, and Name Plates.  
This Improved Panel is Now Moulded From A Durable Plastic  
That Will Not Crack Or Split But Is Flexible Enough To  
Mount on Curved As Well As Flat Surfaces.

Illustration shows stock panel. Dealer or user may change  
name plates, see Fig. 519 for additional selection. Changes  
can be made at factory for additional cost. See footnote.

Each	Size Inches	Weight Ounces
	6-1/2x4-1/4	8

Spare Switches, Specify Fig. 514.

Spare Fuse Holders, Specify Fig. 516.

Spare Cap Only for Fuse Holders, Specify Fig. 522.

Note, If Name Plates Other Than Shown Are Desired Specify Fig.  
517A And Names Required.

**SWITCH NAME PLATES—Fig. 519**

Black With Engraved White Lettering



**Fig. 517**

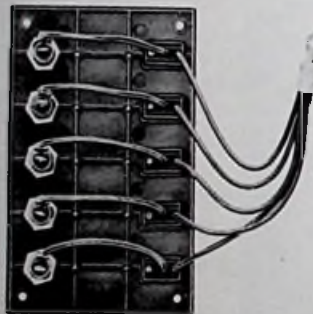

**BACK VIEW OF  
IMPROVED PANEL**



**Fig. 519**

No.	No.	No.	No.
1 Anchor Light	12 Engine Room	24 Misc.	37 Spreader Light
2 Anchor Winch	13 Fan	25 Neutral	38 Stbd. Light
3 Bilge Pump	14 Flood Lights	26 Off	39 Starter
4 Blower	15 Forward	27 On	40 Stern Light
5 Bow Light	16 Fuel	28 Outdrive Tilt	41 Throttle
6 Cabin Lights	17 Fuel Pump	29 Panel Lights	43 Water System
7 Choke	18 Heater	31 Port Light	44 Wiper
8 Compass	19 Horn	32 Radio	45 12 Volt
9 Deck Lights	20 Ignition	34 Reverse	46 32 Volt
10 Docking Light	21 Lights	35 Running Lights	47 110V AC
11 Dome Lights	23 Masthead Light	36 Searchlight	48 110V DC

Each	Length Inches	Width Inches	Screw Size No.	Weight Per Dozen Ounces
	1-1/2	1/2	4	1/2

Standard package, 5 pieces each name.  
Minimum Quantity, Stock Names, 5 Pieces.  
Special name plates, Minimum quantity  
20 pieces each name.



## MODULAR SWITCH PANELS

CHROMIUM PLATED

Turquoise Lettering – Aluminum Matte Background – Self-Adhesive Name Plates

Toggle Switches – Bakelite Fuse Holders for Glass Fuses.

Add to or remove sections as desired, size of panel and quantity of switches regulated only by the space available.

### ASSEMBLED 5 POSITION PANEL—Fig. 512

This is a stock panel but section "B" may be added or names changed by dealer or owner. See selection of name plates below.

Each	Dimensions Inches	Weight Ounces
	6-1/4x3-3/4	16

Note – This panel assembled with one section "A". Four section "B". One section "C".

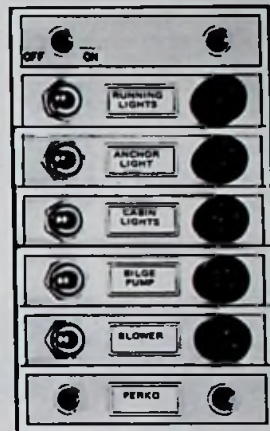

Fig. 512

### MODULAR SECTIONS – Fig. 511

To be purchased individually and assembled by owner to meet requirements.

#### SECTION "A"

As illustrated, consists of top mounting panel, one switch, one fuse holder, no name.

Each	Dimensions Inches	Weight Ounces
	1-3/4x3-3/4	3-1/2

#### SECTION "B"

Consists of one switch, one fuse holder, no name.

Each	*Dimensions Inches	Weight Ounces
	7/8x3-3/4	2-1/2

#### SECTION "C"

Consists of bottom mounting panel.

Each	*Dimensions Inches	Weight Ounces
	1x3-3/4	2-1/4

\*Does not include assembly eyes. Standard Package – 5 pieces.

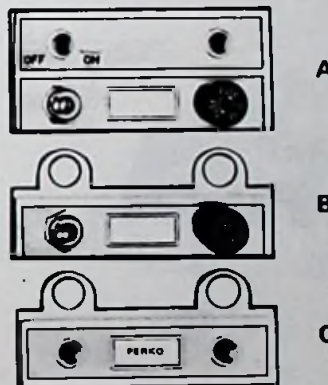

Fig. 511

### ALUMINUM NAME PLATES – Fig. 490

Turquoise lettering - self adhesive. For all above panels and frames.

#### NAME SELECTION AVAILABLE (NO SPECIALS)

No.	No.	No.
1 Anchor Light	6 Dome Light	11 Radio
2 Bilge Pump	7 Fuel	12 Running Lights
3 Blower	8 Horn	13 Spreader Light
4 Cabin Lights	9 Masthead Light	14 Starter
5 Compass	10 Misc.	15 Wiper

Each	Dimensions Inches
	15/16 x 3/8



Fig. 490

Standard package – 5 Pieces – Minimum quantity.

Spare Switches – Specify Fig. 514.

Spare Fuse Holders – Specify Fig. 516.

Spare Cap Only for Fuse Holders – Specify Fig. 522.

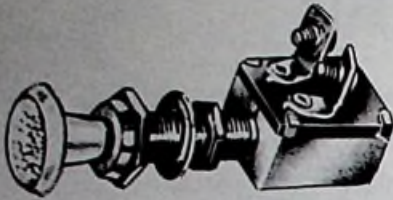

Fig. 105

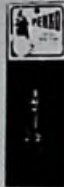

Fig. 105 SP

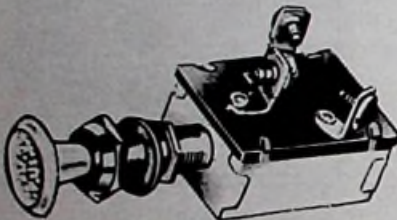

Fig. 321

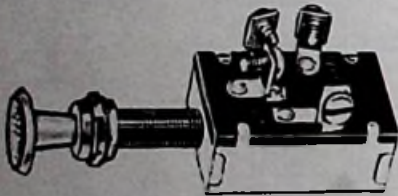

Fig. 366

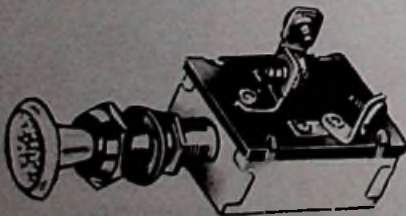

Fig. 381



Fig. 387

**PUSH AND PULL SWITCHES—Fig. 105**

All Brass — 2 Terminal — OFF-ON — 25 Amps. at 12 Volts

No.	Chromium Plated Each	Diam. Neck Inches	For Wood Thickness Inches	Length Overall Inches	Diam. Knob Inches	Weight Ounces
1		3/8	1	3	3/4	2
2		3/8	1-1/4	3-1/4	3/4	2-1/2

Standard package 10 pieces.



**SKIN PACK FIG. 105-SP**

No. 1

One Switch Per Card.

Twelve Cards Per Box.

Weight Per Box 3 Pounds.

Sold to trade in full box only.



**PUSH-PULL SWITCH—Fig. 321**

All Brass — 3 Terminal — OFF-ON-ON — 25 Amps. at 12 Volts

First "On" Position Energizes One Circuit.

Second "On" Position Energizes Other Circuit.

Ideal for Anchor Light on separate circuit from Running Lights, all on one switch.

Chromium Plated Each	Diam. Neck Inches	Diam. Knob Inches	For Wood Thickness Inches	Weight Ounces
	3/8	3/4	1	3-1/4

Standard package 10 pieces.



**3-POSITION PUSH-PULL SWITCH—Fig. 366**

All Brass — 2 Circuit — OFF-ON-ON — 25 Amps. at 12 Volts

For use with combination bow and anchor lights. First position is off; second position for side, stern and bow lights; third position is for anchor light . . . illuminates both compartments of bow-anchor light.

Chromium Plated Each	Diam. Neck Inches	Diam. Knob Inches	For Wood Thickness Inches	Weight Ounces
	3/8	3/4	1	3-1/4

Standard package 10 pieces.



**3-POSITION PUSH-PULL SWITCH—Fig. 381**

All Brass — 3 Terminal — 3/4 Inch Chromium Plated Knob

3 Position Switch — OFF-ON-ON — 25 Amps. at 12 Volts

First "on" position energizes one circuit. Second "on" position energizes all circuits.

Chromium Plated Each	Diam. Neck Inches	For Wood Thickness Inches	Length Overall Inches	Weight Ounces
	3/8	1	3-3/4	3

Standard package 10 pieces.



**MOISTURE PROOF**

**BOOT AND NUT ASSEMBLY—Fig. 387**

For Lock Type Switches

Key enters thru elastic slot in rubber boot.

The nut fits Figs. 304, 310 and 316 No. 2

Each

Standard Package, 5 Pieces.

NOTE—Spare Plastic, Chromium Plated knobs for above Push-Pull switches, Specify Fig. 104.

**BUY STANDARD PACKAGES**

**MOMENTARY STARTER SWITCH  
OR DASHBOARD HORN BUTTON—Fig. 255**

All Brass — Push Button Type — 2 Point, 2 Terminal Spring  
Action — Chromium Plated Button — 25 Amp. at 12 Volts.

Each	Diameter Neck Inches	For Wood Thickness Inches	Weight Ounces
	5/8	1	2-1/2

Standard Package, 10 Pieces

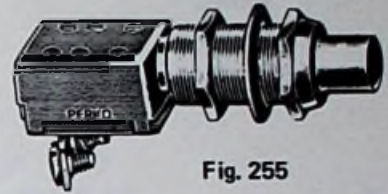

Fig. 255

★  
**SKIN PACK FIG. 255 SP**

One Switch Per Card.  
Six Cards Per Box.  
Weight Per Box 3 Pounds.

Sold to trade in full box only.



Fig. 255 SP

★  
**WATERPROOF**

**MOMENTARY STARTER SWITCH  
OR DASHBOARD HORN BUTTON—Fig. 306**

All Brass — Push Button Type — 2 Point, 2 Terminal Spring  
Action — Neoprene Cover Over Button — 25 Amps. at 12 Volts

Each	Diameter Neck Inches	For Wood Thickness Inches	Weight Ounces
	5/8	1	2-1/2

Standard Package, 10 Pieces

Spare covers with Nut. Specify Fig. 306-99A.



Fig. 306

★  
**IGNITION LOCK SWITCH—Fig. 316**

Face Plate Chromium Plated — 2 Terminal — 2 Keys  
20 Amps. at 12 Volts — Off-On.

No. 1 Die Cast Zinc Housing  
No. 2 All Brass

No.	Each	Diameter Neck Inches	Length Neck Inches	Weight Ounces
1		3/4	5/8	4
2		13/16	1	4-1/2

Standard Package, 10 Pieces

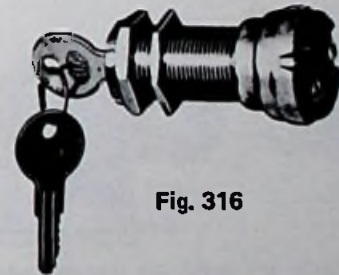

Fig. 316

★  
**SKIN PACK FIG. 316 SP**

SIZE NO. 1  
One Switch Per Card.  
Six Cards Per Box.  
Weight Per Box 2 Pounds.

Sold to trade in full box only.



Fig. 316 SP

★  
**IGNITION-STARTER SWITCH—Fig. 310**

All Brass — Lock Type — 3 Terminal — 2 Keys — 3 Position  
Switch, OFF-IGNITION-START — 20 Amps. at 12 Volts.

Returns automatically from start to ignition position.  
Face nut is chromium plated, springs are stainless steel.

Each	Diameter Neck Inches	Length Neck Inches	Weight Ounces
	13/16	1-1/16	4-1/2

Standard Package, 10 Pieces

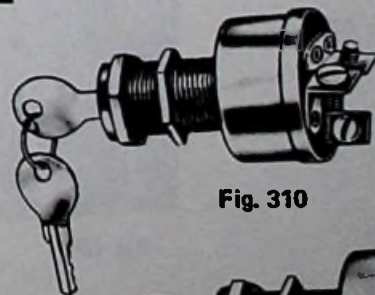

Fig. 310

★  
**MAGNETO IGNITION STARTER SWITCH—Fig. 304**

All Brass — 5 Terminals — 2 Keys — 20 Amps. at 12 Volts  
3 Positions, OFF-RUNNING-START

Face Nut Chromium Plated, Stainless Steel Springs

Each	Diameter Neck Inches	Length Neck Inches	Weight Ounces
	13/16	1-1/4	8

Standard package, 5 Pieces.

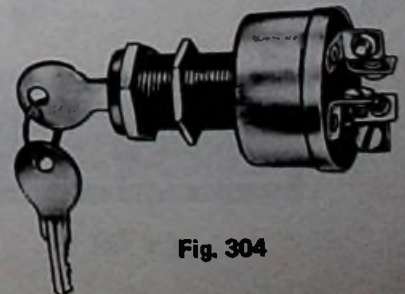

Fig. 304



Fig. 703

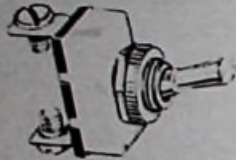

Fig. 688

Fig. 703 SP



Fig. 745

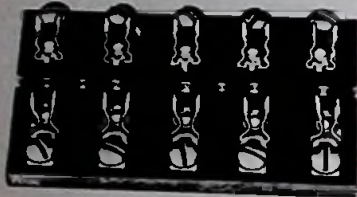

Fig. 626

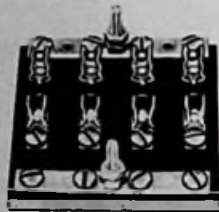

Fig. 647



Fig. 629



Fig. 694



Fig. 627

### PUSH TYPE SWITCH FIG. 703

Non Magnetic – With 6 Inch Wire Leads

Each	Length Neck Inches	Diameter Neck Inches	Between Lock Nuts Inches	Weight Ounces
	3/8	3/8	1/8	1/2

Standard package 10 pieces.

### SKIN PACK FIG. 703 SP

One Switch Per Card.

Six Cards Per Box.

Weight Per Box 9 Ounces

Sold in trade in full box only.

### TOGGLE SWITCHES—Fig. 688 AND 745

Fig. 688 – Brass – Screw Posts – No Leads – 15 Amp.

Fig. 745 – Brass with Bakelite Insulation

With 6 Inch Wire Leads – 20 Amp.

	Nickel Plated Each	Length Neck Inches	Diam. Neck Inches	Max. Thickness of Panel Inches	Weight Ounces
Fig. 688–		3/8	7/16	3/16	1
Fig. 745–		7/16	7/16	5/16	3/4

Standard package 10 pieces.

### FUSE PANELS—Fig. 626

Molded Plastic Base – Brass Parts – For 20 Amp. Glass Fuses

Number of Gangs	Each	Dimensions Inches	Weight Ounces
3		2-1/4x2-7/16x3/16	2
4		3 x2-7/16x3/16	2-1/4
5		3-3/4x2-7/16x3/16	2-1/2
6		4-1/2x2-7/16x3/16	2-3/4

Standard package 5 pieces

### COMBINATION FUSE AND TERMINAL BLOCK—Fig. 647

With Heavy Duty Binding Posts – Molded Plastic Base – Brass Parts – For 20 Amp. Glass Fuses

Number Of Gangs	Each	Dimensions Inches	Weight Ounces	Standard Package
4	3	x3-5/16x3/16	3-1/2	5
6	4-1/2	x3-5/16x3/16	5	5
8	6	x3-5/16x3/16	7	1
12	9	x3-5/16x3/16	11	1

### FUSE PANELS—Fig. 629

With Single Buss Bar – Molded Plastic Base – Brass Parts – For 20 Amp. Glass Fuses

Number Of Gangs	Each	Dimensions Inches	Weight Ounces	Standard Package
4	3	x2-7/16x3/16	2	5
6	4-1/2	x2-7/16x3/16	3	5
8	6	x2-7/16x3/16	4	1
12	9	x2-7/16x3/16	6-1/2	1

### FUSE PANEL—Fig. 694

Molded Plastic – Brass Metal Parts – For Glass Fuses up to 30 Amp

For two active fuses and one spare.

Each	Dimensions Inches	Length Fuse Inches	Weight Ounces
	2-7/16x1-1/2x3/16	1-1/4	1-1/2

Standard package 5 pieces.

### TERMINAL BLOCKS—Fig. 627

Molded Plastic Base – Brass Parts

Number of Gangs	Each	Dimensions Inches	Weight Ounces
2		1-1/2x1-1/2x3/16	1-3/4
4		3 x1-1/2x3/16	2
6		4-1/2x1-1/2x3/16	2-1/4

Standard package 5 pieces.

## PLASTIC CABLE STRAPS—Fig. 196

Made of pliable butyrate in clear color and ultra-violet stabilized for weather resistance, this new strap eliminates the need for insulating cushion and provides excellent cable support at low cost. Single screw saves labor and fastenings. Width for all cable sizes 1/2" I.D. of fastening hole 3/16".

No.	Cable Diameter Inches	Per 100	No.	Cable Diameter Inches	Per 100
1	3/16		5	1/2	
2	1/4		6	5/8	
3	5/16		7	3/4	
4	3/8				

Standard package 100 pieces per size Minimum Quantity.



Fig. 196

## BRASS CABLE STRAPS—Fig. 121

For Cable, Tubing, Control Wire, Etc.

No.	Inside Diam. Inches	Per 100	Length Inches	Width Inches	No.	Inside Diam. Inches	Per 100	Length Inches	Width Inches
1	1/8		1-7/16	1/2	6	7/16		1-5/8	1/2
2	3/16		1-3/8	1/2	7	1/2		1-1/2	1/2
3	1/4		1-5/16	1/2	8	5/8		1-3/4	1/2
4	5/16		1-3/16	1/2	9	3/4		1-7/8	1/2
5	3/8		1-5/8	1/2					

Standard package 100 pieces per size Minimum Quantity.



Fig. 121

## LINE SUPPORT CLIPS—Figs. 163, 164 & 165

Aluminum — Synthetic Rubber Cushion

No.	For O.D. Line Inches	FIG. 163 Per 100	FIG. 164 Per 100	FIG. 165 Per 100	Width Inches
1	3/16			*N.A.	3/8
2	1/4			N.A.	3/8
3	5/16				1/2
4	3/8				1/2
5	1/2				1/2
6	5/8		*N.A.	N.A.	1/2

\*NOT AVAILABLE

Standard package 100 pieces per size Minimum Quantity.



Fig. 163  
Single



Fig. 164  
Double



Fig. 165  
Triple

BE SURE TO SPECIFY SIZE

## BAYONET SOCKETS—Fig. 472

Phenolic — Single and Double Contact

No.	Each	Type	Height Inches	Diam. Base Inches	Weight Dozen Ounces
20		Double contact	1	1-3/8	9
21		Single contact	1	1-3/8	9

Standard package 10 pieces.



Fig. 472

## ELECTRIC SOCKET ADAPTERS—Fig. 405

For Converting Various Types of Sockets

No.	Each
-----	------

- 1—From Bayonet Dble. Contact to Med. Screw . . . . .
  - 2—From Med. Screw to Bayonet Dble. Contact . . . . .
  - 3—From Mogul to Medium Screw . . . . .
- Illustration is type No. 2.

Standard package 5 pieces.



Fig. 405

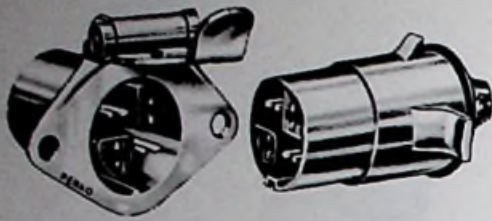

Fig. 739

**4-WAY CONNECTOR FOR TRAILER LIGHTS—Fig. 739**  
**CHROMIUM PLATED**  
 Snap Cover on Receptacle, Locks Plug in and Keeps Moisture Out.  
 Fixed Polarity — Screw Terminals.

Each	Length Overall Inches	Width Flange Inches	Weight Ounces
	3-3/4	2-1/8	4-1/2



Fig. 751

**4-PRONG CONNECTOR FOR TRAILER LIGHTS - Fig. 751**

Plastic Body — Soft Plastic Caps — Screw Terminals  
 Fixed Polarity — All Brass

Each	Size Inches	Weight Ounces
	1 x 2 3/4	1

Standard package 10 pieces.

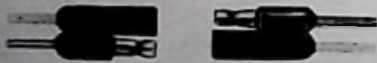

Fig. 720-2

**MOLDED LINE CONNECTORS—Fig. 720**

Waterproof Bodies — Color Coded Wires

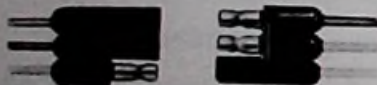

Fig. 720-3

Polarized for proper mating of circuits. Conductors precision aligned and molded in S.A.E. Type P.V.C. insulation for minimum voltage drop and ease in making and breaking connections.

12 inch long wires on male and female sides.

Poles	Each	Width Inches	Weight Ounces
2		5/8	1/2
3		7/8	1
4		1-1/8	1-1/2

Standard package 5 pieces.



Fig. 720-4—Shrouded

**SKIN PACK, FIG. 720 SP, 2, 3 or 4 Poles.**



Fig. 720 SP

One Connector Per Card.  
 Five Cards Per Box.  
 Weight Per Box, Average 9 Ounces.  
 Sold to trade in full box only.

## WATERTIGHT DECK CONNECTIONS—Fig. 1189

Brass with Black Plastic Covers — Double Contact — Chromium Plated

The covers snap on or off for quick connection.  
The connector is brass, well insulated.

Each	Diameter Inches	Height Inches	Weight Ounces
	1-5/8	1-3/16	2

Standard Package, 10 Pieces  
Spare Parts, See Fig. 1190



## WATERTIGHT DECK CONNECTION—Fig. 1190

Die Cast Zinc Alloy with Plastic Covers — Double Contact — Chromium Plated

Same as above Fig. 1189 in every detail except metal flange is Die Cast Zinc Alloy.

Each

Standard Package, 10 Pieces

Spare Connectors for Figs. 1189 and 1190, Specify Fig. 42

Spare Covers for male plugs, Specify Fig. 1145

Spare Covers for female socket, Specify Fig. 1147

Standard Package, Spares, 5 Pieces



## SKIN PACK — FIG. 1190-SP

One Connection Per Card.

Five Cards Per Box.

Weight Per Box, 14 Ounces.

Sold to Trade in Full Box Only



## WATERTIGHT CABLE OUTLETS—Figs. 424 & 1191

All Brass or Die Cast Zinc Alloy — Chromium Plated

Has rubber grommet for watertight passage of cable through deck or bulkhead, also prevents chafing of cable insulation.

Fig. 424 Each	Fig. 1191 Each	Diameter Base Inches	For Cable Inches	Weight Ounces
		1-1/4	5/16	1

Standard Package, 10 Pieces

Spare Rubber Grommets, Specify Fig. 1149



## FUSED LINE CONNECTOR — Fig. 786

Molded Bakelite — With 20 AMP. Fuse and Wire Leads

For Standard Glass Fuses 1-1/4 Inches Long.

Each	Length Inches	Diameter Inches	Weight Ounces
	2-1/8	5/8	3/4

Standard Package, 10 Pieces



## SKIN PACK— FIG. 786-SP

One Connector Per Card.

Ten Cards Per Box.

Weight Per Box, 3/4 Pound.

Sold to Trade in Full Box Only



## HORN PUSH BUTTON — Fig. 275

Brass — Chromium Plated — Bakelite Button and Interior  
10 Amps. at 12 Volts

Chromium Plated Each	Length Overall Inches	C. to C. Holes Inches	Diam. Inches	Weight Ounces
	2-5/8	2-1/8	1-1/2	1

Standard Package, 10 Pieces



Fig. 1189



Fig. 1190



Fig. 1190-SP

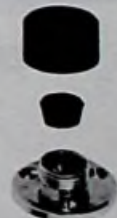

Fig. 424 — All Brass  
Fig. 1191 — Die Cast



Fig. 786



Fig. 786-SP



Fig. 275



Fig. 134

**INDICATOR LIGHT—Fig. 134  
WITH DIMMER FOR NIGHT RUNNING**

Black Anodized Aluminum Bezel  
Chromium Plated Facing Washer — Red Lens  
Screw Terminals

To regulate the brightness of light simply rotate the Bezel

Each	Diameter Lens Inches	Max. Panel Thickness Inches	Diameter Bezel Inches	Weight Ounces
	1/2	3/8	13/16	1-1/2

Lamp Not Included — See Fig. 56 No. 5.  
Standard Package, 10 Pieces



Fig. 135

**INDICATOR LIGHT—Fig. 135  
WITHOUT DIMMER**

Polished Chromium Plated Brass Bezel  
Chromium Plated Facing Washer — Clear Lens  
Screw Terminals

Each	Diameter Lens Inches	Max. Panel Thickness Inches	Diameter Bezel Inches	Weight Ounces
	3/4	1/2	7/8	1-1/2

Lamp Not Included — See Fig. 56 No. 5.  
Standard Package, 10 Pieces

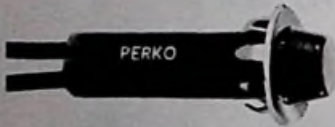

Fig. 136



Fig. 137

**"GLO-LITE" INDICATOR LIGHTS—Figs. 136 & 137  
With 12 Volt Bulb — Red Color**

Fig. 136 for snap in mounting in thin panels.  
Fig. 137 with Tinnerman nut for mounting in thick panels.

Fig.	Each	Diameter Lens Inches	For Diameter Hole Inches	Overall Length Inches	Weight Ounces
136		3/8	3/8	1-5/8	1/2
137		7/16	1/2	1-3/8	1/2

Standard Package, 10 Pieces



Fig. 139

**INSTRUMENT PANEL LIGHT—Fig. 139  
Non Corrosive — Waterproof — Chromium Plated  
An excellent shielded light for instruments or charts.**

Each	Diameter Shield Inches	Diameter Bezel Inches	Max. Panel Thickness Inches	Weight Ounces
	1/2	3/4	3/8	3/4

Lamp Not Included — See Fig. 56 No. 5.  
Standard Package, 10 Pieces



Fig. 184

**DASHBOARD LAMP — Fig. 184  
Brass — Chromium Plated — Double Contact Socket With  
Switch — For 6 C.P. Bulb**

Bulb is not included.

Each	Length Overall Inches	Size Base Inches	Weight Ounces
	2-1/2	1-11/16 x 1-3/16	1-3/4

Standard Package, 10 Pieces



## ELECTRIC LIGHTING LAMPS

### BAYONET D.C. BASE – FIG. 337

Item No.	Mfr. Lamp No.	Volts	C.P.	Bulb Diam. Inches	Clear Each
4	82	6	6	3/4	
11	90	12	6	3/4	
12	1004	12	15	3/4	
13	1142	12	21	1	
14	1144	12	32	1 3/8	
18	624	32	9	3/4	
19	1228	32	15	1	
20	1692	32	21	1	
21	1054	32	32	1 3/8	
23	15T7	120	15W	7/8	

Standard Package, No. 4 to 21 Inc. 10 Pieces  
No. 23, 6 Pieces



### MINIATURE BAYONET BASE – FIG. 56

Item No.	Mfr. Lamp No.	Volts	C.P.	Bulb Diam. Inches	Clear Each
4	1416	12	8	13/32	
5	1815	14	1.4	7/16	
6	1495	32	9	9/16	

Standard Package, 10 Pieces  
No. 4 Available in Skin Pack, See Skin Pack Section.



### DOUBLE ENDED BASE – FIG. 70

Item No.	Mfr. Lamp No.	Volts	C.P.	Bulb Diam. Inches	Clear Each
0	212-2	12	6	9/16	
1	211-2	12	12	9/16	
2	10126	32	12	9/16	

Standard Package, 10 Pieces  
No. 1 Available in Skin Pack, See Skin Pack Section.



### MEDIUM SCREW BASE – FIG. 340

Item No.	Mfr. Lamp No.	Volts	Watts	Type	L.C.L. Inches	Clear Each	Frosted Each
5	15-A	12	15	A-17	2-3/8	* N.A.	
6	25-A	12	25	A-19	2-9/16	N.A.	
7	50-A21	12	50	A-21	3-7/16	N.A.	
11	15-A	32	15	A-17	2-3/8	N.A.	
12	25-A	32	25	A-19	2-9/16	N.A.	
13	50-A21	32	50	A-21	3-7/16	N.A.	
17	60A/CL	120	60	A-19	3-1/8	*N.A.	
19	100A/CL	120	100	A-19	3-1/8	N.A.	

Standard Package—No. 5 to 11 Inc. 6 Pieces  
Nos. 12 to 19 Inc. 2 Pieces

\* Not Available



### MOGUL SCREW BASE – FIG. 532

Item No.	Mfr. Lamp No.	Volts	Watts	L.C.L. Inches	Clear Each
1	P25/28	120	50-50	3 3/4	
2	P25/29	120	100-100	3 3/4	

Standard Package, 1 Piece

#### NOTES

High Power Lamps For Searchlights And Sealed Beam Units, See Section E.

ELECTRIC LAMPS ARE NOT RETURNABLE. ORDER CAREFULLY.

ALL ILLUSTRATIONS  
SHOW ACTUAL SIZE OF BASE



Fig. 337



Fig. 56



Fig. 70



Fig. 340

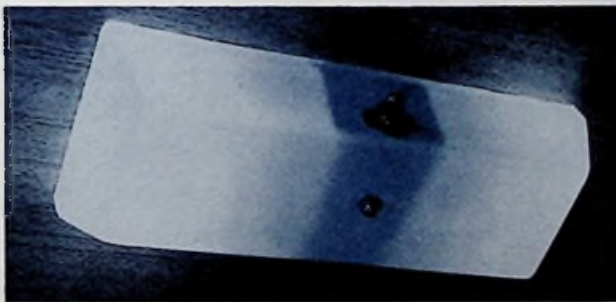

Fig. 532



# PERKO®

## Lighting Fixtures



MANUFACTURED BY PERKO, INC., 16490 N.W. 13TH AVE., P.O. BOX 64000-D, MIAMI, FLORIDA 33164

FOR COMPLETE LINE SEE CATALOG NO. 230

PORTIONS OF THIS CATALOG PREVIOUSLY  
COPYRIGHTED IN 1936 THRU 1976 INCLUSIVE

## LIGHTING FIXTURES LOW VOLTAGE - 6 TO 32 INC.



Fig. 217



Fig. 1295

### BULKHEAD FIXTURES - Figs. 217 & 1295

Die Cast Zinc Alloy - Chromium Plated

Medium Screw Socket - Turn Switch

Fig. 1295 Has Power Take-Off Receptacle.

Fig.	Chromium Plated Each	Size Base Inches	Projection Inches	Weight Ounces
217		2-1/2x1-3/4	2-5/8	10
1295		2-1/2x1-3/4	2-5/8	10

Lamp Not Included.

Spare Sockets with Knob, Specify Fig. 223

Spare Power Take-Off Receptacle, Specify Fig. 225.



Fig. 217-SP

### SKIN PACK - Fig. 217-SP

One Fixture Per Card

Six Cards Per Box

Weight Per Box, 3 1/2 Pounds

Sold To Trade In Full Box Only.



Fig. 450

### BULKHEAD FIXTURE - Fig. 450

Cast Bronze

Medium Screw Socket - Turn Switch

Polished Bronze Each	Chromium Plated Each	Size Base Inches	Projection Less Lamp Inches	Weight Ounces
		2-1/2x2-1/4	2-1/2	8

Spare Socket with Knob, Specify Fig. 223.



For Hanging Bulb  
Fig. 27



For Upright Bulb  
Fig. 28

### MARINE SHIELDS FOR FIXTURES - Figs. 27 & 28

Translucent Plastic - Washable - Hand Laced to Brass Plated Frame - Painted or Plain

Colorful painted marine design makes these shields very decorative and appropriate for a yacht stateroom, cabin, club or marine room. Metal clip is for bulb up to 60 watts.

Painted Each	Plain Each	Width Inches	Height Inches	Weight Ounces
		4-1/2	4-5/8	1

Standard Package, 10 Pieces

### SHIELD DESIGNS - Figs. 33, 34, & 36

Same quality and construction as Figs. 27 and 28 above. Attractive two color marine designs suitable for hanging and upright bulb.

Painted Each	Width Inches	Height Inches	Weight Ounces
	4-1/2	4-5/8	1

Standard Package, 10 Pieces

### SKIN PACK - Figs. 33, 34 or 36-SP

One Shield Per Card

Six Cards Per Box

Weight Per Box, 2 Pounds

Sold To Trade In Full Box Only.



Fig. 33



Fig. 34



Fig. 36

## LIGHTING FIXTURES

FOR CABIN, STATEROOM OR BERTH – ADJUSTABLE ANGLE SHADE  
 LOW VOLTAGE 6 TO 32 INC.  
 ACRY-COLOR FINISH – PUSH TYPE SWITCH

No.	Dimensions Wall Plate Inches	Normal Projection Inches	Length Shade Inches	Weight Ounces
1	4-1/2 x 3-1/4	4-3/8	3	13
2	4-1/2 x 3-1/4	5	4-1/2	15



Fig. 1303 BK – Black  
 Fig. 1303 BR – Royal Bronze  
 Fig. 1303 GD – Gold  
 Fig. 1303 WH – White

Size No. 1 has Bayonet Double Contact Socket.  
 Size No. 2 has Medium Screw Socket.

Fig. 1303 Single Fixture has opaque shade same color as wall plate.

Each  
 Specify Size and Color



Fig. 1304 Double Fixture has two opaque shades and two switches. Shades same color as wall plate.

Each  
 Specify Size and Color

Fig. 1304 BK – Black  
 Fig. 1304 BR – Royal Bronze  
 Fig. 1304 GD – Gold  
 Fig. 1304 WH – White

Fig. 1350 Single Fixture has white translucent plastic shade and white wall plate.

Each  
 Specify Size



Fig. 1350

Spare Switches For Above, See Fig. 703.

Spare D.C. Sockets For No.1, Specify Fig. 276 No. 0

Spare Medium Screw Sockets For No.2, Specify Fig. 1323

### BULKHEAD OR CEILING FIXTURE – Fig. 1212

Die Cast Zinc Alloy – Chromium Plated – White Plastic Globe  
 Two D.C. Bayonet Sockets – Turn Switch

This fixture designed for arrangement in Modular Form.

Each	Length Inches	Width Inches	Depth Inches	Weight Ounces
	5-1/2	4-1/2	1-1/2	12

Spare Sockets, See Fig. 24 No. 1

Spare Switches, Specify Fig. 1212-99A

Spare White Plastic Globe, Specify Fig. 1212-99B



Fig. 1212



Fig. 308

**FLUSH TYPE DOME LIGHT—Fig. 308**

Die Cast Zinc Alloy — Chromium Plated

Double Contact Socket — Push Switch

No.	Chromium Plated Each	Diameter Glass Inches	Diameter Overall Inches	Depth Above Flange Inches	Depth Below Flange Inches	Weight Ounces
0		3	3-3/4	5/8	3/4	5
1		4	4-1/2	3/4	1-1/4	7
2		5	5-1/2	3/4	1-1/2	9

Spare Globes, Specify Fig. 308-99A and Size

Spare Switches, See Fig. 703

Spare Sockets, See Fig. 24 No. 1



Fig. 300

**DOME LIGHT— Fig. 300**

Die Cast Zinc Alloy — Chromium Plated

Double Contact Socket — Push Switch

No.	Chromium Plated Each	Diameter Globe Inches	Diameter Overall Inches	Depth Overall Inches	Weight Ounces
0		3	3-3/4	1-1/2	7
1		4	5-3/8	1-7/8	9
2		5	6-1/2	2	11

Spare Globes, Specify Fig. 257 and Size

Spare Switches, See Fig. 703

Spare Sockets, See Fig. 24, No. 1



Fig. 300-SP



**SKIN PACK — Fig. 300-SP**

Size No. 1 Only

One Light Per Card

Three Cards Per Box

Weight Per Box, 2½ pounds      Sold To Trade In Full Box Only



Fig. 555

**DOME LIGHT — Fig. 555**

Cast Bronze — Chromium Plated — Toggle Switch — Medium Screw Socket.

Will accommodate a 15-watt bulb. Fig. 340.

Each	Diam. Globe Inches	Diam. Base Inches	Depth Inches	Weight Pounds
	6	7-7/8	3-1/8	3-3/4

Spare Globe, Specify Fig. 257, 6 Inch

Spare Socket, Specify Fig. 346, No. 1

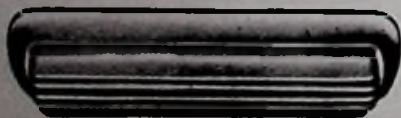

Fig. 761

**MODERN DESIGN DOME LIGHT—Fig. 761**

Bone White — Nylon Base and Globe —

With 12 Volt, 12 C.P. Fig. 70 Bulb

Each	Length Overall Inches	Width Overall Inches	Depth Overall Inches	Weight Ounces
	7	2-3/4	3/4	2



Fig. 318

**DOME LIGHT — Fig. 318**

White Translucent Plastic Globe — 18-8 Stainless Steel Base — Brass Sockets — 3 Position Toggle Switch.

Now supplied for ship and shore current. Complete with 2, 12 volt and 2, 110 volt bulbs. All Double contact bayonet type, controlled by a 3 position switch for dual voltage.

Each	Length Inches	Width Inches	Depth Inches	Weight Ounces
	9-3/4	3-3/4	1-7/8	14

Spare Switches, Specify Fig. 318-99A

Spare Sockets, See Fig. 276 No. 0

Spare Bulbs, See Fig. 337 Nos. 12 and 23

## DOME LIGHT – Fig. 753

Low Voltage – 6 to 32 Inc.

Wrought Brass – Toggle Switch

Nickel Plated Reflector – Medium Screw Socket

Will accommodate bulbs up to 50 watts.

No. 1 has one socket and switch.

No. 2 has two sockets and switches.

No.	Chromium Plated Each	Diameter Base Inches	Diameter Glass Inches	Depth Overall Inches	Weight Pounds
1		9-1/2	8	3	2
2		9-1/2	8	3	2-1/4

Spare Toggle Switch, Specify, Fig. 745

Spare Frosted Glass, Specify Fig. 132

Spare Socket, Specify Fig. 1323



Fig. 753

## WATERTIGHT DOME LIGHT – Fig. 1266

Cast Bronze – Double Contact Socket – Diffusing Globe

For small boats. Will accommodate up to a 21 C.P. bulb. With stainless steel reflector, toggle switch and one packing gland for cable.

Plain Bronze Each	Chromium Plated Each	Extreme Diam. Inches	Diam. Globe Inches	Extreme Depth Inches	Weight Pounds
		3-1/2	3-1/4	2-3/4	1-3/4

Spare Toggle Switch, Specify, Fig. 745

Spare Sockets, Specify Fig. 24 No. 1

Spare Globes, Specify Fig. 1266, 99A

With extra packing glands installed, price on application



Fig. 1266

## ADJUSTABLE UTILITY FIXTURE – Fig. 1254

Zinc Alloy Die Casting – Chromium Plated – Bayonet D.C. Socket – Complete With 12 Volt 6 C.P. Bulb – Shield Swivels To Any Desired Position

A shielded light serving numerous requirements. For berths, instrument panels, chart table, etc.

Each	Diameter Overall Inches	Length Neck Inches	O.D. Neck Inches	Weight Ounces
	2-5/8	3/4	7/8	6

Spare Socket, Specify Fig. 24 No. 1



## UTILITY LIGHT—Fig. 140

White Nylon – With 12 Volt Lamp

For instruments, charts or general fair illumination.

Each	Size Inches	Weight Ounces	Standard Package
	1-3/8 x 5/8	1/4	10

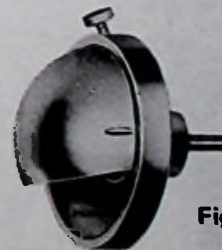

Fig. 1254

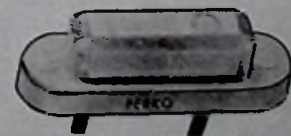

Fig. 140

## SKIN PACK – Fig. 140-SP

One Light Per Card

Ten Cards Per Box

Weight Per Box, 2½ Ounces

Sold To Trade In Full Box Only

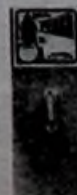

Fig. 140-SP

## ANTIQUE DESIGN SHIPS LANTERNS

Although these lanterns are manufactured now, the design is unchanged from that of centuries ago.

Old sailing vessels used Fig. 44 for cabin illumination and signaling.

The bulkhead lantern Fig. 1045 was used for illumination in cabins, passage-ways, decks, etc.

These lanterns are hand made of non-corrosive material by the Country's oldest and leading manufacturer of marine navigation lights. They are authentic marine lanterns, not imitations. They are offered primarily for decorative purposes. They are not wired and are not intended to conform with any specific electrical code or standard. This also applies to the lanterns on Page D-7.



Fig. 44

### OIL SIGNAL LIGHT—Fig. 44

Polished Brass — With Clear Globe

No.	Diam. Globe Inches	Height Overall Inches	Weight Pounds
1	6	11-1/2	2
2	8	14-1/2	4
3	10	18	7-1/2

Available with Frosted Globe, Specify Fig. 44-F and size.

With Medium Screw Electric Adapter, Specify Fig. 44-B and Type of Globe.

### SPARE PARTS

No.	Burners	Oil Founts	Electric Adapters
1	Fig. 246	Fig. 287	Fig. 274
2	Fig. 246	Fig. 286	Fig. 292
3	Fig. 242	Fig. 282-1	Fig. 288-1

Spare Globes, Specify Fig. 264, Frosted or Clear and Size

10 Inch Size supplied with Fig. 267 Chimney



Fig. 1045

### BULKHEAD LANTERN—Fig. 1045

With Medium Screw Electric Socket — Not Wired

Polished Brass — With Mounting Bracket

Illumination thru translucent "Solar Bronze" glass enclosure on front and two sides. A beautiful lantern with a design history to the 15th century.

No.	Each	Width Inches	Height Less Handle Inches	Depth Less Bracket Inches	Weight Pounds
2		10	17	7 3/4	5

Spare Front Glasses, Specify Fig. 1045-99A

Spare Side Glasses, Specify Fig. 1045-99B

Spare Sockets, See Fig. 346 No. 1

Spare Mounting Bracket, See Fig. 131 Brass



Fig. 49

### NAVY OR LIFE BOAT LANTERN—Fig. 49

Oil Burning — Hinged Top — Clear Globe

Galvanized Each	Polished Brass Each	Height Inches	Size of Globe Inches	Weight Pounds
		11	4x6-1/2	3

Spare Globes, Specify Fig. 262

Electric Adapter, See Fig. 292, Section A



## ELECTRIC SIGNAL LIGHT – Fig. 1032-F

All Brass – Medium Screw Electric Socket –  
Canopy and Chain With White Frosted Globe –  
Supplied with 12 inches of chain, and glass bottom  
for illumination of deck.

No.	Polished Brass Each	Height Lamp Only Inches	Diam. Globe Inches	Approx. Weight Pounds
1		11	6	3
2		14	8	4-1/2
3		16-1/2	10	6-1/2

With Clear Globe, Specify Fig. 1032-CL and Size  
Spare Globes, Specify Fig. 264, Frosted or Clear and Size  
Spare Medium Screw Socket, Specify Fig. 372.



Fig. 1032-F

## ELECTRIC ANCHOR LIGHTS – Fig. 1024

With Ceiling Canopy  
All Brass – Medium Screw Electric Socket –  
With dome glass bottom for illumination of deck  
Globe is clear Fresnel

Length of Chain, 12 inches

Sizes No. 1 and 2 Have Vertical Guards Only

Sizes No. 3 and 4 Have Vertical and Horizontal Guards

No.	Polished Brass Each	Height Lamp Only Inches	Diam. Lamp Inches	Height Lens Inches	Fig. 261 Lens Sizes	Approx. Weight Pounds
1		8-5/8	4-1/2	3-5/16	Jr.	2
2		11-3/4	5-5/8	4-1/4	Sr.	2-1/2
3		14-1/2	7-1/2	6-3/4	No. 1	10
4		17-3/4	9-3/4	7-1/8	No. 2	14

With Red Globe, Specify Fig. 1024-R and Size  
With Green Globe, Specify Fig. 1024-G and Size  
With Amber Globe, Specify Fig. 1024-M and Size  
With Frosted Globe, Specify Fig. 1024-F and Size  
Spare Globes, See above  
Spare Sockets, Specify Fig. 372



Fig. 1024

## ELECTRIC ANCHOR LIGHTS – Fig. 1025

With Wall Bracket  
Construction and Other Specifications Same as Fig. 1024

No.	Polished Brass Each	Height Lamp Only Inches	Diam. Lamp Inches	Height Lens Inches	Approx. Weight Pounds
1		8-5/8	4-1/2	3-5/16	2
2		11-3/4	5-5/8	4-1/4	2-1/2

With Red Globe, Specify Fig. 1025-R and Size  
With Green Globe, Specify Fig. 1025-G and Size  
With Amber Globe, Specify Fig. 1025-M and Size  
With Frosted Globe, Specify Fig. 1025-F and Size  
Spare Globes, Fig. 261 See Fig. 1024 for Sizes  
Spare Sockets, Specify Fig. 372



Fig. 1025



Fig. 312

**UNIVERSAL WALL OIL LAMP — Fig. 312**

Brass

Polished Brass Each	Height of Back Inches	Diam. of Fount Inches	Weight Pounds
	9	5	1-1/2

Spare Burners, Specify Fig. 173  
 Spare Chimneys, Specify Fig. 94  
 Spare Wicks, See Fig. 302 No. 2



Fig. 168

**JUNIOR CABIN OIL LAMP — Fig. 168**

Double Swing — Weighted Base — All Brass

Same construction as our well known Newport Cabin Lamp Fig. 141, but reduced in size for use where space or headroom is limited.

Polished Brass Each	Chromium Plated Each	Overall Height Inches	Extension Inches	Capacity Fount Pints	Weight Ounces
		9	5	1/2	19

Spare Burners, Specify Fig. 231 and Finish  
 Spare Chimneys, Specify Fig. 230  
 Spare Wicks, See Fig. 302 No. 0



Fig. 141

**NEWPORT CABIN OIL LAMP — Fig. 141**

Double Swing — Weighted Base — All Brass

This lamp is of very sturdy construction, and minimum practical extension from wall. Diameter of wall plate 2-1/2 inches.

No.	Polished Brass Each	Chromium Plated Each	Overall Height Inches	Extension Inches	Capacity Fount Pints	Weight Pounds
1			10-1/2	5-1/2	1	1-3/4
2			12-1/2	6	1-1/4	2

	For No.1 Specify	For No.2 See
*Spare Burners . . . . .	231	242
Spare Chimneys . . . . .	230	267
Spare Wicks . . . . .	302 No.0	302 No.2

\*Specify Finish



Fig. 128

**SMOKE BELL AND ARM — Fig. 128**

All Brass

No.	Polished Brass Each	Chromium Plated Each	Diam. Bell Inches	Extension to Center Inches	Weight Ounces
0			3-1/2	3-1/2	3-1/2
1			4	4	4
2			4	4	4

No. 0 size is for lamp Fig. 168.

No. 1 and 2 sizes are for lamp Fig. 141.

Spare Arms, Specify Fig. 128-99A, Size and Finish.

**PERKO®**

# SEARCHLIGHTS

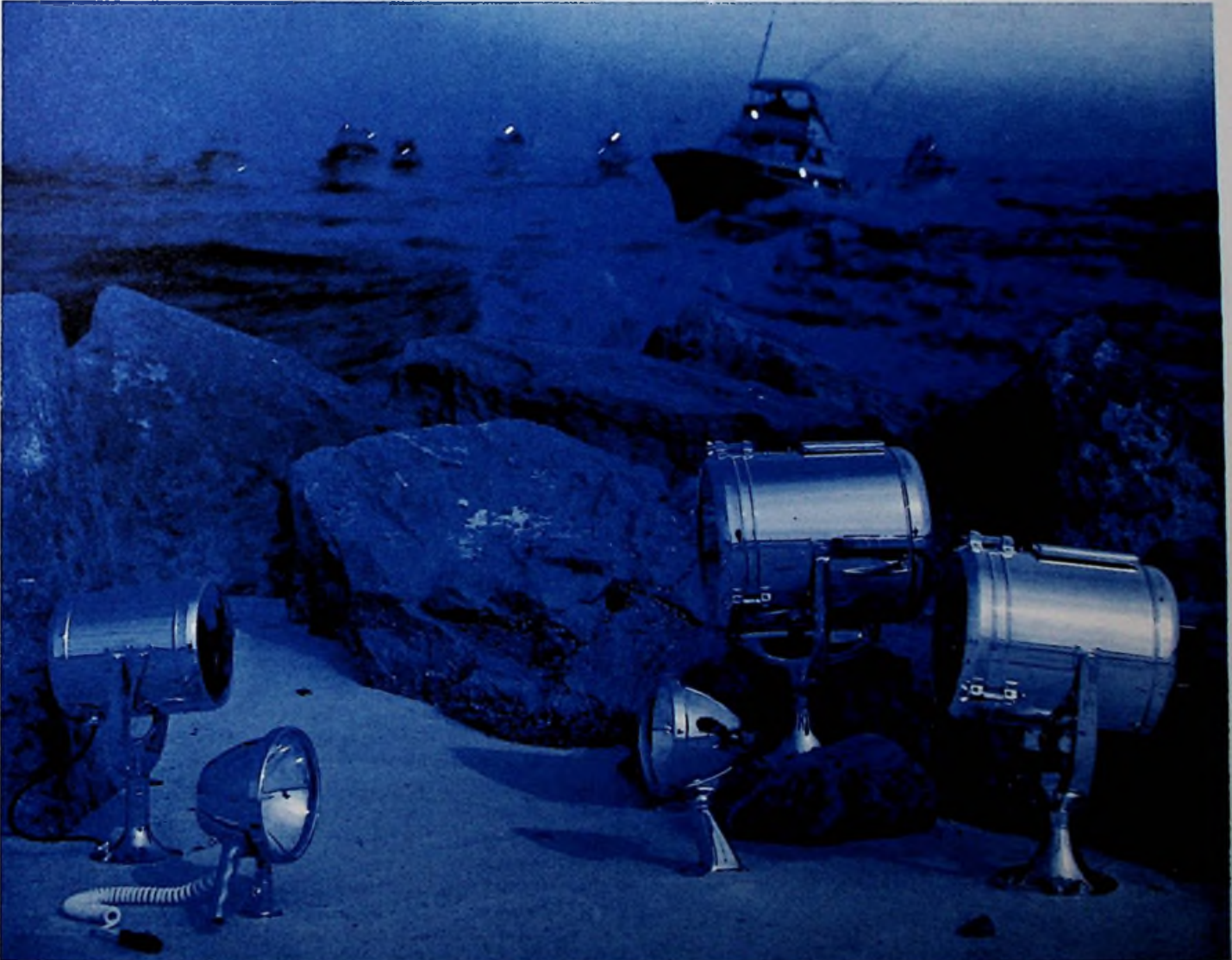

MANUFACTURED BY PERKO, INC., 16490 N.W. 13TH AVE., P.O. BOX 64000-D, MIAMI, FLORIDA 33164

FOR COMPLETE LINE SEE CATALOG NO. 230

PERKO, INC.  
ALL RIGHTS RESERVED

PORTIONS OF THIS CATALOG PREVIOUSLY  
COPYRIGHTED IN 1936 THRU 1976 INCLUSIVE.

## "SOLAR-RAY®" SEARCHLIGHTS

ALL VENTED - HALO DEFLECTORS

High Power - Mirror Reflector - 6-12-24-32-120 Volts - Heavy Gauge Brass Body  
 - Cast Bronze Base Parts - Waterproof Construction - Threaded Focusing Device.  
 3 Wire Cable, Grounded. Controls Are Chromium Plated

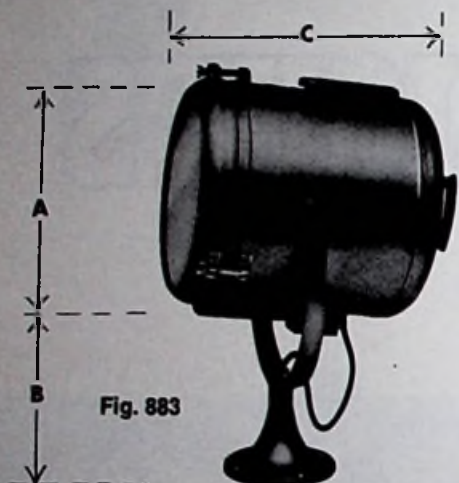

Fig. 883 DECK CONTROL

No.	Polished Brass Finish Each	Satin* Chrome Finish Each	Polished Chrome Finish Each
1			
2			
3			

Dimensions And Weight

No.	Diam. Reflector Inches	"A" Inches	"B" Inches	"C" Inches	"D" Inches	Weight Pounds
1	10	10-1/8	9	13	7	25
2	12	12-1/8	10	15	7	33
3	14	14-1/8	11	17	7	45



Fig. 884 LEVER CONTROL

No.	Polished Brass Finish Each	Satin* Chrome Finish Each	Polished Chrome Finish Each
1			
2			
3			

Dimensions and Weight

No.	Diam. Reflector Inches	"E" Inches	"H" Inches	Weight Pounds
1	10	8-1/2	2-1/8	36
2	12	8-1/2	2-1/8	44
3	14	8-1/2	2-1/8	56

Maximum Thickness of Deck, 4 Inches.

Other Dimensions see Fig. 883

Fig. 885 WHEEL CONTROL

No.	Polished Brass Finish Each	Satin* Chrome Finish Each	Polished Chrome Finish Each
1			
2			
3			

Dimensions and Weight

No.	Diam. Reflector Inches	"F" Inches	"G" Inches	"H" Inches	Weight Pounds
1	10	7-1/2	1-1/2	2-1/8	36
2	12	7-1/2	1-1/2	2-1/8	44
3	14	7-1/2	1-1/2	2-1/8	56

Maximum Thickness of Deck, 4 Inches.

Other Dimensions see Fig. 883

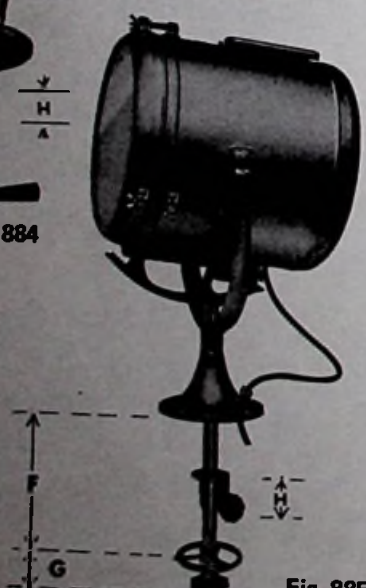

**\*NEW COMMERCIAL SATIN CHROME**  
 New commercial chrome searchlights set a new high standard for durability. Commercial chrome has a soft, non-glare satin finish with a metallic grey color. Unlike grey paint, commercial chrome is fused to Perko's heavy gaged brass searchlight bodies and cast bronze parts. There's never a need for painting because the surface is virtually scratch-proof and chip-proof and can be wiped clean with a damp cloth.

**BULB INFORMATION NECESSARY - BULBS ARE NOT INCLUDED IN LIGHTS.**

To give good results the bulb and reflector must be perfectly compatible, therefore be sure to mention the Fig. No. of the Bulb desired. Peak candlepower is exceedingly sensitive to many factors, some of which are listed below, reduction may range up to 20%. Light source out of focus by 1/32 inch. Under-Voltage of only 4%. Difference between Lamp Manufacturers. See Page E-6 for Bulbs and Spare Parts.

## "SOLAR-RAY®" SEARCHLIGHTS WITH LONGER CONTROLS

### Fig. 884-L LEVER CONTROL

No.	Diam. Reflector Inches	"E" Inches	Polished Brass Finish Each	Satin Chrome Finish Each	Polished Chrome Finish Each
1-A	10	15-1/2			
2-A	12	15-1/2			
3-A	14	15-1/2			
1-B	10	22-1/2			
2-B	12	22-1/2			
3-B	14	22-1/2			
1-C	10	29-1/2			
2-C	12	29-1/2			
3-C	14	29-1/2			



Fig. 884-L

### FIGS. 884-L AND 885-L Approximate Weight Pounds

No.	Weight Pounds
1	46
2	54
3	66

### Fig. 885-L WHEEL CONTROL

No.	Diam. Reflector Inches	"F" Inches	Polished Brass Finish Each	Satin Chrome Finish Each	Polished Chrome Finish Each
1-A	10	14-1/2			
2-A	12	14-1/2			
3-A	14	14-1/2			
1-B	10	21-1/2			
2-B	12	21-1/2			
3-B	14	21-1/2			
1-C	10	28-1/2			
2-C	12	28-1/2			
3-C	14	28-1/2			



Fig. 885-L

### NOTE

IF INSTALLATION ALSO REQUIRES SEARCHLIGHT TO BE EXTENDED ABOVE DECK THESE LIGHTS CAN BE SUPPLIED WITH HIGHER PEDESTALS AS SHOWN ON PAGE E-4. WHEN ORDERING, SPECIFY INFORMATION FOR ABOVE LIGHTS AND SUBSTITUTE "S" IN PLACE OF "L" FOR MEDIUM PEDESTAL OR "T" FOR HIGH PEDESTAL.

### SPECIAL CONSTRUCTION OF CONTROLS

WE CAN SUPPLY SPECIAL LENGTH OF CONTROLS TO ORDER. IF REQUIRED FOR FIG. 884-L, THE "E" DIMENSION MUST BE GIVEN. FOR FIG. 885-L, THE "F" AND "G" DIMENSIONS MUST BE GIVEN.

**"SOLAR - RAY®" SEARCHLIGHTS**  
**WITH MEDIUM OR HIGH PEDESTALS**  
 AVAILABLE IN POLISHED BRASS – SATIN CHROME – POLISHED CHROME PLATED

**MEDIUM BASE**

**HIGH BASE**

Size No.	Diameter Inches	"J" Inches	Weight Pounds	"J" Inches	Weight Pounds
1	10	27-1/2	51	44	53
2	12	29-1/2	59	46	61
3	14	31-1/2	71	48	73

"D" DIMENSION 8" ALL SIZES

cast bronze vent cover

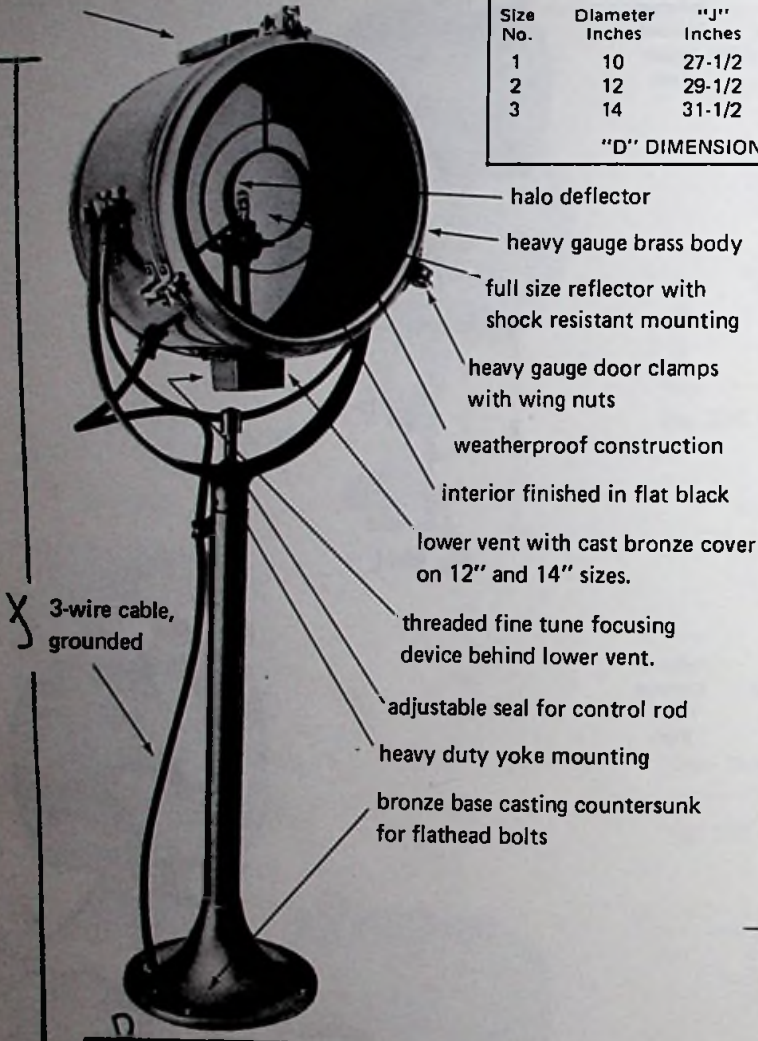

3-wire cable, grounded

- halo deflector
- heavy gauge brass body
- full size reflector with shock resistant mounting
- heavy gauge door clamps with wing nuts
- weatherproof construction
- interior finished in flat black
- lower vent with cast bronze cover on 12" and 14" sizes.
- threaded fine tune focusing device behind lower vent.
- adjustable seal for control rod
- heavy duty yoke mounting
- bronze base casting countersunk for flathead bolts

**"SOLAR-RAY®" high power searchlight features\***

**DECK CONTROL**  
 Figs. 883-M & 883-H

**LEVER CONTROL**  
 Figs. 884-M & 884-H

**WHEEL CONTROL**  
 FIGS. 885-M & 885-H

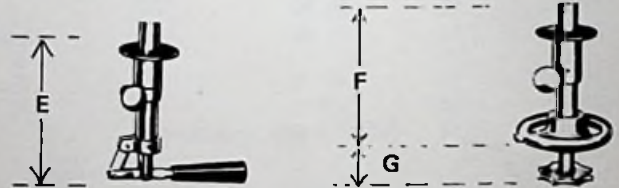

**SEARCHLIGHT SUPPORTS—Fig. 849**

Stainless steel pipe – Chromium Plated Bronze Castings  
 Adjustable for deck or bulkhead mounting.

For use with high Pedestal Lights to give additional support and stability.

No.	Each	"A" Dimensions Inches	Weight Pounds
1		28-1/2	7-1/2
2		40	8-1/2
3		43	8-3/4
4		51	9-1/4
5		75	12-1/4



Fig. 849



**SPECIAL CONSTRUCTION OF PEDESTALS**

We can supply Special Construction of Pedestals to order. If required for Figs. 884 or 885 the "J" dimension must be given.

**\*THESE FEATURES ARE STANDARD ON LIGHTS SHOWN ON PAGES E-2 AND E-3**

NEW

**"1900 SERIES SOLAR-RAY®" SEARCHLIGHTS**  
 ALL ALUMINUM – PAINTED GRAY – 120 VOLTS  
 INTERCHANGEABLE LEVER AND WHEEL CONTROLS

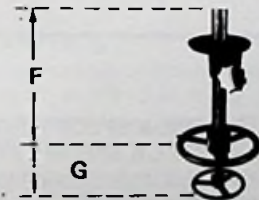
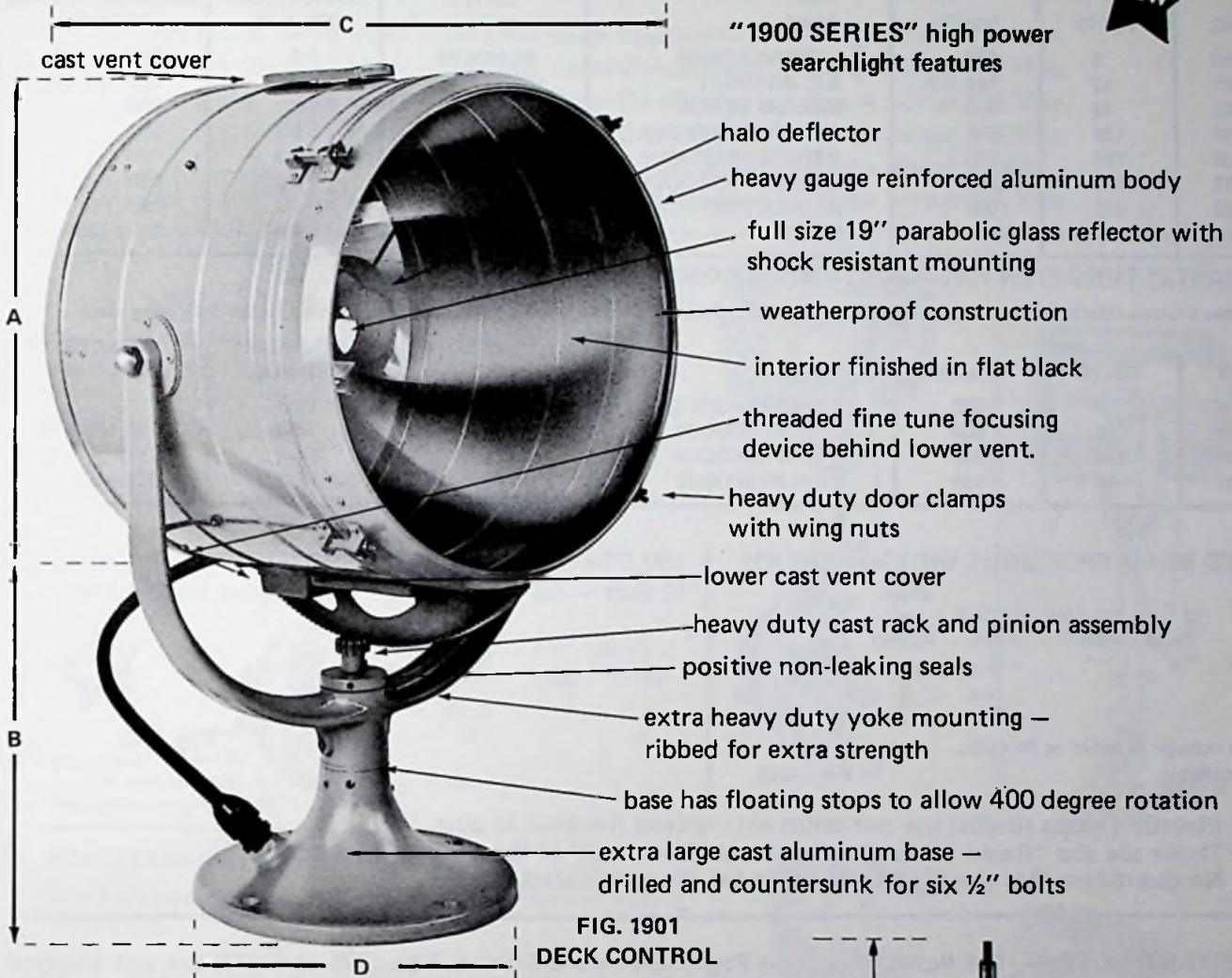

**FIG. 1903 – WHEEL CONTROL**  
 EXTRA LARGE CONTROL WHEELS FOR EASE OF OPERATION

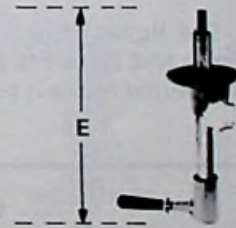

**FIG. 1902 – LEVER-GEAR CONTROL**  
 OUR NEW LEVER-GEAR CONTROL GIVES SMOOTH, ONE HAND OPERATION AND HAS BUILT-IN LOCKING KNOB TO SET POSITION OF ELEVATION

DIMENSIONS							
"A"	"B"	"C"	"D"	"E"	"F"	"G"	"H"
Inches	Inches	Inches	Inches	Inches	Inches	Inches	Inches
19-1/2	13-1/4	20-3/4	13	22	20-1/2	2-1/2	4-1/4
Weight 55 Pounds							

LAMPS FOR ABOVE – SPECIFY TYPE						
Fig. No.	Volts	Watts	Type Base	Rated Life Hours	Manufacturers Code No.	
837	120	750	Medium Prefocus	200	DDY-T12	
*839	120	900	2-Pin Prefocus	75	BVA-T7	
810	120	1000	Medium Prefocus	25	DRS-T20	
840	120	1500	Mogul Prefocus	25	DTS-T20	
843	120	2000	Mogul Prefocus	200	2MG 48/5	
*Quartz-Halogen						

HEAD AND BASE PACKED TOGETHER  
 CONTROLS PACKED SEPARATELY.

SPECIAL HEIGHTS AND EXTRA LONG CONTROL SEARCHLIGHTS –  
 PRICE ON APPLICATION – GIVE MEASUREMENTS

**IMPORTANT SEARCHLIGHT INFORMATION**

INCANDESCENT LAMP RECOMMENDATIONS						
FIG.	VOLTS	WATTS	TYPE BASE	**RATED LIFE	SEARCHLIGHT SIZE NOS.	MANUFACTURER'S CODE NO.
800	6	108	MEDIUM SCREW	50 HOURS	1-2	CPG
801	12	100 C.P.	S.C. BAYONET	100 "	1-2	1020 OR 976
802	32	300	MEDIUM SCREW	50 "	1-2	CRX
807	120	500	MEDIUM PREFOCUS	25 "	1-2-3	CZX
809	120	750	MEDIUM PREFOCUS	25 "	2-3	DPJ
837	120	750	MEDIUM PREFOCUS	200 "	2-3	DDY-T12
810	120	1000	MEDIUM PREFOCUS	25 "	2-3	DRS-T20
811	120	1000	MOGUL	25 "	2-3	DRW-T20

**"QUARTZ" TUNGSTEN-HALOGEN LAMP RECOMMENDATIONS**

For more concentrated beam, longer distance, brighter lights, longer life, etc. we suggest these lamps in the following sizes.

FIG.	VOLTS	WATTS	BASE	**RATED LIFE	SEARCHLIGHT SIZE NOS.	MANUFACTURER'S CODE NO.
816	12	100	2 PIN-PREFOCUS	50	1-2-3	FDT
817	32	200	2 PIN-PREFOCUS	50	1-2-3	G.E. 1945-G6
820	120	600	2 PIN-PREFOCUS	75	1-2-3	DYS
836	24	150	2 PIN-PREFOCUS	50	1-2-3	DZE-FDS

**SEALED BEAM SPOTLIGHT UNITS — Fig. 433**

No.	12 Volt Each	*24 Volt Each	32 Volt Each	Diam. Lens Inches
1			**N.A.	4-1/2
2			N.A.	6
3				7



Fig. 433

**NEW HALOGEN SEALED BEAM-SPOTLIGHT UNIT — FIG. 435**

12 Volt — 50 Watt — High Intensity — Longer Life

No.	Each	Diam. Lens Inches
1		4-1/2
2		6



Fig. 435

\*Rated voltage is listed at 28 volts.

\*\*Not available.

Electric Lamps (Bulbs) are not returnable unless the fault is ours.

\*\*These are the "Rated Average Laboratory Life-Hours" of the Bulb Manufacturer.

No guarantee that the life is limited to the time indicated.

**IMPORTANT NOTE** — The lights shown on Pages E-2 thru E-5 (also Figs. 305 and 313) are not shipped assembled. The head, yoke and base are packed in one carton, control assemblies in a separate carton. The control assemblies listed below make it possible to have a greater variety of searchlights with a minimum inventory.

**CONTROL ASSEMBLIES**

FOR FIGS. 305 AND 884 SPECIFY FIG. 851  
 FOR FIGS. 313 AND 885 SPECIFY FIG. 852  
 FOR FIGS. 305A AND 884L-A SPECIFY FIG. 853  
 FOR FIGS. 305B AND 884L-B SPECIFY FIG. 854  
 FOR FIGS. 305C AND 884L-C SPECIFY FIG. 855

FOR FIGS. 313A AND 885L-A SPECIFY FIG. 856  
 FOR FIGS. 313B AND 885 L-B SPECIFY FIG. 857  
 FOR FIGS. 313C AND 885L-C SPECIFY FIG. 858  
 FOR FIG. 1902 SPECIFY FIG. 1921  
 FOR FIG. 1903 SPECIFY FIG. 1922

**SPARE PARTS FOR "SOLAR-RAY<sup>®</sup>" SEARCHLIGHTS**

REFLECTORS, SPECIFY FIG. 890 AND SIZE  
 FRONT DOOR WITH GLASS, SPECIFY FIG. 891,  
 SIZE AND FINISH  
 FOCUSING DEVICE WITH HOUSING, SPECIFY FIG. 892  
 AND FINISH  
 REAR COVER OF HOUSING, FOR FIGS. 884 OR 885,  
 SPECIFY FIG. 902, SIZE AND FINISH  
 REAR COVER OF HOUSING FOR FIG. 883, SPECIFY  
 FIG. 903, SIZE AND FINISH

SPARE ELECTRIC SOCKETS —  
 S.C. BAYONET — SEE FIG. 472 NO. 21  
 MED. SCREW — SPECIFY FIG. 894  
 MED. PREFOCUS — SPECIFY FIG. 895  
 MOGUL SCREW — SPECIFY FIG. 897  
 MOGUL PREFOCUS — SPECIFY FIG. 893  
 2-PIN PREFOCUS FOR SIZES 10, 12 & 14 —  
 SPECIFY FIG. 899  
 2-PIN PREFOCUS FOR 19" SIZE —  
 SPECIFY FIG. 886



## SEALED BEAM SEARCHLIGHTS

Cast Bronze Base — Brass Body — Waterproof Construction — Position Holding Device  
 Long Distance Sealed Beam Spotlight Units 12, 24 or 32 Volts

- Size No. 2 — 12 Volts — 200,000 Beam Candlepower — Range About 1/2 Mile.
- Size No. 2H — 12 Volts — 160,000 Beam Candlepower — Range About 5/8 Mile.
- Size No. 2 — 24 Volts — 300,000 Beam Candlepower — Range About 5/8 Mile.
- Size No. 3 — 12 Volts — 250,000 Beam Candlepower — Range About 5/8 Mile.
- Size No. 3 — 24 Volts — 450,000 Beam Candlepower — Range About 1 Mile
- Size No. 3 — 32 Volts — 260,000 Beam Candlepower — Range About 3/4 Mile.

Fig.	"E" Inches	Polished Brass Finish Each	Satin Chrome Finish Each	Polished Chrome Finish Each
305	8-1/2			
305-A	15-1/2			
305-B	22-1/2			
305-C	29-1/2			

Fig.	"F" Inches	Polished Brass Finish Each	Satin Chrome Finish Each	Polished Chrome Finish Each
313	7-1/2			
313-A	14-1/2			
313-B	21-1/2			
313-C	28-1/2			

Dimensions Figs. 305 & 313	"A" Inches	"B" Inches	"C" Inches	"D" Inches	"G" Inches	"H" Inches	Weight Pounds
	8	8-1/2	10	7	2	2-1/8	14

### SPARE PARTS

Sealed Beam Units — See Fig. 433 No. 3  
 Front Bezel With Glass, Specify Fig. 354 and Finish  
 Rear Cover, Specify Fig. 355 and Finish



Fig. 313

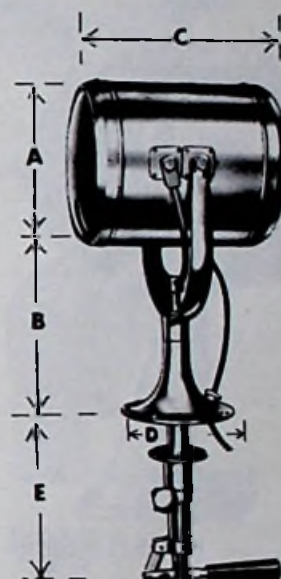

Fig. 305

### PILOT HOUSE CONTROL — Figs. 535 & 535H

With finishing plate for underside of cabin top and position locking device.

No.	12 Volt Each	24 Volt Each	32 Volt Each	Nominal Diameter Inches	Dimensions Base Inches	*Height Above Deck Inches
2			NA	6	4-7/8 x 3-1/8 x 2	12
2H		NA	NA	6	4-7/8 x 3-1/8 x 2	12
**3				7	4-7/8 x 3-1/8 x 2	12-1/2

\*\*See note on Fig. 534

For thickness of top or deck maximum 4-1/2 inches

\*Height is overall, from deck to top of head.

Length of control below base, 7-1/4 inches.



Figs. 535 & 535H



Figs. 536 & 536H

### FLEXIBLE REMOTE CONTROL — Figs. 536 & 536H

Has knob tightening device on dash for maintaining set position of head.

Fig. 536 No.	Fig. 536H No.*	Length Control Inches	12 Volt Each	12 Volt-H Each	24 Volt Each	32 Volt Each
2-A	2-AH	36				N/A
2-B	2-BH	48				N/A
2-C	2-CH	60				N/A
3-A	N/A	36				
3-B	N/A	48				
3-C	N/A	60				

For Dimensions See Fig. 535.

Figs. 534 and 535, Weight About 5 Pounds.

\*Fig. 536H, Available in 12 Volts only.

Special lengths longer than above, Price on application.

Maximum length for smooth operation is 12 feet.

### NOTE

The NEW "H" SERIES SEARCHLIGHTS listed above are equipped with High-Intensity HALOGEN SEALED BEAM UNITS which produce a Brighter, More Piercing Beam and last up to 2-1/2 times longer than ordinary sealed beam units.

## SEALED BEAM SEARCHLIGHTS

All Brass – Chromium Plated – Clear Lens



Figs. 538 & 538H

DECK CONTROL – Figs. 538 & 538H  
With Switch in Head

Fig. 538 12 Volts – 50,000 Beam C.P. – Range About 1/4 Mile  
Fig. 538H 12 Volts – 100,000 Beam C.P. – Range About 1/2 Mile



Each	Diam. Lens Inches	Diam. Base Inches	Height Overall Inches	Weight Pounds
	4-1/2	3-1/2	7-1/2	1-1/2



DECK CONTROL – Figs. 534 & 534H

With Switch – 12, 24 or 32 Volts

Size No. 2 – 12 Volts – 200,000 Beam Candlepower – Range About 1/2 Mile.  
Size No. 2-H – 12 Volts – 160,000 Beam Candlepower – Range about 5/8 Mile.  
Size No. 2 – 24 Volts – 300,000 Beam Candlepower – Range About 5/8 Mile.  
Size No. 3 – 12 Volts – 250,000 Beam Candlepower – Range About 5/8 Mile.  
Size No. 3 – 24 Volts – 450,000 Beam Candlepower – Range About 1 Mile.  
Size No. 3 – 32 Volts – 260,000 Beam Candlepower – Range About 3/4 Mile.

Horizontal Rotation 350 Degrees



Figs. 534 & 534H

No.	12 Volt Each	24 Volt Each	32 Volt Each	Nominal Diameter Inches	Dimensions Base Inches	*Height Above Deck Inches
2			N/A	6	4-7/8 x 3-1/8 x 2	12
2H		N/A	N/A	6	4-7/8 x 3-1/8 x 2	12
**3				7	4-7/8 x 3-1/8 x 2	12-1/2



Weight about 5 pounds.

\*Height is overall, from deck to top of head.

Length of head excluding handle 6 inches.

Spare Sealed Beam Units, See Figs. 433 and 435.

NOTE –

\*\*This size has a larger, more powerful sealed beam unit. It does not have the lens bezel illustrated. The unit is held in by a snap ring. Easily removable for quick replacement.



HAND SPOTLIGHTS – Figs. 440 & 440H

Push Button Switch – 8 Feet of Coiled Cord

Cigar Lighter Plug and D.C. Plug With Socket

Removable from Deck Socket for Portable Operation

No. 1–12 Volts–50,000 Beam C.P.–Range About 1/4 Mile.

No. 1-H–12 Volts, 100,000 Beam C.P.–Range About 1/2 Mile.

No. 3–12 Volts–250,000 Beam C.P.–Range About 5/8 Mile.

No. 3–32 Volts–260,000 Beam C.P.–Range About 3/4 Mile.



Figs. 440 & 440H SPOTLIGHTS

Fig. 457 COMB. SPOT AND FLOODLIGHT



No.	12 Volt Each	32 Volt Each	Diam. Lens Inches	Weight Pounds
1		N/A	4-1/2	2-1/4
1H		N/A	4-1/2	2-1/4
3			7	3-1/2



COMBINATION SPOT AND FLOODLIGHT – Fig. 457

Equipped as Above, 12 Volts, Switch is Three Position –  
1st Spot, 2nd Flood, 3rd Off

Sealed Beam Unit Has Dual 100 Watt Filaments

No.	Each	Diam. Lens Inches	Weight Pounds
1		4 1/2	2 1/4
3		7	3 1/2

SPARE PARTS

Sealed Beam Units for Figs. 440 & 440H, See Figs. 433 and 435.

Sealed Beam Units for Fig. 457, Specify Fig. 457-99 A and Size

3 Position Switches, Specify Fig. 457-99 B

Cigar Lighter Plug, Specify Fig. 456

Deck Sockets for Light, Specify Fig. 494

D.C. Connections, See Fig. 1190

NOTE

The NEW "H" SERIES SEARCHLIGHTS listed above are equipped with High-Intensity HALOGEN SEALED BEAM UNITS which produce a Brighter, More Piercing Beam and last up to 2-1/2 times longer than ordinary sealed beam units.

SECTION F

**PERKO®**

**BLOWERS**

**VENTILATORS**

**VENTS**

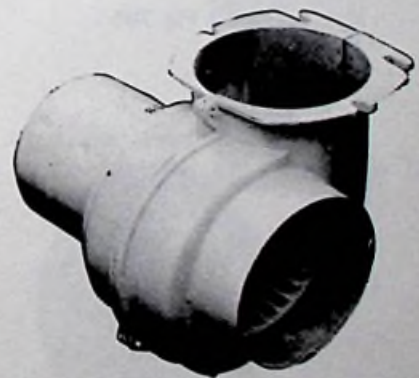
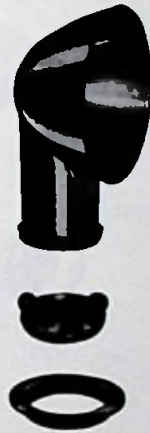

MANUFACTURED BY PERKO, INC., 16490 N.W. 13TH AVE., P.O. BOX 64000-D, MIAMI, FLORIDA 33164

FOR COMPLETE LINE SEE CATALOG NO. 230

© PERKO, INC.  
ALL RIGHTS RESERVED

PORTIONS OF THIS CATALOG PREVIOUSLY  
COPYRIGHTED IN 1936 THRU 1976 INCLUSIVE

## MARINE EXHAUST BLOWERS—Fig. 778

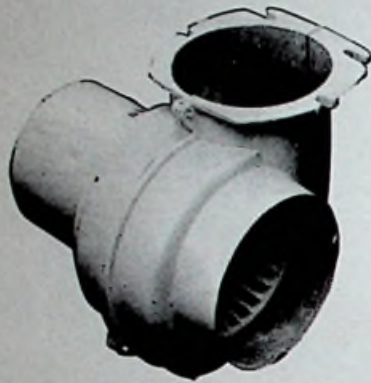

Fig. 778

**HEAVY DUTY MOTOR WITH 18 - 8 NON-MAGNETIC STAINLESS STEEL SHAFT - WHITE DELRIN IMPELLER - 12 VOLTS**

**TESTED AND ACCEPTED FOR LABELING AND LISTING BY THE UNDERWRITERS LABORATORIES, INC.**

For removing fumes from the bilge and engine room, exhausting excess heat and cooking odors from the galley. Getting rid of foul air or odors from cargo holds and bilges.

**Size No. 1 - Die Cast Housing, Satin Chromium Finish. Hose clamps are no longer necessary as the 3" duct is threaded into the inlet with a couple of turns. Saves time of installation and cost of clamps.**

**Size No. 2 - Cast Aluminum Housing, Natural Finish.**

No.	Size Intake Inches	Size Outlet Inches	Dimensions Overall Inches	Rated C.F.M.	Size Flange Inches
1	3	3	6-1/2 x 6 x 5	117	4 x 3 1/2
2	4	3-3/4	8 x 8 x 7	250	4 3/4 x 4 3/8

No.	Each	Weight Pounds
1		3
2		6

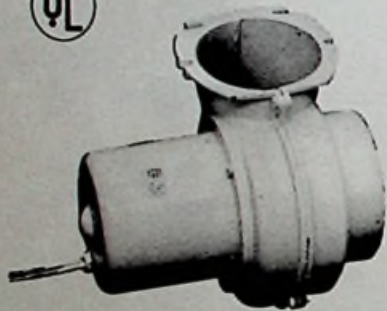

Fig. 791

## MARINE EXHAUST BLOWERS— Fig. 791

12 Volts

This is our improved Fig. 778 Blower with the motor enclosed in an additional housing. The stainless steel shaft passes through a neoprene seal and the electric cable through a waterproof rubber gland.

No.	Size Intake Inches	Size Outlet Inches	Dimensions Overall Inches	Rated C.F.M.	Flange Inches
1	3	3	7-1/2 x 6 x 5	117	4 x 3-1/2
2	4	3-3/4	8-1/2 x 8 x 7	250	4-3/4 x 4-3/8

No.	Each	Weight Pounds
1		3 1/2
2		6 1/2



Fig. 193



## BLOWER AND IGNITION SWITCH—Fig. 193

**RED PLASTIC HOUSING - VAPOR PROOF - MULTIPLE POLE - COPPER CONTACTS - STAINLESS STEEL SPRING.**

**TESTED AND ACCEPTED FOR LABELING AND LISTING BY THE UNDERWRITERS LABORATORIES, INC.**

With these improved switches the engine cannot be started before the blower has been turned on, then before the engine can be stopped the blower must again be started thus helps to clear out any remaining fumes before and after engine operations.

Can be installed flush or offset. Supplied with complete set of 4 offset mounting legs.

Each	Diameter Inches	Depth Inches	Weight Ounces
	5	1-3/4	10

### SPARE PARTS

Motors for Fig. 778 and 791, Specify Fig. 822 and Size.

Impellers for Figs. 778 and 791, Specify Fig. 824 and Size.

Spare Offset Mounting Legs (Set of 4) for Fig. 193, Specify Fig. 103

## EXHAUST DUCT – Fig. 789

Vinyl – with high tensile spring wire coil non-flammable – resists many corrosive chemicals – long life under exposure to sunlight – color is blue.

Supplied only in 25 foot lengths, 2 lengths per carton. Shipped only in full cartons.

No.	Inside Diameter Inches	Per Length	Weight Per Carton Pounds
2	3		12
3	3-1/2		12
4	4		13



Fig. 789

---

## MOUNTING ADAPTERS FOR EXHAUST DUCT – Fig. 787

Die Cast Zinc Alloy – Satin Chromium Finish

For Blower size No. 1 only.

For outlet end of duct or to support free end of duct in various installations. Can be fastened thru the base under deck or thru side if preferred.



Fig. 787

Each	Dimensions Inches	Weight Ounces
	3-3/4 x 3-1/2 x 1-5/8	14

---

## COWL VENTILATORS – Fig. 510

Fixed or Swivel Cowl

Round Mouth – With Threaded Deck Plate – Sheet Steel or Sheet Brass – Cast Bronze Deck Plate

Steel ventilators are finished in White Acry-Color.

Has internal thumb screw to permit turning cowl to desired direction quickly and lock in position.

Deck Plate Size Inches	White Each	Polished Brass Each	Chromium Plated Each	Diam. Mouth Inches	Height Overall Inches	Weight Pounds
4				8	11	4
5				10	13	6
6				12	16	9
8				16	21	15-1/2

Fig. 510



Spare Deck Plates, See Fig. 526



Fig. 1312

**"CHROMALEX" COWL VENTILATORS - Fig. 1312**

Die Cast Zinc Alloy – Chromium Plated

Black Plastic Base – For 3 Inch Duct

Designed for fast mounting.

No Screw Heads will show. Has integral Air Scoop.

No Hose Clamps Necessary – Duct threads into collar.

Each	Mouth Opening Square Inches	Length Overall Inches	Width Overall Inches	Height Overall Inches	O.E.M. Package	Weight Ounces
	7	5-3/4	4-3/8	2-5/8 <sup>®</sup>	50	11



See Section "M" for Our New "Chromalex" III Cowl Ventilator



Fig. 1312-SP

**SKIN PACK – Fig. 1312-SP**

One Ventilator Per Card.

Four Cards Per Box.

Weight Per Box, 3 Pounds.

Sold To Trade In Full Box Only.



See Section "L" for Our New "Chromalex"<sup>®</sup> Skin Pack Cowl Ventilator



Fig. 654 Bronze  
Fig. 870 Die Cast

**FLANGED VENTILATOR WITH COLLAR – Figs. 654 & 870**

Fig. 654, Cowl is Cast Bronze, Flange and Collar are Die Cast Zinc Alloy. Fig. 870 is all Die Cast Zinc Alloy.

**CHROMIUM PLATED**

Duct Threads into Size 2 Collar. No clamps necessary.

No.	Fig. 654 Each	Fig. 870 Each	I. D. Duct Inches	Mouth Square Inches	Length Overall Inches	Width Overall Inches	Nominal Weight Ounces
2			3	7	5-1/4	4	25
3	N.A.		3 1/2	10	6-1/4	4-3/4	27



**MIDGET CLAM SHELL VENTILATOR – Fig. 315**

Brass – Chromium Plated



Fig. 315

No.	Each	Base Dimensions Inches	Height Opening Inches	Thickness Inches	For Screw No.	Weight Ounces
1		1-5/8x1-1/2	7/16	.040	6	1/2
2		2 x2	9/16	.064	6	1-1/4

Standard Package, 10 Pieces



**SKIN PACK – Fig. 315-SP**

No. 2 Size

One Ventilator Per Card,

Twelve Cards Per Box,

Weight Per Box, 1 1/2 Pounds.

Sold To Trade In Full Box Only



Fig. 315-SP



Fig. 339

**CLAM SHELL VENTILATOR – Fig. 339**

Brass – Chromium Plated

Each	Width Opening Inches	Height Opening Inches	Base Dimensions Inches	For Screw No.	Weight Ounces
	2-1/2	1-5/8	4 x 3-3/4	6	5

Standard Package, 5 Pieces



**SKIN PACK – Fig. 339-SP**

One Ventilator Per Card,

Six Cards Per Box,

Weight Per Box, 4 Pounds.

Sold To Trade In Full Box Only.



Fig. 339-SP

## GAS TANK VENT—Fig. 505

**Pressure Cast Bronze — Chromium Plated**  
**With Removable Brass Wire Mesh Flame Arrester.**

Designed to meet the requirements of the National Fire Protection Assn. Booklet No. 302 Section No. 323 on vent pipe outlets.

The Flame Arrester is 30 x 30 mesh. The 1/2" I.P.T. is off center to create a water baffle.

Each	Diameter Flange Inches	O.D. Neck Inches	Length Neck Inches	Weight Ounces
	2-1/2	1-3/16	1-1/2	6-1/2

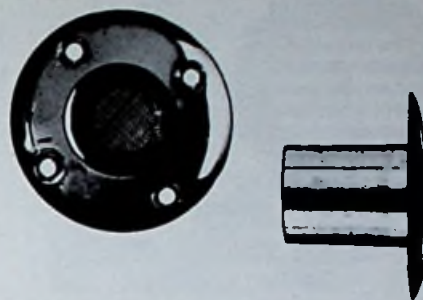

Fig. 505

★

## GAS TANK VENT—Fig. 506

**Die Cast Zinc Alloy — Chromium Plated —**  
**With Removable Copper Wire 30 Mesh Screening**

Fig.	Size No.	Each	Hose Size Inches	Max. Wood Thickness Inches	Weight Ounces
506	4		5/8	3/4	2



Fig. 506

Standard Package, 10 Pieces.

Spare Nuts for Fig. 506, Specify Fig. 506-99A.

★

## GAS TANK VENT—Fig. 509

**Pressure Cast Bronze — Chromium Plated —**  
**With Removable Copper Wire 30 Mesh Screening**

Fig.	Size No.	Each	Hose Size Inches	Max. Wood Thickness Inches	Weight Ounces
509	4		5/8	3/4	4
509	5		3/4	3/4	6



Fig. 509

Standard Package, 10 Pieces.

Spare Nuts for Fig. 509, Specify Fig. 509-99A and Size.

★

## GAS TANK VENTS—Fig. 503

**Pressure Cast Bronze — Chromium Plated —**  
**With Removable Copper Wire 30 Mesh Screening**

No.	Each	Neck Pipe Size Inches	Elbow Pipe Size Inches	Max. Wood Thickness Inches	Weight Ounces
3		3/8	3/8x3/8	1	5-1/2
4		1/2	1/2x1/2	7/8	6



Fig. 503

Standard Package, 5 Pieces.

★

## GAS TANK VENTS—Fig. 515

**Pressure Cast Bronze — Chromium Plated —**  
**With Removable Copper Wire 30 Mesh Screening**

No.	Each	Pipe Size Inches	Max. Wood Thickness Inches	Weight Ounces
3		3/8	7/8	3-3/4
4		1/2	7/8	5-1/4



Fig. 515

Standard Package, 10 Pieces.

Spare Nuts, See Fig. 75

All above vents are designed to meet the requirements of  
 USCG Safety Standards January 31, 1977  
 for gasoline fuel systems.



Fig. 330

**LOCKER VENTILATORS – Fig. 330**

**18-8 Stainless Steel – Polished**

No.	Each	Diameter Inches	For Screw No.	Weight Ounces
1		2-1/2	6	1
2		3-1/4	6	2

Standard Package, 10 Pieces



Fig. 330-SP

**SKIN PACK – Fig. 330-SP**

**No. 2 Size**

One Ventilator Per Card,  
Twelve Cards Per Box,  
Weight Per Box, 1½ Pounds.

Sold To Trade In Full Box Only.



Fig. 550

**TRANSOM OR LOCKER VENTILATOR – Fig. 550**

**18-8 Stainless Steel – Polished**

Each	Dimensions Inches	For Screw No.	Weight Ounces
	7 x 2-1/2	8	3

Standard Package, 10 Pieces

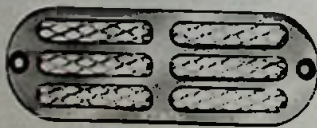

Fig. 1271

**TRANSOM OR LOCKER VENTILATOR – Fig. 1271**

**Die Cast Zinc Alloy – Chromium Plated**

**With Grill Type Screen**

Each	Dimensions Inches	For Screw No.	Weight Ounces
	6 x 2	8	3

Standard Package, 10 Pieces



Fig. 1238

**TRANSOM OR LOCKER VENTILATOR – Fig. 1238**

**Die Cast Zinc Alloy – Chromium Plated –**

**With Grill Type Screen**

Each	Dimensions Inches	For Screw No.	Weight Ounces
	8-3/8 x 2-1/4	8	3

Standard Package, 10 Pieces



## LOUVER VENTILATORS—Fig. 334

Stainless Steel 18-8 Alloy No. 304  
Polished

No.	Each	Size Inches	Length Louvers Inches	Weight Ounces
2		3 x 2-1/2	2	1
2-A		4 x 2-1/2	3	1-1/2
4		5-1/2 x 2-1/2	2	2
4-A		7-1/2 x 2-1/2	3	2-1/2
6		8 x 2-1/2	2	3
6-A		11 x 2-1/2	3	4



#2



#4

Fig. 334



#6

Standard Package, 10 Pieces per size



## LOUVER VENTILATORS—Fig. 335

Stainless Steel 18-8 Alloy No. 304  
Polished

No.	Each	Size Inches	Length Louvers Inches	Weight Ounces
3		3 x 3	2	1-1/2
3-A		4 x 3-1/2	3	2
6		5-1/2 x 3	2	2-1/2
6-A		7-1/2 x 3-1/2	3	3-1/4
9		8 x 3	2	3-1/2
9-A		11 x 3-1/2	3	4



#3



#6

Fig. 335

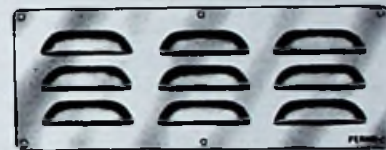

#9

Standard Package, 10 Pieces Per size



## LOUVER VENTILATORS—Fig. 336

Stainless Steel 18-8 Alloy No. 304  
Polished

No.	Each	Size Inches	Length Louvers Inches	Weight Ounces
4		3-3/4 x 3	2	1-3/4
4-A		4-3/8 x 4	3	2
5		4-1/2 x 3	2	2
5-A		5-3/8 x 4	3	2-1/4
6		5-1/4 x 3	2	2-1/2
6-A		6-3/8 x 4	3	3



#4



#6

Fig. 336

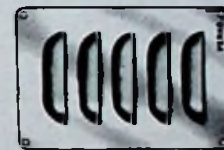

#5

Standard Package, 10 Pieces Per size



## OUTBOARD GAS TANK CLAMPS—Fig. 1275

Die Cast Zinc Alloy

Made to fit most gas tanks now in use. By turning the top portion 180 degrees it will fit tanks with the seam folded either vertically or horizontally.

Each	Length Inches	Width Inches	Weight Ounces
	1-1/2	1	2



Fig. 1275

Standard Package, 10 Pieces

BUY STANDARD PACKAGES



SECTION G

**PERKO®**

**windows and  
portlights**

**sinks**

**lead lines**

**bells  
fog horns  
etc.**

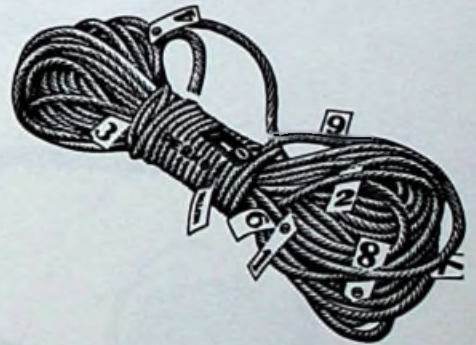

MANUFACTURED BY PERKO, INC., 16490 N.W. 13TH AVE., P.O. BOX 64000-D, MIAMI, FLORIDA 33164

FOR COMPLETE LINE SEE CATALOG NO. 230

## MARINE WINDOWS WITH SPIGOT – Fig. 796

Cast Bronze or Aluminum – Plain Finish  
Watertight – Two Fastenings – Clear Glass

Screen and Finishing Frame Not Included

See Figs. 812, 813 and 814.

Length of spigot is 2 inches. Glass thickness is 1/4 inch.



Fig. 796

No.	Size of Opening Inches	Plain Bronze Each	Plain Aluminum Each		
1	5x12				
2	7x16				
	Dimensions Outside of Frame Inches	Dimensions Outside of Spigot Inches	Bronze Weight Pounds	Aluminum Weight Pounds	
1	7 <sup>7</sup> / <sub>8</sub> x 14 <sup>7</sup> / <sub>8</sub>	5 <sup>3</sup> / <sub>8</sub> x 12-7/16	13	5	
2	10 <sup>7</sup> / <sub>8</sub> x 19 <sup>1</sup> / <sub>4</sub>	7 <sup>1</sup> / <sub>2</sub> x 16 <sup>1</sup> / <sub>2</sub>	21	7 <sup>1</sup> / <sub>2</sub>	

Spare Wing Nuts for Bronze Windows, See Fig. 453 No. 4.

Spare Wing Nuts for Aluminum Windows, Specify Fig. 796-99A



## MARINE WINDOWS WITHOUT SPIGOT – Fig. 803

Cast Bronze or Aluminum – Plain Finish  
Watertight – Two Fastenings – Clear Glass

Screen and Finishing Frame Not Included

See Figs. 812, 813 and 814

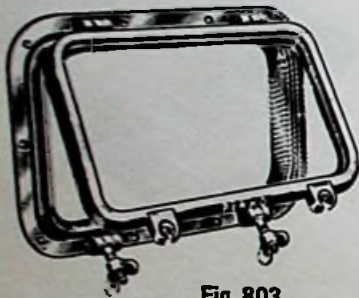

Fig. 803

No.	Size of Opening Inches	Plain Bronze Each	Plain Aluminum Each	Bronze Weight Pounds	Aluminum Weight Pounds
1	5 x 12			10 <sup>1</sup> / <sub>2</sub>	4 <sup>1</sup> / <sub>4</sub>
2	7 x 16			16	6 <sup>1</sup> / <sub>2</sub>

For Frame Dimensions, See Fig. 796

Spare Wing Nuts for Bronze Windows, See Fig. 453 No. 4.

Spare Wing Nuts for Aluminum Windows, Specify Fig. 803-99A



## OUTSIDE FINISHING FRAMES – Fig. 812

Cast Bronze or Aluminum – Plain Finish

For Figs. 796 or 803

Countersunk Screw Holes Placed as Illustrated. Not in Line With Mounting Holes of Window Frame.

These Fit Over the Outside of the Spigot on Fig. 796.

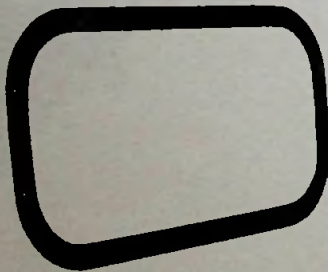

Fig. 812

No.	Bronze Each	Aluminum Each	Inside Dimensions Inches	Outside Dimensions Inches	Bronze Weight Pounds	Alum. Weight Pounds
1			5 <sup>1</sup> / <sub>2</sub> x 12 <sup>1</sup> / <sub>2</sub>	7 <sup>1</sup> / <sub>4</sub> x 14 <sup>1</sup> / <sub>4</sub>	1 <sup>1</sup> / <sub>2</sub>	<sup>1</sup> / <sub>2</sub>
2			7 <sup>1</sup> / <sub>2</sub> x 16 <sup>1</sup> / <sub>2</sub>	9 <sup>1</sup> / <sub>4</sub> x 18 <sup>1</sup> / <sub>4</sub>	2 <sup>1</sup> / <sub>4</sub>	<sup>5</sup> / <sub>8</sub>



## OUTSIDE BOLT-THRU FRAMES – Fig. 813

Cast Bronze or Aluminum – Plain Finish.

For Figs. 796 or 803

Bolt Holes in Line With Mounting Holes of Window Frame.

These Fit Over the Outside of the Spigot on Fig. 796.



Fig. 813

No.	Bronze Each	Aluminum Each	Inside Dimensions Inches	Outside Dimensions Inches	Bronze Weight Pounds	Alum. Weight Pounds
1			5 <sup>1</sup> / <sub>2</sub> x 12 <sup>1</sup> / <sub>2</sub>	7 <sup>3</sup> / <sub>4</sub> x 14 <sup>3</sup> / <sub>4</sub>	2 <sup>3</sup> / <sub>8</sub>	<sup>3</sup> / <sub>4</sub>
2			7 <sup>1</sup> / <sub>2</sub> x 16 <sup>1</sup> / <sub>2</sub>	10 <sup>1</sup> / <sub>8</sub> x 19 <sup>1</sup> / <sub>8</sub>	3 <sup>1</sup> / <sub>2</sub>	1

## ROUND PORTLIGHTS—Fig. 317

Cast Bronze — Glass Area Is Same Diameter As Opening

Diam. Opening Inches	Plain Bronze Each	Diam. Clear Glass Inches	Outside Diam. Frame Inches	Thickness Glass Inches	O.D. Spigot Inches	Weight Pounds
4		4	7	1/4	4-3/8	3-3/4
5		5	8	1/4	5-7/16	5
6		6	9	1/4	6-3/8	6-1/2
*8		8	11-5/8	1/4	8-1/2	10-1/4

\*8" size has two dog bolts.

Length of Spigot for All Sizes is 3/8"



Fig. 317

## MORE-AIR PORTLIGHTS—Fig. 157

Cast Bronze — Complete With Outside Finishing Ring — Glass Area Is Same Diameter As Opening — All Sizes Are Grooved For Screens

Overall Length of Spigot without Flange is 1 3/4"

Length of Spigot Between Flange and Ring is 1 1/2"

Opening Inches	Plain Bronze Each	Outside Diameter Frame Inches	Thickness Glass Inches	O.D. Spigot Inches	Weight Pounds
4		7	1/4	4-3/8	4-3/4
5		8	1/4	5-7/16	7-1/4
6		9	1/4	6-3/8	8-1/2
8		11-5/8	1/4	8-1/2	12-3/4

Spare Finishing Rings, Specify Fig. 157-99A.

Spare Wing Nuts for Figs. 157 and 317 4", 5", 6", See Fig. 453 No. 4.  
8" See Fig. 453 No. 5.



Fig. 157

## DECK LIGHTS—Fig. 838

Cast Bronze — Plain Finish — Clear Glass

Diameter Glass Inches	Each	Thickness Glass Inches	O.D. Spigot Inches	Outside Diam. Frame Inches	Length Spigot Inches	Weight Pounds
4		1/4	4-7/8	6	11/16	1-3/4
5		1/4	5-7/16	7-1/2	5/8	2
6		1/4	6-7/8	8-1/4	5/8	2-3/4
*8		1/4	9-1/16	11	1-3/16	5-1/4

\*8 inch size has Tempered Glass.



Fig. 838

## ROUND PORTLIGHT SCREENS—Fig. 442

Brass — Copper Plated — Spring Type

For Figs. 157 & 317 Portlights

For Size Opening Inches	Each	For Size Opening Inches	Each
4		6	
5		8	



Fig. 442

## SCREENS FOR MARINE WINDOWS — Fig. 814

For Figs. 796 & 803

Brass — Plain Chrome Finish

No.	Each	Dimensions Inches	Weight Ounces
1		5 x 12	5
2		7 x 16	7

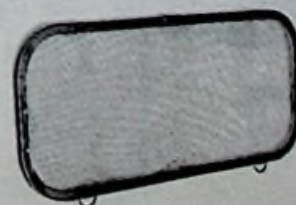

Fig. 814

Fig. 441



### PORTLIGHT CHAINS—Fig. 441

Stainless Steel Chain — Chromium Plated Brass Fittings.

Each	Length Inches	Length Strap Inches	Weight Ounces
	7	17/8	2

Standard Package, 5 Pieces.

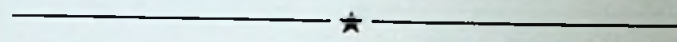

Fig. 461

### VINYL FOR PORTLIGHTS AND WINDOWS—Fig. 461

Size	Per Length
1/4" x 3/8" x 1/2"	.....

Supplied only in 10 foot lengths.

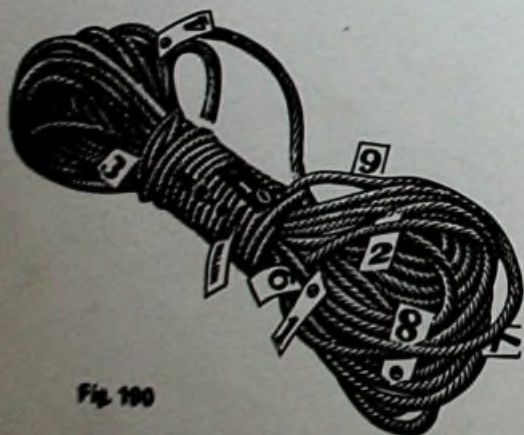

Fig. 190

### "NEPTUNE" MARKED LEAD LINES—Fig. 190

Vinylite Plastic Markers — 5/16 Inch Dacron Line

Instead of the old cryptic markings, this line makes use of colored plastic markers printed with numerals in contrasting colors. These markers are soft and resilient, unaffected by salt, grease, oil and sunlight. The Neptune Line was widely used by the Navy, Army and U.S. Maritime Commission. It is also used by skin divers with a float to mark the depth of a dive.

Length Fathoms	Each	Length Fathoms	Each
7		20	
10		25	
15		30	

NOTE: 7 and 10 fathom lines are marked every fathom and half fathom, the latter indicated by a yellow strip. Longer lines marked according to Navy standard . . . i.e. 2 - 3 - 5 - 7 - 10 - 13 - 15 - 17 - 20 fathoms and every 5 fathoms thereafter.

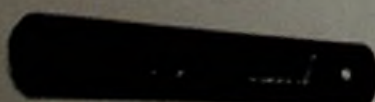
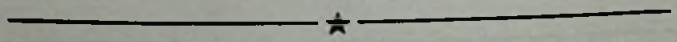

Fig. 940

### SOUNDING LEADS—Fig. 940

All weights from 2 to 10 pounds inclusive carried in stock.

PER POUND —

## ROUND STAINLESS STEEL SINKS – Fig. 391

Deep Drawn, Seamless Construction –  
20 Gauge 18-8 – Polished Finish – Self Rimming

Packed in individual carton.

No.	Each	Diameter Inside Inches	Diameter Outside Rim Inches	Depth Inside Inches	Weight Pounds
6		11-3/4	13-3/4	5	2

Finishing frame not required.  
Drain fitting not included, see Fig. 586.



Fig. 391

## STAINLESS STEEL SINKS – Fig. 392

Deep Drawn, Seamless Construction –  
20 Gauge 18-8 – Satin Finish – Self Rimming

Bottom heavily undercoated for sound deadening.  
Packed in individual carton.

No.	Each	Size Inside Inches	Size Outside Rim Inches	Depth Inside Inches	Weight Pounds
1		10 x 14	13 x 17	7-1/2	7
2		14 x 15	17 x 19	7	6-1/2

Finishing frames not required.  
Drain fitting not included, see Fig. 357.



Fig. 392

## DRAIN FITTINGS – Figs. 357 and 586

Brass – Chromium Plated

Fig. 357 For use with sink Fig. 392

Fig. 586 For use with sink Fig. 391

Fig.	Each	Opening In Sink Inches	Diameter Tall Piece Inches	Weight Ounces
357		3-1/2	1-1/2	20
586		2	1-1/2	10



Fig. 357



Fig. 586

## SEAGOING ASH TRAY—Fig. 795

All Brass – Chromium Plated  
Swing Type – Removable

Each	Dimensions Mounting Plate Inches	Overall Height Inches	Weight Ounces
	1-3/4 x 1-1/4	3	5-3/4

Spare Wall Plate, Specify Fig. 166, Chrome.

Spare Acorn Nut, See Fig. 465 No. 2 .



Fig. 795

## CAN AND GLASS HOLDERS—Fig. 804

Swinging Type – All Brass – Chromium Plated  
Holds 12 ounce cans or straight sided glasses.

Each	Size Mounting Plate Inches	Inside Diam. Ring Inches	Weight Ounces
	1-3/4 x 1-1/4	2-3/4	5

Spare Wall Plate, Specify Fig. 166, Chrome.



Fig. 804



Fig. 420

**CAST BRONZE FOG BELLS—Fig. 420**

Medium Weight — With Removable Bracket

Bottom Diameter Inches	Polished Bronze Each	Chromium Plated Each	Height Overall Inches	Weight Pounds
6			5	3-1/4
8			6-1/8	6-1/2



Fig. 150

**CAST BRONZE FOG BELLS—Fig. 150**

Heavy Weight — With Removable Bracket

Bottom Diameter Inches	Polished Bronze Each	Chromium Plated Each	Height Overall Inches	Weight Pounds
8			8	9
10			10-1/2	16-1/2
12			12	31



Fig. 158

**CAST BRONZE SHIP BELL — Fig. 158**

Heavy Weight — With Stationary Bracket

Bottom Diameter Inches	Polished Bronze Each	Chromium Plated Each	Height Overall Inches	Weight Pounds
12			12	31
14			13	35-1/2

**SPARE PARTS**

SPECIFY SPARE PART NO., SIZE and FINISH

ARMS		WALL PLATES		CLAPPERS		EYE BOLTS		ACORN NUTS	
Figure No.	Spare Part No.	Figure No.	Spare Part No.	Figure No.	Spare Part No.	Figure No.	Spare Part No.	Figure No.	Spare Part No.
420-6"	420-99A-6"	420-6"	127	420-6"	153	420-6"	113	420-6"	465 NO. 4
420-8"	171	420-8"	127	420-8"	144	420-8"	123	420-8"	465 NO. 8
150-8"	171	150-8"	127	150-8"	144	150-8"	123	150-8"	465 NO. 8
150-10"	150-99A-10"	150-10"	150-99B-10"	150-10"	150-99C	150-10"	150-99D	150-10"	465 NO. 9
150-12"	150-99A-12"	150-12"	150-99B-12"	*150-12"	172	*150-12"	172	150-12"	465 NO. 9
*158-12"	158-99A-12"	*158-12"	158-99A-12"	*158-12"	172	*158-12"	172	158-12"	465 NO. 9
*158-14"	158-99A-14"	*158-14"	158-99A-14"	*158-14"	172	*158-14"	172	158-14"	465 NO. 9

\*Includes Wall Bracket

\*Includes Arm

\*Includes Eye Bolt

\*Includes Clapper



## BRASS FOG BELLS -- Fig. 159

With Removable Arm and Wall Plate  
Clapper has short arm for Lanyard.

Bottom Diameter Inches	Plain Brass Each	Polished Brass Each	Chromium Plated Each	Height Overall Inches	Weight Pounds
6				4	1
8				5	2-1/4

### SPARE PARTS -- SPECIFY FINISH

	Plain Each	Polished Each	Chrome Each
Arm Only, Fig. 159-99 A			
6" Clapper Only, Fig. 159-99 B			
8" Clapper Only, Fig. 153			
Eye Bolt Only, Fig. 113			
Wall Plate Only, Fig. 166			
Acorn Nut Only, Specify Fig. 465 No. 4			



Fig. 159

## SKIN PACK -- Fig. 159-SP

6 Inch -- Chromium Plated  
One Bell Per Card.  
Two Cards Per Box.  
Weight Per Box, 2 3/4 Pounds.  
Sold To Trade In Full Box Only



Fig. 159-SP

## FOG HORNS--Fig. 162

Aluminum -- Durable White Baked Enamel Finish --  
Nylon Mouthpiece  
Lightweight Fog Horn that is attractive and practical

Each	Length Overall Inches	Weight Ounces
	12-1/2	6

IMPROVED

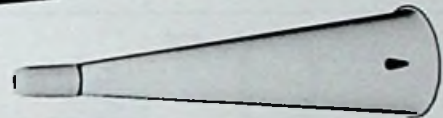

Fig. 162

## TRIPLEX MOTOR BOAT WHISTLE--Fig. 167

Plastic

Each	Length Overall Inches	Width Overall Inches	Weight Per Dozen Pounds
	6	1-3/4	1

Standard Package, 10 Pieces.

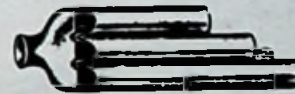

Fig. 167

## SKIN PACK -- Fig. 167-SP

One Whistle Per Card.  
Twelve Cards Per Box,  
Weight Per Box, 1 1/2 Pounds.  
Sold To Trade In Full Box Only.



Fig. 167-SP

## SIGNAL WHISTLE--Fig. 349

Black Plastic

Each	Length Inches	Width Inches	Weight Per Dozen Ounces
	2-1/4	3/4	8



Fig. 349

Standard Package, 10 Pieces.

### COURSE PROTRACTOR – Fig. 706

Indicates Course and Reverse Course – Transparent

A precision instrument that is accurate in detail. Positions, depths etc. are clearly visible through protractor. The arm has various mileage scales used on all coastal and harbor charts. It extends on short end to show reverse course.

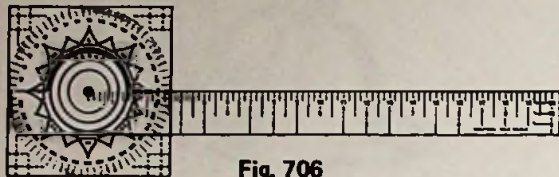

Fig. 706

Each	Extreme Length Inches	Diam. Compass Card Inches
	21-1/2	6-3/8



### LUCITE PARALLEL RULES—Fig. 630

Transparent – Aluminum Bars – Heavy Type

Chart data shows clearly through transparent lucite. Heavy type with finger grips, and corprene non-sliding discs.

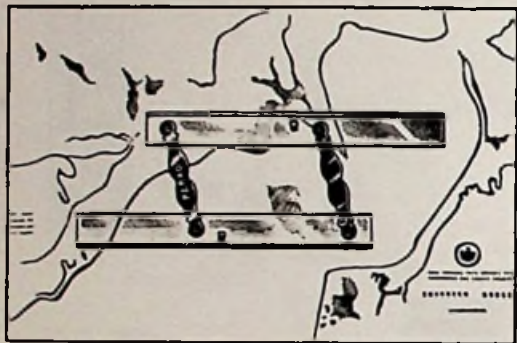

Fig. 630

Length Closed Inches	Each	Width Closed Inches	Thickness Inches	Weight Ounces
12		2-1/2	3/16	6-1/2
15		2-1/2	3/16	7-1/2
18		2-1/2	3/16	8-1/2



### DIVIDERS—Fig. 693

Brass – Chromium Plated – Navy Type



Fig. 693

No.	Each
1 Length, 5-1/2 inches	
2 Length, 7 inches	

No. 2 size has straightening device and reversible points.  
Standard Package, 5 Pieces.



### YACHT LOG BOOK—Fig. 708

112 Pages – Water Resistant Binding

Cover is hard plastic coated Kivar. Water resistant and washable. Navy blue with gold lettering. In addition to pages for log data, these books contain useful information such as extracts from Bowditch Practical Navigator on symbols for weather, state of sea, cloud formations, force of wind, guest log and marine telephone log.

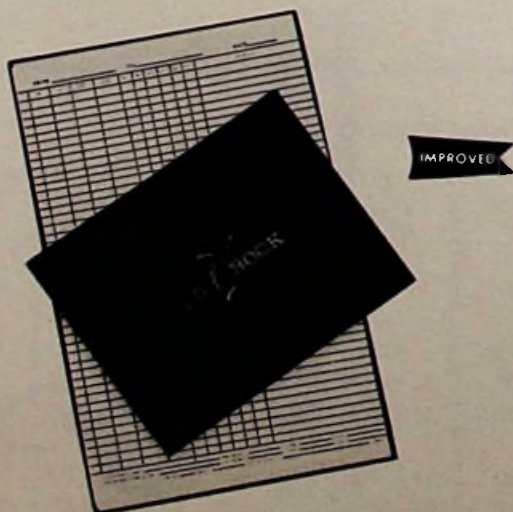

Fig. 708

Weight, 20 Ounces

Each

**PERKO®**

**steering equipment**

**shaft fittings**

**thru hulls**

**water strainers**

**fuel filters**

**underwater fittings**

**pumps, drainers**

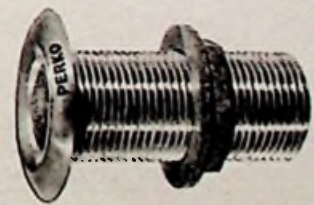
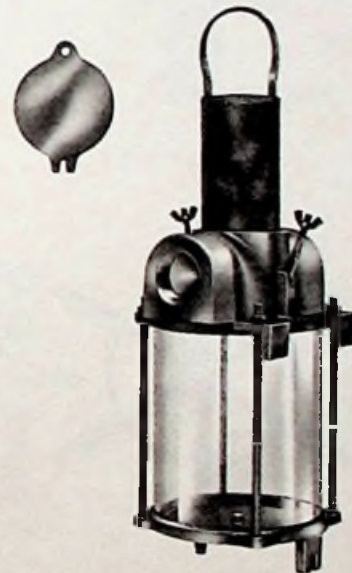

MANUFACTURED BY PERKO, INC., 16490 N.W. 13TH AVE., P.O. BOX 64000-D, MIAMI, FLORIDA 33164

FOR COMPLETE LINE SEE CATALOG NO. 230



## HYSPEED RUDDERS— Fig. 818

Cast Manganese Bronze

Constructed in perfectly balanced proportion. Designed for express cruisers, runabouts, speedboats and all boats not carrying a skag

No.	Each	Dimension Inches				Weight Pounds
		A	B	C	D	
5		9	12	1	16	13
6		10-1/2	14	1-1/8	18	17
7		12	16	1-1/4	18	23

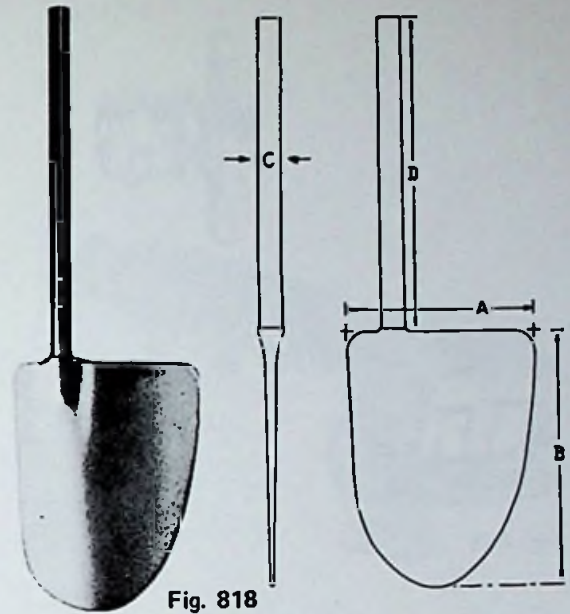

Fig. 818

## RUDDER STUFFING BOXES—Fig. 1088

Cast Bronze — Plain — With Square Flange — Four Bolt Holes

No.	For Diam. Stock Inches	Each	Size Flange Inches	Overall Length Bearing Inches	Drilled For Fastening Inches	Weight Pounds
5	1		3-3/4x3-3/4	5-1/4	3/8	3
6	1-1/8		3-3/4x3-3/4	5-5/8	3/8	3-1/2
7	1-1/4		3-3/4x3-3/4	6-1/4	3/8	4



Fig. 1088

## RUDDER STUFFING BOXES—Fig. 1089

Cast Bronze - Plain — With Oval Flange — Two Bolt Holes

No.	For Diam. Stock Inches	Each	Size Flange Inches	Length Bearing Inches	Drilled for Fastening Inches	Weight Pounds
4	7/8		4-1/4x2-1/4	5-3/8	3/8	3-1/4
5	1		4-1/4x2-1/4	5-3/8	3/8	3-1/4
6	1-1/8		5 x2-5/8	5-1/4	1/2	3-3/4
7	1-1/4		5-3/4x3	6-3/8	1/2	5-1/2
8	1-3/8		6-1/4x3-1/4	6-3/4	1/2	6-1/2
9	1-1/2		6-1/2x3-1/2	6-3/4	1/2	6-3/4

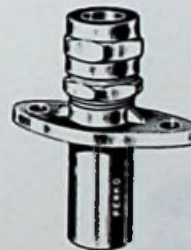

Fig. 1089

## BRONZE COLLARS—Fig. 815

No.	For Diam. Stock Inches	Each	Outside Diameter Inches	Thickness Inches	Weight Ounces
5	1		1-3/4	15/16	7
6	1-1/8		1-3/4	15/16	6-1/2
7	1-1/4		2-1/8	15/16	11
8	1-3/8		2-1/2	1-1/8	19
9	1-1/2		2-1/2	1-1/8	19



Fig. 815



Fig. 320

**STUFFING BOXES—Fig. 320**  
Cast Bronze — Regular

No.	Shaft Size Inches	Each	Size Flange Inches	For Diam. Bolt Inches	Length Bearing Inches	Weight Pounds
3	3/4		4 x 1-3/4	3/8	2-1/8	1-1/8
4	7/8		4-1/8x1-7/8	7/16	2-5/8	1-1/2
5	1		4-1/4x2-1/8	7/16	2-5/8	1-3/4
6	1-1/8		4-7/8x2-1/8	1/2	2-7/8	2-1/4
7	1-1/4		5-3/4x2-3/8	1/2	2-7/8	3
8	1-3/8		6-1/4x3	1/2	3	3-1/4
9	1-1/2		6-1/2x3	1/2	3	3-1/2

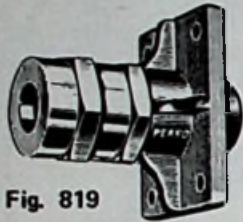

Fig. 819

**EXTRA HEAVY STUFFING BOXES—Fig. 819**  
Rectangular Flange — Cast Bronze

No.	Shaft Size Inches	Each	Size Flange Inches	For Diam. Bolt Inches	Length Bearing Inches	Weight Pounds
7	1-1/4		5-5/8x3-5/8	1/2	4-1/4	6-1/2
8	1-3/8		6 x4	1/2	5	9
9	1-1/2		6 x4-3/8	1/2	5-1/2	10
10	1-3/4		6-1/2x4-1/2	5/8	7	13-1/2
11	2		7-3/4x5	5/8	7-3/8	15-1/2



Fig. 734

**SELF-ALIGNING STUFFING BOXES—Fig. 734**  
Cast Bronze — Rectangular Flange

No.	For Shaft Inches	Each	Size Flange Inches	Length from Flange to End of Box Inches	Weight Pounds
5	1		5x3-1/4	6-3/4	5
6	1-1/8		6x4-1/4	7-3/4	9
7	1-1/4		6x4-1/4	7-3/4	9-1/2
9	1-1/2		7x4-1/2	8-1/4	13

Note: Length Bearing does not include packing nut or space for packing.

Spare Stuffing Boxes, See Fig. 672.

Spare Hoses, See Fig. 673.

Spare Clamps, See Fig. 6400.



Fig. 73



Fig. 79

**PACKING NUTS AND LOCK NUTS—Figs. 73 & 79**

For Stuffing Boxes — Cast Bronze

No.	Shaft Size Inches	Fig. 73 Each	Fig. 79 Each	Width Hex Inches	For Use With Figures
3	3/4			1-3/8	320
3A	3/4			1-3/4	672 No. 3
4	7/8			1-5/8	320 & 1089
4A	7/8			1-3/4	672 No. 4
5	1			1-3/4	320, 672, 1088, 1089
6	1-1/8			2	320, 672, 1088, 1089
7	1-1/4			2	672
7A	1-1/4			2-1/4	320, 819, 1088, 1089 (Size No.)
8	1-3/8			2-3/8	320, 672, 819, 1089
9	1-1/2			2-3/8	672
9A	1-1/2			2-1/2	320, 819, 1089 (Size No. 9)
10	1-3/4			3-1/4	819
11	2			3-1/2	819



Fig. 6400

**STAINLESS STEEL MARINE HOSE CLAMPS—Fig. 6400**  
No Rivets — Welded

Part Number	Each	Size Hose Inches		Clamp Diameter Inches		Box Quantity	Weight Per 100 in Pounds
		From	To	Min.	Max.		
4		1/4	5/8	3/8	11/16	10	2
10		3/8	5/8	5/8	1-1/16	10	6
12		5/8	3/4	11/16	1-1/4	10	6
16		3/4	1	13/16	1-1/2	10	7
20		1	1-1/4	13/16	1-3/4	10	7
28		1-1/4	1-3/4	1-5/16	2-1/4	10	8
36		1-3/4	2-1/4	1-13/16	2-3/4	10	9
44		2-1/4	2-3/4	2-5/16	3-1/4	10	9
52		3	3-1/4	2-13/16	3-3/4	10	11
56		3-1/4	3-1/2	3-1/16	4	10	11
64		3-1/2	4	3-9/16	4-1/2	10	12

Note — Above clamps are 1/2 inch wide except Size No. 4 which is 5/16 inch.

## SELF ALIGNING SHAFT LOGS—Fig. 671

Cast Bronze

No.	Each	Size Shaft Inches	Size Base Inches	Length Overall Inches	Degrees of Angle	Weight Pounds
3		3/4	11-3/8x3-1/2	18	12	5-1/4
5	1		11-3/8x3-1/2	18	12	5-1/4
6		1-1/8	16-1/2x4-1/4	23-1/2	10	10-1/4
7		1-1/4	16-1/2x4-1/4	23-1/2	10	10-1/4
8		1-3/8	19x5	28	10	17-3/4
9		1-1/2	19x5	28	10	17-3/4



Fig. 671

NOTE — Size Nos. 3&5 are drilled for screws. Balance of sizes are spotted but not drilled.



## STUFFING BOX AND EXTRA HOSE

Figs. 672, 673 For Self Aligning Shaft Logs

For Log No.	Size Shaft Inches	Fig. 672 Stuffing Box Each	Fig. 673 Hose Each	I.D. Hose Inches	Length Hose Inches
3	3/4			1-3/4	4
4	7/8			1-3/4	4
5	1			1-3/4	4
6	1-1/8			2-3/8	5
7	1-1/4			2-3/8	5
8	1-3/8			2-5/8	5
9	1-1/2			2-5/8	5



Fig. 672



Fig. 673

For Hose Clamps, See Fig. 6400.



## UNIVERSAL STRUTS—Fig. 1055

Cast Manganese Bronze — For Cutless Rubber Bearings

These struts can be made any length shorter than standard by sliding the shank up through the base to the required length. The necessary angle for the shaft is also obtained in the same way.

Two Everdur Hex Head Bolts are furnished. Extreme drop to center of shaft is 7 inches. Base drilled for 5/16 inch bolts. Dimensions of base 5-3/8 x 3-1/8 inches.

No.	Each	For Diam. Shaft Inches	For Cutless Bearing Code	Length Bearing Inches	Weight Pounds
3		3/4	Kale	3-1/2	6
5		1	Kayak	4	7-1/2
6		1-1/8	Kersey	4-1/2	7-1/2
7		1-1/4	Kidnap	5	7-1/2

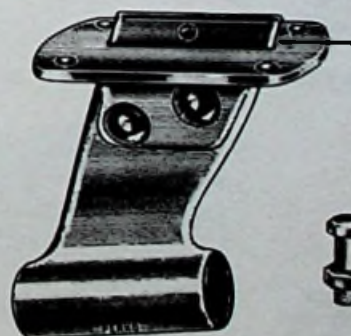

Fig. 1055

CUT  
OFF  
HERE



**PIPE DECK PLATES**

Cast Bronze – Straight Pipe Threads  
 Size Nos. 7 and 8 are Slotted per Illustration.  
 Other Sizes have Holes for Key, Not Slotted.

Marked Type is Marked on the Plate,  
 Not on the Cap.

Caps have Rubber "O" Ring for Water Tightness  
 Complete with Key

**UNMARKED – Fig. 528**



Fig. 528

No.	Pipe Size Inches	Machine Finish Complete Each	Polished Chromium Plated Complete Each	Outside Diam. Plate Inches	Weight Pounds
5	3/4			2-5/8	1/2
6	1			2-7/8	5/8
7	1-1/4			3-5/16	7/8
8	1-1/2			3-5/8	1
9	2			4-1/4	1-1/2
10	2-1/2			4-5/8	2
11	3			5-3/8	2-1/2



Fig. 528-G

**MARKED "GAS" – Fig. 528-G**

No.	Pipe Size Inches	Machine Finish Complete Each	Polished Chromium Plated Complete Each	Outside Diam. Plate Inches	Weight Pounds
7	1-1/4			3-5/16	7/8
8	1-1/2			3-5/8	1
9	2			4-1/4	1-1/2



Fig. 528-D

**MARKED "DIESEL" – Fig. 528-D**

No.	Pipe Size Inches	Machine Finish Complete Each	Polished Chromium Plated Complete Each	Outside Diam. Plate Inches	Weight Pounds
7	1-1/4			3-5/16	7/8
8	1-1/2			3-5/8	1
9	2			4-1/4	1-1/2

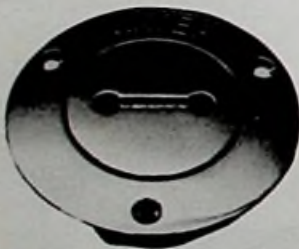

Fig. 528-W

**MARKED "WATER" – Fig. 528-W**

No.	Pipe Size Inches	Machine Finish Complete Each	Polished Chromium Plated Complete Each	Outside Diam. Plate Inches	Weight Pounds
7	1-1/4			3-5/16	7/8
8	1-1/2			3-5/8	1
9	2			4-1/4	1-1/2

**SPARE PARTS FOR ABOVE DECK PLATES**

Spare Caps, Specify Fig. 528, 99A Size and Finish.

Spare "O" Ring, Specify Fig. 528, 99B and Size.

Spare Keys, Sizes 5 to 10, Specify Fig. 1248, and Size.

Size 11, Specify Fig. 827.

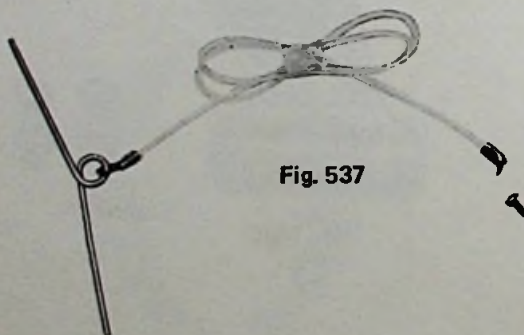

Fig. 537

**SAFETY CORDS – Fig. 537**

**For PIPE DECK PLATES**

The Caps of All the Above Deck Plates  
 Are Pre-Drilled and Tapped for this Cord.  
 Cord is High Strength Monofilament, 24 Inches  
 Long. Each

Standard Package, 5 Pieces.



## "CHROMALEX"<sup>®</sup> GAS FILL – Fig. 1313

Die Cast Zinc Alloy Body – Chromium Plated

Black Plastic Flange and Cap, Impervious to Gasoline

Improved Floating Cap eliminates the need for a safety chain. Cap is equipped with a Rubber "O" Ring, to assure water tightness of fill. Neck has bead for improved hose retention.

Designed to meet the requirements of U.S.C.G. Safety Standards, January 31, 1977, for Gasoline Fuel Systems.

Each	Diameter Overall Inches	Length Hose Neck Inches	For Hose Size Inches	For Screw No.	OEM Package	Weight Ounces
	3-1/8	1-5/8	1-1/2	7	50	7

Spare Cap, Specify Fig. 1313, 99A

See Section "M" For Our New "CHROMALEX"<sup>®</sup> III Gas Fill.



Fig. 1313



## SKIN PACK – Fig. 1313-SP

One Fill Per Card.

Six Cards Per Box.

Weight Per Box, 3½ Pounds.

Sold To Trade In Full Box Only.

See Section "L" For Our New "CHROMALEX"<sup>®</sup> III Skin Pack Gas Fill.



Fig. 1313-SP

## GAS TANK CAP—Fig. 1245

Die Cast Zinc Alloy – Chromium Plated

Complete with Deck Flange and 24 Inch Safety Cord.

Each	Threaded for Pipe Inches	Height Overall Inches	Diam. Deck Flange Inches	For Screw No.	Weight Ounces
	1-1/2	1-1/8	3-1/8	7	9-1/2

Spare Caps with Safety Cord, Specify Fig. 1245-99A.

Standard Package, 5 Pieces.



Fig. 1245

## "WASTE" FITTINGS – Fig. 524

FOR USE IN EMPTYING HOLDING TANKS

Pressure Cast Bronze – Chromium Plated

With Rubber "O" Ring – Airtight – Complete with Key.

Complies with adopted standard on "Fittings" A.B.Y.C. recommended practices and standards covering sewage holding and/or treatment devices for marine toilet waste.

Each	Straight Pipe Thread Inches	Outside Diam. Plate Inches	Weight Pounds
	1-1/2	3-5/8	1

Spare Caps, Specify Fig. 524-99A.

Spare "O" Rings, Specify Fig. 528-99B Size No. 8.

Spare Keys, See Fig. 1248—Size No. 7-8



Fig. 524

## DECK PLATES FOR HOSE – Fig. 1270

Die Cast Zinc Alloy – Chromium Plated Neck Has Bead

For Improved Hose Retention – Cap Has Rubber "O" Ring.

Cap Has Holes and Slot for Key, Screw Driver or Large Coin.

Complete with Key.

Designed to meet the Requirements of U.S.C.G. Safety Standards.

Fig. 1270 No. 1 marked "WASTE"

Fig. 1270 No. 1B marked "GAS"

Fig. 1270 No. 1C marked "WATER"

No.	Each	Inside Diameter Neck Inches	For Hose Inches	Length Neck Inches	Diameter Flange Inches	Weight Ounces
1		1-3/8	1-1/2	2-3/4	3-1/4	14

NOTE - Figs. 1270 B and C Supplied with Safety Cord.

Spare Caps, Specify Fig. 1270 – 99A and Marking.

Spare Keys, See Fig. 1248, Size No. 7-8

Spare "O" Rings, Specify Fig. 528-99B Size No. 8



Fig. 1270





Fig. 526

**REGULAR DECK PLATES—Fig. 526**

Cast Bronze — With Key

Diam. Opening Inches	Machine Finish Complete Each	Polished Chromium Plated Complete Each	Keys Only Each	Outside Diam. Plate Inches	Weight Pounds
3				4-7/8	1-1/2
4				5-3/4	2
5				7-1/16	2-3/4
6				8-1/4	5
8				10-1/4	7

Keys Only, Specify Fig. 539 and Size.

Spare Caps, Specify Fig. 526, 99A Size and Finish.

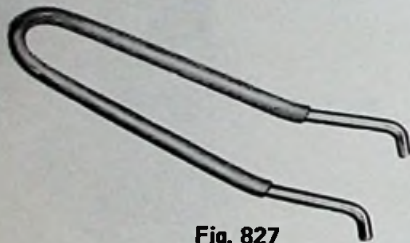

Fig. 827

**DECK PLATE KEY—Fig. 827**

Aluminum — Gold Anodized

Will fit various sizes of deck plates up to 3 inches.

Each	Length Overall Inches	Diameter Metal Inches	Standard Package	Weight Ounces
	5-3/4	3/16	10	1-3/4



Fig. 827-SP



**SKIN PACK — Fig. 827-SP**

One Key Per Card.

Six Cards Per Box.

Weight Per Box, 1½ Pounds.

Sold To Trade In Full Box Only.

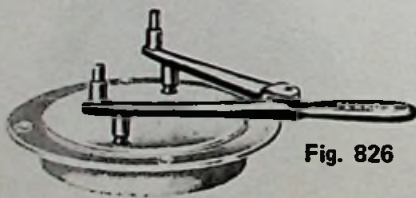

Fig. 826

**DECK PLATE KEY—Fig. 826**

Cast Bronze — Adjustable to all

Sizes of Deck Plates — Heavy Duty

Will fit all sizes of deck plates up to 8 inch diameter.

Each	Length Overall Inches	Standard Package	Weight Pounds
	8-1/2	5	1



**DECK PLATE KEYS — Fig. 1248**

Die Cast Zinc Alloy — Natural Finish

*No.	Each	C to C Of Lugs Inches	Length Overall Inches	Weight Ounces
5-6		5/8	3-3/8	2
7-8		1-1/8	3-3/8	2
9		1-11/16	4-3/8	2-1/2
10		2	4-3/8	2-1/2



Fig. 1248

\*Corresponds with Size of Deck Plate.

## CHOKE CONTROL HANDLES – Fig. 692

For Casing With Left Hand Lay – All Brass – Chromium Plated – With Phosphor Bronze Spring – Friction Device

Has An Adjustable Friction Device to Hold At Desired Setting.

Control wire and casing can be easily attached. No soldering necessary, wire held by set screw in knob. Casing threaded into tube. For use on a dash or bulkhead up to 2 inches thick.



Fig. 692

Each	Length Inches	Diam. Stem Inches	Standard Package	Weight Ounces
	4-7/8	3/8	5	2



## BOWDEN WIRE AND CASING—Fig. 353

Brass – 1/4 Inch O.D. Casing – Left Hand Lay – Wire Diameter .072 Inches

### 50 FOOT LENGTHS ONLY

No. 1 ..... Casing only per length  
 No. 2 ..... Wire only, per length

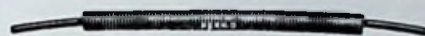

Fig. 353



## BOWDEN CASING CLAMP—Fig. 352

Brass – Swivel Type – Plain

Will hold control casing firmly while swivel feature allows smooth sliding of control wire in casing at any angle.

Each	Size Base Inches	Standard Package	Weight Ounces
	2-1/4x1	10	3

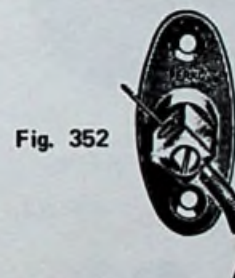

Fig. 352

## STEERER AND CONTROL PARTS—Fig. 865

Cast Bronze – Plain

No.	Item	Each	Length Overall Inches	Length C to C Inches	Weight Pounds
1	Lever		8	6	1-3/4
1-A	Lever		10	6-7-8*	2-1/8
1-B	Lever		10	6-7-8*	2-1/4
1-C	Lever		10	6-7-8*	2-1/4
2	Clevis		2-1/2		1/2
2-A	Clevis		2-1/2		1/2
2-B	Clevis		4-1/16		3/4
2-C	Clevis		4-1/16		3/4
8	Bearing				3/4



1. Lever

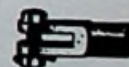

2. Clevis

No.	For Diam. Shaft Inches	For Diam. Pin Inches	Diam. Bolt Inches	Tapped For Rod Inches	Tapped For Pipe Inches	Inside Jaw Inches	Diam. Flange Inches
1	1	1/2					
1-A	1	1/2					
1-B	1-1/8	1/2					
1-C	1-1/4	1/2					
2			1/2	3/4		1/2	
2-A			1/2		1/2	1/2	
2-B			1/2		3/4	9/16	
2-C			1/2	1		9/16	
8	1						3-1/2



8. Lower Bearing

Depth of Bearing – No. 8, 5/8 Inches.

\*Nos. 1-A, 1-B, 1-C Are Of Heavy Construction Like No. 1, And With Three Pin Holes.

Fig. 865



Fig. 252

**ELECTROLYSIS COLLARS—Fig. 252  
FOR SHAFT**

Streamlined Zinc Die Casting — Precision Made And Balanced —

The electrolysis collar is the least expensive way of protecting the most expensive parts of any boat against electrolytic action. It is a precision made collar of zinc designed to fit properly on any propeller shaft regardless of the shaft R.P.M. These collars can be easily and almost instantly installed by anyone. They are doweled, so the two halves will always locate themselves. These collars help to protect vital underwater fittings such as propellers, struts, shafts, strut bolts, also prevent pitting of all underwater fastenings.

Sizes No. 3 thru 7 have 2 bolts, larger sizes 4 bolts.

No.	Each	Shaft Size Inches	Length Overall Inches	Standard Package	Bulk Package	Weight Pounds
3		3/4	2	10	25	3/4
4		7/8	2	10	25	3/4
5		1	2-1/4	10	50	1-1/8
6		1-1/8	2-1/4	10	50	1-1/8
7		1-1/4	2-1/4	10	50	1-1/8
8		1-3/8	2-3/4	10	50	1-3/8
9		1-1/2	2-3/4	10	50	1-3/8
10		1-3/4	2-7/8	5	25	2-1/2
11		2	2-7/8	5	25	2-1/2



Fig. 253

**ELECTROLYSIS COLLARS—Fig. 253  
FOR SHAFT**

Zinc Die Castings — Heavy Duty Commercial Type —

No.	Each	Shaft Size Inches	Length Overall Inches	Diam. Overall Inches	Weight Pounds
11		2	1-1/8	3-3/4	1-1/2
12		2-1/4	1-1/8	3-3/4	1-1/2
13		2-1/2	1-5/8	5	3-1/2
14		3	1-5/8	5	3
15		3-1/2	1-11/16	6	6
16		4	1-11/16	6	5



Fig. 407

**ELECTROLYSIS ELIMINATORS—Fig. 407  
FOR RUDDERS**

Smooth Zinc Die Castings —

No.	Per Set as Illustrated	Diameter Inches	Standard Package	Bulk Package	Length Bolt Inches	Weight Complete Pounds
2		2-7/8	10	50	2	1
2-A		3-3/4	5	25	2	1-3/4
3		5	5	25	2	3



Fig. 244

**ELECTROLYSIS ELIMINATORS—Fig. 244  
FOR SMALL BOAT HULLS**

Zinc Die Castings

No.	Each	Length Inches	Width Inches	Standard Package	Bulk Package	Weight
1		3-1/2	1-3/4	10	100	6-1/2 oz.
2		5-1/4	2-1/8	10	50	1-1/4 lb.

## ELECTROLYSIS ELIMINATORS—Fig. 247 FOR SMALL BOAT HULLS

Die Cast Zinc

Each	Length Inches	Width Inches	Standard Package	Bulk Package	Weight Ounces
	4-3/4	2	10	50	14



Fig. 247

## ELECTROLYSIS ELIMINATORS – Fig. 241 FOR YACHT HULLS

Die Cast Zinc

Each	Length Inches	Width Inches	Thickness Inches	Standard Package	Bulk Package	Weight Pounds
	9-1/4	3-3/8	3/4	5	25	3-1/4



Fig. 241

## ELECTROLYSIS ELIMINATORS—Fig. 345 FOR COMMERCIAL HULLS

Die Cast Zinc

Each	Length Inches	Width Inches	Thickness Inches	Standard Package	Bulk Package	Weight Pounds
	6-1/4	2-3/4	5/8	5	25	2-1/4



Fig. 345

## ELECTROLYSIS ELIMINATORS—Fig. 254 FOR MARINE ENGINES

Zinc With Forged Bronze Plug

No.	Complete Each	Plug I.P.S. Inches	Zinc Dimensions Inches	Weight Ounces
3		3/8	3/8x1-3/4	2
4		1/2	5/8x2	4-1/2
5		3/4	3/4x2	7
5A		3/4	3/4x3-1/4	8-1/2

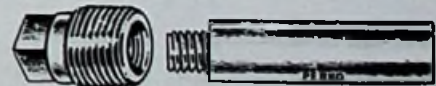

Fig. 254

Spare Zincs, Specify Fig. 254-99 A And Size

Spare Bronze Plugs, Specify Fig. 254-99 B And Size

Standard Package, 5 Pieces Per Size.

ALL ABOVE ZINCS IN STANDARD OR BULK PACKAGES ONLY. NO BROKEN PACKAGES.

**FUEL FILTER AND SEPARATOR**

FIG. 299

**Cast Bronze – With “Kwick Klean” Filter Element**

**For Gasoline – Diesel Fuel – Lubricating Oil – Air – Water**

Designed To Comply With U.S.C.G. Standards For Fuel Filters And Strainers.\*

These units are guaranteed to separate water from gasoline or diesel fuel. The filter element is a 40 micron microcarbon ribbon type made of cellulose and impregnated with phenolic resin. It has a high rate of flow sufficient to feed high horsepower diesel and gasoline engines. Easily cleaned by reverse flow or back flushing with compressed air.

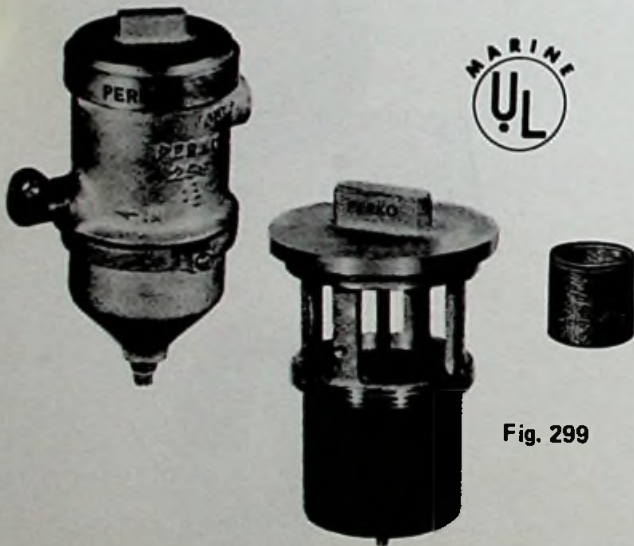

Fig. 299

Cast Bronze Housing and Adjustable Mounting Bracket – Drain Plug – Viton “O” Ring Gasket.

Tested and accepted for labeling and listed by the Underwriters Laboratories Inc.

Size No.	Complete Each	Length Overall Inches	Diam. Inches	**Tapped For Pipe Inches	Weight Pounds
1		5-1/2	2-3/8	1/4 & 3/8	3-3/4
1-1/2		6-1/4	3-1/8	3/8 & 1/2	5-1/2

No. 1 Element is 1-3/4" O.D. x 1-3/4 long.

No. 1-1/2 Element is 2-1/4" O.D. x 2" long.

\*\*Casting is tapped for larger size with removable bushing for smaller size.

**KEEP IT CLEAN WITH AN APPROVED FILTER**

There are three classifications for fuel cleaning devices:

**Filters**, which remove particles of microscopic size (40 microns or less)

**Strainers**, which remove larger particles (More than 40 but less than 150 microns)

**Separators**, which effectively remove water from the fuel.

**SPARE PARTS**

Spare elements, Specify Fig. 324 and Size No.

Spare “O” Rings, Specify Fig. 327 and Size No.

\*U. S. Coast Guard Safety Standards For Gasoline Fuel Systems, January 31, 1977.

## INTAKE WATER STRAINERS

FIGS. 493 AND 500

Perko water strainers are designed for easier installation and cleaning. Also, the outside tie rod safety feature eliminates the electrolysis problems often encountered with designs using internal tie rods.

Tested and accepted for labeling and listed by the Underwriter's Laboratories, Inc.

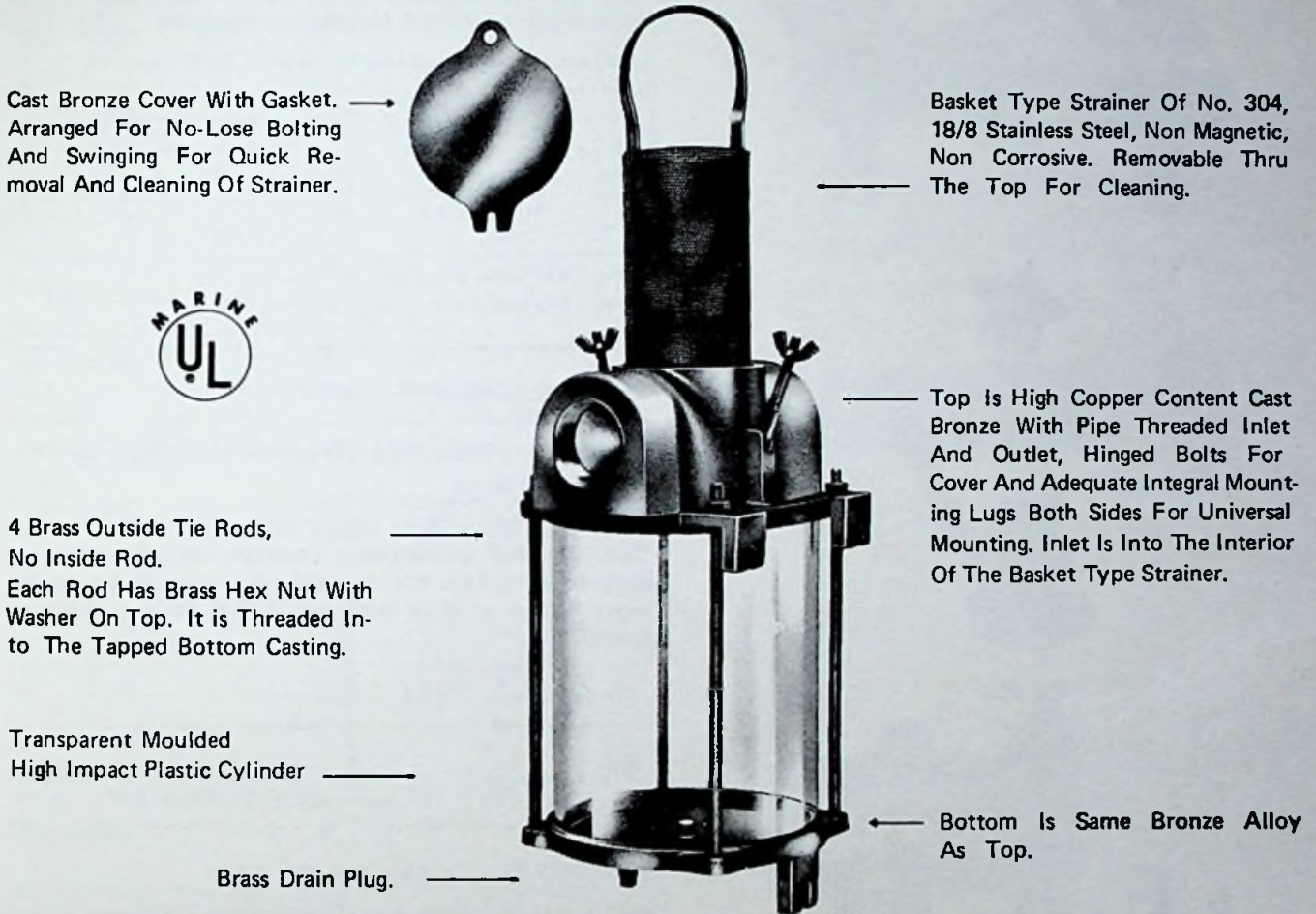

Fig. 493 - STANDARD TYPE

No.	Complete Each	Pipe Size Inches	Size Cylinder Inches	Approx. Height Inches	Approx. Width Overall Inches	Approx. Weight Pounds
3		3/8	2-1/2x2-3/4	4-1/4	3-1/4	2-1/2
4		1/2	3-1/2x4	5-3/4	4-1/2	5
5		3/4	3-1/2x6	8-3/8	4-1/2	5
6		1	4-1/2x5-1/2	9-1/2	5-1/2	8
7		1-1/4	4-1/2x6	10	5-1/2	8
8		1-1/2	6 x8	11-1/2	7	14
9		2	6 x12	16	7-1/4	18
10		2-1/2	6 x12	16	7-1/2	18

Fig. 500 - HEAVY DUTY TYPE

High Capacity For Diesels And Large Gasoline Engines

9	2	8x10	14-1/2	9-1/4	34
10	2-1/2	8x12	16-1/2	9	34
11	3	8x14	20-1/2	9	34

### SPARE PARTS

SPECIFY FIG. NO. OF STRAINER, SIZE AND PART NO. BELOW.

Top Casting	99-A	Basket Strainer	99-D	Tie Rod	99-G	Wing Nut And Washer For Cover	99-K
Bottom Casting	99-B	Cover	99-E	Nut And Washer For Tie Rod	99-H	Hinged Bolt For Cover With Pin, Nut And Washer	99-L
Transparent Cylinder	99-C	Cover Gasket	99-F	Cylinder Gasket	99-J		



**NEW SEACOCKS – Figs. 834 & 835**

Cast Bronze with Drain Plugs, Thru Hull and Tail Piece

Fig. 834 with 90 degree curved tail piece.

Fig. 835 with straight tail piece.

These sturdy units are of a ball valve design with bronze chromium plated ball to reduce wear and costly time consuming maintenance. They are equipped with Teflon® seats for smooth operation, quick and positive opening or closing and to assure a tight seal. Handles are removable.

Tested and accepted for labeling and listed by the Underwriters Laboratories Inc.



Fig. 834



Fig. 835



No.	Pipe Size Inches	Fig. 834 Each	Fig. 835 Each	Hose Size Inches	Complete Weight Pounds
5	3/4			3/4	3
6	1			1	4-3/4
7	1-1/4			1-1/4	7-1/2
8	1-1/2			1-1/2	10

Spare Tail Pieces, See Figs. - 63 and 76.

Spare Thru-Hull Connections, See Fig. 322



**NEW SEACOCK BODY – Fig. 805**

Complete with Drain Plugs, 4 Pre-drilled Mounting Holes and Bonding Screw.

Some installations may require extra long, scoop type or flush thru hull connections. Therefore we offer the valve body used for Figs. 834 and 835. You may select from our many fittings on pages H-15 and H-17 to fit your individual needs.



Fig. 805

No.	Pipe Size Inches	Each	Weight Pounds
5	3/4		2-1/2
6	1		4
7	1-1/4		6
8	1-1/2		8



**ECONOMY SEACOCKS – Figs. 821 & 823**

Cast Bronze With Drain Plug, Thru Hull and Tail Piece.



Fig. 821



Fig. 823

No.	Pipe Size Inches	Fig. 821 Each	Fig. 823 Each	Hose Size Inches	Complete Weight Pounds
4	1/2		N.A.	5/8	7/8
5	3/4			3/4	1-1/2
6	1			1	2-1/2
7	1-1/4			1-1/4	4
8	1-1/2			1-1/2	5-1/4

Spare Tail Pieces, See Adapter, Figs. 76 and 63.

Spare Thru-Hull Connections, See Fig. 322.



**ECONOMY SEACOCK BODY – Fig. 825**

Cast Bronze – Complete with Drain Plug.



Fig. 825



No.	Pipe Size Inches	Each	Weight Pounds
4	1/2		3/4
5	3/4		1
6	1		1-1/2
7	1-1/4		2-1/4
8	1-1/2		3-1/4



## STANDARD

### THRU-HULL CONNECTIONS—Fig. 322

Cast Bronze — Machined Flange

Back Side of Flange is Machined to Fit snugly to Hull and is Grooved to Retain Bedding Compound or Sealant. Neck is Threaded to Approximately 1/8 Inch From Flange.

No.	Pipe Size Inches	Each	Length Neck Inches	Diameter Flange Inches	For Strainer Fig. 86 No.	Weight Pounds
3	3/8		2-1/4	1-1/2	1	1/4
4	1/2		2-1/4	1-5/8	1	3/8
5	3/4		2-1/4	2	2	1/2
6	1		2-1/2	2-1/4	3	5/8
7	1-1/4		3	2-7/8	4	1-1/2
8	1-1/2		3-1/4	3	5	1-3/4
9	2		3-1/2	3-1/2	5	2-3/8
10	2-1/2		3-5/8	4-1/2	6	3-1/4



## EXTRA LONG

### THRU-HULL CONNECTIONS — Fig. 348

Cast Bronze — Machined Flange

Back Side of Flange is Machined to Fit snugly to Hull and is Grooved to Retain Bedding Compound or Sealant. Neck is Threaded to Approximately 1 inch from Flange

No	Pipe Size Inches	Each	Length Neck Inches	Diameter Flange Inches	For Strainer Fig. 86 No.	Weight Pounds
5	3/4		5-1/2	2	2	3/4
6	1		5-1/2	2-1/4	3	1
7	1-1/4		5-1/2	2-7/8	4	2
8	1-1/2		5-1/2	3	5	2-1/4
9	2		5-1/2	3-1/2	5	3
10	2-1/2		5-1/2	4-1/2	6	4



## FLUSH TYPE "NO BULGE"

### THRU HULL CONNECTIONS—Figs. 331 & 361

Cast Bronze

An improved thru hull fitting for all types of boats, but especially appreciated by builders and owners of fibre glass and planked sail boats. Nothing extending beyond hull to cause friction or slow boat down. The ends of these fittings have tapered threads for easy attachment of valves or other pipe fittings.

No.	Pipe Size Inches	Fig. 331 Each	Fig. 361 Each	Length Overall Inches	Inside Diameter Inches	Diameter Flange Inches	Weight Pounds
4	1/2			2-7/16	1/2	2-1/2	3/4
5	3/4			2-3/4	3/4	2-1/2	7/8
6	1			3	1	3	1-1/4
7	1-1/4			3-3/8	1-1/4	3	1-3/4



## INTAKE STRAINERS—Fig. 65

Cast Bronze — Plain

No.	Pipe Size Inches	Each	Length Neck Inches	Dimensions Strainer Inches	Weight Pounds
4	1/2		2-5/8	3 x 4	5/8
5	3/4		2-9/16	3 x 4	7/8
6	1		3	3 x 4	1-1/8
7	1-1/4		3-1/2	3-1/4 x 4-1/4	1-3/4



All Fittings Shown on This Page Have Been Tested and Accepted For Labeling and Listed by the Underwriters Laboratories, Inc.



Fig. 322



Fig. 348

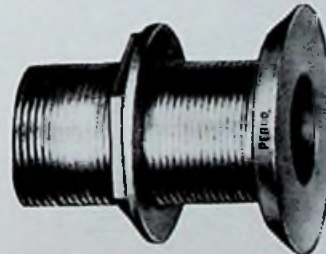

Fig. 331  
Without Strainer

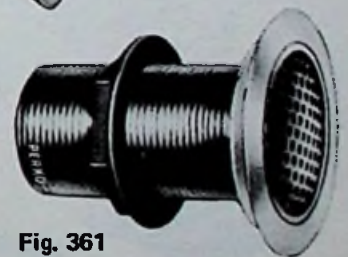

Fig. 361  
With Strainer

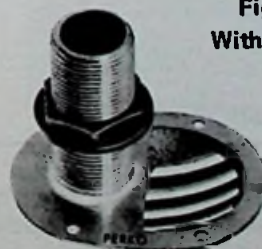

Fig. 65



Fig. 301



Fig. 301-SP

**NEW**

**PLASTIC THRU-HULL CONNECTIONS – Fig. 301**

Durable Plastic – For Use With Hose\*

No.	For Hose Inches	Diam Flange Inches	Weight Ounces	Standard Package	Bulk Package
4	1/2	1-1/2	1	10	100
4A	5/8	1-1/2	1	10	100
5	3/4	1-7/8	1-3/4	10	100
6	1	2-1/4	2-1/4	5	50
8	1-1/2	3	5-1/4	5	50

Spare Flanged Nuts, Specify Fig. 319 and Size.

**SKIN PACK – Fig. 301-SP**

One Connection Per Card

Size	Cards Per Box	Pounds Per Box
4-4A	10	1-1/2
5	8	1-3/4
6-8	6	2-1/2

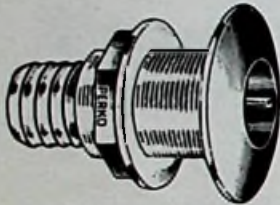

Fig. 350

**THRU-HULL CONNECTIONS – Fig. 350**

Cast Bronze For Use With Hose\* – Backside of Flange is Machined to Fit snugly to Hull and is Grooved to Retain Bedding Compound or Sealant.

No.	For Hose Inches	Plain Each	Polished Chromium Plated Each	Diam. Flange Inches	Maximum Wood Thickness Inches	Weight Pounds
4	5/8			1-5/8	1-1/4	3/8
5	3/4			2	1-5/8	1/2
6	1			2-3/8	1-7/8	7/8
7	1-1/4			3	2	1-3/8
8	1-1/2			3-1/8	2	1-1/2

Spare Flanged Nuts, See Fig. 75.

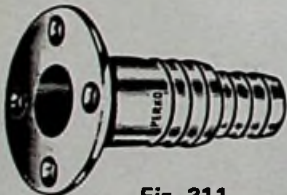

Fig. 311

**THRU-HULL CONNECTIONS – Fig. 311**

Cast Bronze – Chromium Plated – For Use With Hose\*

Each	For Size Hose Inches	Inside Diameter Inches	Length Overall Inches	Diam. Flange Inches	Weight Ounces
	3/4 and 1	9/16	3-1/8	2-1/8	7

\*See ABYC "Safety Standards for Small Craft" Section H-27.3 for recommended usage.



Fig. 66

**SCOOP STRAINERS—Fig. 66**

Cast Bronze

No.	Each	Outside Dimension Inches	For Thru-Hull Size Inches	Weight Pounds
1		3-1/2x2-1/2	1/2	1/4
2		5 x3-1/4	1	3/4
3		6-1/4x4-1/4	1-1/4	1
4		8 x5-1/8	2	2

Standard Package, 5 Pieces.



Fig. 86

**ROUND STRAINERS—Fig. 86**

Cast Bronze

No.	Each	Outside Diam. Inches	Inside Diam. Inches	For Thru-Hull Size Inches	Standard Package	Weight Pounds
1		2-1/2	1-5/8	1/2	5	1/5
2		3	2	3/4	5	1/4
3		3-1/2	2-3/8	1	5	1/3
4		4	3	1-1/4	5	1/3
5		5	3-3/4	2	5	3/4
6		6	4-1/2	2-1/2	1	1
7		8	6-1/4	—	1	2-1/4



All Fittings Shown on This Page Have Been Tested and Accepted For Labeling and Listed by the Underwriters Laboratories Inc.

## PIPE TO HOSE ADAPTER—Fig. 76

### Cast Bronze

No.	Pipe Size Inches	Each	Hose Size Inches	Length Overall Inches	Weight Ounces
4	1/2		5/8	1-5/8	1-1/2
5	3/4		3/4	1-3/4	2-1/8
6	1		1	1-3/4	3-1/2
7	1-1/4		1-1/4	2	5-1/8
8	1-1/2		1-1/2	2-1/4	8-1/8
9	2		2	2-5/8	16



Fig. 76



## PIPE TO HOSE ADAPTER—Fig. 63

### Cast Bronze — Curved — 90 Degrees

No.	Pipe Size Inches	Each	Hose Size Inches	Length Overall Inches	Weight Ounces
5	3/4		3/4	1-3/4	2-1/8
6	1		1	1-3/4	3-1/2
7	1-1/4		1-1/4	2	5-1/8
8	1-1/2		1-1/2	2-1/4	8-1/8



Fig. 63



## FLANGED NUTS—Fig. 75

### Bronze — For Hull Connections

No.	Pipe Size Inches	Each	Standard Package	Weight Ounces
3	3/8		5	1
4	1/2		5	1-1/4
5	3/4		5	2
6	1		5	2-1/2
7	1-1/4		5	6
8	1-1/2		1	6
9	2		1	10
10	2-1/2		1	15



Fig. 75

Size Nos. 3 to 7 inc. are Pressure Cast.  
Balance are Sand Cast.



## EXHAUST FITTING—Fig. 755

### Cast Bronze — With "No Stain" Collar — For Hose

The outside diameter of the neck is for 1-7/8 inch hose which fits over 1-1/2 inch pipe.



Fig. 755

Plain Each	Chrome Plated Each	Length Overall Inches	Inside Diameter Inches	Diameter Flange Inches	Weight Pounds
		3-1/4	1-9/16	3-1/2	1-1/8

**FRESH WATER INLET FITTING – Fig. 499**

Cast Bronze – Chromium Plated

For obtaining fresh water under pressure at dockside. For all types and sizes of vessels but particularly useful on houseboats.

External portion has a swivel hose connector, standard size, with watertight plug and stainless steel bead chain. Internal portion has 1/2 inch female N.P. thread.

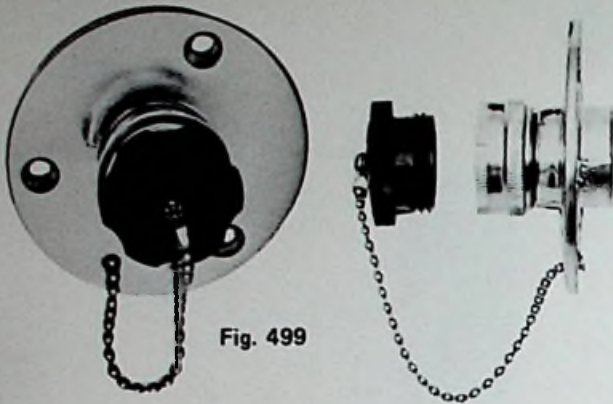

Fig. 499

Each	Diameter Flange Inches	Weight Ounces
	2-3/4	8

Spare Cap with Chain, Specify Fig. 499-99 A.



**WATER OUTLETS—Fig. 332**

Cast Bronze

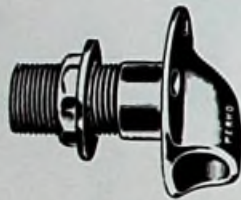

Fig. 332

No.	Pipe Size Inches	Diam. Flange Inches	Length of Neck Inches	Weight Ounces
5	3/4	2-5/8	2-1/4	12
6	1	2-7/8	3-1/4	16

Spare Flanged Nuts, See Fig. 75.



**GALLEY AND LAVATORY PUMP – Fig. 467**

Bronze – Chromium Plated

Inlet Valve Designed to Hold Prime, Pump has Leakproof Neoprene U-Cup Seals



Fig. 467

Chromium Plated Each	Diam. Barrel Inches	Length Neck Inches	Threaded For Pipe Inches	Weight Pounds
	1-1/2	2-1/2	1/2	3-1/2

Spare Handle Only, Specify Fig. 467-99A.  
Repair Kit, Consisting of Rubber Plunger, Seal, Valve, Washer and Spring. Specify Fig. 467-99B.



**ZINC MARINE OILERS—Fig. 326**

Spring Brass Bottom



Fig. 326

Complete Each	Capacity Ounces	Diam. Inches	Length Spout Inches	Weight Per Dozen Pounds
	8	4	4	3-1/2

Standard Package, 10 Pieces. Minimum Quantity.

Spare Spouts, Specify Fig. 326-99 A.

## SMALL BOAT DRAINER – Fig. 386

Threaded Type – Cast Bronze

Install in after end of boat and be sure that mouth is toward the stern. Made for hulls 3/8 inch or thicker but may be used with thinner hulls by cutting away necessary portion of neck. Depth of mouth below hull is 3/4 inch.

Each	Height Inside Boat Inches	Width Overall Inches	Weight Pounds
	2-3/4	2-1/2	1-1/4

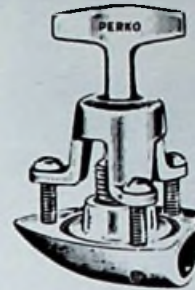

Fig. 386

---

## COCKPIT SCUPPER—Fig. 142

Cast Bronze – With Rubber Ball Back Water Check

Especially needed in sailboats when outlet is below the waterline. With key for removing cap.

Angle of outlet is 45 degrees.

No.	Plain Each	Chromium Plated Each	For Diam. Hose Inches	Diameter Flange Inches	Diameter Grate Inches	Weight Pounds
1			1	3-1/4	1-13/16	1-1/4
2			1-1/2	3-3/4	2-1/4	2

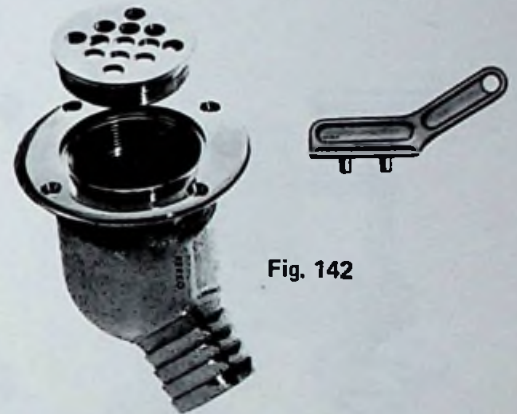

Fig. 142

Spare Caps, Specify Fig. 142-99A Size and Finish  
Spare Ball Checks, Specify Fig. 142-99 B and Size  
Spare Keys, See Fig. 1248 No. 8

---

## JUNIOR STRAINER – Fig. 709

Cast Bronze – For 5/8 Inch Hose

Each	Length Overall Inches	Width Inches	Weight Ounces
	3-5/8	1-3/4	6



Fig. 709

Standard Package, 5 Pieces.

---

## NAVY PUMP STRAINERS

Figs. 704, 705, 721 & 722

Cast Bronze

Fig.	Each	Pipe Thread Inches	For Hose Inches	Length Inches	Width Inches	Weight Pounds
704			1-1/4	7	2-3/4	2
705			1-1/4	4-3/4	2-3/4	1-1/2
721		1-1/4		5	2-3/4	1-1/2
722		1-1/4		4-3/4	2-3/4	1-3/8



Fig. 704

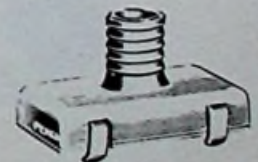

Fig. 705



Fig. 721



Fig. 722



Fig. 414

**TRANSOM DRAIN PLUGS – Fig. 414**  
**Brass – Expanding Plug with Safety Chain**

No.	Complete Each	Diam. Tube Inches	Length Overall Inches	Length Tube Inches	Weight Ounces
1		1	2-1/2	2	4-1/2
2		1	3-1/4	2-3/4	5

Standard Package, 10 Pieces

Spare Plugs with Chain, Specify Fig. 414-99A.  
 Spare Tubes, Specify Fig. 414-99B and Size.



Fig. 414 SP

**SKIN PACK – Fig. 414-SP**

Size No.1  
 One Plug and Tube Per Card,  
 Twelve Cards Per Box,  
 Weight Per Box, 4 Pounds

Sold To Trade In Full Box Only.



Fig. 263



Fig. 363



Fig. 266

**GARBOARD DRAIN PLUGS – Figs. 263, 363 & 266**

Cast Bronze

Figs. 263 and 266

Each	Pipe Size Inches	Diam. Flange Inches	Depth Inches	Weight Ounces
	3/4	2-5/8	5/8	11

Fig. 363

For plywood, fibreglass or metal hulls.

No.	Each	Pipe Size Inches	Diam. Flange Inches	Length Threaded Neck Inches	Max. Hull Thickness Inches	Weight Ounces
2		3/4	2-3/8	1	1/2	14
3		3/4	2-3/8	1-1/4	3/4	14-1/2

Standard Package, 5 Pieces

Spare Plugs, Specify Fig. 370.



Fig. 714 No. 1



Fig. 737 No. 1

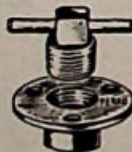

Fig. 714 No. 2



Fig. 737 No. 2

**GARBOARD DRAIN PLUGS – Figs. 714 & 737**

Pressure Cast Silicon Bronze

Figs. 737 No. 1 and 737 No. 2 have extra brass flange and 3 F.H. machine screws, maximum space between flanges is 7/16 inches.

Fig.	No.	Each	Pipe Size Inches	Diam. Flange Inches	Depth Inches	Weight Ounces
714	1		1/2	2	5/8	3
714	2		1/2	2	5/8	4
737	1		1/2	2	5/8	6
737	2		1/2	2	5/8	7

Standard Package, 5 Pieces

Spare Plugs For Figs. 714 and 737

Specify Fig. 742 and Size.

**GARBOARD DRAIN PLUGS – Fig. 124**

Cast Bronze – With Wrench

A few of these drain plugs installed in garboard allows quick drainage of boat when hauled out. Threads are tapered pipe sizes and plugs are watertight.

Each	Pipe Size Inches	Diam. Flange Inches	Depth Inches	Weight Ounces
	1	3-1/8	1	10

Spare Wrench, Specify Fig. 124-99A.

Spare Plugs, Specify Fig. 124-99B.

Standard Package, 5 Pieces



Fig. 124



All Fittings on this page (Except Fig. 414) Have Been Tested and Accepted for Labeling and Listed by the Underwriters Laboratories Inc.

# PERKO<sup>®</sup>

**deck  
equipment**

**cleats & chocks**

**chromalex  
deck fittings**

**bow eyes**

**transom handles  
pulleys, etc.**

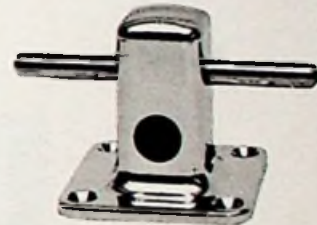

MANUFACTURED BY PERKO, INC., 16490 N.W. 13TH AVE., P.O. BOX 64000-D, MIAMI, FLORIDA 33164

FOR COMPLETE LINE SEE CATALOG NO. 230

**"SLIMLINE" CLEATS – Fig. 1252**



Fig. 1252

Fig. 1252 – Die Cast Zinc Alloy – Chromium Plated

Length Inches	Base Dimensions Inches	For Diam. Rope Inches	For Screw	Standard Package	Weight Ounces
6-1/2	3 x 1-1/8	3/4	1/4"	5	7

Fig. 1252 – Each



**STREAMLINE CLEATS – Fig. 566**

Die Cast Zinc Alloy – Chromium Plated



Fig. 566

Length Inches	Each	Size Base Inches	For Diam. Rope Inches	For Screw No.	Standard Package	Weight Ounces
2		2-3/16x1-1/8	5/16	6	10	1-1/2
3		3-1/8 x1-1/2	3/8	8	10	4-1/2
4-1/2		4-7/16x1-7/8	1/2	10	10	8-1/2
6		5-1/2 x2	3/4	12	5	13-1/2



**SKIN PACK – Fig. 566-SP**



Fig. 566 SP

Length Inches	Units Per Card	Cards Per Box	Weight Per Box Pounds
2	1 Pr.	12 Prs.	3-1/2
3	1 Pr.	12 Prs.	5-1/2
4-1/2	1 Pr.	6 Prs.	8-1/2
6	1 Ea.	12 Pcs.	13

Sold To Trade In Full Box Only



**STURDY CLEATS – Fig. 1204**

Die Cast Zinc Alloy – Chromium Plated



Fig. 1204

Fig. 1204 – With Studs, Nuts and Washers

No.	Fig. 1204 Each	Length Inches	Base Inches	For Rope Inches	Weight Ounces
2		3-1/2	1-3/16x11/16	1/2	3
3		5	1-7/16x1	5/8	6
4		6-1/2	1-3/4 x1-3/16	3/4	9

Fig. 1204 Size No. 2, Stud is 12/24 x 1-1/4.  
 Fig. 1204 Sizes No. 3 and 4, Stud is 1/4/20 x 1-1/4.

Standard Package, 10 Pieces.

O.E.M. Package - Fig. 1204 No. 3, 50 Pieces No. 4, 40 Pieces.



## YACHT CLEATS

Fig. 572 – Cast Bronze – Chromium Plated

Length Inches	Each	For Screw No.	Standard Package	Weight Pounds
4-1/2		10	10	1/2
5-1/2		10	10	5/8
6-1/2		12	10	3/4
*8		1/4"	5	1-1/4
*10		5/16"	1	2
*12		5/16"	1	3

\*These Sizes Are Hollow, Balance Of Sizes Are Solid.



Fig. 572 – Bronze  
Fig. 1188 – Die Cast

Fig. 1188 – Die Cast Zinc Alloy – Chromium Plated

Length Inches	Each	Width Base Inches	For Screw No.	Standard Package	Weight Ounces
4		1-5/8	10	10	3-1/2
6		1-3/4	10	10	7-1/2
8		2	1/4"	5	12

---

## SKIN PACK – Fig. 1188-SP

Length Inches	Units Per Card	Cards Per Box	Weight Per Box Pounds
4	1 Pr.	6 Prs.	5
6	1 Ea.	6 Pcs.	4



Fig. 1188-SP

Sold To Trade In Full Box Only

---

## YACHT CLEATS WITH STUDS – Fig. 1210

Die Cast Zinc Alloy – Chromium Plated

Length Inches	Each	Width of Base Inches	Size Stud	Standard Package	Weight Ounces
4		1-5/8	12-24 x 2	10	4
6		1-3/4	1/4-20 x 2	10	8
8		2	1/4-20 x 2	5	12-1/2

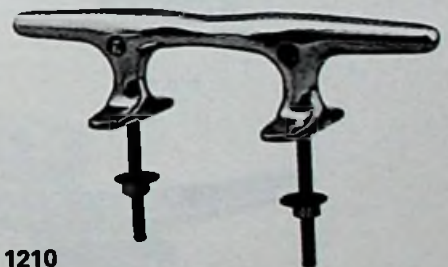

Fig. 1210

---

## SHIP'S CLEATS – Fig. 530

Cast Aluminum – Plain Finish

Length Inches	Each	Size of Base Inches	Holes for Diam. Bolts Inches	Weight Pounds
8		4 x 2-1/4	1/2	1-1/8
10		4-1/2 x 3	1/2	1-3/4
12		6-1/2 x 2-7/8	5/8	3-1/2
15		7 x 3-1/4	3/4	4-7/8



Fig. 530

### BOAT CLEATS—Fig. 544

Cast Bronze — Polished or Chromium Plated



Fig. 544



Length Inches	Polished Bronze Each	Chrome Plated Each	Size Base Inches	For Screw No.	Standard Package	Weight Pounds
• 3			1-1/2x5/8	8	10	1/8
• 4			1-5/8x3/4	10	10	1/4
• 5			2 x7/8	1/4"	10	3/8
• 6			2-1/4x7/8	1/4"	5	1-5/8
8			2-5/8x1-1/8	1/4"	1	2
10			3-5/8x1-1/2	5/16"	1	

\*These sizes are solid base type.  
Balance of sizes are open base type.

### SKIN PACK — Fig. 544-SP



Fig. 544-SP

Length Overall 4" — Chromium Plated  
One Cleat Per Card,  
Six Cards Per Box,  
Weight Per Box, 2½ Pounds.

Sold To Trade In Full Box Only

### BOAT CLEATS — Fig. 545

Pressure Cast Aluminum — Plain Finish



Fig. 545



Length Inches	Each	Size Base Inches	For Screw No.	Standard Package	Weight Ounces
• 3		1-1/2x5/8	8	10	1-1/2
• 4		1-5/8x3/4	10	10	2
• 5		2 x7/8	1/4"	10	3
• 6		2-1/4x7/8	1/4"	10	4
8		2-5/8x1-1/8	1/4"	10	5
10		3-5/8x1-1/2	5/16"	5	9
12		4 x1-1/2	5/16"	5	14

\*These sizes are solid base type.  
Balance of sizes are open base type.

### HAWSE HOLE PLATE—Fig. 752

Cast Bronze



Fig. 752

Generally used in the covering board or gunwale deck for passing a dock line to a cleat under the deck.

Plain Bronze Each	Chromium Plated Each	Dimensions Overall Inches	Dimensions Inside Inches	Length Spigot Inches	Weight Pounds
		4-1/4x6-1/4	2-1/16x4	1-1/16	1-1/4

## MOORING BITTS— Figs. 608 & 1219

Fig. 608 is Cast Bronze, Chromium Plated  
 Fig. 1219 is Die Cast Zinc Alloy, Chromium Plated

No.	Fig. 608 Each	Fig. 1219 Each	Size Base Inches	Height Inches	For Bolt Size	Weight Pounds
1		N.A.	3 x3	2-1/2	10	7/8
2		N.A.	4-1/4x4-1/4	3-1/2	1/4"	1-7/8
2-1/2			5 x5	4-3/4	3/8"	3-1/2
3		N.A.	6 x6	5	3/8"	4-1/2



Fig. 608 Bronze  
 Fig. 1219 Die Cast



## COMBINATION BITT AND ROPE DECK PIPES—

Figs. 431 & 1237

Same as Above. Hollow Body is Drilled to Allow Passage of Line Below Deck.

No.	Fig. 431 Each	Fig. 1237 Each	For Diam. Rope Inches	Weight Pounds
2		N.A.	3/4	1-3/4
2-1/2			1	3-1/4
3		N.A.	1	4
4		N.A.	1-1/4	12



Fig. 431 — Bronze  
 Fig. 1237 — Die Cast

## ROPE AND CHAIN DECK PIPE—Fig. 750

For Lightweight Anchors Using Chain —  
 Cast Bronze — Chromium Plated

When lightweight anchors are used a short length of chain is generally shackled to the rope line.

This deck pipe will accommodate 3/4 inch line on a thimble, the shackle and 1/4 inch chain. It has a hook for hanging the chain, the weight of which holds the cover down.

Each	Dimensions of Flange Inches	Dimensions Inside Inches	Height Inches	Weight Pounds
	5-1/4x4	3-3/4x2-1/2	1-3/8	2

Spare Cover With Hook and Safety Cord, Fig. 750-99 A.



## ROPE DECK PIPE—Fig. 757

Die Cast Zinc Alloy — Chromium Plated  
 With Hinged Cover

Each	For Diam. Rope Inches	Inside Diameter Inches	Diameter Flange Inches	Weight Pounds
	1	1-3/4	3-3/8	1/2



Fig. 757

## ROPE DECK PIPES—Fig. 741

Chromium Plated

Size No. 0 is Pressure Cast Silicon Bronze

Size No. 1 is Cast Bronze

No.	Each	For Diam. Rope Inches	Inside Diam. Inches	Diam. Flange Inches	For Screw No.	Weight Pounds
0		5/8	1-1/4	3	8	3/4
1		3/4 & 1	1-5/8	4-1/4	8	1-5/8



Fig. 741

Spare caps with Chain, Fig. 741-0-99A; Fig. 741-1-99A.

## "CHROMALEX® MARK I" DECK FITTINGS

DIE CAST ZINC ALLOY BODIES – POLISHED CHROMIUM PLATED  
BLACK BASES OF TOUGH HIGH IMPACT PLASTIC



Fig. 1305

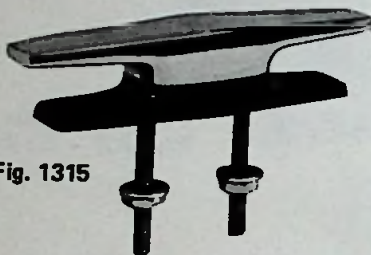

Fig. 1315



Fig. 1305-SP



Fig. 1306

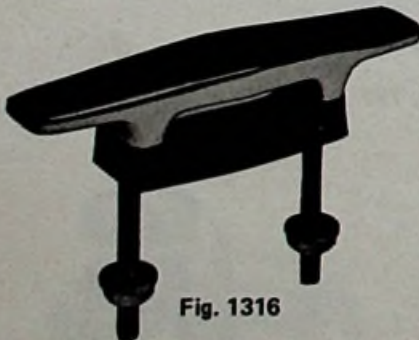

Fig. 1316



Fig. 1306-SP

### CLOSED BASE CLEATS—Figs. 1305 & 1315

Fig. 1305 For Screws or Bolts

Fig. 1315 With Studs, Nuts and Washers

No.	Fig. 1305 Each	Fig. 1315 Each	Length Overall Inches	Base Inches	For Diam. Rope Inches	Weight Ounces
1			4-1/2	3-3/4x1-1/16	3/8	5-1/2
2			6	5 x1-3/8	1/2	11

O.E.M. Package, Fig. 1315 No. 2, 40 pieces. Balance, 50 Pieces.

Fig. 1305 No. 1 for No. 10 Screws.

Fig. 1305 No. 2 for 1/4" Screws.

Fig. 1315 No. 1 Stud is 12-24" x 1-1/2" below base.

Fig. 1315 No. 2 Stud is 1/4" x 1-1/2" below base.

### SKIN PACK — Fig. 1305-SP

No.	Per Pair	Length Inches	Units Per Card	Card Per Box	Weight Per Box Pounds
No. 1		4-1/2	1 Pr.	6 Pr.	4
No. 2		6	1 Ea.	6 Ea.	4

Sold To Trade In Full Box Only.

### OPEN BASE CLEATS—Figs. 1306 & 1316

Fig. 1306 For Screws or Bolts

Fig. 1316 With Studs, Nuts and Washers

No.	Fig. 1306 Each	Fig. 1316 Each	Length Overall Inches	Base Inches	For Diam. Rope Inches	Weight Ounces
1			4-1/2	2-1/2x1-1/16	3/8	5
2			6	3-1/4x1-3/8	1/2	10-1/2

O.E.M. Package, Fig. 1316 No. 2, 40 pieces. Balance, 50 Pieces.

Fig. 1306 No. 1 for No. 10 Screws

Fig. 1306 No. 2 for 1/4" Screws.

Fig. 1316 No.1 Stud is 12-24" x 1-1/2" below base.

Fig. 1316 No. 2 Stud is 1/4" x 1-1/2" below base.

### SKIN PACK — Fig. 1306-SP

No.	Per Pair	Length Inches	Units Per Card	Cards Per Box	Weight Per Box Pounds
No. 1		4-1/2	1 Pr.	6 Pr.	4
No. 2		6	1 Ea.	6 Ea.	4

Sold To Trade In Full Box Only.

**"CHROMALEX® MARK II" DECK FITTINGS**  
**DIE CAST ZINC ALLOY BODIES – CHROMIUM PLATED**  
**BLACK PLASTIC BASES AND TOP INSERTS FOR ACCENT**

**CLOSED BASE CLEATS – Fig. 1405**

For Screws or Bolts.

No.	Length Overall Inches	Base Inches	For Rope Inches	For Screw No.	Weight Ounces
1	4-1/2	3-3/4x1-1/16	3/8	10	5-1/2
2	6	5 x1-3/8	1/2	1/4"	11



Fig. 1405

O.E.M. Package, 50 Pieces.

**CLOSED BASE CLEATS – Fig. 1415**

With Studs, Nuts and Washers.

No.	Length Overall Inches	Base Inches	For Rope Inches	Stud Size	Weight Ounces
1	4-1/2	3-3/4x1-1/16	3/8	12-24x1-1/2	5-1/2
2	6	5 x1-3/8	1/2	1/4-20x1-1/2	11

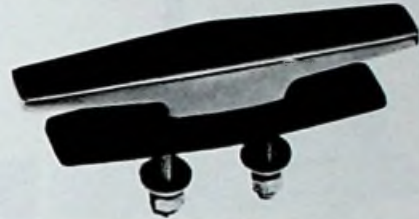

Fig. 1415

O.E.M. Package, Size No. 1 - 50 Pieces, Size No. 2 - 40 Pieces.

**OPEN BASE CLEATS – Fig. 1406**

For Screws or Bolts.

No.	Length Overall Inches	Base Inches	For Rope Inches	For Screw No.	Weight Ounces
1	4-1/2	2-1/2x1-1/16	3/8	10	5
2	6	3-1/4x1-3/8	1/2	1/4"	10
3	8	3-7/8x1-1/2	3/4	1/4"	12

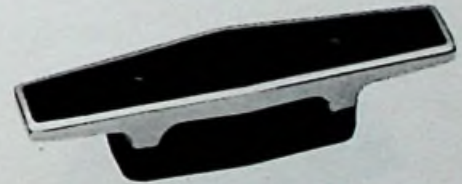
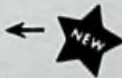

Fig. 1406

O.E.M. Package, 50 Pieces

**OPEN BASE CLEATS – Fig. 1416**

With Studs, Nuts and Washers.

No.	Length Overall Inches	Base Inches	For Rope Inches	Stud Size	Weight Ounces
1	4-1/2	2-1/2x1-1/16	3/8	12-24x1-1/2	5
2	6	3-1/4x1-3/8	1/2	1/4-20x1-1/2	10-1/2
3	8	3-7/8x1-1/2	3/4	1/4-20x1-1/2	12

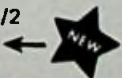

Fig. 1416

O.E.M. Package, Size No. 1 - 50 Pieces, Size No. 2 - 40 Pieces.  
 Size No. 3 - 30 Pieces



See Section "M" For Our New "Chromalex®" III Teak Deck Fittings.  
 Also, Section "L" For "Chromalex®" III Deck Fittings Available in Skin Pack.

## "CHROMALEX® MARK I" DECK FITTINGS

DIE CAST ZINC ALLOY BODIES -- POLISHED CHROMIUM PLATED  
BLACK BASES OF TOUGH HIGH IMPACT PLASTIC



Fig. 1307



Fig. 1317



Fig. 1307 SP



Fig. 1308



Fig. 1318



Fig. 1308 SP

### SKENE TYPE CHOCKS--Figs. 1307 & 1317

Fig. 1307 For Screws or Bolts

Fig. 1317 With Studs, Nuts and Washers

No.	Fig. 1307 Per Pair	Fig. 1317 Per Pair	Length Overall Inches	Width Base Inches	For Diam. Rope Inches	Weight Per Pair Ounces
1			3-1/2	7/8	3/8	5
2			5	1-1/4	1/2	12

O.E.M. Package, Fig. 1307 No. 1, 50 pairs. Balance, 25 pairs.

Fig. 1307 N. 1 for No. 10 Screws.

Fig. 1307 No. 2 for 1/4" Screws.

Fig. 1317 No. 1 Stud is 12-24"x 1-3/4" below base.

Fig. 1317 No. 2 Stud is 1/4"x 1-3/4" below base.

### SKIN PACK -- Fig. 1307-SP

No.	Per Pair	Length Overall Inches	Units Per Card	Cards Per Box	Weight Per Box Pounds
1		3-1/2	1 Pr.	12 Pr.	3-1/2
2		5	1 Pr.	6 Pr.	4

Sold To Trade In Full Box Only.

### STRAIGHT TYPE CHOCKS--Figs. 1308 & 1318

Fig. 1308 For Screws or Bolts

Fig. 1318 With Studs, Nuts and Washers

No.	Fig. 1308 Per Pair	Fig. 1318 Per Pair	Length Overall Inches	Width Base Inches	For Diam. Rope Inches	Weight Per Pair Ounces
1			3-1/2	7/8	3/8	5
2			5	1-1/4	1/2	12

O.E.M. Package, Fig. 1308 No. 1, 50 Pairs.

Balance, 25 Pairs.

Fig. 1308 No. 1 for No. 10 Screws.

Fig. 1308 No. 2 for 1/4" Screws.

Fig. 1318 No. 1 Stud is 12-24"x 1-3/4" below base.

Fig. 1318 No. 2 Stud is 1/4"x 1-3/4" below base.

### SKIN PACK -- Fig. 1308-SP

No.	Per Pair	Length Overall Inches	Units Per Card	Cards Per Box	Weight Per Box Pounds
1		3-1/2	1 Pr.	12 Pr.	3-1/2
2		5	1 Pr.	6 Pr.	4

Sold To Trade In Full Box Only

## "CHROMALEX® MARK II" DECK FITTINGS

DIE CAST ZINC ALLOY BODIES – CHROMIUM PLATED  
BLACK PLASTIC BASES AND TOP INSERTS FOR ACCENT

### SKENE TYPE CHOCKS – Fig. 1407

For Screws or Bolts.

No.	Length Overall Inches	Width Base Inches	For Rope Inches	For Screw No.	Weight Per Pair Ounces
1	3-1/2	7/8	3/8	10	5
2	5	1-1/4	1/2	1/4"	12



Fig. 1407

O.E.M. Package, 50 Pair.

### SKENE TYPE CHOCKS – Fig. 1417

With Studs, Nuts and Washers.

No.	Length Overall Inches	Width Base Inches	For Rope Inches	Stud Size	Weight Per Pair Ounces
1	3-1/2	7/8	3/8	12-24x1-3/4	5
2	5	1-1/4	1/2	1/4-20x1-3/4	12



Fig. 1417

O.E.M. Package, Size No. 1 - 50 Pair, Size No. 2 - 25 Pair.

### STRAIGHT TYPE CHOCKS – Fig. 1408

For Screws or Bolts.

No.	Length Overall Inches	Width Base Inches	For Rope Inches	For Screw No.	Weight Per Pair Ounces
1	3-1/2	7/8	3/8	10	5
2	5	1-1/4	1/2	1/4"	12



Fig. 1408

O.E. M. Package, 50 Pair.

### STRAIGHT TYPE CHOCKS – Fig. 1418

With Studs, Nuts and Washers.

No.	Length Overall Inches	Width Base Inches	For Rope Inches	Stud Size	Weight Per Pair Ounces
1	3-1/2	7/8	3/8	12-24x1-3/4	5
2	5	1-1/4	1/2	1/4-20x1-3/4	12



Fig. 1418

O.E.M. Package, Size No. 1 - 50 Pair, Size No. 2 - 25 Pair.



Fig. 1223

**SKENE BOW CHOCKS—Fig. 1223**

Die Cast Zinc Alloy – Chromium Plated

Per Pair	Length Overall Inches	Width Inches	For Diam. Rope Inches	For Screw No.	Weight Per Pair Ounces
	3-1/2	7/8	1/2	8	4

Standard Package, 10 Pairs.



**SKIN PACK – Fig. 1223-SP**

One Pair Per Card.  
Twelve Cards Per Box.  
Weight Per Box, 4½ Pounds.

Sold To Trade In Full Box Only.



**MODERN DESIGN BOW CHOCKS WITH STUDS—Fig. 1257**

Die Cast Zinc Alloy – Chromium Plated

Studs are 12/24 x 1-5/8" long – with nuts and washers

Per Pair	Length Overall Inches	Width Inches	For Diam. Rope Inches	For Screw No.	Weight Per Pair Ounces
	4	15/16	1/2	8	9

Standard Package, 10 Pairs.  
O.E.M. Package, 40 Pairs.



Fig. 1257

**BOW CHOCKS—Fig. 546**

Cast Bronze – Chromium Plated

Lgth. Inches	Per Pair	Width Inches	For Diam. Rope Inches	For Screw No.	Standard Package	Wt. Per Pair Lbs.
3		5/8	3/8	8	5 Pr.	1/4
4		3/4	5/8	10	5 Pr.	1/2
5		7/8	7/8	10	5 Pr.	1
6	1		1	14	1 Pr.	1-1/2
8		1-1/4	1-1/8	14	1 Pr.	3



**SKIN PACK – Fig. 546-SP**

Length Inches 4 – Chromium Plated

One Pair Per Card.  
Six Cards Per Box.  
Weight Per Box, 4 Pounds.

Sold To Trade In Full Box Only.

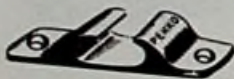

Fig. 546

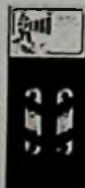

Fig. 546-SP



### SKENE BOW CHOCKS—Fig. 160

Cast Bronze — Chromium Plated

Size No.	Per Pair	Length Inches	Width Inches	For Diam. Rope Inches	Standard Package	Weight Per Pair Pounds
1		4-1/2	3/4	5/8	5 Pr.	3/4
2		5-1/8	1-1/8	3/4	5 Pr.	1-1/2
3		7-1/4	1-3/8	7/8	1 Pr.	4



Fig. 160

### SKENE STERN CHOCKS—Fig. 161

Cast Bronze — Chromium Plated

Size No.	Each	Length Inches	Width Inches	For Diam. Rope Inches	Standard Package	Weight Each Pounds
11		4	7/8	5/8	5	1/2
12		5-3/4	1-1/4	3/4	5	1
13		7	1-5/8	7/8	1	2



Fig. 161

### STRAIGHT STERN CHOCKS—Fig. 119

Cast Bronze — Chromium Plated

Length Inches	Each	Width Inches	For Diam. Rope Inches	For Screw No.	Standard Package	Wt. Each Lbs.
4		7/8	3/4	8	5	1/4
5		1	7/8	10	5	1/2
6		1-1/8	1	12	1	3/4
8		1-5/8	1-1/8	14	1	1-1/2



Fig. 119

### SKIN PACK — Fig. 119-SP

Length Inches 4 — Chromium Plated

One Per Card.

Six Cards Per Box.

Weight Per Box, 2½ Pounds.

Sold To Trade In Full Box Only.



Fig. 119-SP

### ANCHOR CHOCKS—Fig. 933

Cast Bronze

Consists of four parts illustrated. Head of shank is held fast by slotted casting and thumb screw.

Figure

No. 1		No. 2	
Plain Bronze	Plain Chromium Plated	Plain Bronze	Plain Chromium Plated

- 933 — Complete, per set
- 933-99A — Shank support only, ea.
- 933-99B — Fluke supports only, pair
- 933-99C — Crown support only, ea.

Be Sure To Specify Size and Finish.

Weight per set, 2 pounds.

No. 2-size for anchors 30 lbs. and larger.

Standard package, No. 1 - 5 sets, No. 2 - 1 set.

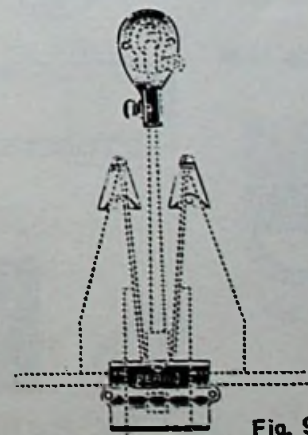

Fig. 933

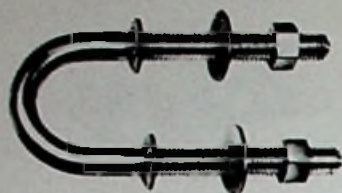

Fig. 237

**BOW EYES—Fig. 237**  
18-8 Stainless Steel — Polished

No.	Each	Length Shank Inches	Diameter Metal Inches	Length Thread Inches	Inside Eye Inches	Weight Ounces
1		3	5/16	3	1	4
2		6	5/16	4-5/8	1	5-1/2
3		3	3/8	3	1-1/8	5
4		3	1/2	3-3/8	1-1/2	12

Standard Package, Nos.1 thru 3, 10 Pieces. No. 4, 5 Pieces.



Fig. 237-SP

**SKIN PACK — Fig. 237-SP**

Length Shank 3 Inches  
One Per Card.  
Six Cards Per Box.  
Weight Per Box, 2 Pounds.

Sold to Trade In Full Box Only.

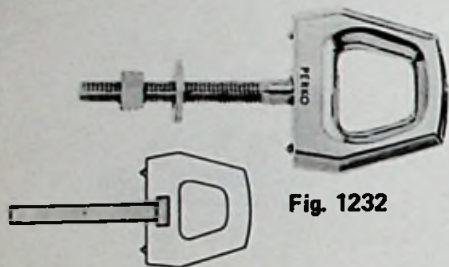

Fig. 1232

**BOW EYES—Fig. 1232**

Die Cast Zinc Alloy — Chromium Plated — Forged Steel Shank, Nut and Washer.

Eye is die cast around the square head of shank.

Each	Length Shank Inches	Length Thread Inches	Diameter Shank Inches	Eye Inside Inches	Standard Package	Weight Ounces
	3	2-1/2	3/8	1	10	10

O.E.M. Package, 50.

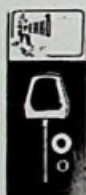

Fig. 1232-SP

**SKIN PACK — Fig. 1232-SP**

One Per Card.  
Six Cards Per Box.  
Weight Per Box, 4 Pounds.

Sold To Trade In Full Box Only

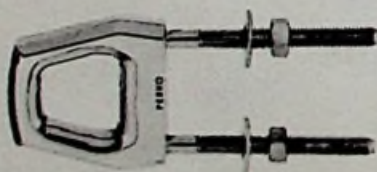

Fig. 1235

**BOW EYES—Fig. 1235**

Die Cast Zinc Alloy — Chromium Plated — Forged Steel Shanks, Nut and Washer — Shanks Are One Continuous "U" Bolt Cast Inside Eye.

Each	Length Shank Inches	Length Thread Inches	Diameter Shank Inches	Inside Eye Inches	Standard Package	Weight Ounces
	3	2-3/4	5/16	1	10	11

O.E.M. Package, 50.

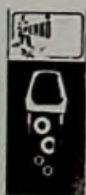
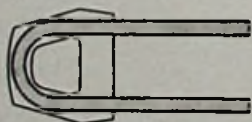

Fig. 1235-SP

**SKIN PACK — Fig. 1235-SP**

One Per Card.  
Six Cards Per Box.  
Weight Per Box, 4 1/4 Pounds.

Sold To Trade In Full Box Only.

**NOTE: THE ABOVE BOW EYES ARE NOT DESIGNED TO BEAR THE WEIGHT OF THE VESSEL AND THEREFORE SHOULD NOT BE USED FOR LIFTING.**

**TRANSOM EYES—Fig. 236**  
**18-8 Stainless Steel — Polished**

For use as towing or lashing eye, has heavy gauge stainless steel finishing plate, stainless steel nuts and washers.

No.	Each	Diameter Metal Inches	Length Shank Inches	Inside Eye Inches	Dimensions Plate Inches	Weight Ounces
1		5/16	3	1	3 x 1-3/4	6
3		3/8	3	1-1/8	3 x 1-3/4	10
4		1/2	3-1/2	1-1/2	4 x 1-3/4	14-1/2

Standard Package, No. 1 — 10 Pieces. Balance 5 Pieces.

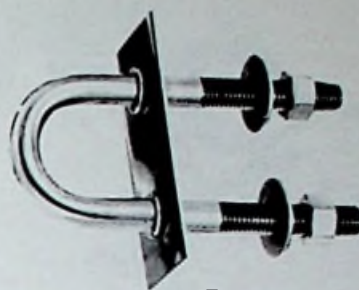

Fig. 236

★  
**WATER SKI TOWING HOOK—Fig. 863**

For Mounting Through Transom — Die Cast Zinc Alloy Hook — Steel Bolt — All Chromium Plated.

Designed for both strength and looks. Polished chromium plated hook provides a good looking fitting and the steel core provides the necessary strength for enjoyable skiing.

Each	Length Overall Inches	Diameter Bolt Inches	Length Bolt Inches	Length Thread Inches	Standard Package	Weight Ounces
	6	5/16	3-1/4	2-1/2	5	10

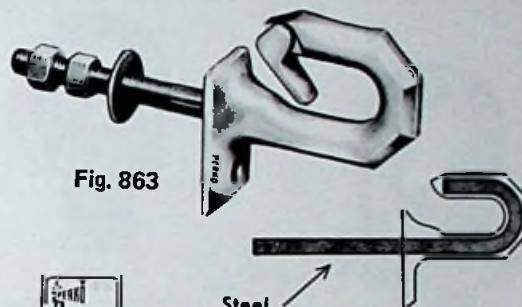

Fig. 863

Fig. 863-SP

★  
**SKIN PACK — Fig. 863-SP**

One Per Card.  
 Six Cards Per Box.  
 Weight Per Box, 3¾ Pounds.

Sold To Trade In Full Box Only.

★  
**PAD OR LASHING EYES—Fig. 423**

Cast Manganese Bronze — Chromium Plated

No.	Each	Size Plate Inches	Size Eye Inches	Size Bolt Inches	Weight Ounces
1		4x2-1/2	1	1/4	8
2		5x3-1/8	1-1/2x1	5/16	14-1/2

Standard Package, 5 Pieces.



Fig. 423

★  
**RINGS — Fig. 417**

Polished Brass

No.	Inside Diam. Inches	Thick-ness Inches	Each	No.	Inside Diam. Inches	Thick-ness Inches	Each
1	1/2	1/8	Standard Package 10	4	1-1/4	3/16	Standard Package 5
2	3/4	1/8		5	1-1/2	7/32	
3	1	3/16		6	1-3/4	1/4	
				7	2	1/4	

Standard Package 10

Standard Package 5



Fig. 417

★  
**RING ON PLATE—Fig. 607**

Galvanized Drop Forged Steel

No.	Each	Size Ring Inches	Size Plate Inches	Standard Package	Weight Per 100 Pounds
1		5/16x1-1/2	2-1/8x2-1/8x1/4	5	33
2		3/8 x2	2-1/8x2-1/8x1/4	5	50



Fig. 607

★  
**RINGS WITH STRAPS—Fig. 1020**

Cast Bronze

Plain Bronze Each	Chromium Plated Each	Size Strap Inches	For Screw No.	Standard Package	Weight Ounces
		4-1/8x5/8	8	5	4-1/2



Fig. 1020



Fig. 434

**LIFTING EYE AND CLEAT—Fig. 434**

Cast Manganese Bronze – Chromium Plated  
For 5/8 Inch Rod

Each	I.D. Eye Inches	Length Cleat Inches	Dimensions Base Inches	Weight Ounces
	1-1/16	5-1/2	3x2-1/2	18



Fig. 430  
LOOSE FLANGE



Fig. 429  
INTEGRAL FLANGE

**HEAVY DUTY LIFTING EYES—Figs. 429 & 430**

Cast Manganese Bronze – Chromium Plated

A good strong eye made to do the job and designed to conform in styling with other fittings on the modern boat.

Fig.	Each	For Rod Inches	I.D. Eye Inches	O.D. Eye Inches	Weight Ounces
429		5/8	1-1/2	2-1/4	19
430		5/8	1-1/2	2-1/4	17

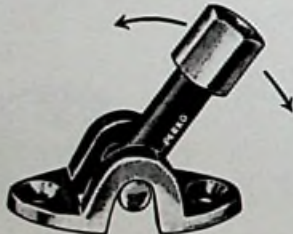

Fig. 447

**HEAVY DUTY**

**ANGULAR KEEL PLATES—Fig. 447**

Cast Manganese Bronze – Plain – For 5/8 Inch Rod

Each	Dimensions Base Inches	For Diam. Bolt Inches	Standard Package	Weight Ounces
	3-7/8x1-1/2	1/4	5	15

Spare "Tee" Fitting, Fig. 447-99A



Fig. 486

**COMBINATION KEEL PLATE & BOW EYE—Fig. 486**

STAINLESS STEEL PLATE AND BOW EYE  
MANGANESE BRONZE CONNECTING ROD—TAPPED 5/8"

Keel Plate is 5-1/2" long, 1-1/2" wide.

No.	Each	Diameter Bow Eye Inches	Length Shank Inches	Length Thread Inches	Weight Pounds
1		5/16	3	3	1-1/4
3		3/8	3	3	1-3/8
4		1/2	3-1/4	3-1/4	1-3/4



Fig. 1234

**BOW HANDLE—Fig. 1234**

Die Cast Zinc Alloy – Chromium Plated

Chromium Plated Each	Length Overall Inches	Height Above Deck Inches	For Screw No.	Standard Package	Weight Ounces
	6-1/2	2	8	10	5-1/2

## CHROMALEX® TRANSOM HANDLES – Figs. 1336 & 1346

Die Cast Zinc Alloy – Chromium Plated Tops  
Black Plastic Bases.

Fig. 1336 for 1/4" Screws

Fig. 1346 with Studs, Nuts and Washers

Fig. 1336 Each	Fig. 1346 Each	Length Overall Inches	Length Inside Inches	Width Overall Inches	Stud Size	Weight Ounces
		6-1/4	3-1/2	1-1/4	1/4-20x1-1/2	10



Fig. 1336

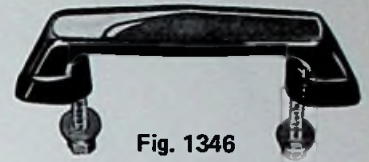

Fig. 1346



Fig. 1336-SP

### SKIN PACK – Fig. 1336-SP

One Pair Per Card.

Six Cards Per Box.

Weight Per Box, 7 Pounds.

Sold To Trade In Full Box Only.

### TRANSOM HANDLE—Fig. 1229

Die Cast Zinc Alloy – Chromium Plated

Chromium Plated Each	Length Overall Inches	Length Inside Inches	For Screw No.	Standard Package	Weight Ounces
	5-1/4	3-1/2	6	10	2-1/4



Fig. 1229

### ROUND GRIP TRANSOM HANDLE—Fig. 1231

Die Cast Zinc Alloy – Chromium Plated

Extra strong for heavy boats. The round grip has no sharp edges and is ample to accommodate a man size hand.

Each	Length Overall Inches	Length Inside Inches	Height Inside Inches	For Screw No.	Standard Package	Weight Ounces
	6	3-1/2	1-5/16	1/4"	10	7-1/4

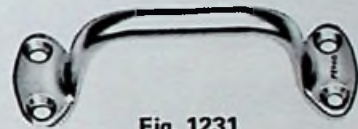

Fig. 1231



Fig. 1231-SP

### SKIN PACK – Fig. 1231-SP

One Pair Per Card.

Six Cards Per Box.

Weight Per Box, 6 3/4 Pounds.

Sold To Trade In Full Box Only.

### TRANSOM HANDLES—Figs. 775 & 1222

Pressure Cast Silicon Bronze Or Die Cast Zinc Alloy

Fig.	No.	Chrome Plated Each	Length Overall Inches	Length Inside Inches	For Screw No.	Wt. Ozs.
775	1		4-1/4	2-5/8	6	2
775	2		5-3/4	3-3/4	8	4
1222			5-3/4	3-3/4	8	3-1/2



Fig. 775 – Bronze  
Fig. 1222 – Die Cast

Standard Package, 10 Pieces Each Size.

### SKIN PACK – Fig. 775-SP

Length Overall 5 3/4 Inches.

One Pair Per Card.

Six Cards Per Box.

Weight Per Box, 4 Pounds.

Sold To Trade In Full Box Only.

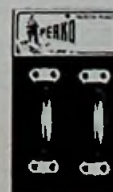

Fig. 775-SP

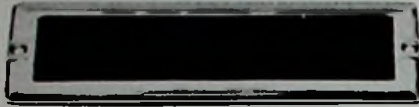

Fig. 1325

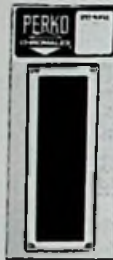

Fig. 1325-SP



Fig. 1225



Fig. 1225-SP



Fig. 1043

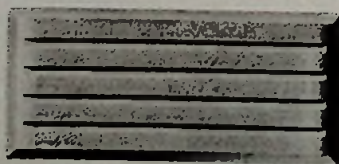

Fig. 1050-B – Black  
Fig. 1050-T – Teak  
Fig. 1050-W – White

## “CHROMALEX®” STEP PLATES – Fig. 1325

Die Cast Zinc Alloy Frames – Chromium Plated  
Molded Black Plastic Non-Skid Pads

No.	Each	Overall Dimensions Inches	For Screw No.	Standard Package	Weight Ounces
0		8-3/8x2-1/4	8	10	5
1		8-3/4x3-1/4	8	10	8



→ See Section “M” For Our New “Chromalex®” III Step Plates

## SKIN PACK – Fig. 1325-SP

No.	Per Pair	Dimensions Overall Inches	Units Per Card	Cards Per Box	Weight Per Box Pounds
0		8-3/8x2-1/4	1 Pr.	6	6
1		8-3/4x3-1/4	1 Pr.	6	9-1/2



→ See Section “L” For Our New “Chromalex®” III Skin Pack Step Plates

Sold To Trade In Full Box Only. ★

## STEP PLATES—Fig. 1225

Die Cast Zinc Alloy Frames – Chromium Plated  
Molded White Plastic Non-Skid Pads

No.	Complete Each	Dimensions Overall Inches	For Screw No.	Standard Package	Weight Ounces
0		8-3/8x2-1/4	8	10	5
1		8-3/4x3-1/4	8	10	8
2		11-1/2x5-3/4	8	10	12



## SKIN PACK – Fig. 1225-SP

No.	Per Pair	Dimensions Overall Inches	Units Per Card	Cards Per Box	Weight Per Box Pounds
0		8-3/8x2-1/4	1 Pr.	6	6
1		8-3/4x3-1/4	1 Pr.	6	9-1/2



## STEP PLATES—Fig. 1043

Cast Bronze Frames – Chromium Plated  
Molded White Plastic Non-Skid Pads

No.	Complete Each	Overall Dimensions Inches	For Screw No.	Standard Package	Weight Pounds
0		8 x2-1/4	4	6	1/2
1		8-3/4x3-1/4	6	6	3/4
2		11-1/2x5-3/4	8	6	1-3/4



## STEP PADS ONLY

Molded Plastic, Non-Skid Design

Fig. 1050-B Black

Fig. 1050-T Teak

Fig. 1050-W White

Without Frames – For Figs. 1043, 1225, 1325 & 1525

Fig. 1050-B No.	Fig. 1050-T No.	Fig. 1050-W No.	Overall Dimensions Inches	Standard Package	Weight Ounces
0	0	0	7-3/8x1-1/2	5	1
1	1	1	7-7/8x2-1/2	5	2
		2	10-5/8x4-3/4	5	4

**LADDER HOOKS—Fig. 717**  
For Folding Boarding Ladders  
Cast Bronze — Chromium Plated

A Inches	B Inches	C Inches	Length Curved Arm Inches	Size Plate Inches	Weight Per Set Pounds
6-1/8	4	2-1/2	7	2-1/2x3-1/4	2-1/2

Fig. 717 Complete, Per Set.  
Fig. 717-99A Spare Plates, Per Pair.  
Fig. 717-99B Spare Arms, Per Pair.

A Set Consists of Four Pieces Illustrated.

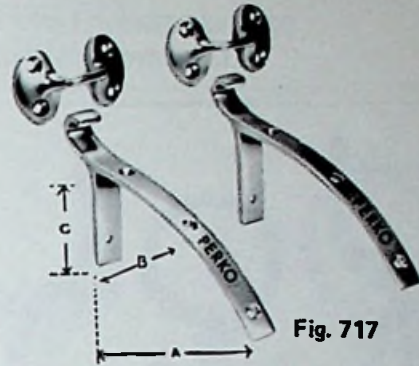

Fig. 717

**LADDER LOCKS—Fig. 669**  
For Companionway or Upper Berth — Pressure Cast Silicon  
Bronze — Chromium Plated

Height Inches	Length Socket Inches	Length Bracket Inches	Weight Per Set Ounces
1-1/4	1	1-3/4	12

Fig. 669 Complete, Per Set.  
Fig. 669-99A Spare Sockets, Per Pair.

A Set Consists of Four Pieces Illustrated.  
Standard Package, 5 Sets.



Fig. 669

**FOLDING STEP—Fig. 344**  
Cast Bronze — Stainless Steel Spring

For mounting on hull or transom, folds up out of way when not in use. Spring holds step in position.

Mounting Holes for 5/16 Inch Bolt.

Plain Bronze Each	Chromium Plated Each	Size Step Inches	Size Base Inches	Extends Folded Inches	Weight Pounds
		4x2	4-1/4x1-3/4	7/8	1-1/8

Spare Stainless Steel Springs, Fig. 344-99A.

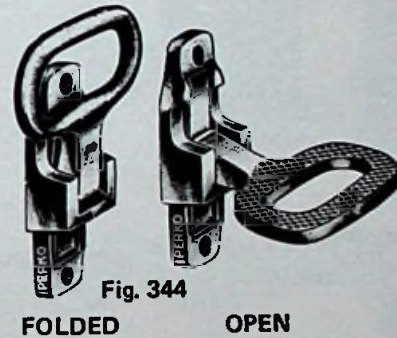

Fig. 344

FOLDED

OPEN

**BOARDING STEP—Fig. 351**  
Cast Bronze

Designed for mounting on transom, permitting easy access to or from the water or for mounting on bulkhead for climbing to the flying bridge.

All high spots are polished.

Plain Bronze Each	Chromium Plated Each	Dimensions Of Step Inches	Dimensions Mounting Bracket Inches	Weight Pounds
		6x4-1/4	6x2	1-5/8



Fig. 351

**BOARDING STEP—Fig. 501**  
Cast Bronze

Plain Bronze Each	Chromium Plated Each	Dimensions Of Step Inches	Dimensions Mounting Bracket Inches	Weight Pounds
		11x4-1/2	11x2	2-7/8



Fig. 501

**ROWLOCK HORNS AND SOCKETS**  
**DIE CAST ZINC ALLOY – NATURAL OR CHROMIUM PLATED FINISH**  
**ALL SOCKETS HAVE DELRIN BEARING – SMOOTH AND QUIET**



Fig. 1227



Fig. 1262



Fig. 1267

**HORNS ONLY**  
**Straight Shanks**

Diameter Shank Inches	Length Shank Inches	Between Horns Inches	Inside Diameter Fig. 1267 Inches	Standard Package	Weight Per Pair Ounces
1/2	1-3/4	1-3/4	2	10 Pr.	9

Fig.	Natural Finish Per Pair	Chromium Plated Per Pair
1227		
1262		
1267		

Spare Pins, Specify Fig. 1227, 99A, Standard Package, 10.

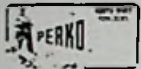

Fig. 1227-SP

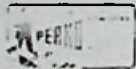

Fig. 1262-SP

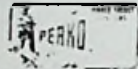

Fig. 1267-SP

**SKIN PACK – Figs. 1227-SP, 1262-SP and 1267-SP**  
 Natural and Chromium Plated Finish

One Pair Per Card.  
 Six Cards Per Box.  
 Weight Per Box, 4 Pounds.

Sold To Trade In Full Box Only.



Fig. 1185



Fig. 1186



Fig. 1187

**SOCKETS ONLY**  
**For Straight Shanks Above**

Fig.	Length Inches	Width Inches	Depth Inches	Standard Package	Weight Per Pair Ounces
1185	2-7/8	1-1/8	1-1/8	10 Pr.	5
1186	4	7/8	1-1/8	10 Pr.	9
1187	4	—	1-1/4	10 Pr.	6

Fig.	Natural Finish Per Pair	Chromium Plated Per Pair
1185		
1186		
1187		

Spare Delrin Bearings for Above Sockets  
 Specify Fig. 1155 – Standard Package 20.  
 Note, Each Socket Requires 2 Bearings.



Fig. 233

**OAD LEATHERS AND BUTTONS—Fig. 233**  
**Russet Leather**

Per Pair	Dimension Leathers Inches	Dimension Buttons Inches	Standard Package	Weight Per Pair Ounces
	7x6-1/2	1/2x13	5 Pr.	10

Note, Pair Consists Of 2 Leathers and 2 Buttons.

NOTE, Combinations of Above Sockets and Horns Are Available in Skin Pack. See Skin Pack Section L.



## BRONZE ROWLOCK HORNS AND SOCKETS CAST MANGANESE BRONZE – BURNISHED

### HORNS ONLY

Straight Shanks

Figs. – 828, 829 & 830

Fig.	Size No.	Between Horns Inches	Inside Diam. Inches	Diam. Shank Inches	Length Shank Inches	Weight Per Pair Ounces
828		2	—	1/2	2-1/8	13
829	0	—	2	1/2	2-1/8	14
829	1	—	2-1/4	1/2	2-1/8	16
830		2-1/8	—	1/2	2-1/8	13



Fig. 828



Fig. 829



Fig. 830

Standard Package, 5 Pair.

Spare Pins, Specify Fig. 830-99A, Standard Package, 10.

### SOCKETS ONLY

For Straight Shanks Above

Fig.	Length Inches	Width Inches	Depth Inches	For Screw No.	Weight Per Pair Ounces
831	2-3/8	7/8	1	10	4
832	3-5/8	—	1-3/8	10	7
833	4	3/4	1-1/4	10	8



Fig. 831



Fig. 832



Fig. 833

Standard Package, 5 Pair.

### TRANSOM PLATES—Fig. 1224

Die Cast Zinc Alloy – Chromium Plated

For outboard motor brackets, saves wear and tear on transom and helps to prevent loss of motor.

No.	Per Pair	Length Overall Inches	Inside Diameter Inches	Weight Per Pair Ounces	Standard Package
1		3-1/2	1-7/8	2-3/4	10 Pr.
2		3-1/2	2-1/16	3	10 Pr.



Fig. 1224

### SKIN PACK – Fig. 1224-SP

Size No.1 Only.

One Pair Per Card.

Twelve Cards Per Box.

Weight Per Box, 3 3/4 Pounds.

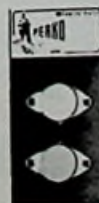

Fig. 1224-SP

Sold To Trade In Full Box Only.



Fig. 1337

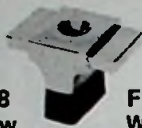

Fig. 1338  
For Screw



Fig. 1347

Fig. 1348  
With Studs

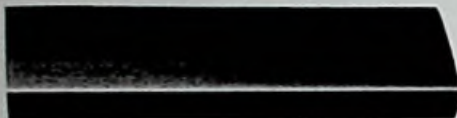
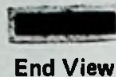

Fig. 1339



End View



Fig. 413 End Posts

Fig. 413-A Center Posts

Fig. 1297 End Posts  
Fig. 1298 Center Posts



Fig. 380 End Posts  
Fig. 380-A Center Posts

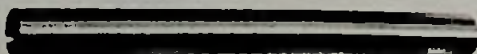

Fig. 497 – Aluminum  
Fig. 498 – Stainless Steel  
Fig. 916 – Stainless Steel

### “CHROMALEX®” GRAB RAILS

Die Cast Zinc Alloy – Chromium Plated  
Black Plastic Base  
Anodized Aluminum Tubing

Figs. 1337 and 1338 are for 1/4" Screws or Bolts.  
Figs. 1347 and 1348 have 1/4" Studs, 1-3/4" Below Base.  
Fig. 1339 Tubing is 1-1/8" wide, 3/8" thick.

Fig.	Each	Height Inches	Base Inches	Weight Ounces
1337		1-3/8	1-3/8 x 1-1/16	3
1338		1-3/8	1-3/16 x 1/2	3
1347		1-3/8	1-3/8 x 1-1/16	4
1348		1-3/8	1-3/16 x 1/2	3-1/2

Fig. 1339 TUBING  
6 Foot Lengths –

MINIMUM QUANTITY AND STANDARD PACKAGE, 5 LENGTHS

### GRAB RAIL POSTS—Figs. 413 & 413-A

Cast Bronze – Chromium Plated – For 1 Inch O.D. 20 Gauge Tubing

Fig.	Each	Height Overall Inches	Dimensions Base Inches	For Screw No.	Standard Package	Weight Ounces
413		2-1/4	3 x 2	8	1	10
413-A		2-1/4	2-3/4 x 1-1/2	8	1	7-1/4

### GRAB RAIL POSTS—Figs. 1297 & 1298

Die Cast Zinc Alloy – Chromium Plated  
For 3/4 inch rod or tubing

Each	Height Overall Inches	Diameter Base Inches	Weight Ounces
	1-3/4	1-5/8	2-3/4

Standard Package, Fig. 1297 - 4 Pieces; Fig. 1298 - 2 Pieces.

### GRAB RAIL POSTS—Figs. 380 & 380-A

Cast Bronze – Hollow – Chromium Plated

Each	Diameter Hole Inches	Height Overall Inches	Diameter Base Inches	Standard Package	Weight Ounces
	1	3-3/8	2-1/2	1	10

### TUBING

#### ANODIZED ALUMINUM – POLISHED—Fig. 497

Each	Outside Diameter Inches	Length Feet	Weight Ounces
	3/4	6	10

MINIMUM QUANTITY AND STANDARD PACKAGE, 3 LENGTHS

#### STAINLESS STEEL TUBING—Fig. 498

Each	Outside Diameter Inches	Length Feet	B & S Gauge	Weight Pounds
	1	6	20	2

MINIMUM QUANTITY AND STANDARD PACKAGE, 3 LENGTHS

#### STAINLESS STEEL TUBING – Fig. 916

18-8 Non Magnetic – Polished – 7/8" O.D. – .049 Wall

Each	Length Feet	Weight Pounds
	6	2-1/4

MINIMUM QUANTITY AND STANDARD PACKAGE, 3 LENGTHS

**"PERKO" RAIL FITTINGS**  
**Cast Bronze – Polished Chromium Plated**  
**With Stainless Steel Allen Set Screws – Drilled and Countersunk 1/4"**

**ROUND ANGLE BASE—Fig. 992**

Each	For Tubing Inches	Diameter Base Inches	Height Inches	Weight Ounces
	7/8	2-5/8	1-3/4	8

Included angle – 60°



**ROUND STRAIGHT BASE—Fig. 973**

Each	For Tubing Inches	Diameter Base Inches	Height Inches	Weight Ounces
	7/8	2-5/8	1-5/8	7



**RECTANGULAR ANGLE BASE—Fig. 981**

Each	For Tubing Inches	Dimensions Base Inches	Height Inches	Weight Ounces
	7/8	2-7/8x1-3/4	1-3/4	8

Included angle – 60°



**RECTANGULAR STRAIGHT BASE—Fig. 977**

Each	For Tubing Inches	Dimensions Base Inches	Height Inches	Weight Ounces
	7/8	2-3/4x1-3/4	1-5/8	6-1/2



**ANGLE TEE—Fig. 990**

Right or Left Hand

Each	For Tubing Inches	Length Inches	Height Inches	Weight Ounces
	7/8	2	2-3/16	6

Included angle – 60°  
 Please specify hand.



**STRAIGHT TEE—Fig. 989**

Each	For Tubing Inches	Length Inches	Height Inches	Weight Ounces
	7/8	2	2	6



**BOW FORM—Fig. 993**

With 3/4" Flag Pole Socket

Each	For Tubing Inches	Width Overall Inches	Angle Degree	Weight Ounces
	7/8	4-1/4	110	12-1/2



**GRAB RAILS – Fig. 936**

18-8 Stainless Steel 7/8" Tubing - Chromium Plated Brass  
 Ends – Chromium Plated Cast Bronze Bases – Stainless  
 Steel Screws.

No.	Each	Length Overall Inches	Height Under Tubing Inches	Weight Pounds
1		12	1-1/4	1
2		18	1-1/4	1-3/8



Fig. 992



Fig. 973

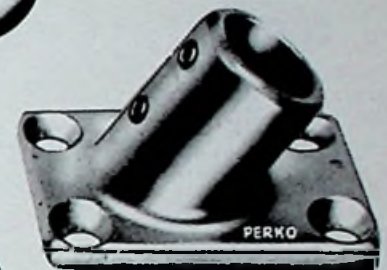

Fig. 981

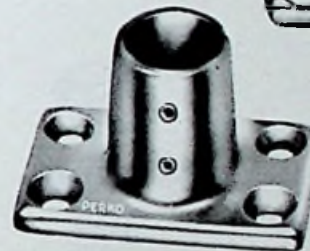

Fig. 977



Fig. 990



Fig. 989



Fig. 993

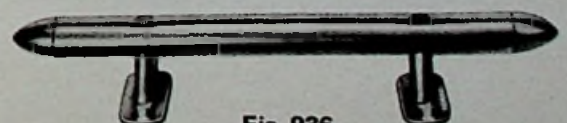

Fig. 936



Fig. 180



Fig. 185



Bow  
Fig. 218



Stern  
Fig. 219



Bow  
Fig. 220



Stern  
Fig. 221



Fig. 343 Stern



Fig. 148



### FITTINGS FOR WOOD GUARD RAILS

Cast Bronze – Chromium Plated – Stainless Steel Pins

HINGE—Fig. 180  
LATCH—Fig. 185

No.	Fig. 180 Each	Fig. 185 Each	Size Rail Inches	Length Overall Inches	Weight Pounds
1			2-3/8x1-3/8	5	3/4
2			2-7/8x1-1/4	5-1/2	1



### FLUSH TYPE FLAG POLE SOCKETS—Figs. 218 & 219

Cast Bronze – Chromium Plated

No.	Inside Diam. Inches	Fig. 218 Each	Fig. 219 Each	Diam. Flange Inches	Depth Socket Inches	Weight Ounces
1	3/4			2	1-1/2	4-1/2
2	1			2-3/8	1-3/4	5
3	1-1/4			2-5/8	2	9
4	1-1/2			3-1/8	2-3/8	15



### UPRIGHT TYPE FLAG POLE SOCKETS—Figs. 220 & 221

Cast Bronze – Chromium Plated

No.	Inside Diam. Inches	Fig. 220 Each	Fig. 221 Each	Diam. Base Inches	Height Inches	Weight Ounces
1	3/4			2-1/8	1-3/4	5-1/4
2	1			2-1/2	2	6-3/4
3	1-1/4			2-3/4	2-1/8	10-3/4



### UPRIGHT TYPE FLAG POLE SOCKETS—Fig. 343

Zamak Die Castings – Chromium Plated – Drilled For No. 6 Screw

Each	Inside Diam. Inches	Size Base Inches	Height Overall Inches	Standard Package	Weight Ounces
	3/4	3x2-1/8	2	5	4-1/2



### TABLE BRACKETS—Fig. 148

18-8 Stainless Steel – Satin Finish

For removable tables in cabin or cockpit.

A pair of angle brackets attached to table and several pairs of wall plates mounted in cabin and cockpit allows placing of table as desired.

Angle bracket cannot jump out of wall plate when table leg is firmly placed on deck.

Dimensions Angle Bracket Inches	Dimensions Wall Plate Inches	Weight Bracket Ounces	Weight Wall Plate Ounces
2-3/4x1-11/16	3-3/8x2	3	3

Fig. 148 Complete Per Set  
Fig. 148, 99-A Spare Angle Brackets Per Pair  
Fig. 148, 99-B Spare Wall Plates Per Pair

Standard Package, 5 Sets.

A set consists of 2 brackets and 2 plates.

**FENDER LOCK—Fig. 1299**

Die Cast Zinc Alloy — Chromium Plated

Attach and detach fenders instantly, eye is permanently fastened to fender line, it quickly engages the deck flange and stays there until its job is done.

Each	Diameter Flange Inches	I.D. Eye Inches	Standard Package	Weight Ounces
	1-1/2	3/8	10	1

Spare Eyes, Specify Fig. 1299-99A.



Fig. 1299

**SKIN PACK — Fig. 1299-SP**

One Pair Per Card.

Twelve Cards Per Box.

Weight Per Box, 2 3/4 Pounds.

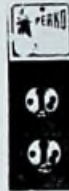

Fig. 1299-SP

Sold To Trade In Full Box Only

**FENDER HOOKS—Fig. 1246**

Die Cast Zinc Alloy — Chromium Plated

Each	For Rope Diameter Inches	Size Plate Inches	For Screw No.	Weight Ounces
	3/8	1-3/4x1-1/4	6	1-1/4

Standard Package, 10 Pieces.



Fig. 1246

**SKIN PACK — Fig. 1246-SP**

One Pair Per Card.

Twelve Cards Per Box.

Weight Per Box, 2 3/4 Pounds.



Fig. 1246-SP

Sold To Trade In Full Box Only.

**SNAP TYPE FENDER HOOK — Fig. 1309**

Die Cast Zinc Alloy — Chromium Plated

No more lost fenders, the snap does the job.

Each	For Rope Diameter Inches	Size Plate Inches	For Screw No.	Weight Ounces
	1/4	1-9/16x1-3/8	6	1-1/2

Standard Package, 10 Pieces.



Fig. 1309

**DOCK LINE SPRINGS—Fig. 759**

Steel — Zinc Plated

A very strong compression spring for dock and mooring lines. It cushions the strain and contributes greatly to the life of the line. Size No. 1 will accommodate 1/2 inch diameter rope, No. 2 for 3/4 inch rope.

No.	Each	Length Overall Inches	Diameter Spring Inches	Diameter Metal Inches	Compression Inches	Weight Pounds
1		10	1-1/2	3/16	4-1/2	7/8
2		18	2	1/4	8	2-3/4

Standard Package — No. 1-5 Pcs., No. 2-1 Pc.



Fig. 759



Fig. 492

**BOAT HOOK HOLDERS—Fig. 492**  
**18-8 Stainless Steel — Polished**

Will accommodate poles up to 1-1/2 inch in diameter, and hold them firmly in place.

Per Pair	Length Inches	Width Inches	For Screw No.	Standard Package	Weight Ounces
	3-1/2	1	6	10 pr.	1-1/2



**SKIN PACK — Fig. 492-SP**

One Pair Per Card.  
 Twelve Cards Per Box.  
 Weight Per Box, 3 Pounds.

Sold To Trade In Full Box Only.



**“HOLDALL” SPRING CLAMPS—Fig. 502**

**18-8 Stainless Steel — Polished**

Excellent for stowing fishing rods, boat hooks, oars, swab, broom, flashlight, flagstaff, pump, etc.

No.	Per Pair	Adjustability Inches	Length From Wall Inches	Width of Metal Inches	For Screw No.	Weight Per Pair Ounces
1		5/8 to 1-1/4	1-1/2	1/2	6	2
2		1 to 1-3/4	2-1/4	5/8	6	2-1/2

Standard Package, 10 Pair Per Size.



**SKIN PACK — Fig. 502-SP**

Size No.1 Only.  
 One Pair Per Card.  
 Twelve Cards Per Box.  
 Weight Per Box, 3 Pounds.

Sold To Trade In Full Box Only.



**HAND WINDSHIELD WIPERS—Fig. 533**

For Straight or Curved Windshields — Stainless Steel Extensible Arm and Blade Holder — Other Parts Chromium Plated — Rustproof — Leakproof — With 12 Inch Blade

The arm is extensible from 6 3/4 to 10 1/2 inches, spring tension is adjustable for best wiping pressure.

No. 1 Each	No. 2 Each	Length Overall Inches	Diam. Shaft Inches	Length Handle Inches	Weight Ounces
		8 to 11-1/2	3/8	2-3/8	8

For thickness of wood up to 1-1/8 inches.

Spare Arm, Fig. 533-99A	.....	each
Spare Straight Blade, Fig. 533-99B	.....	each
Spare Curved Blade, Fig. 533-99C	.....	each



**SKIN PACK — Fig. 533-SP**

Size No.1 Only.  
 One Per Card.  
 Three Cards Per Box.  
 Weight Per Box, 2 Pounds.

Sold To Trade In Full Box Only.

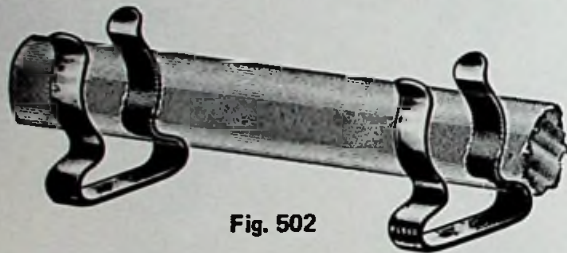

Fig. 502



Fig. 492-SP

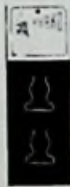

Fig. 502-SP



Fig. 533

No. 1 with Straight Blade



No. 2 with Curved Blade



Fig. 533-SP

## RING BUOY HOLDERS – Fig. 1017

Brass

Plain Brass Each	Chromium Plated Each	Width Mounting Plate Inches	Hgt. Overall Inches	For Screw No.	Wt. Lbs.
		3	4-1/2	8	1/2

Standard Package, 5 Pieces



Fig. 1017

## SKIN PACK – Fig. 1017-SP

One Per Card.  
Four Cards Per Box.  
Weight Per Box, 2½ Pounds.

Sold To Trade In Full Box Only.



Fig. 1017-SP

## AXE BRACKETS—Fig. 325

18-8 Stainless Steel – Polished

A set consists of one blade socket and one handle bracket as illustrated.

Fig. 325 Complete Per Set	Fig. 325-99A Blade Sockets Only Each	Fig. 325-99B Handle Brackets Only Each	For Blade Width Inches	Standard Package	Weight Per Set Ounces
			6	10 sets	4-1/2



Fig. 325

## BOAT HOOKS—Fig. 224

Ball Points – Galvanized Malleable Iron

Size No.	Each	For Diam. Pole Inches	Extreme Length Inches	Standard Package	Weight Ounces
4		1-1/4	8-1/4	5	12
5		1-1/2	9-3/8	5	18

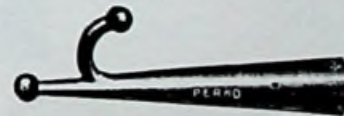

Fig. 224

NOTE – Pole end is measured by outside diameter to fit flush with surface of pole.

## DECK STRAPS—Fig. 882

Cast Bronze

No.	Plain Bronze Each	Chromium Plated Each	Length Inches	Size Eye Inches	Standard Package	Wt. Ozs.
1			3-1/2	1/2	10	2-1/2
2			4-1/8	9/16	10	2-1/2



Fig. 882

## NEW FLANGE EYE – Fig. 1236

Die Cast Zinc Alloy – Chromium Plated

Each	Size Opening Inches	Size Base Inches	Standard Package	Weight Ounces
	3/4	2-5/16x1-1/16	10	1



Fig. 1236



Fig. 612

**FAST EYE BOAT SNAPS—Fig. 612**  
Galvanized Malleable Iron Or Bronze

Size No.	Galv. Each	Plain Bronze Each	Inside Diam. Eye Inches	Extreme Length Inches	Standard Package	Weight Per 100 Pounds
0			3/8	2-1/16	10	6-1/4
1			5/8	2-7/8	10	12
2			3/4	3	10	13-1/2
3			3/4	3-7/8	10	24
4		N.A.	7/8	4-1/2	10	40
5		N.A.	1-1/8	5	10	50
6		N.A.	1-1/8	5-1/4	10	68-3/4



Fig. 613

**SWIVEL EYE BOAT SNAPS—Fig. 613**  
Galvanized Malleable Iron Or Bronze

Size No.	Galv. Each	Plain Bronze Each	Inside Diam. Eye Inches	Extreme Length Inches	Standard Package	Weight Per 100 Pounds
1			9/16	3-1/4	10	12-1/2
2			11/16	3-5/8	10	16
3			3/4	4-5/8	10	30
4		N.A.	13/16	4-7/8	10	42
5		N.A.	1-1/16	5-3/4	10	61



Fig. 659

**SWIVEL EYE SNAP — Fig. 659**  
Cast Bronze

Each	Extreme Length Inches	Inside Eye Inches	Inside Hook Inches	Standard Package	Weight Ounces
	3-1/2	3/4	7/16	25	2-1/2



Fig. 659-SP

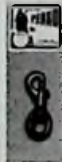

**SKIN PACK — Fig. 659-SP**

One Per Card.  
Ten Cards Per Box.  
Weight Per Box, 2 Pounds.

Sold To Trade In Full Box Only.



Fig. 606

**SAFETY MOORING HOOKS—Fig. 606**

Galvanized Drop Forged Steel — Stainless Steel Spring

No.	Each	I.D. of Eye Inches	Length Overall Inches	Throat Opening Inches	Standard Package	Weight Per 100 in Lbs.
1		3/4	4	3/4	10	25
1-1/2		1-1/8	4-3/4	3/4	10	32
2		1	5-3/8	13/16	5	100



Fig. 606-SP

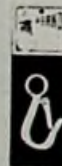

**SKIN PACK — Fig. 606-SP**

Size No.1 Only.  
One Per Card.  
Twelve Cards Per Box.

Weight Per Box, 2½ Pounds.



Fig. 614

**SAFETY SNAP—Fig. 614**

18-8 STAINLESS STEEL — Non Magnetic Interlocking Tongue

Each	Length Inches	I.D. Eye Inches	Diam. Steel Inches	Standard Package	Weight Ounces
	3	3/8	5/16	10	2-1/2



**SWIVEL EYE SNAP—Fig. 1289**

Die Cast Zinc Alloy – Chromium Plated – Stainless Steel Spring

Has an interlocking device on tongue and hook.



Fig. 1289

Each	Inside Diam. Eye Inches	Extreme Length Inches	Standard Package	Weight Per 100 Pounds
	5/8	3	25	12-1/2



**SKIN PACK – Fig. 1289-SP**

One Per Card.

Twelve Cards Per Box.

Weight Per Box, 2½ Pounds.



Fig. 1289-SP

Sold To Trade In Full Box Only.



**FAST EYE BABY SNAPS—Figs. 842 & 1041**

Cast Brass

Fig.	Each	Size of Eye Inches	Length Inches	Standard Package	Weight Ounces
842		3/8	1-7/8	50	1/2
1041		5/8x3/16	1-5/8	50	1/2



Fig. 1041



Fig. 842



**SWIVEL EYE BABY SNAPS—Fig. 1042**

Cast Brass

Each	Length Inches	Diam. of Eye Inches	Standard Package	Weight Ounces
	2-1/8	3/8	50	1/2



Fig. 1042



**“S” HOOKS—Fig. 680**  
Galvanized Wrought Steel

No.	Nominal Size Inches	Each	Length Overall Inches	Standard Package	Weight Per 100 Pounds
1	3/16		1-1/2	50	2-3/4
2	1/4		2	50	7
3	5/16		2-1/2	50	14-1/2
4	3/8		3	50	18-3/4



Fig. 680



**SHEAVES—Fig. 154**

White Plastic – Common Bushed

No.	Each	Diam. Inches	Thickness Inches	For Rope Inches	For Size Pin Inches	Standard Package
20		7/8	3/8	1/4	3/16	10
28		2-5/16	3/8	1/4	1/4	10



Fig. 154



**ASSORTED BRASS PINS – Fig. 1176**

Flat Head

No.	Each	Diam. Pin Inches	Length Under Head Inches	Diam. Head Inches	Standard Package
4		3/16	1	1/4	10
5		1/4	5/8	5/16	10
10		1/4	1-1/4	5/16	10
15		5/16	1-1/4	3/8	10
27		1/2	1-1/4	5/8	10

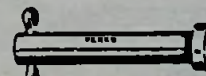

Fig. 1176



Fig. 314

**ANCHOR SHACKLES – Fig. 314**  
Galvanized Drop Forged Steel – Screw Pin Type

No.	Size Inches	Each	Standard Package	Approx. Weight Per 100 in Pounds
1	3/16		10	7
2	1/4		10	11
3	5/16		10	20
4	3/8		10	31
5	7/16		10	47
6	1/2		10	68
7	5/8		5	137
8	3/4		5	220



Fig. 466

**WIRE ROPE THIMBLES—Fig. 466**  
Galvanized Steel, Or Stainless Steel

No.	For Size Rope Inches	Galv. Each	Stainless Steel Each	Standard Package	Galv. Wt. Per 100 in Lbs.
1	1/8			20	2-5/8
2	3/16			20	2-5/8
3	1/4			20	4-3/8
4	5/16			20	5-1/2
5	3/8			20	10-5/8
6	1/2			20	15-1/2
7	5/8		N.A.	10	27-1/2
8	3/4		N.A.	10	40
9	7/8		N.A.	10	55
10	1		N.A.	10	79



Fig. 333

**WIRE ROPE CLIPS—Fig. 333**  
Malleable Iron Saddle – Steel U-Bolt And Nuts

No.	Size Wire Rope Inches	Cadmium Plated Per 100	Est. Wt. Per 100 in Lbs.	No.	Size Wire Rope Inches	Cadmium Plated Per 100	Est. Wt. Per 100 in Lbs.
1	1/8		4-1/4	5	3/8		24
2	3/16		7	6	1/2		37
3	1/4		14-1/2	7	5/8		59
4	5/16		16				

Standard Package, Sizes 1 thru 3, 25 Pcs. 4 & 5, 10 Pcs. 6 & 7, 5 Pcs.



Fig. 396

**PETITE TURNBUCKLES—Fig. 396**  
Bronze – S.A.E. Threads – Eye and Eye

No.	Each	Diam. Thread Inches	Length Extended Inches	Takeup Inches	Weight Per 100 in Lbs.
1		1/8	3	3/4	3
2		5/32	4	1-1/8	6-1/4
3		3/16	5	1-1/2	11-1/2
4		1/4	5-3/4	1-7/8	15
5		5/16	6-7/8	2-1/4	24-1/2

Standard Package 5 Pieces.

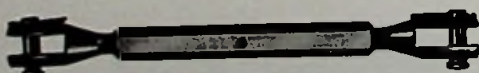

Fig. 398

**PETITE TURNBUCKLES—Fig. 398**  
Bronze – S.A.E. Threads – Jaw and Jaw

No.	Each	Diameter Thread Inches	Length Extended Inches	Takeup Inches	Width Jaws Inches	Weight Per 100 in Lbs.
4		1/4	5-3/4	1-7/8	1/4	19
5		5/16	6-7/8	2-1/4	1/4	28

Standard Package, 5 Pieces.

## DOUBLE END SCRAPERS—Fig. 1175

Fine Grade Tool Steel — Heat Treated

Each	Length Inches	Width Inches	Thick-ness Inches	Width Blade Inches	Standard Package	Weight Pounds
	15	1	1/4	1-3/4	5	1



Fig. 1175

## CAULKING IRONS—Fig. 307

Malleable Iron

Size No.	Each	Thickness Inches	Length Inches	Width Blade Inches	Weight Per Dozen in Lbs.
00		1/32	5	2	7-1/2
0		1/16	5-5/8	2-1/2	7-1/2
1		1/8	5-7/8	2-1/4	7-1/2



Fig. 307

Standard Package, 10 Pieces.

## SAIL MAKERS PALMS—Fig. 411

Hide Mounted — Right Hand Only

Per Dozen	Standard Package	Weight Per Dozen in Pounds
	12	2



Fig. 411

## MAPLE HAND FIDS—Fig. 923

For use in splicing ropes and light flexible cables, has a rounded end for hand use; varnished finish.

No.	Each	Size Inches	Standard Package	Weight Per Dozen Pounds
0		12x1-3/4	2	5-1/4
1		14x1-3/4	2	5-1/4
2		16x2	2	6-3/4
3		18x2	2	6-3/4
4		20x2-1/4	2	12



Fig. 923

## BRASS ACORN NUTS—Fig. 465

Milled Finish

No.	Size Thread	Plain Each	Polished Brass Each	Chromium Plated Each	Size Hexagon Inches	Height Inches
1	8 -32				5/16	5/16
2	1/4 -20				7/16	3/8
3	1/4 -20		N.A.	N.A.	7/16	3/4
4	5/16-18		N.A.	N.A.	5/8	5/8
5	3/8 -16		N.A.	N.A.	5/8	1
7	1/2 -13		N.A.	N.A.	3/4	1-3/8
8	1/2 -13				1	1
9	5/8 -11				1-1/8	1-3/16



Fig. 465

Standard Package, Sizes 1 thru 5, 10 Pcs. 7 thru 9, 5 Pcs.

## BRASS WING NUTS—Fig. 453

U. S. S. Thread

No.	For Diam. Bolt Inches	Threads Per Inch	Plain Brass Each	No.	For Diam. Bolt Inches	Threads Per Inch	Plain Brass Each
1	3/16	24		4	3/8	16	
2	1/4	20		5	1/2	13	
3	5/16	18					



Fig. 453

Standard Package, Sizes 1 thru 3, 10 Pcs. 4 & 5, 5 Pcs.



Fig. 565

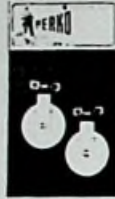

Fig. 565-SP

**TILLER ROPE PULLEY—Fig. 565**  
Swivel Type with Strap — For 1/4" Rope  
18-8 Stainless Steel — White Plastic Sheave

Complete Each	Length Overall Inches	Diam. Sheave Overall Inches	Length Strap Inches	Standard Package	Weight Ounces
	3-3/4	2-5/16	1-5/8	10	2



**SKIN PACK — Fig. 565-SP**  
One Pair Per Card.  
Twelve Cards Per Box.  
Weight Per Box, 4½ Pounds.

Sold To Trade In Full Box Only.



Fig. 634

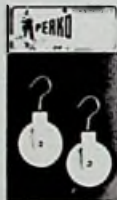

Fig. 634-SP

**TILLER ROPE PULLEY—Fig. 634**  
Swivel Snap Hook Type — For 1/4" Rope  
18-8 Stainless Steel — White Plastic Sheave

Complete Each	Length Overall Inches	Snap Throat Opening Inches	Diam. Sheave Overall Inches	Standard Package	Wt. Ozs.
	4-5/8	1/2	2-5/16	10	2-1/2



**SKIN PACK — Fig. 634-SP**  
One Pair Per Card.  
Twelve Cards Per Box.  
Weight Per Box, 5¼ Pounds:

Sold To Trade In Full Box Only.



Fig. 1255

**TILLER ROPE PULLEY—Fig. 1255**  
Coaming Type — White Plastic Sheave  
Die Cast Zinc Alloy — Chromium Plated

No.	Each	Diam. Sheave Inches	For Diam. Rope Inches	Dimensions of Plate Inches	Standard Package	Weight Ounces
2		2-5/16	1/4	4-7/8x1-1/4	10	2-1/2



Fig. 1256



Fig. 1261

**TILLER ROPE GUIDES—Figs. 1256 & 1261**  
Die Cast Zinc Alloy — Chromium Plated

Each	Size Hole Inches	Size Base Inches	For Screw No.	Weight Ounces	Standard Package
	5/16	1-1/4x3/4	6	1/2	25



Fig. 1243

**TILLER ROPE GUIDES—Fig. 1243**  
Die Cast Zinc Alloy — Chromium Plated

Each	For Diam. Rope Inches	Size Base Inches	For Screw No.	Weight Ounces	Standard Package
	1/4	2 x 3/4	8	1-3/4	10

**TILLER ROPE CLAMPS—Figs. 358 & 1226**  
For 1/8" and 3/16" Rope

Fig. 358—Pressure Cast Silicon Bronze.  
Fig. 1226—Die Cast Zinc Alloy.

Fig.	Natural Finish Each	Chromium Plated Each	Length Inches	Width Inches	Standard Package	Weight Ounces
358			1-1/4	11/16	20	1
1226			1-1/4	11/16	50	1



Fig. 358  
Fig. 1226

**SKIN PACK — Fig. 1226-SP**

Chromium Plated Finish.  
One Pair Per Card.  
Twelve Cards Per Box.  
Weight Per Box, 2½ Pounds.  
Sold To Trade In Full Box Only.



Fig. 1226-SP

**TILLER ROPE TIGHTENERS—Figs. 732 & 754**

Fig. 732-C —Steel, Cadmium Plated  
Fig. 732-SS —18-8 Stainless Steel  
Fig. 754 —Steel, Cadmium Plated

Fig.	Each	Normal Length Inches	Length Compressed Inches	Outside Diameter Inches	Standard Package	Weight Ounces
732-C	4	5	5	1	25	3-1/2
732-SS	4	5	5	1	10	2-1/4
754	4-3/4	6-1/2	6-1/2	7/8	25	3



Fig. 732-C  
Fig. 732-SS



Fig. 754

**SKIN PACK — Fig. 732-SP**

Stainless Steel or Cadmium Plated

Cadmium Plated Steel Per Pair	Stainless Steel Per Pair	Units Per Card	Units Per Box	Weight Per Box Pounds
		1 Pr.	12	5-1/2



Fig. 732-SP

Sold To Trade In Full Box Only.

**EYE STRAPS—Figs. 562 & 1242**

Fig. 562—18-8 Stainless Steel  
Fig. 1242—Die Cast Zinc Alloy — Chromium Plated

Fig.	Each	Length Inches	Size Eye Inches	For Screw No.	Weight Ounces	Standard Package
562		1-5/8	1/4	10	1/8	50
1242		1-7/8	5/16	8	1/4	50



Fig. 1242



Fig. 562

**EYE STRAPS—Fig. 881**

Forged Bronze — Very Strong

No.	Natural Bronze Each	Chromium Plated Each	Length Inches	Size Eye Inches	Stock in Eye Inches	For Screw No.	Wt. Ozs.
0			1-7/8	1/4	1/4	8	1/2
1			2-1/4	5/16	9/32	10	3/4
2			2-3/4	1/2	5/16	10	1-1/2



Fig. 881

Standard Package, Nos. 0 and 1, 50 pcs. No. 2, 25 pcs.



Fig 43

**FAST EYE BLOCKS—Fig. 43**

Galvanized Malleable Iron Or Bronze — Single

Size No.	Galv. Each	Plain Bronze Each	For Diam. Rope Inches	Size Sheaves Inches	Standard Package	Weight Pounds Each
1			3/16	3/4x5/16	10	3/32
3			1/4	1 x3/8	10	3/16
5			5/16	1-3/8x7/16	10	1/4
7			3/8	1-1/2x1/2	10	3/8
9		N.A.	7/16	1-3/4x9/16	5	1/2
11		N.A.	1/2	2 x5/8	5	5/8
13		N.A.	5/8	2-1/2x3/4	5	1-7/16
15		N.A.	3/4	3 x7/8	5	1-5/8



Fig. 51

**FAST EYE BLOCKS—Fig. 51**

Galvanized Malleable Iron — Double

Size No.	Each	For Diam. Rope Inches	Size Sheaves Inches	Standard Package	Weight Pounds Each
2		3/16	3/4x5/16	10	3/16
4		1/4	1 x3/8	10	1/4
6		5/16	1-3/8x7/16	10	3/8
8		3/8	1-1/2x1/2	10	5/8



Fig. 100

**SWIVEL EYE BLOCKS—Fig. 100**

Galvanized Malleable Iron Or Bronze — Single

Size No.	Galvanized Iron Each	Plain Bronze Each	For Diam. Rope Inches	Diameter Sheave Inches	Standard Package	Weight Per Doz. in Lbs.
0			3/16	1/2	10	1/2
1			3/16	3/4	10	1-1/4
3			1/4	1	10	2
5			5/16	1-3/8	10	2-7/8
7			3/8	1-1/2	10	4-7/8



Fig. 101

**SWIVEL EYE BLOCKS—Fig. 101**

Galvanized Malleable Iron — Double

Size No.	Each	For Diam. Rope Inches	Diameter Sheave Inches	Standard Package	Weight Per Doz. in Lbs.
00		3/16	1/2	10	1-1/16
2		3/16	3/4	10	2-1/4
4		1/4	1	10	3-3/8
6		5/16	1-3/8	10	4-1/2
8		3/8	1-1/2	10	7



Fig. 194

Side Pattern Single



Fig. 279

Upright Pattern Single

**WIRE ROPE PULLEYS—Figs. 194 & 279**

Galvanized Malleable Iron

Fig. 194 Single

Size No.	Each	For Diam. Rope Inches	Size Sheave Inches	Weight Pounds
1		3/16	2-1/2x3/8	1/2
2		1/4	3-1/4x1/2	1-1/4
3		5/16-3/8	4-1/2x5/8	2-1/2

Fig. 279 Single

Size No.	Each	For Diam. Rope Inches	Size Sheave Inches	Weight Pounds
10		3/16	2-1/2x3/8	5/8
20		1/4	3-1/4x1/2	1-1/2
30		5/16-3/8	4-1/2x9/16	2-1/2

**PERKO<sup>®</sup>**

**door & cabinet  
hardware  
locks  
latches  
bolts  
hinges  
hasps  
top fittings**

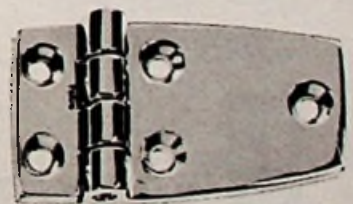
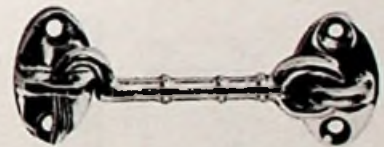
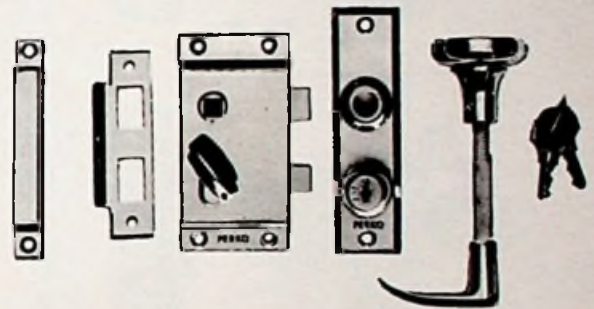

MANUFACTURED BY PERKO, INC., 16490 N.W. 13TH AVE., P.O. BOX 64000-D, MIAMI, FLORIDA 33164

FOR COMPLETE LINE SEE CATALOG NO. 230

### RIM LATCH SETS—Figs. 928 & 930

Die Cast Zinc Alloy – Chromium Plated

With round knob and lever handle, no keys. Locked by thumb bolt inside. For doors 3/4 to 1-1/2 inches.

Fig. 928—Regular Bevel With Box Strike.

Fig. 930—Reverse Bevel With Flush Strike.

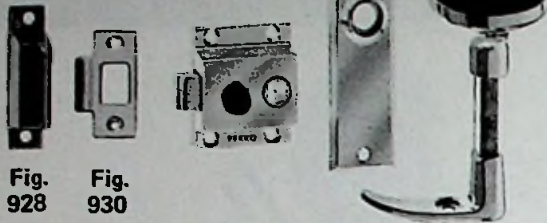

Per Set	Size Case Inches	Size Escutcheon Inches	Diameter Knob Inches	Backset Inches	Weight Pounds
	2-1/8x1-3/4	4-3/8x1-1/4	1-3/4	1-3/8	3/4

Spare Strike for Fig. 928, Specify Fig. 928-99A

Spare Strike for Fig. 930, Specify Fig. 930-99A

### MORTISE LATCH SETS—Fig. 960

Die Cast Zinc Alloy – Chromium Plated – Reversible

Locked by dead bolt inside, no keys, with round knob and lever handle. For door 1 to 1-1/2 inches thick.

Backset 1-3/8 inches.

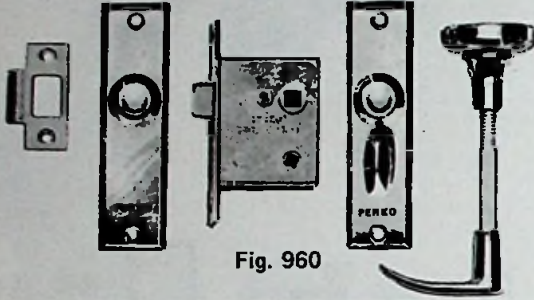

Per Set	Size Case Inches	Size Facing Inches	Size Escutcheon Inches	Diameter Knob Inches	Weight Pounds
	2-1/4x1-13/16	3-1/2x13/16	4-3/8x1-1/4	1-3/4	1

Spare Strike for Fig. 960, Specify Fig. 960-99A

### TUBULAR LATCH SETS—Fig. 567

Die Cast Zinc Alloy – Chromium Plated

Locked from inside by thumb bolt, no keys. Round knob and lever handle. For doors 1 to 1-1/2 inches thick.

Backset 1-1/4 inches.

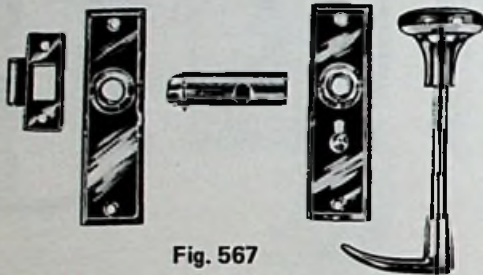

Per Set	Diameter Tube Inches	Size Escutcheon Inches	Diameter Knob Inches	Weight Pounds
	3/4	4-3/8x1-1/4	1-3/4	3/4

Spare Strike for Fig. 567, Specify Fig. 567-99-A

### RIM LOCK SETS—Figs. 918 & 919

Die Cast Zinc Alloy – Chromium Plated

Five disc tumbler type with dead bolt for inside. With round knob and lever handle, two keys. For doors 3/4 to 1-1/2 inches.

Fig. 918—Regular Bevel With Box Strike.

Fig. 919—Reverse Bevel With Flush Strike.

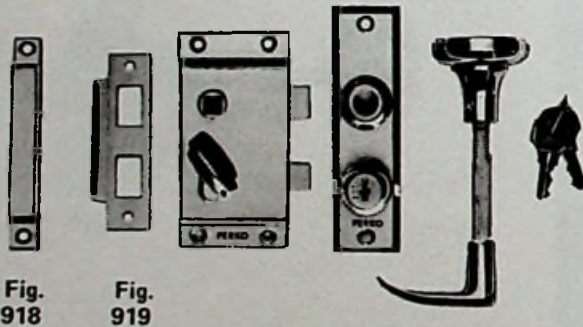

Per Set	Size Case Inches	Size Escutcheon Inches	Diameter Knob Inches	Backset Inches	Weight Pounds
	3-7/8x2	4-3/8x1-1/4	1-3/4	1-3/8	1-1/4

Spare Strike for Fig. 918, Specify Fig. 918-99-A

Spare Strike for Fig. 919, Specify Fig. 919-99A

Escutcheon with Tumbler Set and 2 Keys for Figs. 918 and 919, Specify Fig. 918-99-B

### MORTISE LOCK SETS—Fig. 927

Die Cast Zinc Alloy – Chromium Plated – Reversible

Five disc tumbler type with dead bolt for inside. With round knob and lever handle, two keys. For door 1 to 1-1/2 inches thick. Backset 1-3/8 inches.

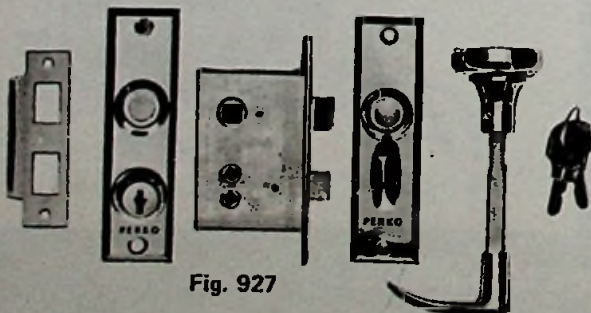

Per Set	Size Case Inches	Size Facing Inches	Size Escutcheon Inches	Diameter Knob Inches	Weight Pounds
	2-3/4x2	4x13/16	4-3/8x1-1/4	1-3/4	1-1/4

Spare Strike for Fig. 927, Specify Fig. 927-99A

Escutcheon with Tumbler Set and 2 Keys for Fig. 927, Specify Fig. 927-99-B

Spare Knob, Lever Handle and Spindle Assembly for All Above – Specify Fig. 962



**ONE-WAY NIGHT OR SAFETY LATCH—Fig. 948**

Die Cast Zinc Alloy — Chromium Plated — With Sliding Safety Catch

Each	Dimensions Without Strike Inches	Weight Ounces
	2-1/8x1-3/4	5

Standard Package, 5 Pieces.

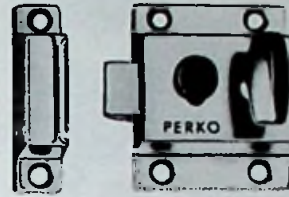

Fig. 948

**HEAVY DUTY CUPBOARD TURNS—Fig. 978**

Die Cast Zinc Alloy — Chromium Plated  
High Quality in Design and Smooth Operation

Each	Dimensions Without Strike Inches	Weight Ounces
	2-1/8x1-3/4	5

Standard Package, 5 Pieces.

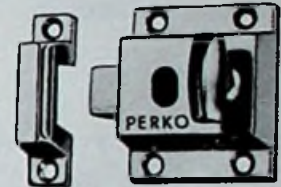

Fig. 978

**CUPBOARD CATCHES—Fig. 1102**

Die Cast Zinc Alloy — Chromium Plated

NO.	Each	Dimensions Without Strike Inches	Weight Ounces
1		1-1/2x1-3/8	3-1/2
2		1-1/2x1-3/8	3-1/2

No. 1 Supplied with Flush Strike

No. 2 Supplied with Offset Strike

Standard Package, 5 Pieces

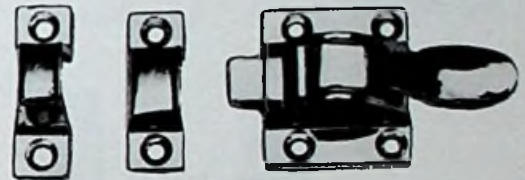

Flush

Fig. 1102

**SKIN PACK — Fig. 1102-SP**

One Catch Per Card

Supplied with Flush and Offset Strikes

Six Cards Per Box.

Weight Per Box, 1 Pound.

Sold To Trade In Full Box Only



Fig. 1102-SP

**CUPBOARD BOLT—Fig. 1101**

Die Cast Zinc Alloy — Chromium Plated

Each	Dimensions Without Strike Inches	Weight Ounces
	1-1/2x1-1/2	2

Standard package 5 pieces.

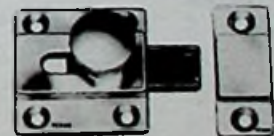

Fig. 1101

**SKIN PACK — Fig. 1101-SP**

One Bolt Per Card.

Six Cards Per Box.

Weight Per Box, 1 1/4 Pounds.

Sold To Trade In Full Box Only.

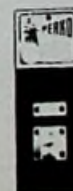

Fig. 1101-SP

**FLUSH RING CATCHES—Fig. 1051**

Die Cast Zinc Alloy — Chromium Plated — Phosphor Bronze Spring

Each	Size Inches	Standard Package	Weight Ounces
	1-3/4x1-3/8	10	1-1/2



Fig. 1051

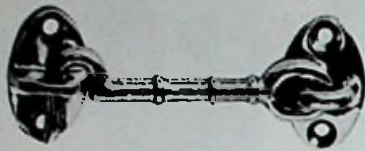

Fig. 956

**CABIN DOOR HOOKS—Fig. 956**  
Pressure Cast Silicon Bronze

No.	Length Hook Inches	Plain Bronze Each	Chromium Plated Each	Weight Ounces
1	1-1/2			1
2	2			1-1/2
3	2-1/2			1-3/4
4	3			2
5	3-1/2			2-1/2
6	4			3
7	5			3-1/2
8	6			5

Standard Package, 5 Pieces.

Spare Keepers, Specify Fig. 959 and Finish

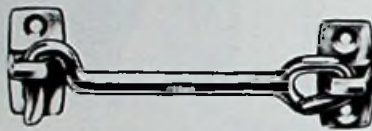

Fig. 1199

**CABIN DOOR HOOKS—Fig. 1199**  
Die Cast Zinc Alloy — Chromium Plated

No.	Length Hook Inches	Each	Weight Ounces
1	1-3/4		1-1/4
2	2-1/4		1-3/8
3	3		1-1/2
4	4		1-3/4

Spare Keepers, See Fig. 1261.  
Standard Package, 20 Pieces.



Fig. 1199-SP

**SKIN PACK — Fig. 1199-SP**

Size No. 1

One Hook Per Card.

Twelve Cards Per Box.

Weight Per Box, 2 Pounds.

Sold To Trade In Full Box Only.

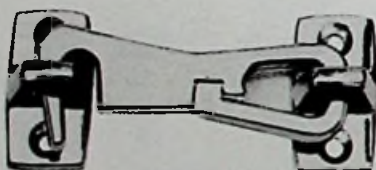

Fig. 1287

**MODERN DESIGN CABIN DOOR HOOKS—Fig. 1287**  
Patented.

Die Cast Zinc Alloy — Chromium Plated

No.	Length Hook Inches	Each	Dimensions Eye Plate Inches	Weight Ounces
1	2		1-1/4x11/16	1-1/4
2	2-1/2		1-1/4x11/16	1-1/2
3	3		1-1/4x11/16	1-3/4

Spare Keepers, See Fig. 1261.  
Standard Package, 20 Pieces.

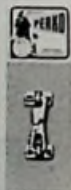

Fig. 1287-SP

**SKIN PACK — Fig. 1287-SP**

Size No. 2

One Hook Per Card

Six Cards Per Box

Weight Per Box, 13 Ounces

Sold To Trade In Full Box Only

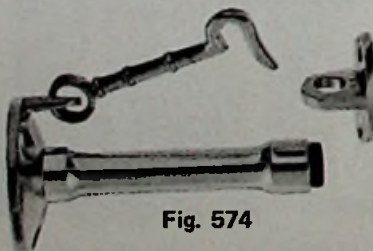

Fig. 574

**DOOR STOP AND HOLDER—Fig. 574**

Pressure Cast Silicon Bronze — Chromium Plated

No.	Each	Length Inches	Diameter Base Inches	Weight Ounces
1		2-3/8	1-3/4	4-1/2
2		3-1/4	1-3/4	5-1/2

Spare Keepers, Specify Fig. 959 Chrome.

## DOOR STOP—Fig. 1177

Rubber Bumper with Chromium Plated Holder

Each	Diameter Inches	Length Inches	Standard Package	Weight Ounces
	1-1/4	1	5	1



Fig. 1177

## DOOR HOLDERS—Fig. 1065

Stainless Steel Clip — Chromium Plated Arrow

Per Set	Base of Arrow Inches	Base of Clip Inches	Projection Inches	Weight Ounces
	1-5/8x3/4	1-3/8x7/16	1-3/4	2

Standard Package, 5 Sets.



Fig. 1065

## DOOR BUTTONS — Figs. 1216 & 1216-B

Die Cast Zinc Alloy — Chromium Plated — Black Plastic Knob

Eliminates rattling doors. Phosphor bronze coil spring under knob holds button against the plate. Drilled and countersunk for No. 6 screw.

	Each	Plate Diameter Inches	Width Less Keeper Inches	Standard Package	Weight Ounces
Fig. 1216		1-11/16	1-3/16	10	1-1/2
Fig. 1216-B		1-11/16	1-3/16	10	1-1/2



Fig. 1216  
With Spring



Fig. 1216-B  
Without Spring

## SKIN PACK — Fig. 1216-SP

With Spring

One Button Per Card.

Twelve Cards Per Box.

Weight Per Box, 1 1/4 Pounds.

Sold To Trade In Full Box Only.

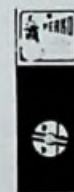

Fig. 1216 SP

## BARREL BOLTS—Fig. 947

Pressure Cast Silicon Bronze

No.	Plain Each	Chromium Plated Each	Length Rod Inches	Size Base Without Strike Inches	Weight Ounces
1			2-3/4	2-1/4x1-3/8	4
2			3	3 x1-1/4	4
3			4	4 x1-3/8	5

Standard Package, 5 Pieces.

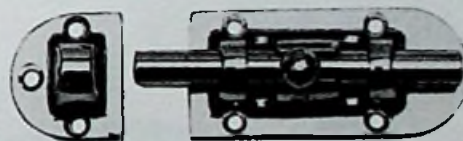

Fig. 947

## SKIN PACK — Fig. 947-SP

Size No. 2 — Chromium Plated

One Bolt Per Card.

Five Cards Per Box.

Weight Per Box, 1 1/2 Pounds.

Sold To Trade In Full Box Only.



Fig. 947-SP

## SHIP BOLTS—Fig. 1053

Pressure Cast Silicon Bronze — Chromium Plated

Each	Size Without Strike Inches	Weight Ounces
	2-3/8x1-1/4	1-3/4

Standard Package, 5 Pieces.



Fig. 1053



Fig. 560



**MAGNETIC DOOR CATCH – Fig. 560**

For cupboard and locker doors — special corrosion resistant finish prevents rusting.

Each	Catch Size Inches	Weight Ounces	Std. Pkg.
	1-7/8 x 1/2	1/2	25



Fig 1056

**ELBOW CATCHES—Fig. 1056**

Die Cast Zinc Alloy — Chromium Plated

Each	Size Base Inches	Standard Package	Weight Ounces
	1-1/8x9/16	10	3/4

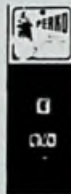

Fig. 1056-SP

**SKIN PACK – Fig. 1056-SP**

One Catch Per Card.  
Twelve Cards Per Box.  
Weight Per Box, 1 Pound.

Sold To Trade In Full Box Only.

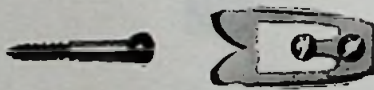

Fig 554

**“FLEXA” DOOR CATCHES—Fig. 554**

White Nylon Catch — Stainless Steel Spring — With Brass, Chromium Plated Screws — Positive Grip — 18 Pound Pull

Each Complete	Length Catch Inches	Length Ball Head Screw Inches	Standard Package	Weight Ounces
	1-3/16	3/4	25	1/4

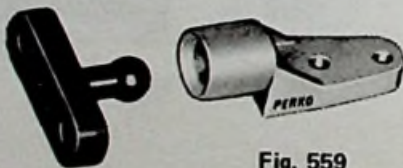

Fig. 559

**“POLYDEL” DOOR CATCHES—Fig. 559**

Grey Delrin Ball Stud — Polyethylene Catch — Holds Door Firmly in Place Against Vibration and Motion

Each	Stud Size Inches	Catch Size Inches	Standard Package	Weight Per 100 Pounds
	1-1/8x3/8	1-3/8x7/8	25	1



Fig. 559-SP

**SKIN PACK – Fig. 559-SP**

Two Catches Per Card.  
Twenty-Five Cards Per Box.  
Weight Per Box, 1 Pound.

Sold To Trade In Full Box Only.

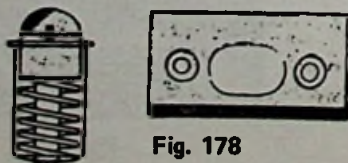

Fig. 178

**FRICITION CATCHES—Fig. 178**

All Brass — Adjustable Tension

Illustrations are full size. Supplied complete with oblong strike.

Per Set —

Standard Package, 10 Sets.

**FLUSH RING PULLS—Fig. 841**

Die Cast Zinc Alloy — Chromium Plated

Each	Size Plate Inches	Standard Package	Weight Ounces
	1-3/4x1-3/8	10	1



Fig. 841

**SKIN PACK — Fig. 841-SP**

One Pull Per Card  
Twelve Cards Per Box  
Weight Per Box, 1 Pound

Sold To Trade In Full Box Only



Fig. 841-SP

**FLUSH RING PULLS—Fig. 1103**

Pressure Cast Silicon Bronze — Chromium Plated

Each	Size Plate Inches	Standard Package	Weight Ounces
	2-9/16x2	5	3-1/2



Fig. 1103



Fig. 575

**FLUSH HATCH LIFTING RING—Fig. 575**

Safety Type — Pressure Cast Silicon Bronze  
No recess to catch heels, chair or table legs, etc.

Chromium Plated Each	Size Plate Inches	Inside Ring Inches	Standard Package	Weight Ounces
	2-5/8x2	1	5	3

**SKIN PACK — Fig. 575-SP**

One Ring Per Card  
Twelve Cards Per Box  
Weight Per Box, 1½ Pounds

Sold To Trade In Full Box Only



Fig. 575-SP

**FLUSH HATCH LIFTING HANDLE—Fig. 1220**

Die Cast Zinc Alloy — Chromium Plated  
No large recess to catch chairs, heels, table legs, etc.

Each	Dimensions Plate Inches	Inside Handle Inches	Standard Package	Weight Ounces
	3x2-1/4	1-7/8x1	5	3

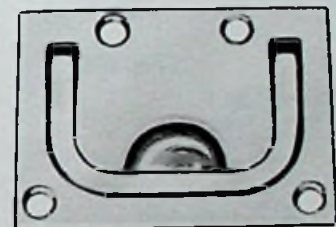

Fig. 1220

**SKIN PACK — Fig. 1220-SP**

One Handle Per Card  
Ten Cards Per Box  
Weight Per Box, 2½ Pounds

Sold To Trade In Full Box Only

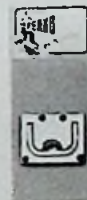

Fig. 1220-SP

**HEAVY DUTY FLUSH HATCH LIFTING HANDLE—Fig. 776**

Pressure Cast Silicon Bronze — Stainless Steel Pin

No.	Burnished Each	Chromium Plated Each	Dimensions Plate Inches	Inside Handle Inches	Weight Ounces
1			3 x 2-1/4	1-7/8 x 1	3-1/2
2			3-3/4 x 2-3/4	2-3/16 x 1-3/16	5-1/2

Size No. 1 Same Appearance as Fig. 1220

Illustration is Size No. 2

Standard Package, 5 Pieces.

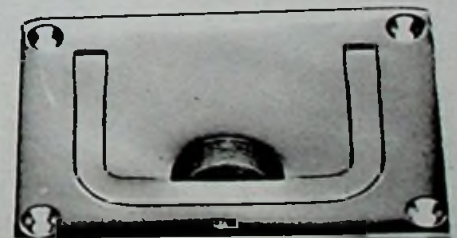

Fig. 776

**SKIN PACK — Fig. 776-SP**

No. 1 Chromium Plated  
One Handle Per Card  
Six Cards Per Box

Weight Per Box, 1¼ Pounds

Sold To Trade In Full Box Only

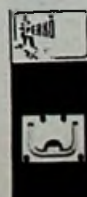
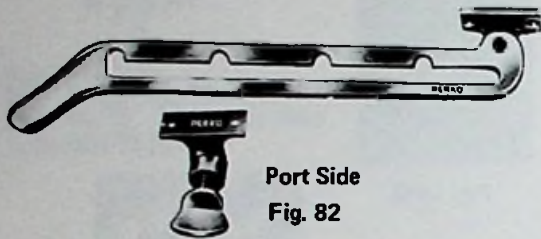

Fig. 776-SP



Side Mounting  
Fig. 1290

Offset Mounting  
Fig. 1291



Port Side  
Fig. 82

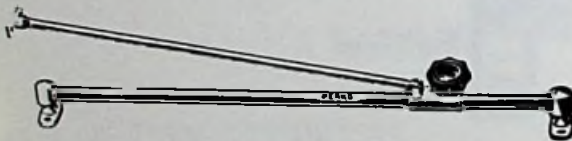

Fig. 360

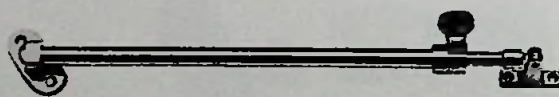

Fig. 1179

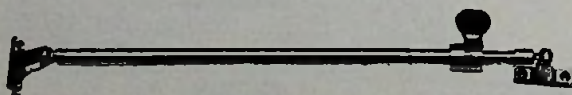

Fig. 1180

**WINDSHIELD ADJUSTERS—Figs. 1290 & 1291**  
Die Cast Zinc Alloy — Chromium Plated

Per Pair	Length Overall Inches	Length Adjustment Inches	Diam. Knob Inches	Weight Per Pair Pounds
	12	9-1/2	1-3/4	1-1/2

Spare Arms with Mounting Bracket and Knob Specify Fig. 1290 99-A or Fig. 1291 99-A

Specify if Port or Starboard Side. Illustration is Port Side.

Spare Mounting Brackets with Knob Specify Fig. 1290-99B or Fig. 1291 99-B

Spare Knobs Specify Fig. 1292



**WINDSHIELD ADJUSTERS—Fig. 82**  
Bronze — Chromium Plated

Per Pair	Length Overall Inches	Length Adjustment Inches	Weight Per Pair Pounds
	12	9-1/2	2-3/8

NOTE — When ordering 1/2 pair, specify whether for port or starboard side.

Spare Thumb Screws, Specify Fig. 82-99 A.

Spare Arms with Base, Specify Fig. 82-99 B Specify Port or Starboard



**"SKIPPER" WINDSHIELD ADJUSTER—Fig. 360**  
Chromium Plated — For Heavy Cruiser Windshields

Enables the skipper to adjust the windshield with one hand without leaving the wheel. The large bakelite knob is used for pushing, pulling, tightening or loosening in one operation.

Each	Length Base Overall Inches	Length Windshield Arm Inches	Length of Adjustment Inches	Weight Pounds
	27-1/2	23	22-1/2	3-3/4

Spare Knobs, Specify Fig. 360-99 A.

Spare Slide Body with Plastic Friction Pad. Specify, Fig. 360-99 B.

Spare End Stanchions, See Fig. 1297.

Special sizes to order, in manufacturing quantities only.



**WINDSHIELD ADJUSTERS—Fig. 1179**  
Heavy Pattern — Chromium Plated

Illustration shows swivel base on left side and swinging base on right.

No.	Each	Length Closed Inches	Length Open Inches	Diam. Outside Tube Inches	Weight Ounces
1		10	18	1/2	9
2		12	20	1/2	11

Spare Thumb Screws, Specify Fig. 1117.

Spare Swinging Base with Female Threaded Socket, Specify Fig. 1136.



**WINDSHIELD ADJUSTERS—Fig. 1180**  
Chromium Plated

A powerful non-slip grip keeps this adjuster in desired position.

Each	Length Closed Inches	Length Open Inches	Diam. Outside Tube Inches	Weight Ounces
	12	21	1/2	10

Spare Thumb Screws, Specify Fig. 1117.

Spare Swinging Base with Female Threaded Socket, Specify Fig. 1136.

Spare Swinging Base with Male Threaded Plug, Specify Fig. 1138.

## WINDSHIELD ADJUSTERS—Fig. 1116

Chromium Plated

No.	Each	Length Inches	Diam. Rod Inches	Weight Ounces
1		8	3/8	11
2		10	3/8	12
3		12	3/8	13

Spare Thumb Screws, Specify Fig. 1117.

Spare Swivel with Base and Set Screw, Specify Fig. 1116-99 A.



Fig. 1116

## HATCH ADJUSTERS—Fig. 797

Chromium Plated – Improved With Stop Teeth in Back of Slide.

Chromium Plated Each	Length Arm Inches	Length Adjustment Inches	Length Slide Inches	Weight Ounces
	10	9-1/2	10-3/4	13

Spare Knobs, Specify Fig. 1292.



Fig. 797

## HATCH FASTENERS OR WINDSHIELD KEEPER—Fig. 155

Brass – Chromium Plated – With Phosphor Bronze Internal Spring

This fastener has strong spring action providing quick grip or release.

Each	Length Overall Inches	Size of Mounting Inches	Standard Package	Weight Ounces
	3-7/8	1-1/2x9/16	5	3-1/4



Fig. 155

## WINDSHIELD KEEPER OR HATCH FASTENER—Fig. 697

Chromium Plated

Per Set	Base of Keeper Inches	Base of Plate Inches	Standard Package	Weight Ounces
	1-1/2x5/8	1-1/2x3/4	10	3

A set consists of parts illustrated.



Fig. 697



## HATCH FASTENER OR WINDSHIELD KEEPER—Fig. 769

Chromium Plated

Each	Dimensions For Each Base Inches	Standard Package	Weight Ounces
	1-1/2x5/8	10	4-1/2

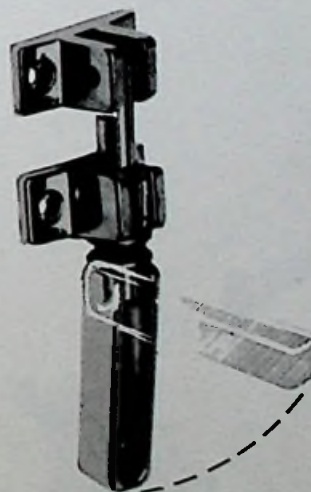

Fig. 769



Fig. 967

## WINDSHIELD KEEPER OR HATCH FASTENER—Fig. 967

Cast Bronze – Chromium Plated

Per Set	Base of Keeper Inches	Base of Plate Inches	Length Bolt Inches	Standard Package	Weight Ounces
	1-9/16x1	1-7/8x7/8	1-1/4	5	6

Fig. 1112



Fig. 1113

Fig. 1112-SP  
Fig. 1113-SP



**HATCH HOLD-DOWN CLAMPS—Figs. 1112 & 1113**

Pressure Cast Silicon Bronze — Polished Chromium Plated

An excellent item with many uses, on hatch covers, wind-shields, windows, bait and fish boxes, etc.

Flat Mounting Fig. 1112

Each	Length Inches	Width Inches	Standard Package	Weight Ounces
	3	1-1/2	5	5-1/2

Spare Keepers, Specify Fig. 1112-99 A.

Angle Mounting Fig. 1113

Each	Length Inches	Width Inches	Standard Package	Weight Ounces
	2-1/2	1-1/2	5	5-1/2

Spare Keepers, Specify Fig. 1113-99 A.



SKIN PACK — Fig. 1112-SP

SKIN PACK — Fig. 1113-SP

One Clamp Per Card

Three Cards Per Box

Weight Per Box, 1 1/4 Pounds

Sold To Trade In Full Box Only



**ANTI-RATTLE DOOR OR HATCH FASTENER—Fig. 1108**

Pressure Cast Silicon Bronze — Chromium Plated

Has 1/4 inch hole in lever for padlock.

Each	Size Base Inches	Standard Package	Weight Ounces
	2-3/4x1-3/4	5	4

Spare Keepers, Specify Fig. 1108-99 A.



**HATCH SUPPORT HINGES—Fig. 762**

Brass — Chromium Plated

No.	Length Open Inches	Per Pair	For Screw No.	Weight Per Pair Ounces
1	10	10	8	10
2	12	12	8	12
3	14	14	8	14

Fig. 762



**SASH OR HATCH FASTENERS—Fig. 770**

Pressure Cast Silicon Bronze — Stainless Steel Pin

Chromium Plated Each	Extreme Length Overall Inches	Width Inches	Length Thread Inches	Standard Package	Weight Ounces
	3-3/4	1-5/8	2-1/4	5	6

Spare Knurled Nut, Specify Fig. 770-99 A.

Spare Keeper, Specify Fig. 770-99 B.



Fig. 770



## SLIDING WINDOW HANDLE—Fig. 954

18-8 Stainless Steel — Polished — For 1/4 Inch Glass

A useful handle made for easier operation of sliding windows.

Each	Length Inches	Standard Package	Weight Ounces
	3	5	1



Fig. 954

---

## SLIDING WINDOW STOP—Fig. 935

Die Cast Zinc Alloy — Chromium Plated

Each	Mounting Plate Inches	Stopping Plate Inches	Standard Package	Weight Ounces
	1-7/8x3/4	1-1/2x3/4	5	2



Fig. 935

---

## SLIDING WINDOW LOCK AND ANTI RATTLER—Fig. 937

Die Cast Zinc Alloy — Chromium Plated — Bakelite Knob  
Plastic Tip

Each	Height Overall Inches	Mounting Plate Inches	*Length Screw Inches	Standard Package	Weight Ounces
	1-5/8	1x5/8	1-1/8	5	1-1/4



Fig. 937

\*Between Knob and Tip

Spare Knobs, Specify Fig. 943.  
Spare Plastic Tips, Specify Fig. 944.

---

## SKIN PACK — Fig. 937-SP

Two Locks Per Card  
Six Cards Per Box  
Weight Per Box, 2 Pounds  
Sold To Trade In Full Box Only



Fig. 937-SP

---

## SLIDING WINDOW LOCK AND ANTI-RATTLER—Fig. 934

Die Cast Zinc Alloy — Chromium Plated — Bakelite Knob  
Plastic Tip

Each	Height Overall Inches	Dimensions Base Inches	*Length Screw Inches	Standard Package	Weight Ounces
	1	2x5/8	1-1/8	5	1-1/4



Fig. 934

\*Between knob and tip.

Spare Knobs, Specify Fig. 943.  
Spare Plastic Tips, Specify Fig. 944.

---

## TABLE LEG FASTENERS—Fig. 719

Brass — For Fastening Table Leg To Deck

Chromium Plated Each	Length Angle Inches	Width Angle Inches	Standard Package	Weight Ounces
	1-3/8	1	5	3



Fig. 719

Spare Thumb Screws, Specify Fig. 719-99 A.  
Spare Angle Brackets, Specify Fig. 719-99 B.

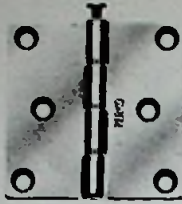

Fig. 1293



Fig. 1293-SP



Fig. 952

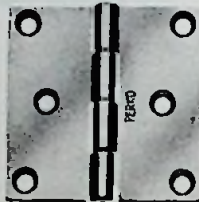

Fig. 949

## BUTT HINGES—Fig. 1293

Die Cast Zinc Alloy — Chromium Plated  
Stainless Steel Removable Pin and Nylon Spacers —  
Smooth Operation

No.	Per Pair	Size Open Inches	For Screw No.	Weight Per Pair Ounces
2		1-1/2 x 1-1/2	8	2
3		2 x 1-1/2	8	2-1/2
4		2 x 2	8	3
5		2-1/2 x 2	8	4-1/2
6		2-1/2 x 2-1/2	8	5
7		3 x 3	10	7-1/2

Sizes 2-3-4 have 4 Screw Holes — Sizes 5-6-7 have 6 Screw Holes.  
Standard Package, 5 Pairs.

## SKIN PACK — Fig. 1293-SP

Size No. 4 — 2"x2"

One Pair Per Card

Ten Cards Per Box

Weight Per Box, 2 1/4 Pounds

Sold To Trade In Full Box Only.

## BUTT HINGES— Figs. 952 & 949

Heavy Gauge Wrought Brass

Fig. 952 Has A Removable Pin

Fig. 949 Has A Fast Pin

No.	Plain Brass Per Pair	Chromium Plated Per Pair	Size Open Inches	For Screw No.	Standard Package	Weight Per Pair Ounces
1			1-1/2 x 1-1/4	8	5 Prs.	2
2			1-1/2 x 1-1/2	8	5 Prs.	2-1/2
3			2 x 1-1/2	8	5 Prs.	2-3/4
4			2 x 2	8	5 Prs.	4
5			2-1/2 x 2	8	1 Pr.	5
6			2-1/2 x 2-1/2	8	1 Pr.	6-3/4
7			3 x 3	10	1 Pr.	9-1/2

Sizes 1-2-3-4 have 4 Screw Holes — Sizes 5-6-7 have 6 Screw Holes.

## STRAP HINGES—Fig. 120

Pressure Cast Silicon Bronze — Stainless Steel Pin

No.	Burnished Per Pair	Chromium Plated Per Pair	Length Open Inches	Width At Pin Inches	Standard Package	Weight Per Pair Ounces
1			4	1-1/16	5 Prs.	4
2			6	1-1/8	5 Prs.	6
3			8	1-3/16	1 Pr.	14



Fig. 120

## SHORTSIDE STRAP HINGES—Fig. 122

Pressure Cast Silicon Bronze — Stainless Steel Pin

Length Open Inches	Chromium Plated Per Pair	Width Inches	For Screw No.	Weight Per Pair Ounces
4-7/8		1-7/8	10	5

Dimension "A" to Center of Pin 2"

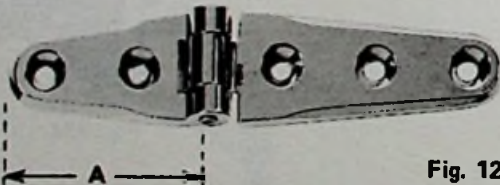

Fig. 122

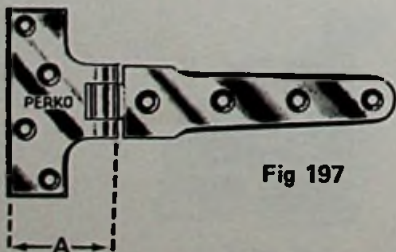

Fig. 197

## "T" HINGES—Fig. 197

Cast Bronze — Stainless Steel Pin

No.	Burnished Per Pair	Chromium Plated Per Pair	Length Open Inches	Width Overall Inches	"A" Inches	Standard Package	Weight Per Pair Pounds
1			4	2-1/8	1-3/16	5 Prs.	1/2
2			6	3	1-1/2	1 Pr.	7/8
3			8	3-7/8	2	1 Pr.	1-1/2

BUY STANDARD PACKAGES

## CUDDY DOOR HINGES—Fig. 808

Die Cast Zinc Alloy — Chromium Plated  
With Stainless Steel Pin

Per Pair	Length Open Inches	Extreme Width Inches	For Screw No.	Weight Per Pair Ounces
	3	1-1/2	8	3-1/2

Standard Package, 5 Pairs.



Fig. 808

## SKIN PACK — Fig. 808-SP

One Pair Per Card

Ten Cards Per Box

Weight Per Box, 2 3/4 Pounds

Sold To Trade In Full Box Only



Fig. 808-SP

## HEAVY DUTY CUDDY DOOR HINGES—Fig. 951

Pressure Cast Silicon Bronze — Chromium Plated  
18-8 Stainless Steel Pin

No.	Length Open Inches	Per Pair	Width Inches	For Screw No.	Weight Per Pair Ounces
1	3		1-1/2	8	3-1/2
2	4		1-1/2	8	5-1/2

Standard Package, 5 Pairs.

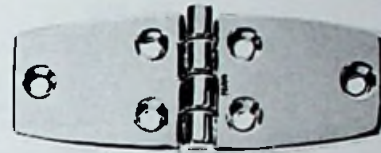

Fig. 951

## HEAVY DUTY CABINET HINGES—Figs. 987 & 1213

Pressure Cast Silicon Bronze or Die Cast Zinc Alloy  
Surface Type — 18-8 Stainless Steel Pin

Fig. No.	Length Open Inches	Chromium Plated Per Pair	Width Inches	For Screw No.	Weight Per Pair Ounces
987 1	2-1/4		1-1/2	8	3-1/2
987 2	2-3/4		1-1/2	8	4
1213 1	2-1/4		1-1/2	8	3

Dimension "A" — 9/16"

Standard Package, 5 Pairs.

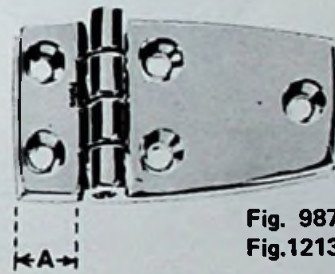

Fig. 987 — Bronze  
Fig. 1213 — Die Cast

## HEAVY DUTY CABINET HINGES—Figs. 988 & 1214

Pressure Cast Silicon Bronze or Die Cast Zinc Alloy  
3/8" Offset Type — 18-8 Stainless Steel Pin

Fig. No.	Length Open Inches	Chromium Plated Per Pair	Width Inches	For Screw No.	Weight Per Pair Ounces
988 1	2-1/4		1-1/2	8	4
988 2	2-3/4		1-1/2	8	5
1214 1	2-1/4		1-1/2	8	4

Dimension "A" — 11/16"

Standard Package, 5 Pairs.

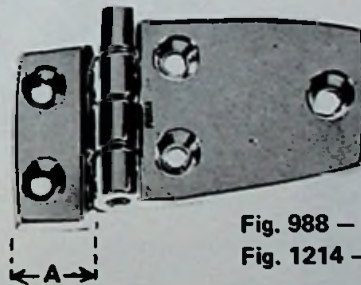

Fig. 988 — Bronze  
Fig. 1214 — Die Cast

## HEAVY DUTY SHORTSIDE HINGES—Fig. 999

Pressure Cast Silicon Bronze — Chromium Plated  
18-8 Stainless Steel Pin

Length Open Inches	Per Pair	Width Inches	For Screw No.	Weight Per Pair Ounces
3-1/2		1-1/2	8	5

Dimension "A" — 1-5/16"

Standard Package, 5 Pairs.

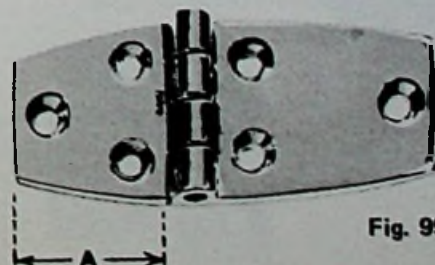

Fig. 999

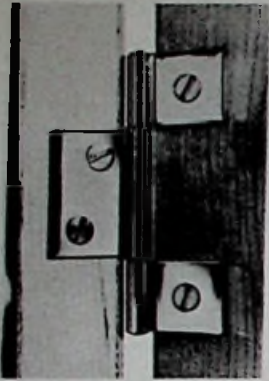

Fig. 957



Fig. 924



Fig. 924-SP



Fig. 1058



Fig. 929

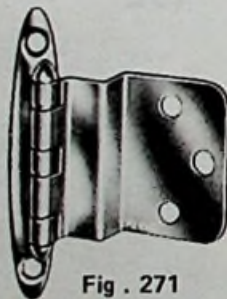

Fig. 271

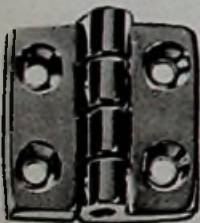

Fig. 941

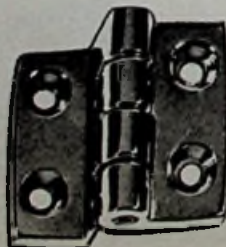

Fig. 942

**NEW**

**NON-MORTISED HINGE—Fig. 957**

Heavy Gauge Wrought Brass — Fast Pin — Chromium Plated Reversible, does not require mortising. Reduces installation cost.

Per Pair	Pin Length Inches	Width Closed Inches	For Screw No.	Std. Pkg.	Weight Per Pair
	3-3/8	7/8	8	5 pr	4 oz

**CUDDY DOOR HINGES—Fig. 924**

Wrought Brass — Thickness .051 Inches — Stainless Steel Pin

Chromium Plated Per Pair	Length Open Inches	Extreme Width Inches	Standard Package	Weight Per Pair Ounces
	3	1-1/2	5 Pairs	2-1/2

**SKIN PACK — Fig. 924-SP**

One Pair Per Card

Twelve Cards Per Box

Weight Per Box, 2 Pounds

Sold To Trade In Full Box Only

**BUTTERFLY HINGES—Fig. 1058**

Wrought Brass

No.	Length Open Inches	Width at Pin Inches	Thickness Inches	Weight Per Pair Ounces
1	2-1/4	3/4	.040	1/2
2	3	1-1/16	.045	1-1/2

Standard Package, 10 Pairs.

**FLAP HINGES—Fig. 929**

Stainless Steel — Polished — Thickness .050 Inches

Per Pair	Length Open Inches	Extreme Width Inches	Standard Package	Weight Per Pair Ounces
	2-1/16	3/4	10 Pairs	1

**“SEMI-CONCEALED” HINGE—Fig. 271**

Wrought Brass — Chromium Plated

For use on doors with 3/8" inset.

Per Pair	Dimensions Overall Inches	Standard Package	Weight Per Pair Ounces
	2-3/4x2-1/8	10 Pairs	2-1/2

**HEAVY DUTY CABINET HINGES — Fig. 941**

Die Cast Zinc Alloy — Chromium Plated with Stainless Steel Pin — Surface Type

Per Pair	Size Open Inches	For Screw No.	Weight Per Pair Ounces
	1-1/2x1-1/2	8	2-1/4

Dimension "A" — 1/2"

Standard Package, 5 Pairs

**HEAVY DUTY CABINET HINGES — Fig. 942**

Die Cast Zinc Alloy — Chromium Plated with Stainless Steel Pin — 3/8" Offset Type

Per Pair	Size Open Inches	For Screw No.	Weight Per Pair Ounces
	1-1/2x1-1/2	8	2-1/2

Dimension "A" — 9/16"

Standard Package, 5 Pairs

### "PULL-OUT" HINGE—Fig. 149

Pressure Cast Silicon Bronze — Chromium Plated

Left Hand

Each	Length Inches	Width at Pin Inches	Standard Package	Weight Ounces
	3-3/4	2	2	5-1/2

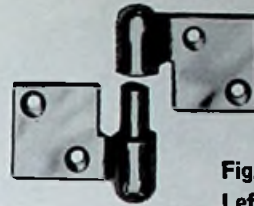

Fig. 149  
Left Hand

### "PULL-OUT" HINGE — Fig. 152

Pressure Cast Silicon Bronze — Chromium Plated

Right Hand

Each	Length Inches	Width at Pin Inches	Standard Package	Weight Ounces
	3-3/4	2	2	5-1/2

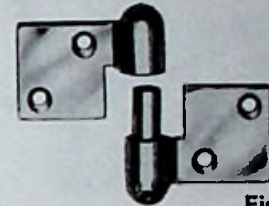

Fig. 152  
Right Hand

### HATCH HINGES—Fig. 773

Cast Bronze

For use with flush hatch cover.

Burnished Per Pair	Chromium Plated Per Pair	Length Inches	Width Overall Inches	Weight Per Pair Pounds
		3-1/8	2-5/8	1-5/8

Illustration shows one half pair.



Fig. 773

### CONTINUOUS HINGE—Figs. 211 & 212

For use on Hatch Covers, Locker Doors, Windshields, etc.

Countersunk holes are two inches apart, center to center.

#### BRASS — FIG. 211

No.	Chromium Plated Each	Width Open Inches	Length Inches	Thickness Inches	For Screw No.	Weight Pounds
2		1-1/4	72	.040	5	1-1/2
4		1-1/2	72	.040	5	2
6		2	72	.045	6	2-1/2

Standard Package, 10 Pieces. Minimum Quantity, No Broken Packages.



Brass, Chromium Plated — Fig. 211  
Stainless Steel, Polished — Fig. 212

#### STAINLESS STEEL — FIG. 212

Type No. 304, 18-8, Polished

No.	Each	Width Open Inches	Length Inches	Thickness Inches	For Screw No.	Weight Pounds
2		1-1/4	72	.040	6	1-1/3
4		1-1/2	72	.040	6	2

Standard Package 10 Pieces. Minimum Quantity, No Broken Packages.

### FLAT HATCH TRIM—Figs. 243 & 258

For finishing around edges of hatch. Drilled and countersunk off center for No. 6 flat head screws.

#### BRASS — FIG. 243

No.	Chromium Plated Each	Width Inches	Length Inches	Thickness Inches	*Standard Package	Weight Pounds
2		1-1/4	72	.040	10	1
4		1-1/2	72	.040	10	1-1/2

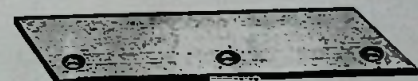

Brass, Chromium Plated — Fig. 243  
Stainless Steel, Polished — Fig. 258

#### STAINLESS STEEL — FIG. 258

Type 304-18-8 — Polished

No.	Each	Width Inches	Length Inches	Thickness Inches	*Standard Package	Weight Pounds
2		1-1/4	72	.040	10	1
4		1-1/2	72	.040	10	1-1/2

\*Above Standard Package Is Minimum. No Broken Packages.



Fig. 958



Fig. 925

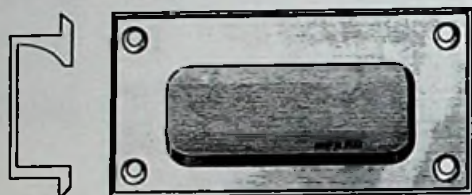

Fig. 1110



Fig. 975



Fig. 610

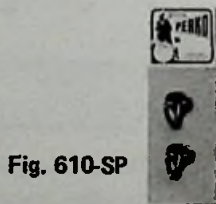

Fig. 610-SP



Fig. 1106

**DRAWER PULLS—Fig. 958**

Die Cast Zinc Alloy — Chromium Plated

Each	Width Overall Inches	Width Inside Inches	Standard Package	Weight Ounces
	3-7/16	2-5/16	10	1



**DRAWER KNOBS—Fig. 925**

Brass — Chromium Plated —  
For Drawers Up To 1-1/8" Thick

Each	Diameter Inches	Standard Package	Weight Ounces
	1	10	1-1/2



**FLUSH PULLS—Fig. 1110**

Die Cast Zinc Alloy — Chromium Plated — For Drawers, Sash Or Sliding Doors

Each	Dimensions Overall Inches	Depth Inches	Standard Package	Weight Ounces
	3-11/16x1-11/16	7/16	5	3

Inside recessed for finger grip as illustrated.



**COAT AND HAT HOOK—Fig. 975**

Die Cast Zinc Alloy — Chromium Plated

No.	Each	Projection Inches	Width Base Inches	Standard Package	Weight Ounces
1		2	1-1/8	10	1
2		3	1-1/4	10	1-1/2



**WARDROBE OR UTILITY HOOK — Fig. 610**

Die Cast Zinc Alloy — Chromium Plated

Each	Projection Inches	Width Base Inches	Standard Package	Weight Ounces
	1-3/8	1-1/8	10	1/2



**SKIN PACK — Fig. 610-SP**

Two Hooks Per Card.

Six Cards Per Box.

Weight Per Box, 10 Ounces.

Sold To Trade In Full Box Only.



**WARDROBE HOOK—Fig. 1106**

Die Case Zinc Alloy — Chromium Plated

Each	Projection Inches	Width Base Inches	Standard Package	Weight Ounces
	3/4	1	10	3/4

**SECURITY HINGED HASPS – Fig. 998**  
 Pressure Cast Silicon Bronze – Chromium Plated  
 18-8 Stainless Steel Pin

No.	Each	Length Closed Inches	Width Inches	Weight Ounces
1		2	1	2
2		3	1	3

Spare Keepers, Specify Fig. 959, Chrome.  
 Standard Package, 10.



Fig. 998

**SECURITY HINGED HASPS—Fig. 979**

Wrought Brass – 14 B. & S. Gauge

Polished Brass Each	Chromium Plated Each	Length Closed Inches	Width Inches	Standard Package	Weight Ounces
		2-7/8	1	10	1-1/4



Fig 979

**SECURITY HINGED HASPS—Fig. 1198**  
 Die Cast Zinc Alloy – Chromium Plated

No.	Each	Length Closed Inches	Width Inches	Standard Package	Weight Ounces
1		2	1	10	1-1/2
2		3	1	10	2-1/4
3		3-3/4	1	10	2-1/2

Spare Keepers, See Fig. 1261



Fig. 1198

**SKIN PACK – Fig. 1198-SP**

Size No. 2  
 One Hasp Per Card.  
 Twelve Cards Per Box.  
 Weight Per Box, 2½ Pounds.  
 Sold To Trade In Full Box Only.



Fig. 1198-SP

**HINGED LOCKING HASP—Fig. 1194**  
 Die Cast Zinc Alloy – Chromium Plated  
 Padlock eye swivels to act as a latch.

Each	Length Closed Inches	Width Inches	Standard Package	Weight Ounces
	3	1	10	2-1/2

Spare Keepers, Specify Fig. 1194-99 A.

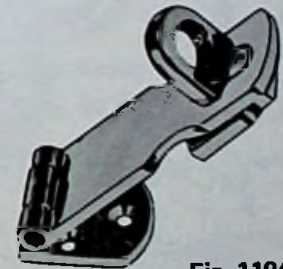

Fig. 1194

**SKIN PACK – Fig. 1194-SP**

One Hasp Per Card.  
 Five Cards Per Box.  
 Weight Per Box, 1¼ Pounds.  
 Sold To Trade In Full Box Only.



Fig. 1194-SP

**LADDER HINGES—Fig. 556**

Cast Manganese Bronze – Chromium Plated

Per Pair	Length Open Inches	Width Inches	Standard Package	Weight Per Pair Ounces
	5-3/4	3/4	1 Pair	8

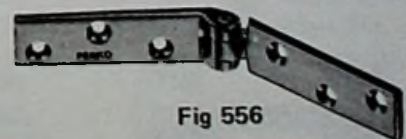

Fig 556



Fig. 1249

**LASHING HOOK—Fig. 1249**

For Boat Covers — Die Cast Zinc Alloy — Chromium Plated

Chromium Plated Each	Length Overall Inches	Width Overall Inches	Inside Hook Inches	For Screw No.	Standard Package	Weight Ounces
	15/16	1/2	1/4	6	50	1/2



**SKIN PACK — Fig. 1249-SP**

Six Hooks Per Card.

Ten Cards Per Box.

Weight Per Box, 2 1/4 Pounds.

Sold To Trade In Full Box Only.



Fig. 1249-SP

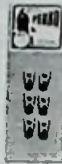

**BOAT COVER SOCKETS—Fig. 578**

Die Cast Zinc Alloy — Chromium Plated

Sockets will accommodate a piece of wood lattice 3/8 inches thick and up to 1-3/4 inches wide.

Per Pair	Length Overall Inches	Size Opening Inches	Width Overall Inches	For Screw No.	Weight Per Pair Ounces
	3-1/4	1-7/8x7/16	5/8	8	2

Standard Package, 10 Pairs.



**SKIN PACK — Fig. 578-SP**

One Pair Per Card.

Twelve Cards Per Box.

Weight Per Box, 3 Pounds.

Sold To Trade In Full Box Only.



Fig. 578-SP

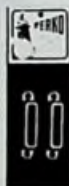

**CONVERTIBLE TOP FITTINGS—Fig. 395**

Die Cast Zinc Alloy — Chromium Plated

For 3/4 and 7/8 Inch Tubing

No.	Each	Item
1		Hinge for 3/4 inch fittings
3		Socket for 3/4 inch tubing
4		Eye End for 3/4 inch tubing with .065" Wall
5		Eye End for 3/4 inch tubing with .049" Wall
6		Slide for 3/4 inch tubing
8		Side Mounting Plate
9		Eye End for 7/8 inch tubing
10		Slide for 7/8 inch tubing
11		Hinge for 7/8 inch fittings

Standard Package 10 pieces.

Average Weight — 2 ounces each.



**SKIN PACK — Fig. 395-SP**

Part Nos. 1—3—6 Only

Two Fittings Per Card.

Six Cards Per Box.

Weight Per Box, 1 1/4 Pounds.

Sold To Trade In Full Box Only.

Fig. 395-SP



No. 1

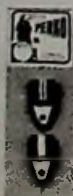

No. 3

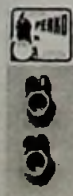

No. 6



Hinge Nos. 1-11



Eye End Nos. 4-5-9



Socket No. 3



Slide Nos. 6-10



Side Plate No. 8

Fig. 395



**ALL BRASS "DURABLE TYPE" FASTENERS**  
Nickel Plated

Stud Fig. 900 has brass 3/8" No. 7 wood screw.  
Stud Fig. 906 has steel 3/8" No. 7 self-tapping screw.  
Stud Fig. 917 has brass 8-32 machine screw 3/8" long.  
For canvas to wood, use Figs. 896, 898 and 900.  
For canvas to canvas, use Figs. 896, 898, 901 and 907.

Fig.	Per 100
896	
898	
900	
901	
906	
907	
917	

Standard Package, 100 Pieces, Minimum, No Broken Packages.



Button  
Fig. 896



Eyelet  
Fig. 907



STUD  
For Canvas  
Fig. 901



Socket  
Fig. 898



STUD  
With Wood Screw  
Fig. 900



STUD  
With Tapping Screw  
Fig. 906



STUD  
With Machine Screw  
Fig. 917

★  
**"LIFT TYPE" ALL BRASS FASTENERS**

Nickel Plated

Stud Figs. 114 & 115 have brass 3/8 inch No. 8 wood screw.  
Stud Fig. 90 has steel 3/8 inch No. 8 self tapping screw.  
Single Studs are used with one Fig. 116 and one Fig. 118.  
Double Studs are used with two Fig. 117 and two Fig. 118.

Fig.	Per 100
60	
62	
90	
114	
115	
116	
117	
118	

Standard Package, 100 Pieces, Minimum, No Broken Packages.



STUD  
With Wood Screw  
Single Fig. 114  
Double Fig. 115



STUD  
With Tapping Screw  
Single Fig. 90



Clinch Stud  
Single Fig. 60



Clinch Washer  
Fig. 62



SOCKET  
Single Fig. 116  
Double Fig. 117



Clinch  
Plate  
Fig. 118

★  
**ALL BRASS CURTAIN FASTENERS**

Nickel Plated

Stud Fig. 991, has brass 3/8" No. 7 wood screw.  
Single Studs used with one Fig. 996 and one Fig. 997.  
Double Studs used with two Fig. 996 and two Fig. 997.

Fig.	Per 100
991	
994	
995	
996	
997	

Standard Package, 100 Pieces, Minimum, No Broken Packages.



Flanged Stud  
Single Fig. 994  
Double Fig. 995



Screw Stud  
Single Fig. 991



Eyelet  
Fig. 996



Washer  
Fig. 997



# PERKO®

## FISHING EQUIPMENT

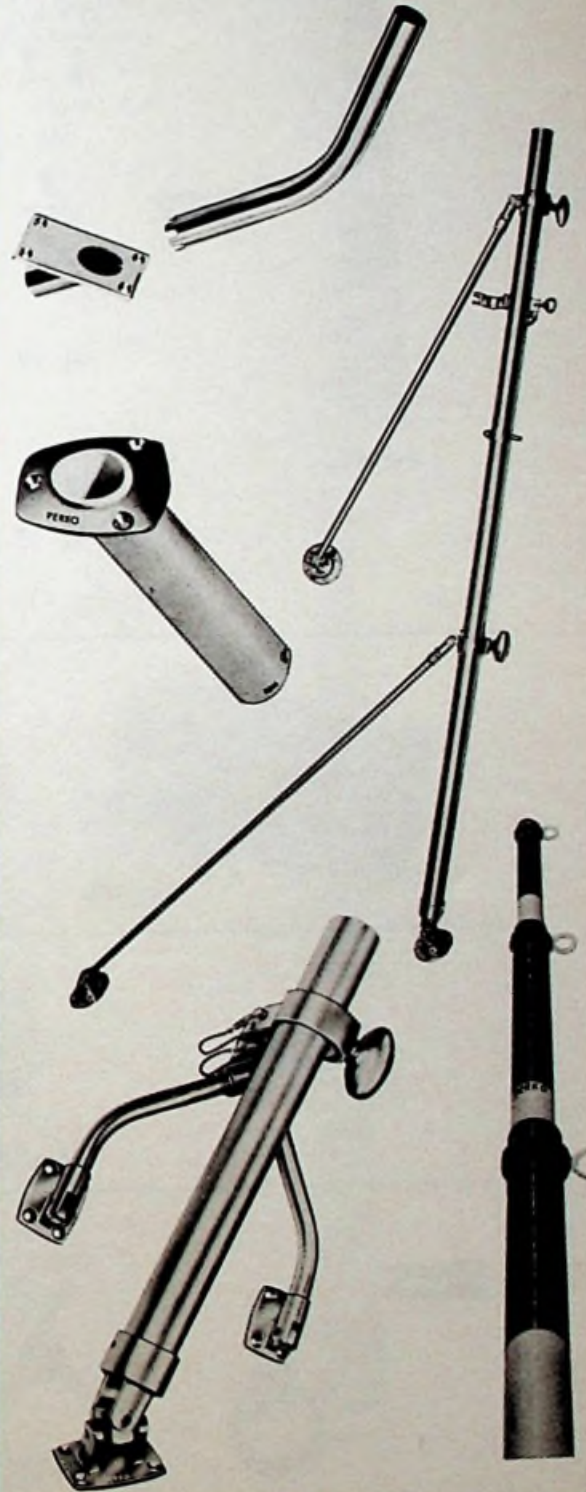

MANUFACTURED BY PERKO, INC., 16490 N.W. 13TH AVE., P.O. BOX 64000-D, MIAMI, FLORIDA 33164

FOR COMPLETE LINE SEE CATALOG NO. 230

PORTIONS OF THIS CATALOG PREVIOUSLY  
COPYRIGHTED IN 1936 THRU 1976 INCLUSIVE.



Fig. 460

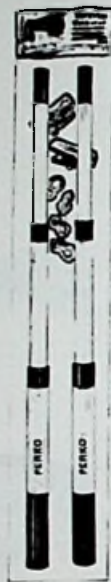

Fig. 476

**TELESCOPIC FIBERGLASS OUTRIGGERS—Fig. 460**  
 Complete with the IMPROVED Fig. 468 Guides  
 Hollow — Tapered — With Reinforced Joints

This sturdy model is impervious to heat, cold, moisture and sun. Base and tip are equipped with plugs.

No.	Diameter Base Inches	Overall Length Open Feet	Overall Length Closed Inches	Number of Sections	Weight Pounds
15	1.125	15	66	3	2½

Will Fit Holders, Figs. 444, 451 or 1314, Size No. 1.

**SPARE SECTIONS SPECIFY**

Top — 99A                      2nd — 99B  
 Bottom — 99C

**FIBERGLASS OUTRIGGER KITS—Fig. 476**

Consists of 1 pair Fig. 460 No. 15 Poles, 2 Fig. 469 Clips and Fig. 468 Guides.

SOLD TO TRADE IN LOTS OF 3 KITS ONLY.



Fig. 469



**IMPROVED**  
**OUTRIGGER TROLLING PIN OR CLIP—Fig. 469**

High Impact Black Plastic — Stainless Steel Eyes and Spring — All Salt Water Resistant

Dimensions Inches	Standard Package	Weight Ounces
2¼ x 1-3/8	10	1½

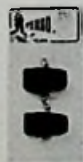
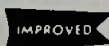

Fig. 469-S.P.

**SKIN PACK—Fig. 469-S.P.**

1 Pair per Card  
 6 Cards per Box  
 Weight per Box 3 Pounds.

SOLD TO TRADE IN FULL BOX ONLY.

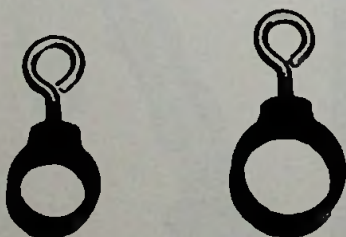

Fig. 468

**IMPROVED**  
**OUTRIGGER POLE LINE GUIDES—Fig. 468**  
 18-8 Stainless Steel Eye for Durability — Black Plastic Body Ultra-Violet Stabilized for Longer Life

No.	I.D. Ring Inches	I.D. Guide Inches	Weight Ounces
1	9/16	3/8	¼
2	5/8	3/8	¼
3	¾	3/8	¼
4	1	3/8	¼
5	1-3/16	3/8	½
6	1½	3/8	½

Standard Package, 6 Pieces.

## OUTRIGGER POLES

FIG. 1098

ANODIZED ALUMINUM

4 FOOT SECTIONS

Easily assembled to length desired. Joints are friction fitted and threaded.

Outriggers for rough water and large game fish should be stiff and strong enough to do the job required. These poles will meet that need.

The Guides are plastic and the base of the pole is sleeved with plastic to insulate against corrosion.

No.	"A" Length Assembled Feet	"B" Diameter Base Inches	"C" Quantity Sections	"D" Quantity Guides	Weight Per Pair Pounds
11	11½	1.125	3	2	4½
15	15	1.125	4	2	6
16	15	1.500	4	2	9
18	18½	1.500	5	3	14
19	18½	1.900	5	3	14½
22	22	1.900	6	3	20
25	25	1.900	7	3	27½

FOR ½ PAIR, SPECIFY FIG. 1098—99A AND SIZE.

### SPARE SECTIONS

Size No.	Section	Size No.	Section
11-A	TOP	19-B	TOP
11-B	MIDDLE	19-C	SECOND
11-C	BOTTOM	19-D	THIRD
15-A	TOP	19-E	FOURTH
15-B	SECOND	19-F	BOTTOM
15-C	THIRD	22-B	TOP
15-D	BOTTOM	22-C	SECOND
16-B	TOP	22-D	THIRD
16-C	SECOND	22-E	FOURTH
16-D	THIRD	22-F	FIFTH
16-E	BOTTOM	22-G	BOTTOM
18-B	TOP	25-B	TOP
18-C	SECOND	25-C	SECOND
18-D	THIRD	25-D	THIRD
18-E	FOURTH	25-E	FOURTH
18-F	BOTTOM	25-F	FIFTH
		25-G	SIXTH
		25-H	BOTTOM

## SPREADERS

FIGS. 1114 & 1115

When extra strength and stiffness is required, spreaders are the answer.

Supplied in packaged kits consisting of spreaders, stainless steel cable, eye bands and turnbuckles.

Fig. 1114 No. 18 Single, for Fig. 1098 Nos. 18 and 19 Poles

Fig. 1114 No. 22 Single, for Fig. 1098 No. 22 Poles

Fig. 1114 No. 25 Single, for Fig. 1098 No. 25 Poles

Fig. 1115 No. 22 Double, for Fig. 1098 No. 22 Poles

Fig. 1115 No. 25 Double, for Fig. 1098 No. 25 Poles



Fig. 1114  
SINGLE



Fig. 1115  
DOUBLE

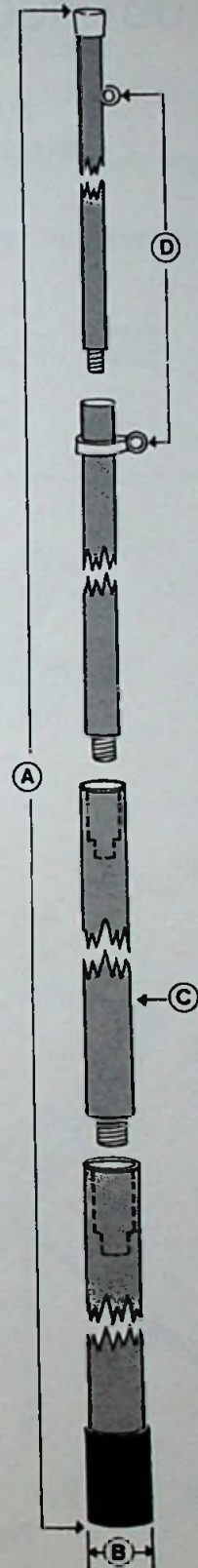
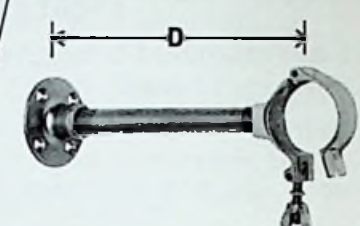
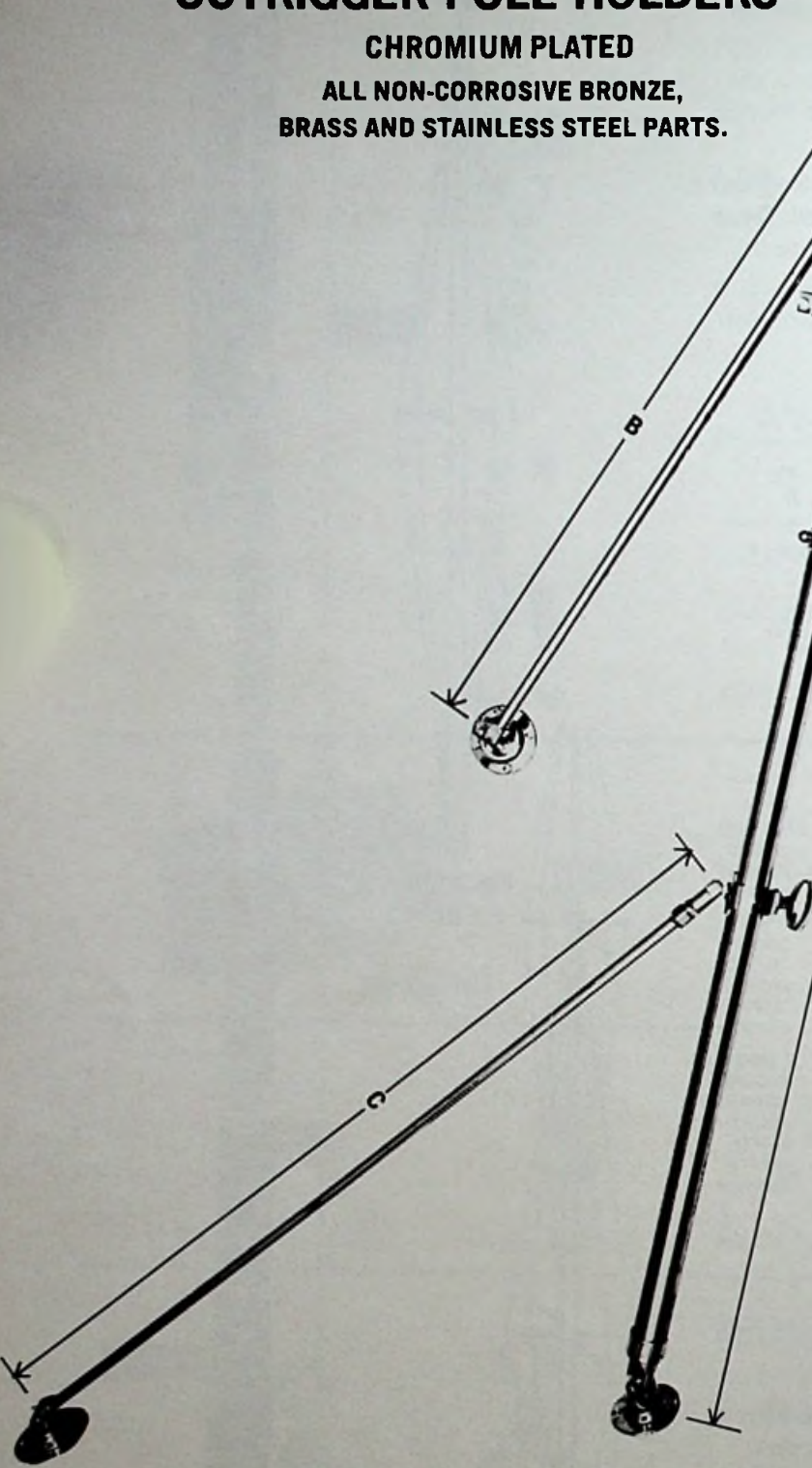

Fig. 1098

**"GAMEFISHER"  
OUTRIGGER POLE HOLDERS**

**CHROMIUM PLATED  
ALL NON-CORROSIVE BRONZE,  
BRASS AND STAINLESS STEEL PARTS.**



If Desired Complete with Special Side Bracket For Fly-Bridge Mounting. Specify Fig. 425

DESIGNED AND RECOMMENDED FOR USE WITH OUR HEAVY DUTY OUTRIGGER POLES FIG. 1098 SIZES NOS. 19, 22 AND 25.

ALL JOINTS ARE SWIVEL TYPE FOR EASE OF INSTALLATION AND SETTING AT DESIRED ANGLE.

A STOP COLLAR IS INCLUDED FOR PRE-SETTING PREFERRED FISHING ANGLE, COLLAR HAS INTEGRAL EYE FOR LIFTING LINE.

UPPER HOLDING BRACKET IS HINGED FOR QUICK RELEASE OF MAIN TUBE.

STURDY HOOKS ARE ALSO INCLUDED FOR SUPPORTING OUTRIGGER IN DOWN POSITION.

MAIN TUBE IS 2 IN. O.D., 1.900 IN. I.D.

No.	"A" Main Tube Feet	"B" Inches	"C" Inches	O.D. Flanges Inches	Weight Per Pair Pounds
4	4	27 $\frac{1}{4}$	41 $\frac{3}{8}$	4	20
6	6	38 $\frac{3}{8}$	50 $\frac{3}{8}$	4	27
8	8	50 $\frac{3}{8}$	74 $\frac{1}{2}$	4	34

"D"—ADJUSTABLE FROM 8 $\frac{3}{4}$ " TO 9 $\frac{1}{2}$ "  
 SPARE HOLDING BRACKETS, SPECIFY FIG. 408  
 SPARE STOP COLLARS, SPECIFY FIG. 409  
 SPARE LAY DOWN HOOKS, SPECIFY FIG 410 NO. 2  
 SPARE SPECIAL SIDE BRACKETS ONLY FOR FLY-BRIDGE MOUNTING, SPECIFY FIG. 426

Fig. 400

## OUTRIGGER POLE HOLDERS

### CHROMIUM PLATED

#### STAINLESS STEEL MAIN TUBE — BRASS YOKE TUBING — CAST BRONZE FITTINGS

THE SLIDING CLAMP WITH LARGE HAND GRIP PROVIDES READY ADJUSTMENT FOR ALL PRACTICAL UP AND DOWN POSITIONS.

TO RELEASE THE POLE HOLDER TO A DOWN AND AFT POSITION A STAINLESS STEEL DRIFT PIN IS PROVIDED IN THE SLIDING CLAMP.

MOUNTING YOKES MAY BE INSTALLED IN AN INVERTED POSITION RATHER THAN THAT SHOWN TO ACCOMMODATE THE VARIATIONS SUCH AN INSTALLATION MIGHT ENTAIL.

No.	Fig. 445 Per Pair	Fig. 470 Per Pair	"A" Inches	"B" Inches	O. D. Main Tube Inches	I. D. Main Tube Inches	Weight Per Pair Pounds
1			20	11 $\frac{3}{4}$	1 $\frac{5}{8}$	1.500	22
2			20	11 $\frac{3}{4}$	2	1.900	24
3			35	24	2	1.900	33

#### SAILFISH — Fig. 445

Has Swinging (Non-Swivel) Rectangular Mounting base.

Nos. 1 and 2 have clamp on one Mounting Bracket to hold Outrigger in vertical position.

No. 3 has Hinged Holding Bracket as supplied with Fig. 400. Also Stop Collar.

All sizes have Folding Lay-Down Hook.

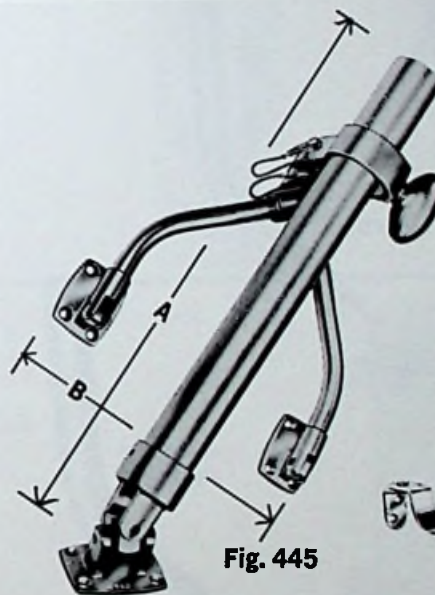

Fig. 445

#### MARLIN — Fig. 470

Has Extra Heavy Swivel Mounting Base which enables the Holder to be mounted on a horizontal deck or a vertical surface such as Cabin Side, Bridge, etc.

Nos. 1 and 2 have clamp on one Mounting Bracket to hold Outrigger in vertical position.

No. 3 has Hinged Holding Bracket as supplied with Fig. 400.

All sizes have Stop Collar and Folding Lay-Down Hook.



Fig. 470

#### SPARE PARTS

Spare Lay Down Hooks, Specify Fig. 410 and Size No.

Spare Stop Collars, Specify Fig. 415 and Size No.

Spare Hinged Holding Brackets, Specify Fig. 408.

SIZE NO. 1 WILL FIT OUTRIGGER POLES FIG. 1098 NOS. 16 and 18.

SIZE NO. 2 WILL FIT OUTRIGGER POLES FIG. 1098 NO. 19.

SIZE NO. 3 WILL FIT OUTRIGGER POLES FIG. 1098 NOS. 19, 22, 25.

## OUTRIGGER POLE HOLDERS

### SIDE OR DECK MOUNT TYPE

Requires very little mounting space — Tubes remove for uncluttered decks.  
Lift Tube and turn for 3 positions — Vertical, fishing, and lowered for bridges.

Tubes are Universal — May Be Used on Either Side

Supplied in Pairs. A Pair consists of 2 Plates and 2 Tubes.



Fig. 444

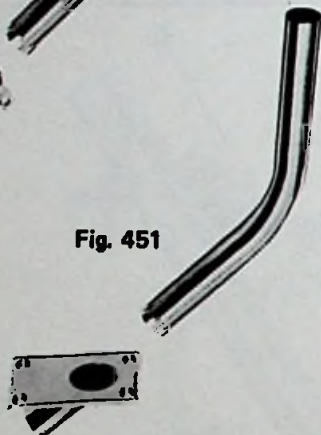

Fig. 451



Fig. 1314

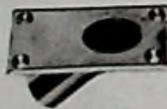

Fig. 1314-SP

IMPROVED



### SIDE MOUNT—Fig. 444

BRONZE, CHROMIUM PLATED BRACKETS  
POLISHED STAINLESS STEEL TUBES

No.	Outside Diameter Tube Inches	Inside Diameter Tube Inches	Dimensions Bracket Inches	Weight Per Pair Pounds
1	1¼	1.125	4½ x 3	2¾
2	1½	1.500	6½ x 4	7

SPARE BRACKETS — SPECIFY FIG 478 AND SIZE NO.  
SPARE TUBES — SPECIFY FIG. 479 AND SIZE NO.

### DECK MOUNT—Fig. 451

BRONZE, CHROMIUM PLATED PLATES  
POLISHED STAINLESS STEEL TUBES

No.	Outside Diameter Tube Inches	Inside Diameter Tube Inches	Dimensions Plate Inches	Weight Per Pair Pounds
1	1¼	1.125	5 x 2½	4½
2	1½	1.500	6 x 3½	12

SPARE PLATES — SPECIFY FIG. 474 AND SIZE NO.  
SPARE TUBES — SPECIFY FIG. 479 AND SIZE NO.

### DECK MOUNT—Fig. 1314

CHROMIUM PLATED PLATES  
STAINLESS STEEL TUBES

For Outrigger Poles, Fig. 460 No. 15

No.	Outside Diameter Tube Inches	Inside Diameter Tube Inches	Dimensions Plate Inches	Weight Per Pair Pounds
1	1¼	1.125	5 x 2½	2¾

SPARE PLATES — SPECIFY FIG. 1320

SPARE TUBES — SPECIFY FIG. 1321

NOTE: NOT DESIGNED FOR USE WITH ALUMINUM POLES,  
i.e. Fig. 1098

### SKIN PACK—Fig. 1314-S.P.

ONE PAIR PER CARD,  
FOUR CARDS PER BOX,  
WEIGHT PER BOX, 10 POUNDS  
SOLD TO TRADE IN FULL BOX ONLY

SIZE NO. 1 WILL FIT OUTRIGGER POLES FIGS. 460 NO. 15 AND 1098 NOS. 11 AND 15.

SIZE NO. 2 WILL FIT OUTRIGGER POLES FIG. 1098 NOS. 16 AND 18.



## CLAMP-ON FISHING ROD HOLDER — Fig. 1118

### CHROMIUM PLATED

Clamp-On feature eliminates drilling rail — simplifies removal or relocation — mounts on vertical or horizontal rails.

Most fishermen will agree that there is no such thing as "too many rod holders" — Here is one for mounting on bow, cockpit or flybridge rails and it's adjustable to any practical angle.

The holder is brass tubing, 2 inches outside diameter, 9 inches long.

The bracket is pressure cast silicon bronze, adjustable for rails 3/4 to 1 inch diameter.

Supplied complete with a full length inner liner which saves wear and tear on the rod. Its inside diameter is 1 3/4 inches. Packed one per box, weight 2 pounds.

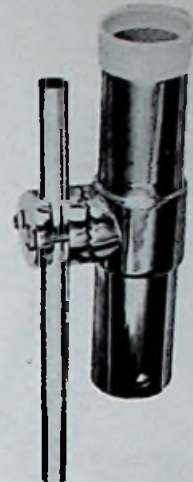

Fig. 1118

## SKIN PACK — Fig. 1118-SP

One Holder Per Card,  
Three Cards Per Box,  
Weight Per Box 6 Pounds

Sold to trade in full box only.



Fig. 1118-SP

## HEAVY DUTY

### FISHING ROD HOLDER — Fig. 404

#### CHROMIUM PLATED — WITH SOFT WHITE VINYL LINER

The holder is heavy gauge brass tubing.

The side mounting brackets are cast bronze.

The improved feature is a full length inner liner of soft vinyl which prevents scarring the rod.

No.	Inside Diameter Liner Inches	Outside Diameter Tube Inches	Length Inches	Width Bracket Inches	Weight Pounds
1	1 3/4	2	9	4-3/16	1 1/2
2	2	2 1/4	11	4-3/4	2 1/2



Fig. 404

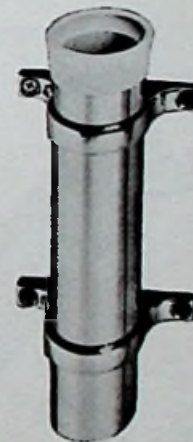

Spare Brackets, Specify Fig. 404-99A and Size

## FISHING ROD HOLDERS—Fig. 449

### Heavy Brass Tubing — Manganese Bronze Castings Chromium Plated — With Soft White Vinyl Liner

The improvement is the addition of Fig. 482 soft vinyl inner liner.

Adaptable to any desired part of the boat, this holder is easily removed when not in use, leaving no projecting hardware.

Inside Diameter Liner Inches	Outside Diameter Tube Inches	Dimensions Mounting Bracket Inches	Weight Complete Pounds
1 3/4	2	4 x 3 3/4	2 1/4

Spare Holders, Specify Fig. 449-99A  
Spare Brackets, Specify Fig. 449-99B

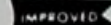

CAN BE  
MOUNTED ON  
GUNWALE OR DECK



Fig. 449

### FISHING ROD HOLDER — FIG. 1205



IMPROVED

Fig. 1205

CHROMIUM PLATED FLANGE  
ANODIZED ALUMINUM TUBE  
SOFT WHITE VINYL LINER

The improved feature is the addition of a soft white vinyl inner liner which fully lines the tubing.

Inside Diameter Liner Inches	Outside Diameter Tube Inches	Length Under Flange Inches	Dimensions Flange Inches	Weight Pounds
1½	2	8	4¼ x 3½	1

Supplied with Closed Bottom — Specify Fig. 1206



Fig. 1205-S.P.

### SKIN PACK — Fig. 1205-S.P.

One holder per card,  
Four cards per box,  
Weight per box, 4½ pounds

Sold to Trade in Full Box Only.



IMPROVED

Fig. 448

### BRONZE FISHING ROD HOLDERS — Fig. 448

Chromium Plated Flange — Brass Tube  
White Soft Vinyl Liner

Improved by the addition of a full length inner liner made of soft white vinyl.

No.	Inside Diameter Liner Inches	Outside Diameter Tube Inches	Length Under Flange Inches	Dimensions Flange Inches	Weight Pounds
1	1½	2	8	4¼ x 3½	1¼
2	1¾	2¼	12	4¾ x 4	2

No. 1 Supplied with Closed Bottom, Specify Fig. 458.

### ALL STAINLESS STEEL FISHING ROD HOLDERS — Fig. 452

18-8 SS — Polished

Soft White Vinyl Liner — Heavy Under Flange Gasket

Improved with a Fig. 482 inner liner for extra protection.

IMPROVED

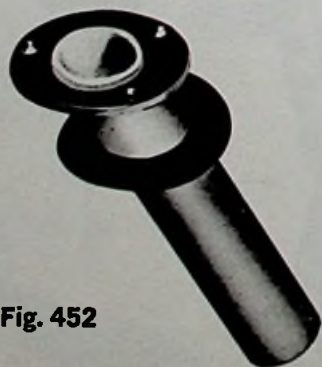

Fig. 452

Inside Diameter Liner Inches	Outside Diameter Tube Inches	Length Under Flange Inches	Dimensions Flange Inches	Weight Pounds
1½	2	8¼	4¾ x 3¾	7/8

Supplied with Closed Bottom, Specify Fig. 459.

Spare Gaskets, Specify Fig. 452—99A.

## FISHING ROD HOLDERS—Fig. 1100

All Brass — Chromium Plated — With Soft White Vinyl Liner

Improvement is an addition of a full length inner liner.

Inside Diameter Liner Inches	Outside Diameter Tube Inches	Length Overall Inches	Width Bracket Inches	Weight Oz.
1¾	2	9	3	16



Fig. 1100

Spare Brackets, Specify Fig. 1107

### IMPROVED

## FISHING ROD HOLDERS — Fig. 1104

Black Plastic — With Chromium Plated Brass Brackets

Length Overall Inches	Inside Diameter Inches	Outside Diameter Inches	Width Bracket Inches	Weight Ounces
9	1¾	2	3¼	8



Fig. 1104

Spare Brackets, Specify Fig. 1107

## SKIN PACK — Fig. 1104-S.P.

One Holder per Card

Six Cards per Box

Weight per Box 4 Pounds

Sold to Trade in Full Box Only.



Fig. 1104-S.P.

## ADJUSTABLE FISHING ROD HOLDERS — Fig. 475

Plain or Chromium Plated

Heavy Brass Tubing — Manganese Bronze Castings

Improvement is our Fig. 483 full length inner liner.

May be adjusted quickly to any desired angle or position vertically or horizontally. Locked by large thumb bolt illustrated.

Inside Diameter Liner Inches	Outside Diameter Tube Inches	Length Tube Inches	Dimensions Base Inches	Weight Pounds
1¾	2	9½	3¾ x 2¼	3¾

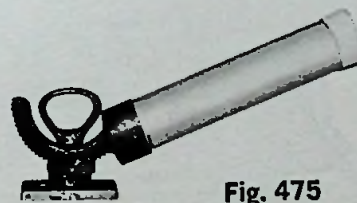
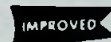

Fig. 475

Spare Tube with Quadrant, Specify Fig. 475—99A

Spare Adjusting Saddle for Quadrant, Specify Fig. 475—99B

Spare Eye Bolts with Washer, Specify Fig. 475—99C

Specify Finish on Spares, Plain or Chrome

## SOFT WHITE VINYL LINERS

### FOR ROD HOLDERS

Improvement is the addition of a full length inner liner for added protection against scarring of rod.

Fig.	Size No.	Inside Diameter Inches	Weight Ounces
482	1	1½	1
482	2	1¾	1
483	1	1¾	½
483	2	2	1

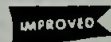

Fig. 482

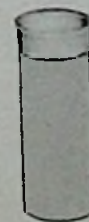

Fig. 483

Fig. 482 No. 1 Fits Fig. 448 No. 1, Figs. 452 and 1205

Fig. 482 No. 2 Fits Fig. 448 No. 2

Fig. 483 No. 1 Fits Fig. 404 No. 1 Figs. 449, 475, 1100 and 1118

Fig. 483 No. 2 Fits Fig. 404 No. 2

FIG. 468  
LINE GUIDES

Figs. 460 or 1098 Poles

FIG. 469  
CLIP-PIN  
FIG. 565  
PULLEY  
OR  
FIG. 417  
1" RING

FIGS. 451  
or 1314  
POLE HOLDER

FIG. 544  
3" CLEAT

FIG. 448, 452  
OR 1205  
ROD HOLDERS

CRUISING POSITION

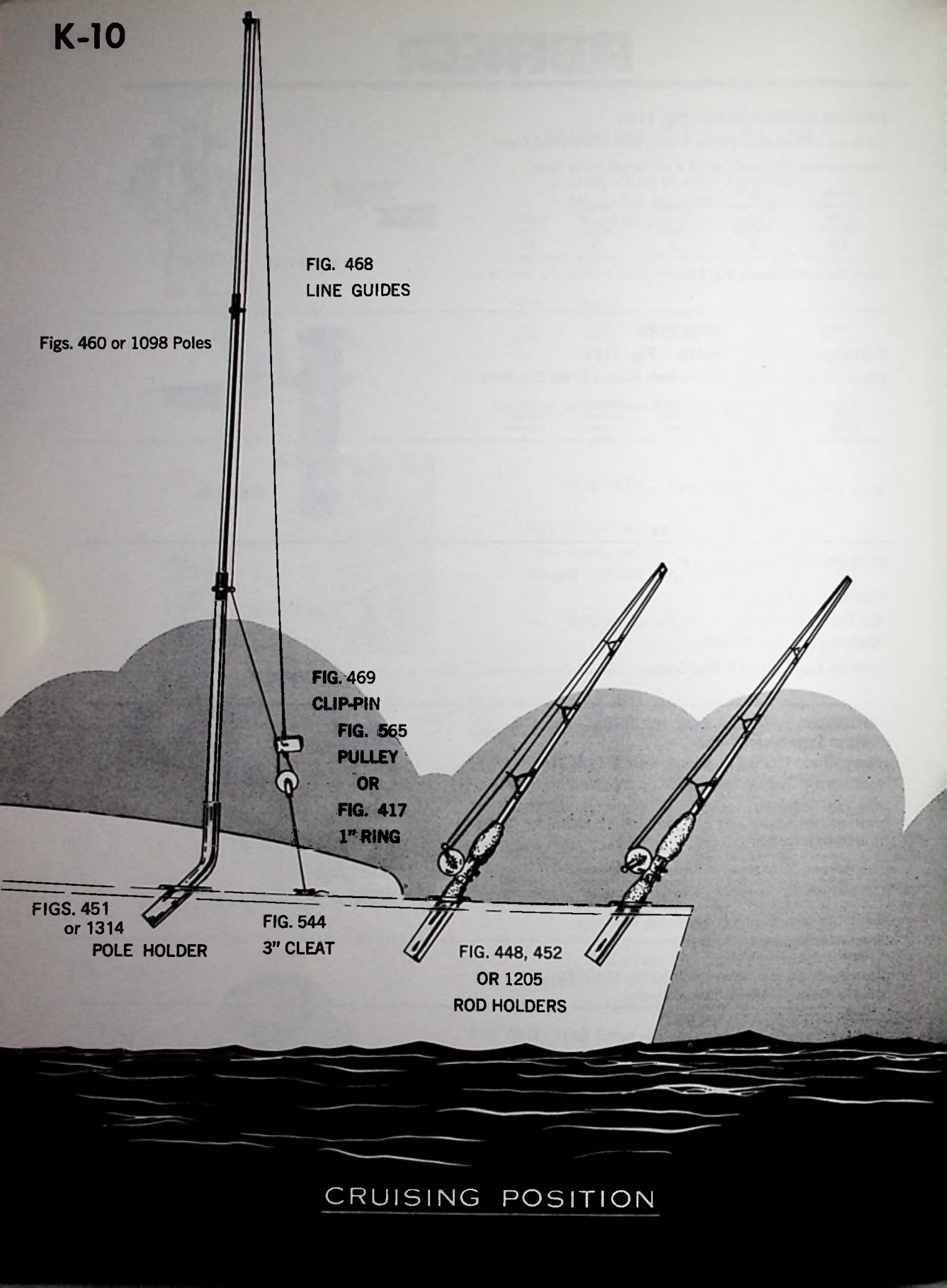



OUTRIGGERS  
EXTENDED  
TO 60° —  
TROLLING

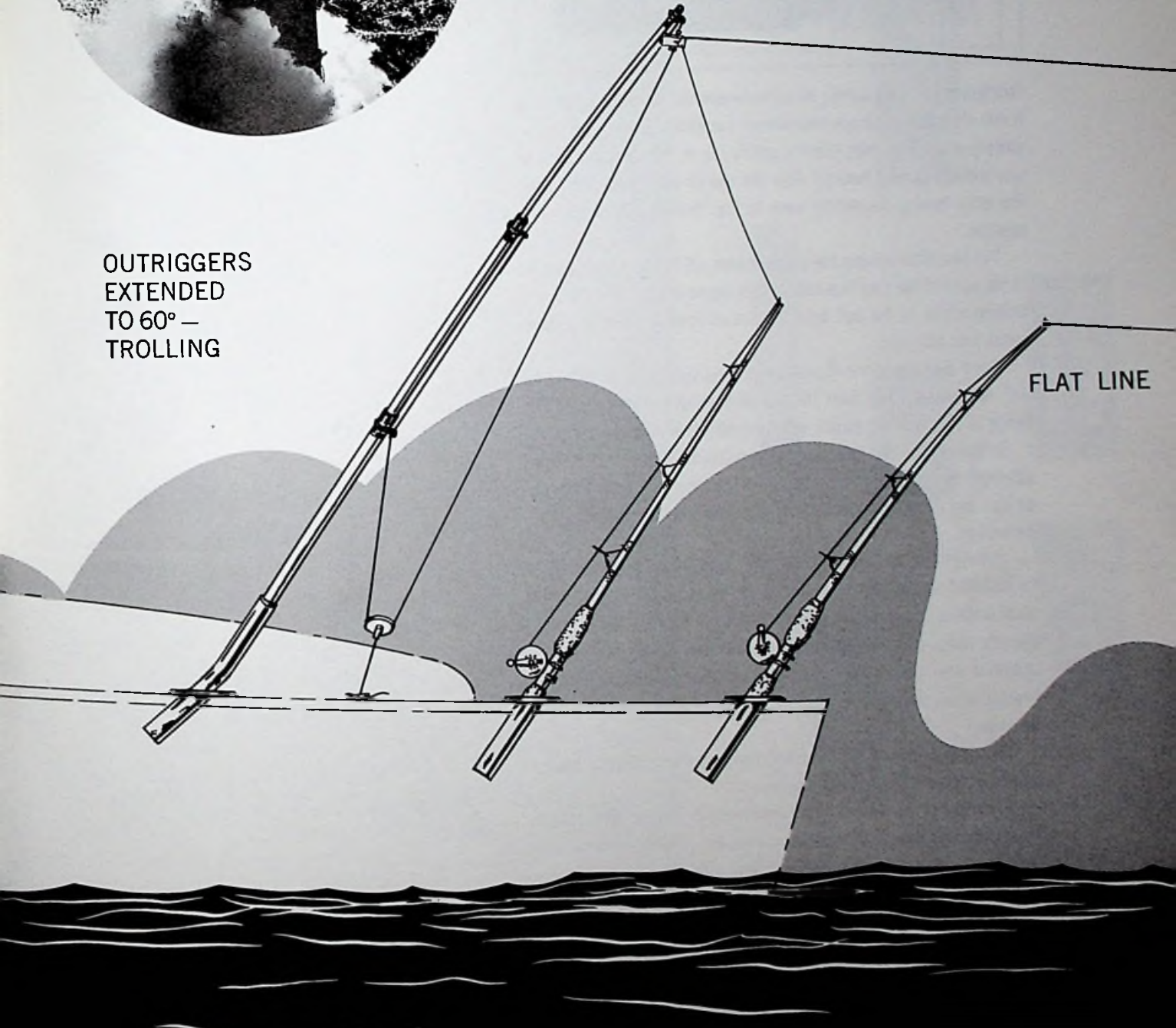

FLAT LINE

TROLLING POSITION



## THE USAGE OF OUTRIGGERS

by "Hank" Gartner

Outriggers for sport fishing boats were devised some time ago when it was observed that many members of the billfish family would strike sharply at a trolled bait, literally destroying it, then proceed on their way without getting hooked. With the use of outriggers, the fishing line after leaving the rod tip leads to the "trolling pin" in its raised position.

The line after leaving the pin proceeds aft to the proper position in the wake of the boat that the captain deems best to give the proper trolling action to the bait being trolled whether it be mullet, balao, squid, line bait, etc.

Using outriggers, the fish after striking vigorously at the trolled bait releases the line from the pin permitting a slack loop of line, which in turn lets the struck bait lie motionless in the water.

In theory, the fish believing his prey stunned, grabs the bait and attempts to make off with it. When the fish runs out of the slack loop of line and is brought up by that taut line, theoretically he should be hooked.

Outriggers with their "trolling pin," lead lines and guides should be installed on the boat as indicated in the accompanying diagrams. Modifications may be necessary to accommodate each individual owner's boat. It is recommended to have the top guide (Perko Fig. #468) a few inches down from the extreme tip of the pole, this precludes the possibility of the pin wrapping around and tangling on the pole.

Should the owner wish to install dual pins they should be approximately 3' apart on the same lead line.

Outrigger poles should be parallel when in their vertical position. To accomplish this, it may be necessary to build up the deck under the bases of the outrigger pole holders with small teak wedges or fiberglass putty.

The small cleats (Perko Fig. #544-3") should be secured aft of the outrigger base, thus keeping the "trolling pin" line clear of the outrigger pole and the return line.

# PERKO<sup>INC.</sup>

16490 NORTHWEST 13TH AVENUE • P.O. BOX 64000-D • MIAMI, FLORIDA 33164

PRINTED IN U.S.A.

# PERKO®

## SKIN PACK



MANUFACTURED BY PERKO, INC., 16490 N.W. 13TH AVE., P.O. BOX 64000-D, MIAMI, FLORIDA 33164

FOR COMPLETE LINE SEE CATALOG NO. 230

## NEW



Fig. 1510-SP

CERTIFIED



Fig. 1310 SP

CERTIFIED



Fig. 1218 SP

CERTIFIED



Fig. 1146 SP

CERTIFIED



Fig. 972 SP

CERTIFIED

"CHROMALEX" III<sup>®</sup> COMBINATION BOW LIGHT—Fig. 1510-SP

Die Cast Zinc Alloy — Chromium Plated — Red and Green Fresnel Lenses  
Black Plastic Base — Molded Teak Plastic Insert — Non Corrosive  
Double Contact Electric Socket with 12 Volt, No. 1004 Lamp.

Height Inches	Size Base	Screw No.
1 7/8	4 x 3-1/8	8

One Light Per Card.

Six Cards Per Box.

Weight Per Box, 2½ Pounds.

"CHROMALEX"<sup>®</sup> COMBINATION BOW LIGHT—Fig. 1310-SP

Die Cast Zinc Alloy — Chromium Plated — Black Plastic Base  
— Red and Green Fresnel Lenses.

Non Corrosive Double Contact Electric Socket with 12 Volt,  
No. 1004 Lamp.

Height Inches	Size Base Inches
1-¾	4x3-½

One Light Per Card.

Six Cards Per Box.

Weight Per Box, 2½ Pounds.



## "RANGER" COMBINATION BOW LIGHT — Fig. 1218-SP

Die Cast Zinc Alloy — Chromium Plated — Red and Green  
Fresnel Lenses — Double Contact Electric Socket — With 12  
Volt, No. 1004 Lamp.

Height Inches	Size Base Inches	Height Lens Inches	Staff Socket Inches
3-½	6-¼ x 3-¾	2-½	¾

One Light Per Card.

Three Cards Per Box.

Weight Per Box, 4 Pounds.



## "LITTLE JOE" COMBINATION BOW LIGHT — Fig. 1146-SP

Die Cast Zinc Alloy — Chromium Plated — With 12 Volt,  
No. 1416 Lamp — Miniature Bayonet Socket.

Height Inches	Base Inches	Height Lens Inches	Staff Socket Inches
2-¼	4½ x 2-¾	1-¾	½

One Light Per Card.

Three Cards Per Box.

Weight Per Box, 1¾ Pounds.

"CHROMALEX"<sup>®</sup> COMBINATION BOW LIGHT — Fig. 972-SP

Brass — Chromium Plated — Black Plastic Base.

Red and Green Lenses —

Miniature Bayonet Electric Socket — With 12 Volt, No. 1416 Lamp.

Height of Light Inches	Diameter Base Inches	Diameter Neck Inches	Length Neck Inches
1-¾	2-¾	¾	½

One Light Per Card.

Four Cards Per Box.

Weight Per Box, 1 Pound.

Sold To Trade In Full Box Only



**"CHROMALEX"<sup>®</sup> INTERNATIONAL NAVIGATION LIGHTS  
BRASS – CHROMIUM PLATED BLACK PLASTIC BASE  
WITH STAINLESS STEEL SELF TAPPING SCREWS FOR MOUNTING**

**SIDE LIGHTS – Fig. 955-SP**

**10 Points – 112½ Degrees – 1 Mile Visibility.**

Certified with No. 90, 12 Volt, 6 C.P. Lamp Supplied with Lights.

Non Corrosive Double Contact Socket.

Red and Green High Intensity Fresnel Lenses.

Length Inches	Width Inches	Depth Inches
4-¼	2-¾	1-¾

One Pair Per Card.

Four Cards Per Box.

Weight Per Box 2 Pounds.

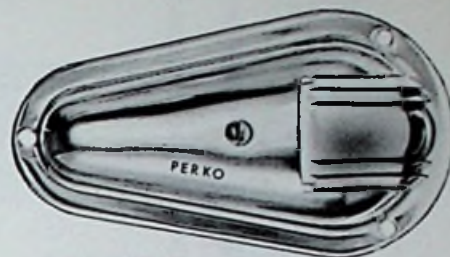

Fig. 955-SP

**CERTIFIED**

**BOW OR MASTHEAD LIGHT – Fig. 964-SP**

**20 Points – 225 Degrees – Clear Lens.**

**3 Mile Visibility.**

Certified With No. 1416, 12 Volt, 8 C.P. Lamp Supplied With Light — Miniature Bayonet Type Socket.

Height of Light Inches	Diameter Base Inches	Diameter Neck Inches	Length Neck Inches
1-5/8	2-3/8	3/4	1/2

One Light Per Card.

Four Cards Per Box.

Weight Per Box 1 Pound.



Fig. 964-SP

**CERTIFIED**

**TRANSOM STERN LIGHT – Fig. 945-SP**

**12 Points – 135 Degrees – Clear Lens.**

**2 Mile Visibility.**

Certified With No. 1416, 12 Volt, 8 C.P. Lamp Supplied With Light. Miniature Bayonet Type Socket.

Height of Light Inches	Diameter Base Inches	Diameter Neck Inches	Length Neck Inches
1-5/8	2-3/8	3/4	1/2

One Light Per Card.

Four Cards Per Box.

Weight Per Box 1 Pound.



Fig. 945-SP

**CERTIFIED**

**STERN LIGHT – Fig. 965-SP**

**12 Points – 135 Degrees – Clear Lens.**

**2 Mile Visibility.**

Certified With No. 1416, 12 Volt, 8 C.P. Lamp Supplied With Light — Miniature Bayonet Type Socket.

Height of Light Inches	Diameter Base Inches	Diameter Neck Inches	Length Neck Inches
1-5/8	2-3/8	3/4	1/2

One Light Per Card.

Four Cards Per Box.

Weight Per Box 1 Pound.



Fig. 965-SP

**CERTIFIED**



Fig. 1530 SP

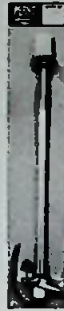

Fig. 1511 SP



## NEW "CHROMALEX"<sup>®</sup> III

### REMOVABLE STERN POLE LIGHTS—Fig. 1530-SP

Polished Chromium Plated — Die Cast Zinc Alloy Globe Holder and Base — Molded Teak Plastic Insert in Base — Frosted Globe — Improved Tightening Device — Non Corrosive Electric Socket — Anodized Aluminum Pole.

Base Length 3-3/4" — Width 1-1/2" — Maximum Height of Light 24 Inches — Supplied with 12 Volt Lamp, No. 1004, 15 C.P. 32 Points.

Has Two Prong Electric Plug in bottom of Pole for Electric Socket in Base.

One Light Per Card.  
Five Cards Per Box.  
Weight Per Box, 5 Pounds.



## NEW "CHROMALEX"<sup>®</sup> III

### STERN POLE LIGHTS—Fig. 1511-SP

Polished Chromium Plated — Die Cast Zinc Alloy Globe Holder and Base — Molded Teak Plastic Insert in Base — Frosted Globe — Improved Tightening Device — Delrin Non Corrosive D.C. Socket — Complete with 12 Volt Lamp, No. 1004, 15 C.P. — 32 Points.

Base Dimension 3-3/4" Long, 1-1/2" Wide. Maximum Height of Light, 24 Inches.

One Light Per Card.  
Five Cards Per Box.  
Weight Per Box, 4½ Pounds.



## "CHROMALEX"<sup>®</sup>

### REMOVABLE STERN POLE LIGHTS — Fig. 1330-SP

Polished Chromium Plated — Die Cast Zinc Alloy Globe Holder and Base — High Intensity Fresnel Globe — Non Corrosive Electric Socket With 12 Volt Lamp, No. 90 — Anodized Aluminum Pole. Base Length 3-3/8" — Width 1-5/8". Maximum Height of Light, 24 Inches.

Has Two Prong Electric Plug in bottom of Pole for Electric Socket in Base.  
Pole is instantly removable for stowing away.

One Light Per Card.  
Five Cards Per Box.  
Weight Per Box, 5 Pounds.



## "CHROMALEX"<sup>®</sup> STERN POLE LIGHTS — Fig. 1311-SP

Polished Chromium Plated — Die Cast Zinc Alloy Globe Holder and Base — Clear High Intensity Fresnel Globe — Delrin Non-Corrosive D.C. Socket — Complete With 12 Volt Lamp, No.90.

Base Dimension 3-3/8"x1-5/8". Maximum Height of Light, 24 Inches.

One Light Per Card.  
Five Cards Per Box.  
Weight Per Box, 4½ Pounds.

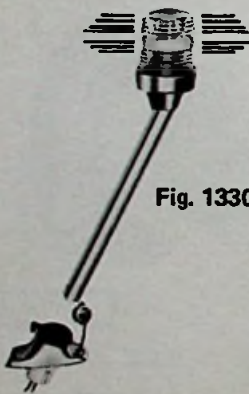

Fig. 1330 SP



Fig. 1311 SP



Sold To Trade In Full Box Only

**BULKHEAD FIXTURE – Fig. 217-SP**  
 Die Cast Zinc Alloy – Chromium Plated.  
 Medium Screw Socket – Turn Switch.

Size Base Inches	Projection Inches
2- $\frac{1}{2}$ x 1- $\frac{3}{4}$	2- $\frac{5}{8}$

One Fixture Per Card.  
 Six Cards Per Box.  
 Weight Per Box, 4 Pounds.



Fig. 217-SP

**DOME LIGHTS – Fig. 300-SP**  
 Die Cast Zinc Alloy – Chromium Plated.  
 Double Contact Socket – Push Switch.

Diameter Glass Inches	Diameter Overall Inches	Depth Overall Inches
4	5- $\frac{3}{8}$	1- $\frac{7}{8}$

One Light Per Card.  
 Three Cards Per Box.  
 Weight Per Box, 2 $\frac{1}{4}$  Pounds.



Fig. 300-SP

**UTILITY LIGHT – Fig. 140-SP**  
 White Nylon – With 12 Volt Lamp.  
 For instruments, charts or general fair illumination.

Size Inches
1- $\frac{3}{8}$ x $\frac{5}{8}$

One Light Per Card.  
 Ten Cards Per Box.  
 Weight Per Box,  $\frac{1}{2}$  Pound.



Fig. 140-SP

**MINIATURE BAYONET BASE LAMP – Fig. 56-SP**  
 CLEAR – No. 4  
 12 VOLT 8 C.P. DIAMETER 18/32 INCHES

Two Lamps Per Card.  
 Twelve Cards Per Box.  
 Weight Per Box,  $\frac{1}{2}$  Pound.



Fig. 56-SP

**CARTRIDGE TYPE BASE LAMP – Fig. 70-SP**  
 CLEAR – No. 1  
 12 VOLT 12 C.P. DIAMETER 9/16 INCHES

Two Lamps Per Card.  
 Twelve Cards Per Box.  
 Weight Per Box,  $\frac{1}{2}$  Pound.

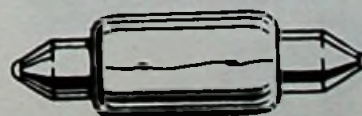

Fig. 70-SP





Fig. 85-SP

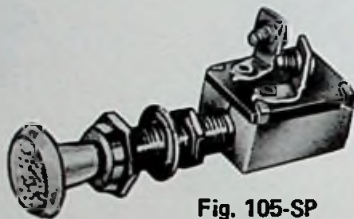

Fig. 105-SP

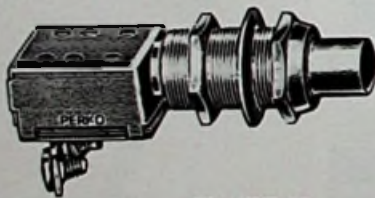

Fig. 255-SP

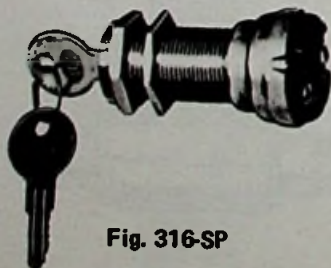
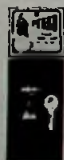
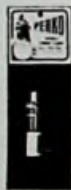

Fig. 316-SP

## IMPROVED SAFETY MAIN SWITCH—Fig. 85-SP

Red Plastic Housing — Vapor Tight — Copper Contacts — Brass Terminals — Stainless Steel Spring — For 2 or more batteries.

Improved Feature Allows Use With Alternators or Generators Since it is a Make-Before-Break Design.

Rated at 210 amperes continuous, 315 amperes intermittent. (6, 12, and 32 volts).

Can be installed flush or offset. Supplied with complete set of 4 offset mounting legs.

Tested and accepted for labeling and listing by the Underwriters Laboratories, Inc.

Diameter Inches	Depth Inches
5	1-3/4

One Switch Per Card.  
Three Cards Per Box.  
Weight Per Box, 4 Pounds.

## PUSH AND PULL SWITCHES — Fig. 105-SP

3/8 Inch Knob — 25 Amp. — Chromium Plated Knob — Brass Housing.

No.	Diam. Neck Inches	For Wood Thickness Inches	Length Overall Inches	Diam. Knob Inches
1	3/8	1	3	3/4

One Switch Per Card.  
Twelve Cards Per Box.  
Weight Per Box, 3 Pounds.

## MOMENTARY STARTER SWITCH OR DASHBOARD HORN BUTTON — Fig. 255-SP

All Brass — Push Button Type — 2 Point, 2 Terminal Spring Action — Chromium Plated Button — 25 Amp.

No.	Diameter Neck Inches	For Wood Thickness Inches
1	5/8	1

One Switch Per Card.  
Six Cards Per Box.  
Weight Per Box, 3 Pounds.

## IGNITION LOCK SWITCH — Fig. 316-SP

Face Plate Chromium Plated — 2 Terminal — 2 Keys — 20 Amp.

No.	Diameter Neck Inches	Length Neck Inches
1	3/4	3/4

One Switch Per Card.  
Six Cards Per Box.  
Weight Per Box, 2 Pounds.

## PUSH TYPE SWITCH – Fig. 703-SP

Non Magnetic – With 6 Inch Wire Leads

Length Neck Inches	Diameter Neck Inches	Between Lock Nuts Inches
3/8	9/8	1/8

One Switch Per Card.  
Six Cards Per Box.  
Weight Per Box, 9 Ounces.



Fig. 703-SP



## FUSED LINE CONNECTOR – Fig. 786-SP

Molded Bakelite – With 20 AMP. Fuse and Wire Leads.

For Standard Glass Fuses 1 1/4 Inches Long.

Length Inches	Diameter Inches
2-1/8	5/8

One Connector Per Card.  
Ten Cards Per Box.  
Weight Per Box, 3/4 Pound.



Fig. 786-SP



## MOLDED LINE CONNECTORS – Fig. 720-SP

Waterproof Bodies – Color Coded Wires.

Polarized for proper mating of circuits. Conductors precision aligned and molded in S.A.E. Type P.V.C. insulation for minimum voltage drop and ease in making and breaking connections.

12 inch long wires on male and female sides.

Poles	Width Inches	Weight Per Box Ounces
2	9/8	6-1/4
3	7/8	9
4	1-1/8	11-1/4

One Connector Per Card.  
Five Cards Per Box.  
Specify Size.

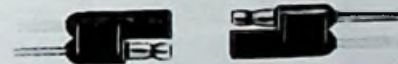

Fig. 720-2

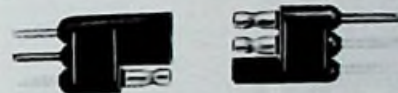

Fig. 720-3



Fig. 720-SP



## WATERTIGHT DECK CONNECTION – Fig. 1190-SP

Die Cast Zinc Alloy with Black Plastic Covers – Double Contact – Chromium Plated.

The covers snap on or off for quick connection.  
The connector is brass, well insulated.

Diameter Inches	Height Inches
1-5/8	1-3/16

One Connection Per Card.  
Five Cards Per Box.  
Weight Per Box, 14 Ounces.

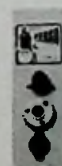

Fig. 1190-SP

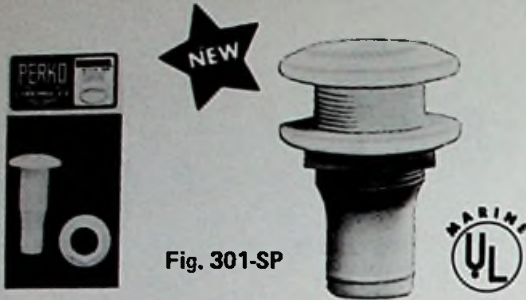

Fig. 301-SP

**PLASTIC THRU-HULL CONNECTIONS—Fig. 301-SP**

Durable Plastic — For Use With Hose

No.	For Hose Inches	Diam. Flange Inches	Cards Per Box	Wt. Per Box Pounds
4	1/2	1-1/2	10	1-1/2
4A	5/8	1-1/2	10	1-1/2
5	3/4	1-7/8	8	1-3/4
6	1	2-1/4	6	2
8	1-1/2	3	6	3

One Connection Per Card.



Fig. 414-SP

**BRASS TRANSOM DRAIN PLUGS — Fig. 414-SP**

No.	Diam. Tube Inches	Length Overall Inches	Length Tube Inches
1	1	2-1/2	2

One Drain Plug Per Card.

Twelve Cards Per Box.

Weight Per Box, 4 Pounds.



Fig. 33-SP



Fig. 34-SP

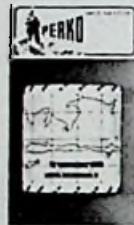

Fig. 36-SP

**MARINE SHIELDS FOR FIXTURES—**

Figs. 33 SP, 34 SP, 36 SP

The latest nautical designs — Suitable for hanging and upright bulb — Width 4-1/2" Height 4-5/8".

One Shield Per Card.

Six Cards Per Box.

Weight Per Box, 2 Pounds.

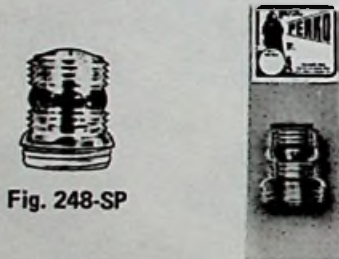

Fig. 248-SP

**HIGH INTENSITY FRESNEL GLOBE — Fig. 248-SP**

Clear Plastic Complete With Gasket

Outside Diam. Inches	Height Inches	Diam. Thread Inches
1-3/4	2-1/2	2

One Globe Per Card.

Ten Cards Per Box.

Weight Per Box, 1 1/2 Pounds.

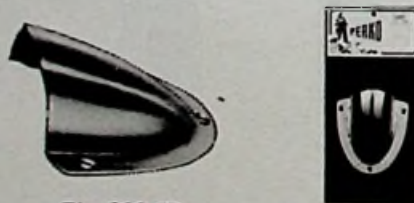

Fig. 339 SP

**CLAM SHELL VENTILATOR — Fig. 339-SP**

Brass — Chromium Plated.

Width Opening Inches	Height Opening Inches	Base Dimensions Inches	For Screw No.
2-1/2	1-5/8	4x3 3/4	6

One Vent Per Card.

Six Cards Per Box.

Weight Per Box, 4 Pounds.



Fig. 315 SP

**MIDGET CLAM SHELL VENTILATOR — Fig. 315-SP**

Brass — Chromium Plated.

No.	Base Dimensions Inches	Height Opening Inches	For Screw No.
2	2x2	9/16	6

One Vent Per Card.

Twelve Cards Per Box.

Weight Per Box, 1 1/2 Pounds.

**NEW**

**"CHROMALEX" III® GAS FILL—Fig. 1513-SP**

Polished Chromium Plated — Die Cast Zinc Alloy Body — Molded Teak Plastic Floating Cap  
Neck has bead for improved neck retention.

Diameter Overall Inches	Length Hose Neck Inches	For Screw No.	For Hose Size
3-1/8	1-5/8	7	1-1/2

One Fill Per Card.  
Six Cards Per Box.  
Weight Per Box, 4 Pounds.



Fig. 1513 SP

**CHROMALEX® GAS FILL — Fig. 1313-SP**

Black Plastic Flange  
Die Cast Zinc Alloy — Chromium Plated  
For Use With 1½" I.D. Hose.  
Neck has bead for improved hose retention.

Diameter Overall Inches	Length Hose Neck Inches	For Screw No.
3-7/8	1-5/8	7

One Fill Per Card.  
Six Cards Per Box.  
Weight Per Box, 3½ Pounds.



Fig. 1313-SP

**"CHROMALEX"® COWL VENTILATOR — Fig. 1312-SP**

Black Plastic Base — Die Cast Zinc Alloy  
Polished Chromium Plated — For 3" Duct.

Mouth Opening Square Inches	Length Overall Inches	Width Overall Inches	Height Overall Inches
7	5-3/4	4-3/8	2-5/8

One Vent Per Card.  
Four Cards Per Box.  
Weight Per Box, 3 Pounds.



Fig. 1312 SP

**NEW**

**"CHROMALEX" III® COWL VENTILATOR—Fig. 1512-SP**

Chromium Plated — Die Cast Zinc Alloy Body  
Molded Teak Plastic Insert — Black Plastic Base

Designed for fast mounting. Has integral air scoop — No hose clamps necessary — Duct threads into collar.

Mouth Opening Square Inches	Length Overall Inches	Width Overall Inches	Height Overall Inches
7	5-3/4	4-3/8	2-5/8

One Vent Per Card.  
Four Cards Per Box.  
Weight Per Box, 3 Pounds.



Fig. 1512 SP



**LOCKER VENTILATORS — Fig. 330-SP**

18-8 Stainless Steel — Polished.

No.	Diameter Inches	For Screw No.
2	3-1/4	6

One Vent Per Card.  
Twelve Cards Per Box.  
Weight Per Box, 1½ Pounds

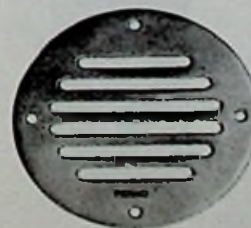

Fig. 330 SP



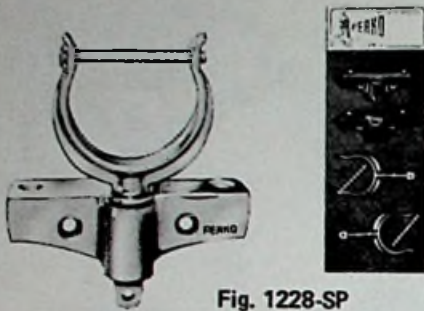

Fig. 1228-SP

### NORTH RIVER ROWLOCKS – Fig. 1228-SP

Die Cast Zinc Alloy – Chromium Plated – With Delrin Bearing in Socket – Between Horns, 1¾ Inches.

One Pair Per Card.  
Six Cards Per Box.  
Weight Per Box, 8½ Pounds.

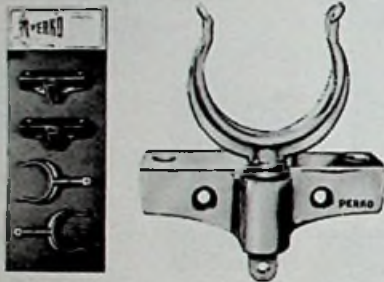

Fig. 1263-SP

### RIBBED SIDE PLATE ROWLOCKS – Fig. 1263-SP

Die Cast Zinc Alloy – Chromium Plated – With Delrin Bearing in Socket – Between Horns, 1¾ Inches.

One Pair Per Card.  
Six Cards Per Box.  
Weight Per Box, 8 Pounds.

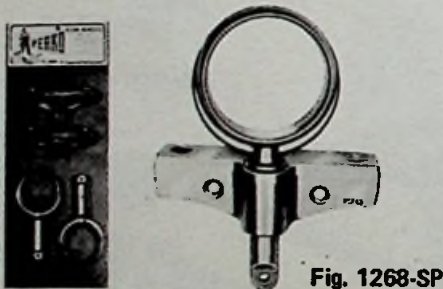

Fig. 1268-SP

### ROUND ROWLOCKS WITH FANCY SOCKET – Fig. 1268-SP

Die Cast Zinc Alloy – Chromium Plated – Delrin Bearing in Socket – Inside Diameter Horns, 2 Inches.

One Pair Per Card.  
Six Cards Per Box.  
Weight Per Box, 8¾ Pounds.



Fig. 1267-SP

### ROUND ROWLOCKS HORNS – Fig. 1267-SP

Die Cast Zinc Alloy  
Inside Diameter 2 Inches  
Diameter Shank ½ Inch.

**NATURAL FINISH**  
One Pair Per Card.  
Six Cards Per Box.

**CHROMIUM PLATED**  
One Pair Per Card.  
Six Cards Per Box.

Weight Per Box, 4½ Pounds.



**NORTH RIVER ROWLOCK HORNS – Fig. 1227-SP**

Die Cast Zinc Alloy – Between Horns 1¾ Inches.  
Diameter Shank ½ Inch.

**NATURAL FINISH**

One Pair Per Card.  
Six Cards Per Box.  
Weight Per Box, 4 Pounds.

**CHROMIUM PLATED**

One Pair Per Card.  
Six Cards Per Box.  
Weight Per Box, 4 Pounds.



**Fig. 1227 SP**

---

**RIBBED ROWLOCK HORNS – Fig. 1262-SP**

Die Cast Zinc Alloy – Between Horns 1¾ Inches.  
Diameter Shank ½ Inch.

**NATURAL FINISH**

One Pair Per Card.  
Six Cards Per Box.  
Weight Per Box, 4 Pounds

**CHROMIUM PLATED**

One Pair Per Card.  
Six Cards Per Box.  
Weight Per Box, 4 Pounds.



**Fig. 1262 SP**



---

**TRANSOM PLATES – Fig. 1224-SP**

Die Cast Zinc Alloy – Chromium Plated.  
Length Overall 3½ Inches.  
Inside Diameter 1-7/8 Inches.

One Pair Per Card.  
Twelve Cards Per Box.  
Weight Per Box, 3¼ Pounds.



**Fig. 1224 SP**



Fig. 159-SP

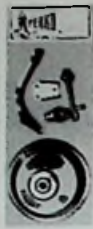

**BRASS FOG BELLS – CHROMIUM PLATED – Fig. 159-SP**

With Removable Arm and Wall Plate.  
Clapper has short arm for Lanyard.

Diameter Inches	Height Overall Inches
6	4

One Bell Per Card.  
Two Cards Per Box.  
Weight Per Box, 2¾ Pounds.



**TRIPLEX MOTOR BOAT WHISTLE – Fig. 167-SP**

Plastic

Length Overall Inches	Width Overall Inches
6	1-¾

One Whistle Per Card.  
Twelve Cards Per Box.  
Weight Per Box, 1½ Pounds.



**NEW**

**FOG HORN—Fig. 162-SP**

**ALUMINUM – DURABLE WHITE BAKED ENAMEL FINISH  
NYLON MOUTHPIECE**

Lightweight Fog Horn that is attractive and practical –  
Length 12-1/2 Inches.

One Horn Per Card.  
Six Cards Per Box.  
Weight Per Box 2½ Pounds.



**BOAT COVER SOCKETS – Fig. 578-SP**

Die Cast Zinc Alloy – Chromium Plated.

Length Overall Inches	Size Opening Inches	Width Overall Inches
3-¼	1-¾x7/16	5/8

One Pair Per Card.  
Twelve Cards Per Box.  
Weight Per Box, 3 Pounds.



**DECK PLATE KEY – Fig. 827-SP**

**ALUMINUM GOLD ANODIZED**

Will fit various sizes of deck plates up to 3 inches.

Length Overall Inches	Diameter Metal Inches
5-¾	3/16

One Key Per Card.  
Six Cards Per Box.  
Weight Per Box, 1½ Pounds.

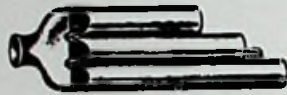

Fig. 167-SP

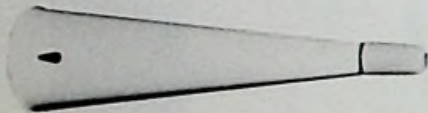

Fig. 162-SP

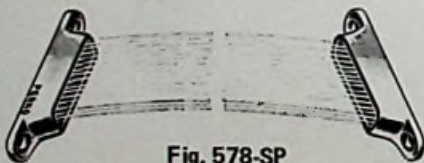

Fig. 578-SP

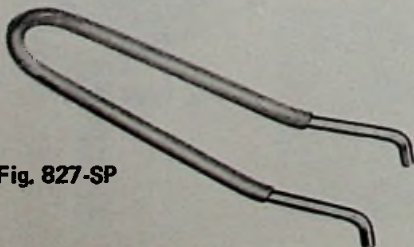

Fig. 827-SP



## CHROMALEX®

### TRANSOM OR UTILITY HANDLE – Fig. 1336-SP

Die Cast Zinc Alloy – Chromium Plated.  
Glossy Black Plastic Base. For ¼" Screws

Length Overall Inches	Length Inside Inches	Width Overall Inches
6-¼	3-½	1-¼

One Pair Per Card. – Six Cards Per Box.  
Weight Per Box, 7 Pounds.



Fig. 1336-SP



### ROUND GRIP TRANSOM HANDLE – Fig. 1231-SP

Die Cast Zinc Alloy – Chromium Plated.

Length Overall Inches	Length Inside Inches	Height Inside Inches	For Screw No.
6	3-½	1-5/16	10

One Pair Per Card. – Six Cards Per Box.  
Weight Per Box, 6½ Pounds.

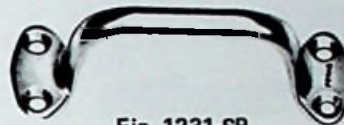

Fig. 1231-SP



### TRANSOM HANDLES – Fig. 775-SP

Silicon Bronze – Chromium Plated.

No.	Length Overall Inches	Length Inside Inches
2	5-¾	3-¾

One Pair Per Card. – Six Cards Per Box.  
Weight Per Box, 4 Pounds.



Fig. 775-SP



NEW

### “CHROMALEX” III® STEP PLATES—Fig. 1525 SP

Die Cast Zinc Alloy Frames – Chromium Plated  
Molded Teak Plastic Non-Skid Pads.

No.	Overall Dimensions	For Screw No.	Weight Per Box Pounds
0	8-3/8 x 2-1/4	8	6
1	8-3/4 x 3-1/4	8	9-1/2

One Pair Per Card.  
Six Cards Per Box.



Fig. 1525-SP



NEW



### CHROMALEX® STEP PLATES – Fig. 1325-SP

Die Cast Zinc Alloy – Polished Chromium Plated –  
Black Plastic Non-Skid Pads.

No.	Dimensions Overall Inches	For Screw	Weight Per Box Pounds
0	8-¾x2-¼	8	6
1	8-¾x3-¼	8	9-½

One Pair Per Card. – Six Cards Per Box.



Fig. 1325-SP



### STEP PLATES – Fig. 1225-SP

Die Cast Zinc Alloy – Chromium Plated –  
White Plastic Non-Skid Pads.

No.	Dimensions Overall Inches	For Screw	Weight Per Box Pounds
0	8-¾x2-¼	8	6
1	8-¾x3-¼	8	9-½

One Pair Per Card. – Six Cards Per Box.

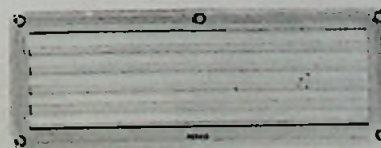

Fig. 1225-SP



Sold To Trade In Full Box Only



Fig. 1506-SP



**NEW**

**"CHROMALEX"® III OPEN BASE CLEATS—Fig. 1506-SP**  
 Die Cast Zinc Alloy Bodies — Chromium Plated  
 Black Plastic Bases — Molded Teak Plastic Insert.

	Length Inches	Size Base Inches	For Screw	For Diam. Rope Inches	Weight Per Box Pounds
No. 1	4-½	2-½-1-1/16	No. 10	¾	4
No. 2	6	3-¼x1-¾	¼"	½	4

No. 1 - One Pair Per Card. Six Cards Per Box.  
 No. 2 - One Cleat Per Card. Six Cards Per Box.



**NEW**

**"CHROMALEX"® III CLOSED BASE CLEAT—Fig. 1505-SP**  
 Die Cast Zinc Alloy Bodies — Chromium Plated  
 Black Plastic Bases — Molded Teak Plastic Insert.

	Length Inches	Size Base Inches	For Screw	For Diam. Rope Inches	Weight Per Box Pounds
No. 1	4-½	3-¾x1-1/16	No. 10	¾	4
No. 2	6	5x1-¾	¼"	½	4

No. 1 - One Pair Per Card. Six Cards Per Box.  
 No. 2 - One Cleat Per Card. Six Cards Per Box.



**CHROMALEX® OPEN BASE CLEATS — Fig. 1306-SP**

Black Plastic Base — Die Cast Zinc Alloy.  
 Chromium Plated — Counter Sunk for Screws.

Measurements Same as Fig. 1506-SP

No. 1 - One Pair Per Card. Six Cards Per Box.  
 No. 2 - One Cleat Per Card. Six Cards Per Box.



**CHROMALEX® CLOSED BASE CLEATS — Fig. 1305-SP**

Black Plastic Base — Die Cast Zinc Alloy.  
 Chromium Plated — Counter Sunk for Screws.

Measurements Same as Fig. 1505-SP

No. 1 - One Pair Per Card. Six Cards Per Box.  
 No. 2 - One Cleat Per Card. Six Cards Per Box.



**STREAMLINE CLEATS — Fig. 566-SP**

Die Cast Zinc Alloy — Chromium Plated.

Length Inches	Size Base Inches	For Diam. Rope Inches	Weight Per Box Pounds
2	2-3/16x1-½	5/16	3-½
3	3-½ x1-½	¾	5-½
4-½	4-7/16x1-7/8	½	8-½
6	5-½ x2	¾	13

2" and 3" - One Pair Per Box. Twelve Cards Per Box.  
 4½" - One Pair Per Card. Six Cards Per Box.  
 6" - One Cleat Per Card. Twelve Cards Per Box.



**YACHT CLEATS — Fig. 1188-SP**

Die Cast Zinc Alloy — Chromium Plated.

Length Inches	Width Base Inches	Weight Per Box Pounds
4	1-5/8	5
6	1-¾	4

4" - One Pair Per Card. Six Cards Per Box.  
 6" - One Cleat Per Card. Six Cards Per Box.

Sold To Trade In Full Box Only



Fig. 1505-SP

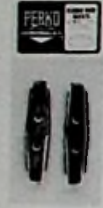

Fig. 1306-SP

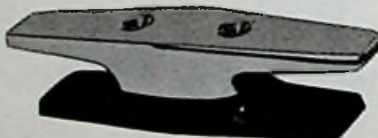

Fig. 1305-SP



Fig. 566-SP

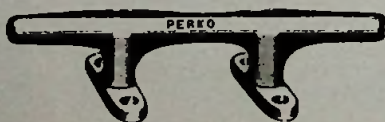
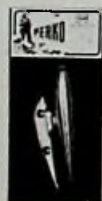

Fig. 1188-SP

### SOLID BASE CLEAT – Fig. 544-SP

Pressure Cast Bronze – Chromium Plated

Length Inches	For Screw No.
4	10

One Cleat Per Card.

Six Cards Per Box.

Weight Per Box, 2½ Pounds.

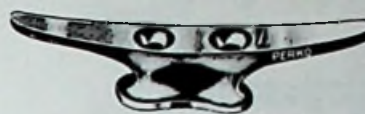

Fig. 544-SP



### CHROMALEX® SKENE TYPE BOW CHOCKS – Fig. 1307-SP

Black Plastic Base – Die Cast Zinc Alloy – Chromium Plated

– Counter Sunk for Screws.

No.	Length Overall Inches	Width Base	For Screw No.	For Diam. Rope Inches	Weight Per Box Pounds
1	3-1/2	7/8	No.10	3/8	3-1/2
2	5	1-1/4	1/4"	1/2	4

No. 1 - One Pair Per Card.

No. 2 - One Pair Per Card.

Twelve Cards Per Box.

Six Cards Per Box.



Fig. 1307-SP

### CHROMALEX® STRAIGHT TYPE CHOCKS – Fig. 1308-SP

Black Plastic Base – Die Cast Zinc Alloy – Chromium Plated

– Counter Sunk for Screws.

No.	Length Overall Inches	Width Base	For Screw No.	For Diam. Rope Inches	Weight Per Box Pounds
1	3-1/2	7/8	No.10	3/8	3-1/2
2	5	1-1/4	1/4"	1/2	4

No. 1 - One Pair Per Card.

No. 2 - One Pair Per Card.

Twelve Cards Per Box

Six Cards Per Box.



Fig. 1308-SP



### SKENE BOW CHOCKS – Fig. 1223-SP

Die Cast Zinc Alloy – Chromium Plated.

Length Overall Inches	Width Base Inches	For Diam. Rope Inches	Weight Per Box Pounds
3-1/2	7/8	1/2	4-1/2

One Pair Per Card.

Twelve Cards Per Box.



Fig. 1223-SP



### BOW CHOCKS – Fig. 546-SP

Cast Bronze – Chromium Plated.

Length Inches	For Screw No.	Weight Per Box Pounds
4	10	4

One Pair Per Card.

Six Cards Per Box.



Fig. 546-SP

### STERN CHOCK – Fig. 119-SP

Cast Bronze – Chromium Plated.

Length Inches	For Screw No.	Weight Per Box Pounds
4	8	2-1/2

One Chock Per Card.

Six Cards Per Box.



Fig. 119-SP



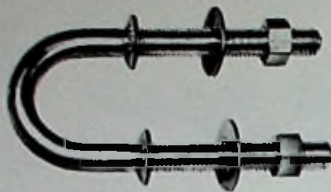

Fig. 237 SP

**BOW EYES – Fig. 237-SP**

18-8 Stainless Steel – Polished.

Length Shank Inches	Diameter Metal Inches	Length Thread Inches	Inside Eye Inches
3 1/4	5/16	3 1/4	1

One Per Card.

Six Cards Per Box.

Weight Per Box, 2 Pounds.

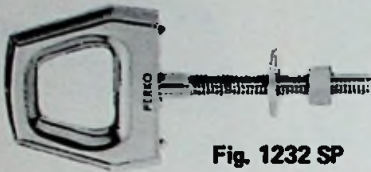

Fig. 1232 SP

**BOW EYES – Fig. 1232-SP**

Die Cast Zinc Alloy – Chromium Plated – Forged Steel Shank, Nut and Washer.

Length Shank Inches	Length Thread Inches	Diameter Shank Inches	Inside Eye Inches
3	2-1/2	3/8	1

One Per Card.

Six Cards Per Box.

Weight Per Box, 4 Pounds.



**BOW EYES Fig. 1235-SP**

Die Cast Zinc Alloy – Chromium Plated – Forged Steel Shanks, Nut and Washer – Shanks Are One Continuous “U” Bolt Cast Inside Eye.

Length Shank Inches	Length Thread Inches	Diameter Shank Inches	Inside Eye Inches
3	2-3/4	5/16	1

One Per Card.

Six Cards Per Box.

Weight Per Box, 4 1/4 Pounds.



**WATER SKI TOWING HOOK – Fig. 863-SP**

For Mounting Through Transom – Die Cast Zinc Alloy – Steel Bolt – Chromium Plated.

Length Overall Inches	Diameter Bolt Inches	Length Bolt Inches	Length Thread Inches
6	5/16	3-1/4	2-1/2

One Hook Per Card.

Six Cards Per Box.

Weight Per Box, 3 3/4 Pounds.



**HAND WINDSHIELD WIPERS – Fig. 533-SP**

The arm is extensible from 6 1/4 to 10 1/2 inches, spring tension is adjustable for best wiping pressure.

Length Overall Inches	Diam. Shaft Inches	Length Handle Inches
13 1/2 to 16 1/2	3/8	2-3/8

One Wiper Per Card.

Three Cards Per Box.

Weight Per Box, 2 Pounds.



Fig. 533 SP

## SWIVEL EYE PULLEYS – Fig. 565-SP

All 18-8 Stainless Steel except the sheave which is white nylon.

Length Overall Inches	Diam. Sheave Overall Inches	Length Strap Inches
3-3/4	2 5/16	1-5/8

One Pair Per Card.

Twelve Cards Per Box.

Weight Per Box, 4½ Pounds.



Fig. 565-SP

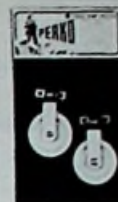

## SNAP HOOK PULLEYS – Fig. 634-SP

All 18-8 Stainless Steel except the sheave which is white nylon.

Length Overall Inches	Snap Throat Opening Inches	Diam. Sheave Overall Inches
4-5/8	1/2	2 5/16

One Pair Per Card.

Twelve Cards Per Box.

Weight Per Box, 5¼ Pounds.



Fig. 634-SP

## TILLER ROPE TIGHTENERS – Fig. 732-SP

Stainless Steel or Cadmium Plated.

Normal Length Inches	Length Compressed Inches	Outside Diameter Inches	Weight Per Box Pounds
4	5	1-1/16	5-1/2

STS. - One Pair Per Card.  
Twelve Cards Per Box.

Cad.- One Pair Per Card.  
Twelve Cards Per Box.



Fig. 732-SP – CAD.  
Fig. 732-SP – STS.



## TILLER ROPE CLAMPS – Fig. 1226-SP

Die Cast Zinc Alloy – Chromium Plated.

For Rope Diam. Inches	Length Inches	Width Inches
1/8 or 3/16	1-1/4	11/16

One Pair Per Card.

Twelve Cards Per Box.

Weight Per Box, 2½ Pounds.

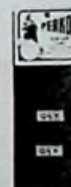

Fig. 1226-SP

## FENDER HOOKS – Fig. 1246-SP

Die Cast Zinc Alloy – Chromium Plated.

For Rope Diameter Inches	Size Plate Inches	For Screw No.
3/8	1-3/4x1-1/4	6

One Pair Per Card.

Twelve Cards Per Box.

Weight Per Box, 2¾ Pounds.

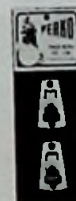

Fig. 1246-SP

## FENDER LOCK – Fig. 1299-SP

Die Cast Zinc Alloy – Chromium Plated.

Attach and detach fenders instantly, eye is permanently fastened to fender line, it quickly engages the deck flange and stays there until its job is done.

Diameter Flange Inches	I.D. Eye Inches	One Pair Per Card.
1-1/2	3/8	Twelve Cards Per Box.
		Weight Per Box, 2¼ Pounds.



Fig. 1299-SP

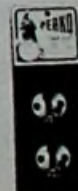

Sold To Trade In Full Box Only

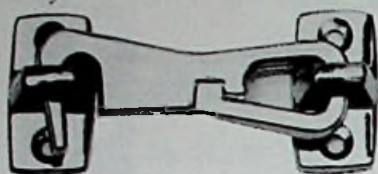

Fig. 1287-SP

**MODERN DESIGN CABIN DOOR HOOKS — Fig. 1287-SP**

Patented

Die Cast Zinc Alloy — Chromium Plated.

Length of Hook 2½ Inches.

Dimension of Eye Plate 1¼x11/16 Inches.

One Hook Per Card.

Six Cards Per Box.

Weight Per Box, 13 Ounces.



Fig. 1199-SP

**CABIN DOOR HOOKS — Fig. 1199-SP**

Die Cast Zinc Alloy — Chromium Plated.

Length of Hook 1¾ Inches.

One Hook Per Card.

Twelve Cards Per Box.

Weight Per Box, 2 Pounds.

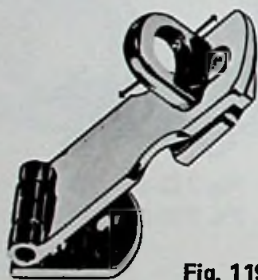

Fig. 1194-SP

**HINGED LOCKING HASP — Fig. 1194-SP**

Die Cast Zinc Alloy — Chromium Plated.

Padlock eye swivels to act as a latch.

Length Closed 3 Inches.

Width 1 Inch.

One Hasp Per Card.

Five Cards Per Box.

Weight Per Box, 1½ Pounds.

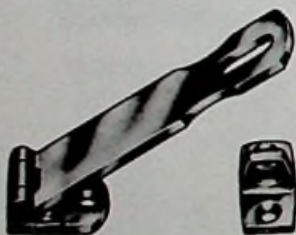

Fig. 1198-SP

**SECURITY HINGED HASPS — Fig. 1198-SP**

Die Cast Zinc Alloy — Chromium Plated.

Length Closed 3 Inches.

Width 1 Inch.

One Hasp Per Card.

Twelve Cards Per Box.

Weight Per Box, 2½ Pounds.

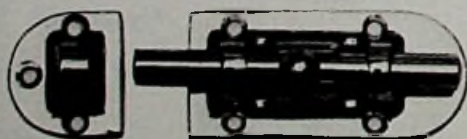

Fig. 947-SP

**BARREL BOLTS — Fig. 947-SP**

Pressure Cast Silicon Bronze — Chromium Plated.

Length of Rod 3 Inches.

Base Without Strike 3x1¼ Inches.

One Bolt Per Card.

Five Cards Per Box.

Weight Per Box, 1½ Pounds.



### BUTT HINGES – Fig. 1293-SP

Die Cast Zinc Alloy – Chromium Plated.  
Stainless Steel Removable Pin and Nylon Spacers –  
Smooth Operation.

Size Open 2x2 Inches.

One Pair Per Card.  
Ten Cards Per Box.  
Weight Per Box, 2¼ Pounds.



Fig. 1293-SP

### CUDDY DOOR HINGES – Fig. 808-SP

Die Cast Zinc Alloy – Chromium Plated.  
With Stainless Steel Pins.

Length Open 3 Inches.  
Extreme Width 1½ Inches.

One Pair Per Card.  
Ten Cards Per Box.  
Weight Per Box, 2¾ Pounds.



Fig. 808-SP



### CUDDY DOOR HINGE – Fig. 924-SP

Wrought Brass – Stainless Steel Pin.  
Chromium Plated.

Length Open Inches	Width Inches	Diam. Pin Inches
3	1-1/2	3/16

One Pair Per Card.  
Twelve Cards Per Box.  
Weight Per Box, 2 Pounds.

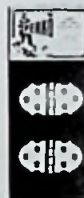

Fig. 924-SP

### HATCH HOLD-DOWN CLAMPS—Figs. 1112-SP & 1113-SP

Pressure Cast Silicon Bronze – Polished Chromium Plated.

An excellent item with many uses, on hatch covers, wind-  
shields, windows, bait and fish boxes, etc.

#### Fig. 1112-SP Flat Mounting

Length Inches	Width Inches
3	1-1/2

#### Fig. 1113-SP Angle Mounting

Length Inches	Width Inches
2-1/2	1-1/2

One Clamp Per Card.  
Three Cards Per Box.  
Weight Per Box, 1¼ Pounds.

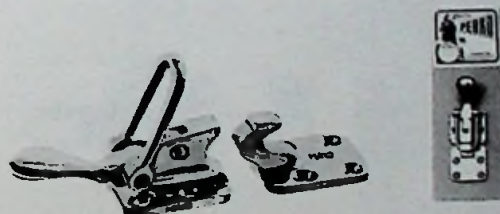

Fig. 1112-SP



Fig. 1113-SP

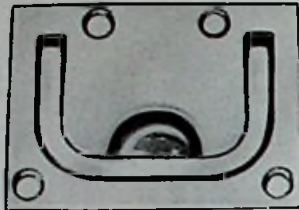

Fig. 1220-SP

**FLUSH HATCH LIFTING HANDLE – Fig. 1220-SP**  
 Die Cast Zinc Alloy – Chromium Plated.  
 No Large recess to catch chairs, heels, table legs, etc.

Dimensions Plate Inches	Inside Handle Inches
3x2-1/4	1-7/8x1

One Handle Per Card.  
 Ten Cards Per Box.  
 Weight Per Box, 2½ Pounds.

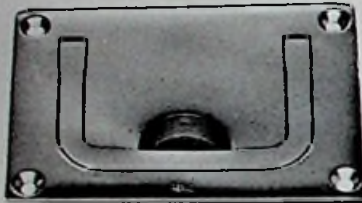

Fig. 776-SP

**HEAVY DUTY  
 FLUSH HATCH LIFTING HANDLE – Fig. 776-SP**  
 Silicon Bronze – Chromium Plated.

No.	Dimensions Plate Inches	Inside Handle Inches
1	3x2-1/4	1 7/8 x 1

One Handle Per Card.  
 Six Cards Per Box.  
 Weight Per Box, 1¼ Pounds.



Fig. 575-SP

**FLUSH HATCH LIFTING RING – Fig. 575-SP**  
 Silicon Bronze – Chromium Plated.  
 No recess to catch heels, chair or table legs, etc.  
 Size Plate 2x2-5/8 Inches – Inside Ring 1 Inch.

One Ring Per Card.  
 Twelve Cards Per Box.  
 Weight Per Box, 1½ Pounds.



Fig. 841-SP

**FLUSH RING PULLS – Fig. 841-SP**  
 Die Cast Zinc Alloy – Chromium Plated.  
 Size Plate 1¾x1-3/8 Inches.

One Pull Per Card.  
 Twelve Cards Per Box.  
 Weight Per Box, 1 Pound.

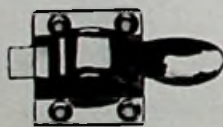

Fig. 1102-SP

**CUPBOARD CATCHES – Fig. 1102-SP**  
 Die Cast Zinc Alloy – Chromium Plated.  
 Base Without Strike 1-1/2 x 1-3/8 Inches.  
 Supplied complete with flush and 3/8 inch offset strike.

One Catch Per Card.  
 Six Cards Per Box.  
 Weight Per Box, 1 Pound.



Fig. 1101-SP

**CUPBOARD BOLT – Fig. 1101-SP**  
 Die Cast Zinc Alloy – Chromium Plated.  
 Base Without Strike 1½x1½ Inches.

One Bolt Per Card.  
 Six Cards Per Box.  
 Weight Per Box, 1¼ Pounds.

**ELBOW CATCHES – Fig. 1056-SP**  
 Die Cast Zinc Alloy – Chromium Plated.  
 Size of Base 1-1/8x9/16 Inches.

One Catch Per Card.  
 Twelve Cards Per Box.  
 Weight Per Box, 1 Pound.

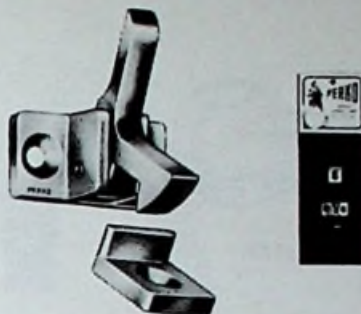

Fig. 1056-SP

**“POLYDEL” DOOR CATCHES – Fig. 559-SP**  
 Gray Delrin Ball Stud – Polyethylene Catch – Holds Door  
 Firmly in Place Against Vibration and Motion.

Stud Size Inches	Catch Size Inches
1-1/8x3/8	1-3/8x7/8

One Pair Per Card.  
 Twenty-Five Cards Per Box.  
 Weight Per Box, 1 Pound.

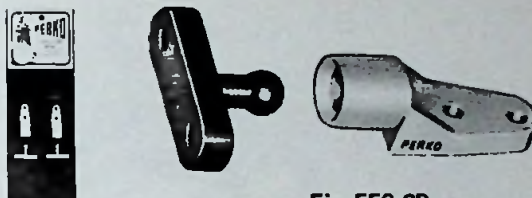

Fig. 559-SP

**SPRING TYPE DOOR BUTTON – Fig. 1216-SP**  
 Die Cast Zinc Alloy – Chromium Plated – Black Plastic Knob  
 Eliminates rattling doors. Phosphor bronze coil spring under knob holds button snugly against the plate. Drilled and counter-sunk for No. 6 screw.

Plate Diameter Inches	Width Less Keeper Inches
1-11/16	1-3/16

One Button Per Card.  
 Twelve Cards Per Box.  
 Weight Per Box, 1 1/4 Pounds.



Fig. 1216-SP

**SLIDING WINDOW LOCK AND ANTI RATTLER – Fig. 937-SP**

Die Cast Zinc Alloy – Chromium Plated – Bakelite Knob – Plastic Tip.

Height Overall Inches	Mounting Plate Inches	Length Screw Inches
1-5/8	1 x 5/8	1-1/8

One Pair Per Card.  
 Six Cards Per Box.  
 Weight Per Box, 2 Pounds.



Fig. 937-SP

**WARDROBE OR UTILITY HOOK – Fig. 610-SP**

Die Cast Zinc Alloy – Chromium Plated.

Projection Inches	Width Base Inches
1-3/8	1-1/8

Two Per Card.  
 Six Cards Per Box.  
 Weight Per Box, 10 Ounces.

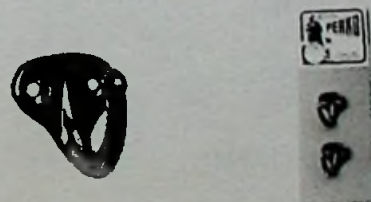
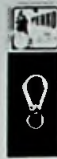

Fig. 610-SP



Fig. 1289-SP



**SWIVEL EYE SNAP – Fig. 1289-SP**

Die Cast Zinc Alloy – Chromium Plated.

Has an interlocking device on tongue and hook.

Inside Diam. Eye Inches	Extreme Length Inches
5/8	3

One Snap Per Card.

Twelve Cards Per Box.

Weight Per Box, 2½ Pounds.



**SAFETY MOORING HOOKS – Fig. 606-SP**

Galvanized Drop Forged Steel – Stainless Steel Spring.



Fig. 606-SP

No.	I.D. of Eye Inches	Length Overall Inches	Throat Opening Inches
1	3/4	4	3/4

One Hook Per Card.

Twelve Cards Per Box.

Weight Per Box, 2½ Pounds.



**SWIVEL EYE SNAP – Fig. 659-SP**

Cast Bronze.

Extreme Length Inches	Inside Eye Inches	Inside Hook Inches
3-1/2	3/4	7/16

One Snap Per Card.

Ten Cards Per Box.

Weight Per Box, 2 Pounds.



Fig. 659-SP

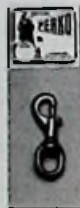

**RING BUOY HOLDERS – Fig. 1017-SP**

Brass – Chromium Plated.

Width Mounting Plate Inches	Hgt. Over- all Inches	For Screw No.
3	4-1/2	8

One Holder Per Card.

Four Cards Per Box.

Weight Per Box, 2½ Pounds.



Fig. 1017-SP

**LASHING HOOK – Fig. 1249-SP**

For Boat Covers

Die Cast Zinc Alloy – Chromium Plated.

Length Overall Inches	Width Overall Inches	Inside Hook Inches	For Screw No.
15/16	1/2	1/4	6

Six Hooks Per Card.

Ten Cards Per Box.

Weight Per Box, 2¼ Pounds.

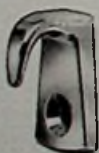

Fig. 1249-SP



## BOAT HOOK HOLDERS — Fig. 492-SP

18-8 Stainless Steel — Polished.

Will accommodate poles up to 1½ inch in diameter, and hold them firmly in place.

Length Inches	Width Inches	For Screw No.
3-1/2	1	6

One Pair Per Card.  
Twelve Cards Per Box.  
Weight Per Box, 3 Pounds.

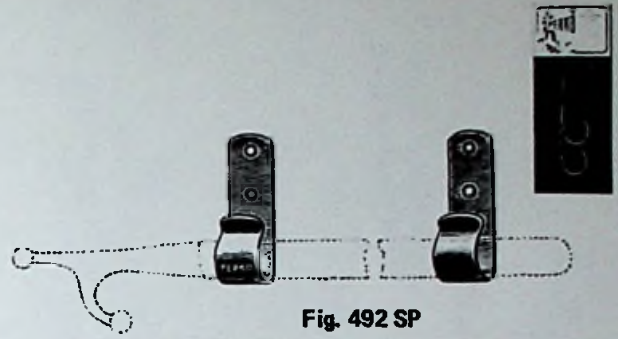

Fig. 492 SP

## “HOLDALL” SPRING CLAMPS — Fig. 502-SP

18-8 Stainless Steel — Polished.

Excellent for stowing fishing rods, boat hooks, oars, swab, broom, flashlight, flagstaff, pump, etc.

No.	Adjustability Inches	Length From Wall Inches	Width of Metal Inches	For Screw No.
1	5/8 to 1-1/4	1-1/2	1/2	6

One Pair Per Card.  
Twelve Cards Per Box.  
Weight Per Box, 3 Pounds.

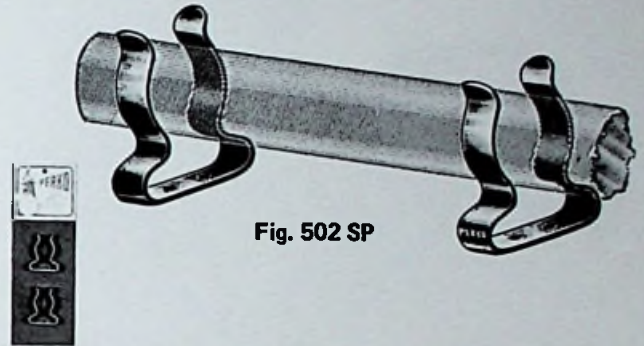

Fig. 502 SP

## CONVERTIBLE BOAT TOP FITTINGS — Fig. 395-SP

Die Cast Zinc Alloy — Chromium Plated.

No.	Item
1	Deck Hinge or Bracket
3	Socket for 3/4 inch tubing
6	Slide for 3/4 inch tubing

Two Fittings Per Card.  
Six Cards Per Box.  
Weight Per Box, 1¾ Pounds.

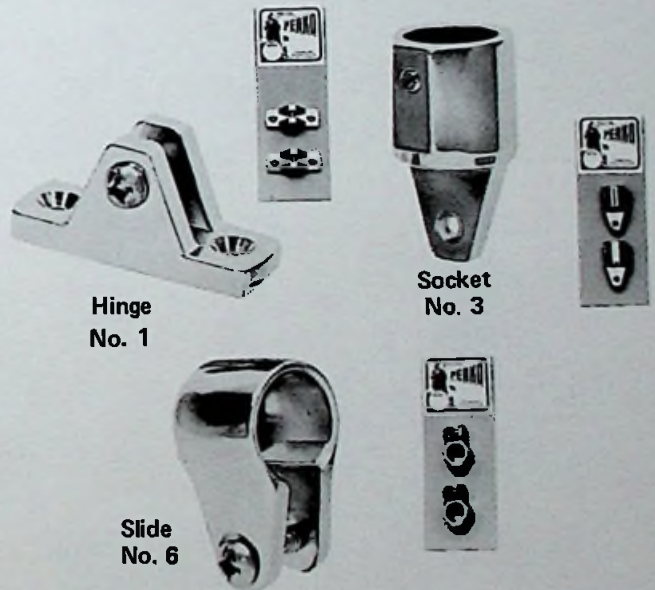

Hinge No. 1

Socket No. 3

Slide No. 6

Fig. 395-SP

## OUTRIGGER TROLLING PIN OR CLIP — Fig. 469-SP

High Impact Black Plastic — Stainless Steel Eyes and Spring — Sunlight and Salt Water Resistant.

Dimensions 2-3/4 x 1-3/8

One Pair Per Card.  
Six Cards Per Box.  
Weight Per Box, 3 Pounds.



Fig. 469-SP



**NEW**

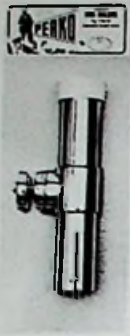
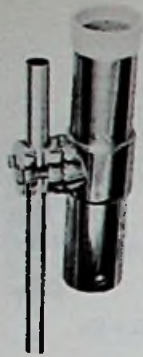

Fig. 1118-SP

**CLAMP-ON  
FISHING ROD HOLDER – Fig. 1118-SP  
CHROMIUM PLATED**

Clamp-on feature eliminates drilling of rail.  
For Mounting On Vertical or Horizontal Rails.  
Complete with full length Inner Liner.

Inside Diameter Liner Inches	Outside Diameter Tube Inches	Length Inches	For Rails Diameter Inches
1-3/4	2	9	3/4 to 1

One Holder Per Card.  
Three Cards Per Box.  
Weight Per Box, 4 1/2 Pounds.

**IMPROVED**



Fig. 1205-SP

**FISHING ROD HOLDER – Fig. 1205-SP**

Chromium Plated Flange – Anodized Aluminum Tube –  
Soft White Vinyl Liner and Full Length Inner Liner.

Inside Diameter Liner Inches	Outside Diameter Tube Inches	Length Under Flange Inches	Dimensions Flange Inches
1 1/2	2	8	4 1/4 x 3 1/2

One Holder Per Card.  
Four Cards Per Box.  
Weight Per Box, 4 1/2 Pounds.

**IMPROVED**



Fig. 1104-SP

**FISHING ROD HOLDER—Fig. 1104-SP  
Black Plastic With Chromium Plated Brass Brackets.**

Length Overall Inches	Inside Diameter Inches	Outside Diameter Inches	Width Bracket Inches
9	1 3/4	2	3 1/4

One Holder Per Card.  
Six Cards Per Box.  
Weight Per Box, 4 Pounds

**IMPROVED**

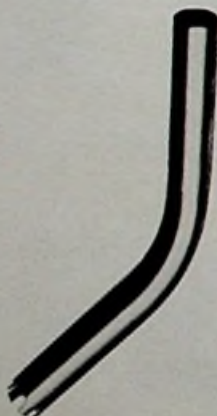

Fig. 1314-SP

**OUTRIGGER POLE HOLDER  
DECK MOUNT – Fig. 1314-SP**

Chromium Plated Plates.  
Stainless Steel Tubes  
Use with Fiberglass Outrigger Poles.

No.	Outside Diameter Tube Inches	Inside Diameter Tube Inches	Dimensions Plate Inches
1	1 1/4	1.125	5 x 2 1/2

One Pair Per Card.  
Four Cards Per Box.  
Weight Per Box, 10 Pounds.

# PERKO®

## SECTION M

### Chromalex® III

### Lights and Deck Fittings



MANUFACTURED BY PERKO, INC., 16490 N.W. 13TH AVE., P.O. BOX 64000-D, MIAMI, FLORIDA 33164

FOR COMPLETE LINE SEE CATALOG NO. 230

© PERKO, INC.  
ALL RIGHTS RESERVED

PORTIONS OF THIS CATALOG PREVIOUSLY  
COPYRIGHTED IN 1936 THRU 1976 INCLUSIVE.

# Chromalex® III Lights

**NEW CHROMALEX® III** offers the elegance of TEAK combined with strong functional hardware. The precision die cast bodies are protected by our exclusive PERKOPLATE six step plating process for beauty and durability. The thick, high impact plastic inserts are ultra-sonically welded in place and like the tough ebony bases are impervious to fiber-glass cleaners, including acetone and all the corrosive conditions of the sea.

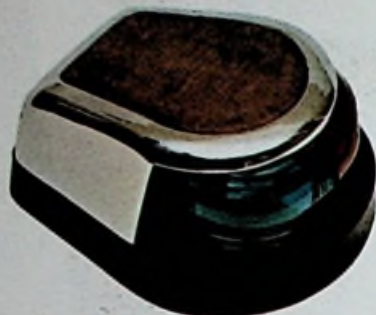

FIG. 1510

## COMBINATION BOW LIGHT – Fig. 1510

20 Points – 225 Degrees – 1 Mile Visibility

Red and Green Fresnel Lenses

Delrin Non-Corrosive Electric Socket

Certified and Supplied with a No. 1004, 12 Volt Lamp.

Each	Size Base	Height Inches	Screw No.	Weight Ounces
	4x3-1/8	1-7/8	8	5-1/2

OEM Package, 50.

Spare Lenses – 283R-Red, 283-G Green.

Spare Lamps (Bulbs), See Fig. 337 No. 12.

Spare Electric Sockets, See Fig. 24 No. 1.

## STERN POLE LIGHTS

32 Points – 360 Degrees – 2 Mile Visibility

Modern Frosted Globes

Delrin Non-Corrosive Electric Sockets

Certified and Supplied with a No. 1004, 12 Volt Lamp



FIG. 1511

### FIG. 1511 – TELESCOPING TYPE

Equipped with a Positive and Unique Tightening Device for Adjusting the Height or Removing the Pole from the Base. No Metal to Metal Contact or Threads to Corrode and Freeze up.

### FIG. 1530 – STOW-A-WAY TYPE

Has same Tightening Device as Fig. 1511. Female Double Contact Connector in Bottom of Pole, Male Connector in Mounting Base, Completes Contact When Pole is Inserted in Base. A Plastic Cap is Attached to Base to Waterproof the Opening when Pole is Removed.



FIG. 1530

No.	Fig. 1511 Each	Fig. 1530 Each	Maximum Length Inches	Weight Pounds
2			24	7/8
3			30	1
4			36	1-1/8

Base Dimensions – 3-5/8" Long, 1-1/2" Wide.

OEM Package, 50.

Spare Globes, Specify Fig. 201.

Spare Lamps (Bulbs), See Fig. 337 No. 12.

Spare Electric Sockets, See Fig. 24 No. 2.



# Chromalex® III Cleats

M-3



FIG. 1505

FIG. 1505—CLOSED BASE CLEATS

For Screws or Bolts.

No.	Each	Length Overall Inches	Base Inches	For Rope Inches	For Screw No.	Weight Ounces
1		4-1/2	3-3/4x1-1/16	3/8	10	5-1/2
2		6	5 x1-3/8	1/2	1/4"	11

O.E.M. Package, 50 Pieces.



FIG. 1515

FIG. 1515—CLOSED BASE CLEATS

With Studs, Nuts and Washers.

No.	Each	Length Overall Inches	Base Inches	For Rope Inches	Stud Size	Weight Ounces
1		4-1/2	3-3/4x1-1/16	3/8	12-24x1-1/2	5-1/2
2		6	5 x1-3/8	1/2	1/4-20x1-1/2	11

O.E.M. Package, Size No. 1—50 Pieces, Size No. 2—40 Pieces.



FIG. 1506

FIG. 1506—OPEN BASE CLEATS

For Screws or Bolts.

No.	Each	Length Overall Inches	Base Inches	For Rope Inches	For Screw No.	Weight Ounces
1		4-1/2	2-1/2x1-1/16	3/8	10	5
2		6	3-1/4x1-3/8	1/2	1/4"	10
3		8	3-7/8x1-1/2	3/4	1/4"	12

O.E.M. Package, 50 Pieces.



FIG. 1516

FIG. 1516—OPEN BASE CLEATS

With Studs, Nuts and Washers.

No.	Each	Length Overall Inches	Base Inches	For Rope Inches	Stud Size	Weight Ounces
1		4-1/2	2-1/2x1-1/16	3/8	12-24x1-1/2	5
2		6	3-1/4x1-3/8	1/2	1/4-20x1-1/2	10
3		8	3-7/8x1-1/2	3/4	1/4-20x1-1/2	12

O.E.M. Package, Size No. 1—50 Pieces, Size No. 2— 40 Pieces, Size No.3—30 Pieces.

CHROMALEX® I, II, and III fittings are precision cast to assure uniformity and interchangeability . . . a feature which eliminates costly jig and tooling changes for builders and allows the individual boat owner to change hardware styles with a minimum of effort. See Catalog No. 230 for complete details on CHROMALEX® I and II lights and deck fittings.

# Chromalex® III Deck Fittings



FIG. 1512

FIG. 1512—COWL VENTILATOR

Designed for fast mounting.  
No Screw Heads will show. Has integral Air Scoop.  
No Hose Clamps Necessary—Duct threads into collar.

Each	Mouth Opening Square Inches	Length Overall Inches	Width Overall Inches	Height Overall Inches	O.E.M. Package	Weight Ounces
	7	5-3/4	4-3/8	2-5/8	50	11



FIG. 1513

FIG. 1513—GAS FILL

Molded Teak Plastic Floating Cap.  
Neck has bead for improved hose retention.  
Designed to meet the requirements of U.S.C.G. Safety Standards,  
January 31, 1977

Each	Diameter Overall Inches	Length Hose Neck Inches	For Hose Inches	For Screw No.	O.E.M. Package	Weight Ounces
	3-1/8	1-5/8	1-1/2	7	50	7

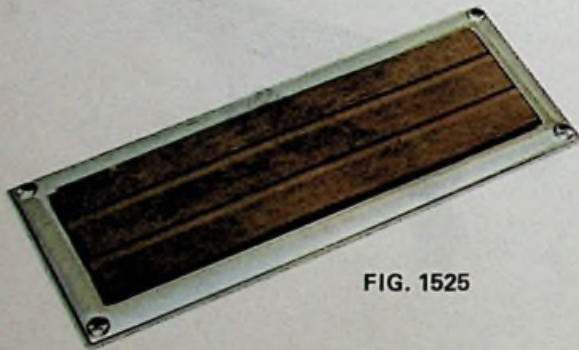

FIG. 1525

FIG. 1525—STEP PLATES

Die Cast Zinc Alloy Frames—Chromium Plated.  
Molded Teak Plastic Non-Skid Pads.

No.	Each	Overall Dimensions Inches	For Screw No.	Standard Package	Weight Ounces
0		8-3/8x2-1/4	8	10	5
1		8-3/4x3-1/4	8	10	5

MANY OF THESE FITTINGS ARE AVAILABLE IN SKIN PACK, SEE CATALOG NO. 230, SECTION "L".

## ALPHABETICAL INDEX

A	PAGE
Acorn Nuts .....	I-29
Adapters —	
Electric ...	A-20, B-7, 16, C-7
For Exhaust Duct .....	F-3
Pipe to Hose .....	H-17
Adjusters —	
Hatch .....	J-9
Windshield .....	J-8, 9
All-Round Lights ...	B-3 to 8, 10 to 14
Anchor Chocks .....	I-11
Anchor Lights ...	A-8, 10, 11, 18, B-3 to 8, 10 to 14
Anchor Shackles .....	I-28
Anti-Collision Light ...	A-17
Anti-Rattler .....	J-10, 11
Ash Trays .....	G-5
Assemblies, Control .....	E-6
Axe Brackets .....	I-25
<b>B</b>	
Bass Boat Lights .....	A-5
Bells —	
Fog .....	G-6, 7
Smoke .....	D-8
Berth Lights .....	D-3
Bits .....	I-5
Blinker Signal Lights ...	B-15
Blocks .....	I-32
Blower & Ignition	
Switches .....	F-2
Blowers .....	F-2
Boarding Steps .....	I-17
Boat —	
Cover Sockets .....	J-18
Hook Holders .....	I-24
Hooks .....	I-25
Snaps .....	I-26,27
Top Fittings .....	J-18
Bolts —	
Barrel .....	J-5
Cupboard .....	J-3
Ship .....	J-5
Books, Log .....	G-8
Bow —	
& Anchor Lights ...	A-10, 11
Combination ...	A-3 to 11, M-2
Eyes .....	I-12 to 14
Lifting Handles .....	I-14
Boxes, Stuffing .....	H-3 to 5
Brackets —	
Axe .....	I-25

B - Contd.	PAGE
Mounting .....	A-7, 11, 20 & B-16
Table .....	I-22
Breakdown Lights ...	B-3 to 8, 10 to 14
Bulbs, Electric ..	C-11 & E-5, 6 B-3, 4, 7
Burners —	
Oil .....	A-20 & B-16
Butt Hinges .....	J-12
Buttons —	
Door .....	J-5
Horn Push .....	C-5, 9

## C

Cabin —	
Door Hooks .....	J-4
Lamps, Oil .....	D-8
Cabinet Hinges .....	J-13, 14
Cable —	
Outlets .....	C-9
Straps .....	C-7
Can Holder .....	G-5
Cans, Oil .....	H-18
Caps, Gas Tank .....	H-7
Casing —	
Bowden .....	H-9
Clamps .....	H-9
Catches, Door .....	J-6
Caulking Irons .....	I-29
Chain —	
Deck Pipe .....	I-5
Portlight .....	G-4
Chimneys .....	B-16, D-8
Chocks .....	I-8 to 11
Chocks, Anchor .....	I-11
Choke Controls .....	H-9
Clam Shell Ventilators ...	F-4
Clamps —	
Bowden Casing .....	H-9
Gas Tank .....	F-7
Hatch Hold-Down ...	J-10
Hose .....	H-4, 5
Spring .....	I-24
Tiller Rope .....	I-31
Cleats ...	I-2 to 4, 6, 7, 14, M-3
Clips —	
Line Support .....	C-7
Trolling .....	K-2
Wire Rope .....	I-28
Coat & Hat Hooks .....	J-16
Cockpit Scupper .....	H-19
Cocks, Sea .....	H-14
Collars —	

## C - Contd.

C - Contd.	PAGE
Electrolysis .....	H-10
Rudder .....	H-3
Combination —	
Bow & Anchor	
Lights .....	A-10, 11
Bow Lights ...	A-3 to 5, M-2
Connections —	
Electric .....	C-8,9
Thru-Hull .....	H-15, 16
Connectors, Electric ...	C-9
Continuous Hinge ...	J-15
Control —	
Assemblies .....	E-6
Parts .....	H-9
Convertible Boat Top —	
Fittings .....	J-18
Course Protractors .....	G-8
Cowl Ventilators ...	F-3, 4, M-4
Cupboard —	
Bolts .....	J-3
Catches .....	J-3
Turns .....	J-3
Curtain-Fasteners .....	J-19

## D

Deck —	
Lights .....	G-3
Pipes, Rope & Chain ...	I-5
Plate Keys .....	H-8
Plates .....	H-6, 7, 8
Straps .....	I-25
Dividers .....	G-8
Dock Line Springs .....	I-23
Dome Lights .....	D-4, 5
Door —	
Buttons .....	J-5
Catches .....	J-6
Fasteners .....	J-10
Hinges .....	J-13, 14
Holders .....	J-4, 5
Hooks .....	J-4
Stops .....	J-4, 5
Drain Fittings for Sink ...	G-5
Drain Plugs .....	H-20
Drainer .....	H-19
Drawer —	
Knobs .....	J-16
Pulls .....	J-7, 16
Dredging Light .....	B-10
Duct, Adapters .....	F-3
Duct, Exhaust .....	F-3

## E

Elbow Catches .....	J-6
---------------------	-----

Electric —  
 Adapters.....A-20, B-7, 16, C-7  
 Bulbs..B-3, 4, 7, C-11, E-5, 6  
 Cabin Fixtures.....D-2 to 8  
 Connections.....C-9  
 Connectors.....C-8, 9  
 Lamps.....B-3, 4, 7, C-11, E-5, 6  
 Sockets....A-19, B-16, C-7  
 Switches.....C-2 to 6  
 Electrolysis  
 Eliminators.....H-10, 11  
 Exhaust —  
 Blowers.....F-2  
 Duct.....F-3  
 Fittings.....H-17  
 Eyes —  
 Bow.....I-12 to 14  
 Flange.....I-25  
 Halyard.....A-7  
 Lashing.....I-13  
 Lifting.....I-14  
 Pad.....I-13  
 Transom.....I-13

F

Fans, Exhaust.....F-2  
 Fasteners —  
 Curtain.....J-19  
 Door.....J-10  
 Hatch.....J-9  
 Sash.....J-10  
 Table Leg.....J-11  
 Fender —  
 Hooks.....I-23  
 Locks.....I-23  
 Fids, Hand.....I-29  
 Filler, Tank.....H-6, 7, M-4  
 Filters, Fuel.....H-12  
 Filters, Water.....H-13  
 Fishing —  
 Pole Holders.....K-4 to 9  
 Pole Liners.....K-9  
 Fittings —  
 For Boat Top.....J-18  
 For Rails.....I-20, 21, 22  
 Waste.....H-7  
 Fixtures —  
 Bulkhead.....D-2  
 Electric Cabin.....D-2 to 8  
 House.....D-6, 7  
 Vapor Proof.....B-15  
 Flag Pole —  
 Lights.....A-4, 14  
 Sockets.....I-22  
 Flag Staffs.....A-9  
 Flange Eyes.....I-25  
 Flanges, Exhaust.....H-17

Flush —  
 Hatch Lifting Handles..J-7  
 Hatch Liftings Rings..J-7  
 Pulls.....J-7, 16  
 Ring Catch.....J-3  
 Fog Horns.....G-7  
 Founts Oil.....A-20, B-16  
 Frames for Windows.....G-2  
 Fresnel —  
 Globes.....A-19, D-6  
 Lenses.....A-19, B-16  
 Fuel —  
 Filter.....H-12  
 Separator.....H-12  
 Strainer.....H-12  
 Tank Filler.....H-7  
 Fuse —  
 Holder.....C-2, 6, 9  
 Panels.....C-6

G

Galley —  
 Pumps.....H-18  
 Sinks.....G-5  
 Gas —  
 Strainers.....H-12  
 Tank Caps.....H-7  
 Tank Clamps.....F-7  
 Tank Filler.....H-7, M-4  
 Tank Vents.....F-5  
 Glass Holders.....G-5  
 Globes.....A-19, D-6, M-2  
 Grab Rail Posts.....I-20  
 Grab Rails.....I-20, 21  
 Guides, Tiller Rope.....I-30  
 Guides, Pole Line.....K-2

H

Halyard Eyes.....A-7  
 Hand Fids.....I-29  
 Handles —  
 Bow.....I-14  
 Choke Control.....H-9  
 Hatch Lifting.....J-7  
 Sliding Window.....J-11  
 Transom.....I-15  
 Hasps.....J-17  
 Hatch —  
 Adjusters.....J-9  
 Fasteners.....J-9  
 Hinges.....J-15  
 Hold-Down Clamps..J-10  
 Lifting Handles.....J-7  
 Lifting Rings.....J-7  
 Support Hinges.....J-10  
 Hawse Hole Plate.....I-4  
 Hinges —  
 Butt.....J-12

Butterfly.....J-14  
 Cabinet.....J-13, 14  
 Continuous.....J-15  
 Cuddy Door.....J-13, 14  
 Flap.....J-14  
 Hatch.....J-15  
 Hatch Support.....J-10  
 Ladder.....J-17  
 Non-Mortised.....J-14  
 Piano.....J-15  
 Pull-Out.....J-15  
 Rail.....I-22  
 Semi-Concealed.....J-14  
 Shortside.....J-12, 13  
 Strap.....J-12  
 "T".....J-12  
 Holders —  
 Boat Hook.....I-24  
 Can or Glass.....G-5  
 Door.....J-4, 5  
 Fishing Pole.....K-4 to 9  
 Ring Buoy.....I-25  
 Outrigger Pole....K-4, 5, 6  
 Hooks —  
 Boat.....I-25  
 Cabin Door.....J-4  
 Coat & Hat.....J-16  
 Fender.....I-23  
 Ladder.....I-17  
 Lashing.....J-18  
 "S".....I-27  
 Safety Mooring.....I-26  
 Ski Towing.....I-13  
 Snap.....I-26, 27  
 Utility.....J-16  
 Wardrobe.....J-16  
 Horn Push Button....C-5, 9  
 Horns, Fog.....G-7  
 Horns, For Rowlocks..I-18, 19  
 Hose Clamp.....H-4  
 House Fixtures.....D-6, 7  
 Hull Connections...H-15, 16

I

Indicator Lights.....C-10  
 Inlet —  
 Connections.....H-15, 16  
 Fittings for Fresh  
 Water.....H-18  
 Strainers.....H-15, 16  
 Irons, Caulking.....I-29

K

Keel Plates.....I-14  
 Keys, Deck Plate.....H-8  
 Knobs, Drawer.....J-16

L

Ladder —  
 Hinges.....J-17

L - Contd.	PAGE
Hooks .....	I-17
Locks .....	I-17
Lamps —	
Cabin .....	D-3, 8
Dashboard .....	C-10
Electric .....	C-11, E-5, 6
Wall .....	D-8
Lanterns—	
Bulkhead .....	D-6
Navy or Lifeboat .....	D-6
Ships .....	D-6, 7
Lashing Eyes .....	I-13
Lashing Hooks .....	J-18
Latches —	
Doors .....	J-2, 3
Lavatory Pumps .....	H-18
Lead Lines .....	G-4
Leads, Sounding .....	G-4
Leathers, Oar .....	I-18
Lenses, Fresnel ...	A-19, B-16
Lifting Eyes .....	I-14
Lights —	
All-Round .....	B-3 to 8, 10 to 14
Anchor ..	A-8, 10, 11, 18, B-3 to 8, 10 to 14
Anti-Collision Light ...	A-17
Bass Boat .....	A-5
Berth .....	D-3
Bow .....	A-3 to 5, 10 to 14, 16 to 18
Breakdown .....	B-3 to 8, 10 to 14
Combination .....	A-3 to 5, 10, 11
Deck .....	G-3
Dredging Light .....	B-10
Distress or Globe .....	D-6
Dome .....	D-4, 5
Double Lens .....	B-3, 10
Flag Pole .....	A-4, 14
For Windshield	
Mounting ...	A-7, 10, 11
Indicator .....	C-10
Mast .....	A-8, 11, 16
Masthead ...	A-14, 16, B-3 to 7, B-10 to 14
Meal & Absent .....	A-9
Not under-Command ..	B-3 to 8, 10 to 14
Pole .....	A-6 to 8, 10, 11
Range ...	B-3 to 7, 10 to 14
Searchlights .....	E-2 to 8
Side ...	A-12 to 14, 16 to 18 B-3 to 7, 10 to 14
Signal ..	A-8, B-3 to 8, 10 to 14
Spreader .....	A-9
Stern ..	A-6, 8, 13, 15, 17, 18 B-3 to 7, 10-14
Strobe .....	A-17
Towing ...	B-3 to 7, 10 to 14

L -Contd.	PAGE
Utility .....	D-5
Vapor-Proof .....	B-15
Line Support Clips .....	C-7
Lines, Lead .....	G-4
Locks —	
Doors .....	J-2, 3
Fender .....	I-23
Ladder .....	I-17
Window .....	J-11
Log Books .....	G-8
Logs, Shaft .....	H-5
Louver Ventilators .....	F-7

M

Mast Lights .....	A-8, 11
Masthead Lights ...	A-14, 16 B-3 to 7, 10 to 14
Meal and Absent Light ...	A-9
Mooring Bitts .....	I-5
Mooring Hook .....	I-26

N

Name Plates, Switch ...	C-2, 3
Nuts —	
Acorn .....	I-29
Flanged .....	H-17
Lock .....	H-4
Packing .....	H-4
Wing .....	I-29

O

Oar —	
Leathers and Buttons ..	I-18
Locks .....	I-18, 19
Oilers, Zinc .....	H-18
Outboard Motor Transom	
Plates .....	I-19
Outlet Connections ..	H-15, 16
Outlets —	
Cable .....	C-9
Water .....	H-18
Outrigger —	
Holders .....	K-4, 5, 6
Kit .....	K-2
Pole Line Guides .....	K-2
Poles .....	K-2, 3
Spreaders .....	K-3
Trolling Pin .....	K-2

P

Pads, Step .....	I-16
Paint Scraper .....	I-29
Palms, Sewing .....	I-29
Panels —	
Fuse .....	C-6
Switch .....	C-2, 3
Parallel Rules .....	G-8
Piano Hinge .....	J-15

P - Contd.	PAGE
------------	------

Pins —	
Brass .....	I-27
Trolling .....	K-2
Pipes, Rope Deck .....	I-5
Plates —	
Deck .....	H-6, 7, 8
Hawse Hole .....	I-4
Keel .....	I-14
Step .....	I-16, M-4
Transom .....	I-19
Plugs, Drain .....	H-20
Pole Holders —	
Outrigger .....	K-4, 5, 6
Pole Lights .....	A-6 to 8, 10, 11, M-2
Pole Sockets .....	I-22
Poles —	
Flag .....	A-9
Outrigger .....	K-2
Portlights .....	G-2, 3
Ports, Rudder .....	H-3
Posts —	
Grab Rail .....	I-20
Stanchion .....	I-20
Protractors, Course .....	G-8
Pulleys .....	I-30, 32
Pulls —	
Drawer .....	J-7, 16
Flush .....	J-7, 16
Pump Strainers .....	H-19
Pumps —	
Galley .....	H-18
Lavatory .....	H-18

R

Rail —	
Fittings .....	I-20, 21, 22
Hinges and Locks .....	I-22
Rails, Grab .....	I-20
Range Lights .....	B-3 to 7, 10 to 14
Rim Locks .....	J-2
Ring —	
And Deck Straps .....	I-25
Buoy Holders .....	I-25
Catches, Flush .....	J-3
On Plate .....	I-13
Pulls .....	J-7, 16
With Straps .....	J-13
Rings —	
Brass .....	I-13
Hatch Lifting .....	J-7
Rope —	
Clamps .....	I-31
Clips .....	I-28
Deck Pipe .....	I-5
Guides .....	I-30
Pulleys .....	I-30, 32
Thimbles .....	I-28
Rope Tighteners .....	I-31
Rowlocks .....	I-18, 19

R - Contd.	PAGE
Rudder —	
Collars .....	H-3
Ports .....	H-3
Stuffing Boxes .....	H-3
Rudders .....	H-3
Rules, Parallel .....	G-8
S	
"S" Hooks .....	I-27
Safety Cords .....	H-6
Sash —	
Anti-Rattler .....	J-10, 11
Fasteners .....	J-10
Scrapers .....	I-29
Screens, Portlight .....	G-3
Scupper, Cockpit .....	H-19
Seacocks .....	H-14
Sealed Beam Units .....	E-6
Searchlight Bulbs .....	E-5, 6
Searchlight Controls .....	E-6
Searchlights .....	E-2 to 8
Separator, Fuel .....	H-12
Shackles .....	I-28
Shades for Cabin	
Fixtures .....	D-2
Shaft Logs .....	H-5
Sheaves, Rope .....	I-27
Shields—For Combination	
Bow and Anchor Light .....	A-10
For Fixtures .....	D-2
For Pole or Mast Lights .....	A-7
Side Lights .....	A-12 to 14, 16, 17, 18, B-3 to 7, 10 - 14
Signal Lights, Portable	
or Fixed .....	A-8, B-3 to 8, 10 to 15
Sinks, Galley .....	G-5
Ski Towing Hooks .....	I-13
Skin Packed Products Sec. L.	
Smoke Bell & Arm .....	D-8
Snap Hooks .....	I-26, 27
Sockets —	
Boat Cover .....	J-18
Electric .....	A-19, B-16 & C-7
Fishing Rod .....	K-6 to 9
Flag Pole .....	I-22
Rowlocks .....	I-18, 19
Staff .....	A-9
Supports .....	B-16
Sounding Leads .....	G-4
Spotlights .....	E-8
Spreaders .....	K-3
Spreader Lights .....	A-9
Spring Clamps .....	I-24
Springs for Dockline .....	I-23
Spring, Tiller Rope .....	I-31
Staffs, Flag .....	A-9
Steerer Parts .....	H-9
Steering Wheels .....	H-2

S - Contd.	PAGE
Steps —	
Boarding .....	I-17
Folding .....	I-17
Step Pads .....	I-16
Step Plates .....	I-16, M-4
Stern —	
Lights .....	A-8, 13, 15, 17, 18, B-3 to 7, 10 to 14, M-2
Pole Lights .....	A-6, 7, M-2
Stop —	
Door .....	J-5
Window .....	J-11
Strainers —	
Fuel .....	H-12
Gasoline .....	H-12
Hull .....	H-15, 16
Inlet .....	H-15, 16
Pump .....	H-19
Water .....	H-12, 13
Strap Hinges .....	J-12
Straps	
Cable .....	C-7
Deck .....	I-25
Eye .....	I-31
Strobe Light .....	A-17
Struts .....	H-5
Stuffing Boxes .....	H-3 to 5
Stuffing Box Nuts .....	H-4
Switch —	
Name Plate .....	C-2, 3
Panels .....	C-2, 3
Switches —	
Blower & Ignition .....	F-2
Electric .....	C-2 to 6
Panels .....	C-2, 3
Swivel —	
Eye Blocks .....	I-32
Eye Pulleys .....	I-30
Eye Snaps .....	I-26, 27
T	
"T" Hinges .....	J-12
Table Brackets .....	I-22
Table Leg Fasteners .....	J-11
Terminal Blocks .....	C-6
Thimbles, Rope .....	I-28
Thru-Hull Connections .....	H-15, 16
Tiller —	
Rope Clamps .....	I-31
Rope Guides .....	I-30
Rope Pulleys .....	I-30
Rope Tighteners .....	I-31
Towing Hooks .....	I-13
Towing Lights .....	B-3 to 7, 10 to 14
Transom —	
Eyes .....	I-13
Handles .....	I-15

T - Contd.	PAGE
Plates .....	I-19
Stern Light .....	A-15
Ventilators .....	F-3 to 7, M-4
Trays, Ash .....	G-5
Trim, Hatch .....	J-15
Trolling Pin .....	K-2
Tubing, Grab Rail .....	I-20
Turnbuckles .....	I-28
Turns, Cupboard .....	J-3
U	
Utility Hooks .....	J-16
Utility Lights .....	D-5
V	
Vapor Proof Fixtures .....	B-15
Ventilator —	
Cowl .....	F-3, 4, M-4
Gas Tank .....	F-5
Locker .....	F-6
Louver .....	F-7
Shell Type .....	F-4
Transom .....	F-6
Ventilators .....	F-3 to 7, M-4
Vinyl for Portlights .....	G-4
W	
Wardrobe Hooks .....	J-16
Waste Fitting .....	H-7
Water Strainers .....	H-13
Wheels, Steering .....	H-2
Whistles .....	G-7
Wicks .....	A-20, B-16
Window —	
Handle, Sliding .....	J-10
Lock .....	J-11
Stop .....	J-11
Windows .....	G-2
Windshield —	
Adjusters .....	J-8, 9
Keeper & Plate .....	J-9
Pole Light for — .....	A-7, 10, 11
Wipers .....	I-24
Wing Nuts .....	I-29
Wire —	
Bowden .....	H-9
Rope Clips .....	I-28
Rope Pulleys .....	I-32
Rope Thimbles .....	I-28
Z	
Zincs .....	H-10,11



**Numerical Index With List Price  
And Standard Package Quantities Applying To Catalog No. 230 - 1978**

Figure	Page	Size	List Price	Std. Pkg.	Figure	Page	Size	List Price	Std. Pkg.				
O-2	A-18		<b>JUNIOR ANCHOR LIGHTS</b>		7-D	B-7	C/3	Galv Pol Br Chrome					
O-2A			Galv	Pol Br	7-MD			C/3		Each Each Each			
O-2RA		\$24.50 Ea	\$ 36.00 Ea										
O-2GA		24.50 Ea	36.00 Ea										
O-2MA		24.50 Ea	36.00 Ea										
O-6	A-18		<b>SENIOR ANCHOR LIGHTS</b>		17	A-18		<b>SIDE LIGHTS</b>					
O-6A			Galv	Pol Br	17A			Galv Pol Br					
O-6B		\$30.25 Ea	\$ 49.00 Ea		17B			Each Each					
O-6R		30.25 Ea	49.00 Ea		17R		\$68.00 Pr	\$107.00 Pr					
O-6G		30.25 Ea	49.00 Ea		17G		68.00 Pr	107.00 Pr					
O-6M		30.25 Ea	49.00 Ea		17RA		68.00 Pr	107.00 Pr					
O-6RA		30.25 Ea	49.00 Ea		17RB		\$36.00 Ea	\$ 56.00 Ea					
O-6GA		30.25 Ea	49.00 Ea		17GA		36.00 Ea	56.00 Ea					
O-6MA		30.25 Ea	49.00 Ea		17GB		36.00 Ea	56.00 Ea					
O-6RB		30.25 Ea	49.00 Ea										
O-6GB		30.25 Ea	49.00 Ea										
O-6MB		30.25 Ea	49.00 Ea										
4A		A-17	C/2	<b>SIDE LIGHTS</b>		18	A-18		<b>BOW LIGHTS</b>				
4B				Galv	Pol Br	18A			Galv Pol Br				
4A				\$54.00 Pr	\$ 91.00 Pr	18B			Each Each				
4B				54.00 Pr	91.00 Pr			\$34.00 Ea	\$ 54.00 Ea				
4RA				58.00 Pr	103.00 Pr			34.00 Ea	54.00 Ea				
4RB				58.00 Pr	103.00 Pr			34.00 Ea	54.00 Ea				
4RA	C/2			Galv	Pol Br	19	A-18		<b>SIDE LIGHTS</b>				
4RB				\$29.25 Ea	\$ 47.75 Ea	19A			Galv Pol Br				
4GA				29.25 Ea	47.75 Ea	19B			Each Each				
4GB				29.25 Ea	47.75 Ea	19R			\$70.00 Pr	\$116.00 Pr			
4RA				31.50 Ea	54.00 Ea	19G			70.00 Pr	116.00 Pr			
4RB				31.50 Ea	54.00 Ea	19RA			70.00 Pr	116.00 Pr			
4GA	C/3		Galv	Pol Br	19R			\$37.25 Ea	\$ 60.00 Ea				
4GB			29.25 Ea	47.75 Ea	19G			37.25 Ea	60.00 Ea				
4RA			31.50 Ea	54.00 Ea	19RA			37.25 Ea	60.00 Ea				
4RB			31.50 Ea	54.00 Ea	19RB			37.25 Ea	60.00 Ea				
4GA			31.50 Ea	54.00 Ea	19GA		37.25 Ea	60.00 Ea					
4GB			31.50 Ea	54.00 Ea	19GB		37.25 Ea	60.00 Ea					
4-RD	B-7	C/3			20	A-18		<b>BOW LIGHTS</b>					
4-GD				Galv	Pol Br		20A		Galv Pol Br				
			Each	Each	20B			Each Each					
5A	A-17	C/2	<b>BOW LIGHTS</b>		21R	B-14	#1	<b>SIDE LIGHTS</b>					
5B				Galv	Pol Br			21G		Galv Pl Br Pol Br			
5A				\$26.75 Ea	\$ 45.50 Ea			21RB		Each Each Each			
5B			26.75 Ea	45.50 Ea	21GB				\$102.00	\$152.00	\$167.00		
5MA			29.25 Ea	51.00 Ea	21RC				102.00	152.00	167.00		
5MB			29.25 Ea	51.00 Ea	21GC				102.00	152.00	167.00		
5D	B-7	C/3			21R			B-13	#2	<b>ALL-ROUND LIGHTS</b>			
				Galv	Pol Br					21G		Galv Pl Br Pol Br	
			Each	Each	21RB						Each Each Each		
			\$37.50	\$59.25	21GB						\$102.00	\$152.00	\$167.00
7A	A-17	C/2	<b>STERN LIGHTS</b>		21RC						102.00	152.00	167.00
7B				Galv	Pol Br					21GC		102.00	152.00
7A				\$26.75 Ea	\$ 45.50 Ea	21R				128.00	190.00	212.00	
7B			26.75 Ea	45.50 Ea	21G		128.00			190.00	212.00		
7MA			29.25 Ea	51.00 Ea	21RB		128.00			190.00	212.00		
7MB			29.25 Ea	51.00 Ea	21GB		128.00			190.00	212.00		
			Galv	Pol Br	21RC		128.00			190.00	212.00		
			Each	Each	21GC		128.00			190.00	212.00		

Where Standard Packaging Not Indicated, Packaged Quantity is One Unit.

# N-6

Figure	Page	Size	List Price	Std. Pkg.	Figure	Page	Size	List Price	Std. Pkg.	
24	A-19	#1	D.C. SOCKETS \$ 1.15 Ea	10	51	I-32	#2-3/16"	FAST EYE BLOCKS \$ 2.10 Ea	10	
	M-2	#2	1.85 Ea	10				#4-1/4"	2.75 Ea	10
27	D-2		SHIELDS Plain Painted	10	52	A-19		D.C. SOCKET \$ 1.15 Ea	10	
			\$ 3.00 Ea \$ 3.80 Ea							
28	D-2		\$ 3.00 Ea \$ 3.80 Ea	10						
30RB 30GB 30RC 30GC 30RB 30GB 30RC 30GC	B-5 B-5 B-12 B-12 B-5 B-5 B-12 B-12	#1 #1 #1 #1 #2 #2 #2 #2	SIDE LIGHTS Galv Pl Br Pol Br Each Each Each		56	C-11	#4 12V-8 C.P. #5-12V-1.4 C.P. #6-32V-9 C.P.	MINIATURE BAYONET BULBS \$ 2.50 Ea	10	
			\$ 96.00 \$144.00 \$160.00					1.10 Ea	10	
			96.00 144.00 160.00					1.95 Ea	10	
			96.00 144.00 160.00					\$ 5.50 Card	2 Pc	
			121.00 181.00 201.00					66.00 Box	12 Cds	
			121.00 181.00 201.00							
			121.00 181.00 201.00					CLINCH STUD \$18.65 C	100	
			121.00 181.00 201.00					CLINCH WASHER \$ 5.25 C	100	
32B 32C 32B 32C	B-5 B-12 B-5 B-12	#1 #1 #2 #2	ALL-ROUND LIGHTS Galv Pl Br Pol Br Each Each Each		63	H-17	#5-3/4" #6-1" #7-1 1/4" #8-1 1/2"	PIPE TO HOSE ADAPTER \$ 3.85 Ea		
			\$ 96.00 \$144.00 \$160.00					4.90 Ea		
			96.00 144.00 160.00					6.45 Ea		
			121.00 181.00 201.00					8.40 Ea		
33	D-2		SHIELDS \$ 3.80 Ea	10	65	H-15	#4-1/2" #5-3/4" #6-1" #7-1 1/4"	INTAKE STRAINERS \$10.60 Ea		
33 SP	D-2 & L-8		\$ 4.65 Card 27.90 Box	1 Pc 6 Cds				13.25 Ea		
34	D-2		\$ 3.80 Ea	10	66	H-16	#1 #2 #3 #4	SCOOP STRAINERS \$ 3.35 Ea	5	
34 SP	D-2 & L-8		\$ 4.65 Card 27.90 Box	1 Pc 6 Cds				7.15 Ea	5	
36	D-2		\$ 3.80 Ea	10				9.35 Ea	5	
36 SP	D-2 & L-8		\$ 4.65 Card 27.90 Box	1 Pc 6 Cds				17.25 Ea	5	
42	C-9		SPARE D.C. CONNECTOR \$ 1.85 Ea	5	70	C-11	#0 12V-6 C.P. #1 12V-12 C.P. #2 32V-12 C.P.	BULBS \$ 1.00 Ea 1.00 Ea 1.20 Ea	10 10 10	
43	I-32	#1-3/16" #3-1/4" #5-5/16" #7-3/8" #9-7/16" #11-1/2" #13-5/8" #15-3/4"	FAST EYE BLOCKS Galv Pl Br	10	70SP	C-11 & L-5	#1	\$ 1.20 Ea \$ 2.20 Ea	\$ 2.80 Card	2Pcs
			1.95 Ea 3.30 Ea					33.60 Box	12 Cds	
			2.20 Ea 5.45 Ea							
			2.90 Ea 6.55 Ea							
			3.65 Ea —							
			5.20 Ea —							
			8.50 Ea —							
			11.95 Ea —							
44 44F 44B 44FB	D-6	#1-6" #2-8" #3-10" #1-6" #2-8" #3-10" #1-6" #2-8" #3-10" #1-6" #2-8" #3-10"	SIGNAL LIGHTS Pol Br		73	H-4	#3-3/4" #3A-3/4" #4-7/8" #4A-7/8" #5-1" #6-1-1/8" #7-1 1/4" #7A-1 1/4" #8-1-3/8" #9-1 1/2" #9A-1 1/2" #10-1 3/4" #11-2"	PACKING NUTS \$ 3.60 Ea		
			\$ 87.50 Ea					4.50 Ea		
			103.50 Ea					4.50 Ea		
			165.50 Ea					4.50 Ea		
			87.50 Ea					4.50 Ea		
			103.50 Ea					5.10 Ea		
			165.50 Ea					6.90 Ea		
			87.50 Ea					6.90 Ea		
			103.50 Ea					8.95 Ea		
			165.50 Ea					9.55 Ea		
87.50 Ea	9.55 Ea									
103.50 Ea	11.40 Ea									
165.50 Ea	20.50 Ea									
87.50 Ea	21.50 Ea									
103.50 Ea										
165.50 Ea										
49	D-6		NAVY LANTERN Galv Pol Br		74	A-15		SPARE LENS \$ 1.25 Ea		
			\$42.25 Ea \$71.00 Ea							
49	D-6				75	H-17	#3-3/8" #4-1/2" #5-3/4" #6-1" #7-1 1/4" #8-1 1/2" #9-2" #10-2 1/2"	LOCK NUTS \$ .95 Ea	5	
								1.00 Ea	5	
								1.50 Ea	5	
								2.25 Ea	5	
								3.80 Ea	5	
								4.50 Ea		
								6.55 Ea		
								7.60 Ea		

Where Standard Packaging Not Indicated, Packaged Quantity Is One Unit.



Figure	Page	Size	List Price	Std. Pkg.	Figure	Page	Size	List Price	Std. Pkg.	
76	H-17	#4-1/2"	PIPE TO HOSE ADAPTERS \$ 2.75 Ea		97	A-18	STERN LIGHTS Galv Pol Br			
		#5-3/4"	3.35 Ea	\$34.00 Ea \$54.00 Ea						
		#6-1"	4.25 Ea	34.00 Ea 54.00 Ea						
		#7-1 1/4"	5.60 Ea	34.00 Ea 54.00 Ea						
		#8-1 1/2"	7.30 Ea							
#9-2"	11.00 Ea									
77	A-19	Clear	SPARE GLOBES \$ 5.85 Ea		98	A-16	C/2 C/3	BOW LIGHTS Galv Pol Br		
79	H-4	#3-3/4"	LOCK NUTS \$ 2.10 Ea		99	A-16	C/2 C/3	\$21.00 Ea \$34.00 Ea		
		#3A-3/4"	\$ 2.10 Ea	22.25 Ea 36.75 Ea						
		#4-7/8"	2.10 Ea							
		#4A-7/8"	2.10 Ea							
		#5-1"	2.40 Ea							
		#6-1-1/8"	3.00 Ea							
		#7-1 1/4"	3.00 Ea							
		#7A-1 1/4"	3.70 Ea							
		#8-1-3/8"	4.00 Ea							
		#9-1 1/2"	4.00 Ea							
		#9A-1 1/2"	4.60 Ea							
#10-1 3/4"	7.95 Ea									
#11-2"	9.35 Ea									
82	J-8	99A 99B	WINDSHIELD ADJUSTERS \$ 44.25 Pr		102	A-18	STERN LIGHTS Galv Pol Br			
			3.50 Ea				\$35.00 Ea \$ 57.00 Ea			
			22.25 Ea		102A			35.00 Ea 57.00 Ea		
					102B			35.00 Ea 57.00 Ea		
84GB	B-5	#1	ALL-ROUND LIGHTS Galv PI Br Pol Br		103	C-2,F-2	MOUNTING LEGS			
			Each Each Each				\$ 1.20 Set	5		
			\$ 96.00 \$144.00 \$160.00							
			96.00 144.00 160.00							
			96.00 144.00 160.00							
			96.00 144.00 160.00							
			121.00 181.00 201.00							
			121.00 181.00 201.00							
84RC	B-12	#1	96.00 144.00 160.00		104	C-4	SPARE KNOB			
84RB	B-5	#2	121.00 181.00 201.00				\$ .50 Ea			
84RC	B-12	#2	121.00 181.00 201.00		105	C-4	#1 #2	PUSH PULL SWITCH		
84GB	B-5	#2	121.00 181.00 201.00					\$ 2.90 Ea	10	
84MB	B-5	#2	121.00 181.00 201.00		105 SP	C-4 & L-6	#1	\$ 3.50 Ea	10	
								\$ 3.60 Card	1 Pc	
								43.20 Box	12 Cds	
85	C-2		SAFETY MAIN SWITCH \$25.50 Ea		106	A-19	SPARE GLOBE			
85 SP	C-2 & L-6		\$26.75 Card	1 Pc			\$10.50 Ea			
			80.25 Box	3 Cds			10.50 Ea			
							10.50 Ea			
86	H-16	#1-2 1/2"	ROUND STRAINERS \$ 2.00 Ea	5	109	A-16	SIDE LIGHTS			
			#2-3"	2.35 Ea			5	\$48.50 Pr		
			#3-3 1/2"	2.85 Ea			5	109R	26.00 Ea	
			#4-4"	4.00 Ea			5	109G	26.00 Ea	
			#5-5"	6.75 Ea			5			
			#6-6"	7.70 Ea						
			#7-8"	19.20 Ea						
90	J-19		STUD \$18.65 C	100	110	A-16	BOW LIGHT \$27.00 Ea			
91	A-16	C/2 C/3	SIDE LIGHTS Galv Pol Br		111	A-16	STERN LIGHT			
			\$41.75 Pr \$ 68.00 Pr				\$24.50 Ea			
			44.25 Pr 73.00 Pr				24.50 Ea			
			\$23.25 Pr \$ 36.00 Pr							
			24.50 Pr 39.00 Pr							
91R		C/2	24.50 Pr 39.00 Pr		111M					
91G		C/3	23.25 Pr 36.00 Pr							
		C/2	24.50 Pr 39.00 Pr							
		C/3	24.50 Pr 39.00 Pr							
92	A-16		MOUNTING BRACKET \$ 2.35 Ea \$ 3.50 Ea		112	A-8,B-7	ALL-ROUND LIGHTS PI Br Chrome			
94	D-8		LAMP CHIMNEY \$ 2.25 Ea				\$34.00 Ea \$ 70.00 Ea			
							34.00 Ea 70.00 Ea			
							34.00 Ea 70.00 Ea			
96	C-2		MAIN SWITCH \$ 25.50 Ea		112M					
					112R					
					112G					
					113	G-6,7	SPARE EYE BOLT			
							\$ 3.50 Ea			
					114	J-19	FASTENERS			
							\$25.75 C	100		
					115	J-19	28.00 C	100		
					116	J-19	25.75 C	100		

Where Standard Packaging Not Indicated, Packaged Quantity Is One Unit.

# N-8

Figure	Page	Size	List Price	Std. Pkg.	Figure	Page	Size	List Price	Std. Pkg.
117	CONT'D J-19		<b>FASTENERS</b> \$ 28.00 C	100	132	D-5		<b>SPARE LENS</b> \$ 5.55 Ea	
118	J-19		7.00 C	100	134	C-10		<b>INDICATOR LIGHTS</b> \$10.00 Ea	10
119	I-11	4" 5" 6" 8"	<b>STERN CHOCKS</b> \$ 8.00 Ea 10.50 Ea 12.00 Ea 20.75 Ea	5 5	135	C-10		14.00 Ea	10
119SP	I-11 & L-15	4"	\$ 8.85 Card 53.10 Box	1 Pc 6 Cds	136	C-10		3.20 Ea	10
120	J-12	#1-4" #2-6" #3-8"	<b>STRAP HINGES</b> Burn Br Chrome \$ 8.50 Pr \$12.25 Pr 9.65 Pr 13.15 Pr 13.75 Pr 20.25 Pr	5 Pr 5 Pr	137	C-10		3.80 Ea	10
121	C-7	#1-1/8" #2-3/16" #3-1/4" #4-5/16" #5-3/8" #6-7/16" #7-1/2" #8-5/8" #9-3/4"	<b>BRASS CABLE STRAPS</b> \$ 5.95 C 6.35 C 7.00 C 7.00 C 7.90 C 8.75 C 9.00 C 11.00 C 12.25 C	100 100 100 100 100 100 100 100 100	138	A-20	C/2 C/3	<b>ELECTRIC ADAPTER</b> \$ 5.00 Ea 5.00 Ea	
122	J-12		<b>STRAP HINGE</b> \$ 14.85 Pr		139	C-10		<b>PANEL LIGHT</b> \$ 9.35 Ea	10
123	G-6		<b>SPARE EYE BOLT</b> \$ 5.25 Ea		140	D-5		<b>UTILITY LIGHT</b> \$ 2.90 Ea	10
124	H-20	99A 99B	<b>DRAIN PLUG</b> \$ 12.70 Ea 4.65 Ea 4.65 Ea	5	140SP	D-5 & L-5		\$ 3.50 Card 35.00 Box	1 Pc 10 Cds
127	G-6		<b>SPARE WALL PLATES</b> Pol Br Chrome \$ 7.00 Ea \$ 8.15 Ea		141	D-8	#1 #2	<b>OIL CABIN LIGHTS</b> Pol Br Chrome \$45.00 Ea \$50.25 Ea 47.70 Ea 51.75 Ea	
128	D-8	#0 #1 #2 #0-99A #1-99A #2-99A	<b>SMOKE BELLS</b> Pol Br Chrome \$10.00 Ea \$13.00 Ea 10.00 Ea 13.00 Ea 10.00 Ea 13.00 Ea 5.00 Ea 6.30 Ea 5.00 Ea 6.30 Ea 5.00 Ea 6.30 Ea		142	H-19	#1 #2 #1-99A #2-99A #1-99B #2-99B	<b>COCKPIT SCUPPERS</b> Pl Br Chrome \$16.90 Ea \$21.25 Ea 24.00 Ea 29.00 Ea 3.50 Ea 5.25 Ea \$ 5.85 Ea \$ 7.60 Ea .60 Ea — .70 Ea —	
129R	B-14	#1	<b>ALL-ROUND LIGHTS</b> Galv Pl Br Pol Br Each Each Each \$102.00 \$152.00 \$167.00		143	B-16		<b>MOUNTING BRACKET</b> \$ 9.90 Ea	
129G	B-14	#1	102.00 152.00 167.00		144	G-6		<b>SPARE CLAPPER</b> Pol Br Chrome \$ 9.35 Ea \$ 10.50 Ea	
129M	B-14	#1	102.00 152.00 167.00		148	I-22	99A 99B	<b>TABLE BRACKETS</b> \$ 9.35 Set 4.65 Pr 4.65 Pr	5 Sets
129R	B-14	#2	128.00 190.00 212.00		149	J-15		<b>"PULL OUT" HINGE</b> \$13.15 Ea	2
129G	B-14	#2	128.00 190.00 212.00		150	G-6	8" 10" 12"	<b>FOG BELLS</b> Pol Br Chrome \$117.00 Ea \$126.00 Ea 242.00 Ea 279.00 Ea 368.00 Ea 410.00 Ea	
129M	B-14	#2	128.00 190.00 212.00		150		99A-10" 99A-12"	<b>SPARE ARMS</b> Pol Br Chrome \$24.50 Ea \$28.00 Ea 24.50 Ea 28.00 Ea	
129RB	B-6	#1	102.00 152.00 167.00		150		99B-10" 99B-12"	<b>SPARE WALL PLATES</b> Pol Br Chrome \$13.40 Ea \$15.15 Ea 13.40 Ea 15.15 Ea	
129GB	B-6	#1	102.00 152.00 167.00		150		99C	<b>SPARE CLAPPERS</b> Pol Br Chrome \$23.25 Ea \$29.50 Ea	
129MB	B-6	#1	102.00 152.00 167.00		150		99D	<b>SPARE EYE BOLTS</b> Pol Br \$ 5.85 Ea	
129RC	B-13	#1	102.00 152.00 167.00		152	J-15		<b>"PULL OUT" HINGES</b> \$13.15 Ea	2
129RB	B-6	#2	128.00 190.00 212.00		153	G-6,7		<b>SPARE CLAPPER</b> \$ 3.50 Ea	
129GB	B-6	#2	128.00 190.00 212.00		154	I-27	#20 #28	<b>SHEAVES</b> \$ .40 Ea .65 Ea	% 10 % 10
129MB	B-6	#2	128.00 190.00 212.00						
129RC	B-13	#2	128.00 190.00 212.00						
131	A-20		<b>MOUNTING BRACKET</b> Galv Brass \$ 2.90 Ea \$ 4.10 Ea						

Where Standard Packaging Not Indicated, Packaged Quantity Is One Unit.

Figure	Page	Size	List Price	Std. Pkg.	Figure	Page	Size	List Price	Std. Pkg.
155	J-9	HATCH FASTNERS \$13.15 Ea		5			OIL CABIN LIGHT Pol Br Chrome \$38.00 Ea \$43.25 Ea		
157	G-3	ROUND PORTLIGHTS			168	D-8			
		4"	\$42.00 Ea				SPARE BELL ARM Pol Br Chrome \$18.65 Ea \$22.25 Ea		
		5"	52.00 Ea		171	G-6			
		6"	58.00 Ea				SPARE CLAPPER & EYE BOLT Pol Br Chrome \$45.00 Ea \$50.00 Ea		
		8"	85.00 Ea		172	G-6			
		4"-99A	9.35 Ea		173	D-8	SPARE BURNER \$ 4.40 Ea		
		5"-99A	11.65 Ea		178	J-6	FRICTION CATCH \$ .75 Ea		10
		6"-99A	14.00 Ea		180	I-22	#1 #2	RAIL HINGE \$23.00 Ea 24.50 Ea	
		8"-99A	16.30 Ea		184	C-10	DASHBOARD LAMP \$11.40 Ea		10
158	G-6	FOG BELLS Pol Br Chrome			185	I-22	#1 #2	RAIL LATCH \$21.50 Ea 23.25 Ea	
		12"	\$298.00 Ea \$315.00 Ea		190	G-4	LEAD LINES		
		14"	391.00 Ea 420.00 Ea				7 Fathom	\$23.25 Ea	
158		SPARE ARMS & WALL PLATES Pol Br Chrome					10 Fathom	30.00 Ea	
		99A-12"	\$24.50 Ea \$28.00 Ea				15 Fathom	40.25 Ea	
		99A-14"	24.50 Ea 28.00 Ea				20 Fathom	48.50 Ea	
159	G-6	FOG BELLS					25 Fathom	58.00 Ea	
		6"	PI Br Pol Br Chrome				30 Fathom	69.00 Ea	
		8"	Each Each Each				BLOWER SWITCH \$25.50 Ea		
		99A	\$16.75 \$19.60 \$22.75		193	F-2			
		99B	28.00 33.75 36.00		194	I-32	#1-3/16" #2-1/4" #3-5/16-3/8"	WIRE ROPE PULLEYS \$ 9.60 Ea 10.70 Ea 16.50 Ea	
159SP	G-7 & L-12	6"	Chrome	1 Pc 2 Cds	196	C-7	#1-3/16" #2-1/4" #3-5/16-3/8" #4-3/8" #5-1/2" #6-5/8" #7-3/4"	PLASTIC CABLE STRAPS \$ 5.85 C 6.15 C 6.35 C 7.00 C 7.30 C 11.65 C 12.70 C	100 100 100 100 100 100 100
160	I-11	#1-4 1/2" #2-5-1/8" #3-7 1/4"	BOW CHOCKS \$18.25 Pr 27.00 Pr 50.00 Pr	5 Pr 5 Pr	197	J-12	#1-4" #2-6" #3-8"	"T" HINGES Burn Chrome \$ 9.70 Pr \$19.60 Pr 11.65 Pr 22.25 Pr 19.25 Pr 32.50 Pr	5 Pr 1 Pr 1 Pr
161	I-11	#11-4" #12-5 3/4" #13-7"	STERN CHOCKS \$ 9.65 Ea 14.00 Ea 25.25 Ea	5 5	201	M-2	SPARE GLOBE \$ 1.95 Ea		
162	G-7	FOG HORN \$ 4.95 Ea		10	211	J-15	#2-1 1/4"x6' #4-1 1/2"x6' #6-2"x6'	CONTINUOUS HINGE \$22.75 Ea 24.50 Ea 29.25 Ea	10 10 10
162SP	L-12	6.45 Card 38.70 Box		1 Pc 6 Cds	212	J-15	#2-1 1/4"x6' #4-1 1/2"x6'	\$17.50 Ea 18.65 Ea	10 10
163	C-7	#1-3/16" #2-1/4" #3-5/16" #4-3/8" #5-1/2" #6-5/8"	ALUMINUM SUPPORT CLIPS \$15.75 C 15.75 C 15.75 C 18.65 C 20.50 C 22.75 C	100 100 100 100 100 100	217	D-2	CABIN FIXTURE Chrome \$ 4.90 Ea		
164	C-7	#1-3/16" #2-1/4" #3-5/16" #4-3/8" #5-1/2"	\$26.25 C 26.25 C 26.25 C 26.25 C 28.00 C	100 100 100 100 100	217SP	D-2 & L-5	\$ 5.85 Card 35.10 Box		1 Pc 6 Cds
165	C-7	#3-5/16" #4-3/8" #5-1/2"	\$36.00 C 38.50 C 43.75 Ea	100 100 100	218	I-22	#1-3/4" #2-1" #3-1 1/4"	FLAG POLE SOCKETS \$ 5.00 Ea 6.75 Ea 7.70 Ea	
166	G-5,7	WALL PLATE PI Br Pol Br Chrome \$2.35 Ea \$2.90 Ea \$3.50 Ea							
167	G-7	PLASTIC WHISTLE \$ 1.10 Ea		10					
167SP	G-7 & L-12	\$ 1.70 Card 20.40 Box		1 Pc 12 Cds					

Where Standard Packaging Not Indicated, Packaged Quantity Is One Unit.

# N-10

Figure	Page	Size	List Price	Std. Pkg.	Figure	Page	Size	List Price	Std. Pkg.
219	CONT'D I-22	#1-3/4" #2-1" #3-1 1/4" #4-1 1/2"	FLAG POLE SOCKETS		248SP	A-19 & L-8	CONT'D	2.60 Card	1 Pc
			\$ 5.85 Ea	26.00 Box				10 Cds	
			7.70 Ea	\$ 3.70 Ea					
			8.75 Ea	4.50 Ea					
12.00 Ea	SPARE LENS								
220	I-22	#1-3/4" #2-1" #3-1 1/4"	\$ 7.70 Ea	251R	A-4		\$ 1.50 Ea		
			9.70 Ea				251G		1.50 Ea
			11.25 Ea				ELECTROLYSIS COLLARS		
221	I-22	#1-3/4" #2-1" #3-1 1/4"	\$ 8.15 Ea	252	H-10	#3-3/4" #4-7/8" #5-1" #6-1 1/8" #7-1 1/4" #8-1 1/2" #9-1 1/2" #10-1 3/4" #11-2"	\$ 4.20 Ea	10	
			10.00 Ea				4.20 Ea		
			11.65 Ea				5.50 Ea		
222	A-8		SPARE SOCKETS		253	H-10	#11-2" #12-2 1/4" #13-2 1/2" #14-3" #15-3 1/2" #16-4"	\$ 1.90 Ea	10
			\$ 1.50 Ea	8.25 Ea					
223	D-2		SPARE RECEPTACLE		254	H-11	#3 #4 #5 #5A	\$ 3.10 Ea	5
			\$ 1.50 Ea	8.25 Ea					
224	I-25	#4 #5	BOAT HOOKS		255	C-5		\$ 4.10 Ea	10
			\$ 6.85 Ea	%5				255SP	
225	D-2		SPARE CHIMNEY		256	A-19	C/2 C/3 C/3	28.50 Box	6 Cds
			\$ .70 Ea	%5				256M	
230	D-8		OIL BURNER		256R		#1 #2	25.75 Ea	10
			Brass Chrome					256M	
231	D-8		SPARE LENS		257	D-4	3" 4" 5" 6"	\$ 3.90 Ea	1 Pc
			\$ 4.00 Ea	10				257	
232R 232G	A-4		SPARE LENS		258	J-15	#2-1 1/4"x6' #4-1 1/2"x6'	\$ 10.50 Ea	10
			\$ 1.55 Ea	10				258	
233	I-18		OAR LEATHERS & BUTTONS		259AR	A-4		\$ 1.50 Ea	10
			\$ 3.80 Pr	5 Pr				259AG	
234	A-7		HALYARD EYE		259R	A-19	C/2 C/2	\$ 9.35 Ea	10
			\$ .30 Ea	10				259G	
235	A-7		HALYARD EYE						
			\$ 1.15 Ea	10					
236	I-13	#1-7/16"x3" #3-7/16"x3" #4-1/2"x3 1/2"	TRANSOM EYES						
			\$ 6.35 Ea	10					
			7.35 Ea	5					
			15.50 Ea	5					
237	I-12	#1-1/16x3 1/4" #2-7/16"x6" #3-7/16"x3" #4-1/2"x3"	BOW EYES						
			\$ 5.85 Ea	10					
			6.85 Ea	10					
			6.75 Ea	10					
237 SP	I-12 & L-16	#1	\$ 6.90 Card	1 Pc					
			41.40 Box		6 Cds				
241	H-11		ELECTROLYSIS ELIMINATOR						
			\$12.95 Ea	5					
242	B-16,D-6		OIL BURNER						
			Brass Chrome						
243	J-15	#2-1 1/4"x6' #4-1 1/2"x6'	HATCH TRIM						
			\$13.40 Ea	10					
244	H-10	#1-3 1/2" #2-5 1/4"	ELECTROLYSIS ELIMINATORS						
			\$ 2.10 Ea	10					
246	A-20,D-6		OIL BURNER						
			\$ 3.80 Ea	10					
247	H-11		ELECTROLYSIS ELIMINATORS						
			\$ 3.65 Ea	10					
248	A-19	Clear	SPARE GLOBE						
			\$ 1.95 Ea						

Where Standard Packaging Not Indicated, Packaged Quantity Is One Unit.

Figure	Page	Size	List Price	Std. Pkg.	Figure	Page	Size	List Price	Std. Pkg.
259R	CONT'D	C/3	FRESNEL LENSES			CONT'D	#2	2.10 Ea	
259G		C/3	10.50 Ea				#3	2.40 Ea	
259R	B-16	#1	10.50 Ea				#4	2.40 Ea	
259G		#1	12.70 Ea		278	A-11, 14, 15	SPARE LENS \$ .95 Ea		
259R		#2	12.70 Ea		279	I-32	#10- $\frac{7}{16}$ "	WIRE ROPE PULLEYS \$ 8.85 Ea	
259G		#2	16.30 Ea				#20- $\frac{1}{4}$ "	10.55 Ea	
261	A-19	Jr	16.30 Ea				#30- $\frac{7}{16}$ - $\frac{3}{8}$ "	16.00 Ea	
261R		Jr	\$10.50 Ea		280	A-9	SPREADER LIGHT \$25.50 Ea		
261G		Jr	10.50 Ea		281	A-12, 13	SPARE LENSES \$ 1.00 Ea		
261M		Jr	10.50 Ea		281R		1.00 Ea		
261		Sr	\$12.25 Ea		281G		1.00 Ea		
261R		Sr	12.25 Ea		282	B-16, #1 & D-6 #2	ELECTRIC ADAPTORS \$12.35 Ea		
261G		Sr	12.25 Ea				14.55 Ea		
261M		Sr	12.25 Ea		283R	A-3,12	SPARE LENSES \$ 1.00 Ea		
261F	D-7	Jr	\$10.50 Ea		283G	M-2	1.00 Ea		
		Sr	12.25 Ea				SPARE LENS & GASKET \$ 1.15 Ea		
		#1	21.00 Ea		284	A-9,15	OIL FOUNT \$ 6.75 Ea		
		#2	21.00 Ea				\$ 7.30 Ea		
		#2	35.00 Ea		286	A-20, D-6	ELECTRIC ADAPTERS \$15.20 Ea		
261	B-16	#1	21.00 Ea				15.50 Ea		
261R		#1	21.00 Ea		288	B-16 #1 & D-6 #2	\$ 9.35 Ea		
261G		#1	21.00 Ea				9.35 Ea		
261M		#1	21.00 Ea		291	A-17, 20	\$ 9.35 Ea		
261		#2	35.00 Ea				\$ 9.35 Ea		
261R		#2	35.00 Ea		292	A-20, D-6	\$10.10 Ea		
261G		#2	35.00 Ea		293	A-20	ELECTRIC ADAPTER \$12.00 Ea		
261M		#2	35.00 Ea		294	B-7 #3	SPARE LENSES \$ 1.00 Ea		
262	D-6		SPARE GLOBE \$ 8.75 Ea		296R	A-5	1.00 Ea		
263	H-20		DRAIN PLUG \$ 7.90 Ea	5	296G		FUEL FILTERS \$43.25 Ea		
264	D-6,7	1-6" 2-8" 3-10"	SPARE GLOBES Clr, Frosted \$14.00 Ea 18.00 Ea 28.00 Ea		299	H-12	#1- $\frac{1}{4}$ "- $\frac{3}{8}$ " #1 $\frac{1}{2}$ "- $\frac{3}{8}$ "- $\frac{1}{2}$ "	65.00 Ea	
265	A-9	99A	SPREADER LIGHT \$10.50 Ea 1.50 Ea		300	D-4	#0-3" #1-4" #2-5"	DOME LIGHTS \$ 8.75 Ea 9.90 Ea 11.00 Ea	
266	H-20		DRAIN PLUG \$ 7.90 Ea	5	300SP	D-4 & L-5	#1-3"	\$10.75 Card 32.25 Box	1 Pc 3 Cds
267	B-16		CHIMNEY \$ 4.50 Ea	10	301	H-16	#4- $\frac{1}{2}$ " #4A- $\frac{3}{8}$ " #5- $\frac{3}{4}$ " #6-1" #8-1 $\frac{1}{2}$ "	THRU-HULL CONNECTORS \$ 2.05 Ea 2.05 Ea 2.50 Ea 3.65 Ea 4.50 Ea	10 10 10 5 5
268	I-9	12V	SPREADER LIGHT \$ 22.50 Ea		301SP	H-16	#4- $\frac{1}{2}$ "	\$ 2.95 Card 29.50 Box	1 Pc 10 Cds
269	A-19	C/2	FRESNEL LENSES \$ 9.35 Ea			& L-8	#4A- $\frac{3}{8}$ "	\$ 2.95 Card 29.50 Box	1 Pc 10 Cds
269M		C/2	9.35 Ea				#5- $\frac{3}{4}$ "	3.55 Card	1 Pc
269		C/3	10.50 Ea				#6-1"	28.40 Box	8 Cds
269M		C/3	10.50 Ea				#8-1 $\frac{1}{2}$ "	4.90 Card	1 Pc
269	B-16	#1	\$15.15 Ea					29.40 Box	6 Cds
269R		#1	15.15 Ea					6.00 Card	1 Pc
269M		#1	15.15 Ea					36.00 Box	6 Cds
269		#2	22.25 Ea						
269R		#2	22.25 Ea						
269M		#2	22.25 Ea						
270	B-16 With Cap		MOGUL SOCKET \$ 8.15 Ea						
271	J-14		HINGE \$ 3.70 Pr	10 Pr					
274	A-20, D-6		ELECTRIC ADAPTOR \$ 10.15 Ea						
275	C-9		HORN BUTTON \$ 2.55 Ea	10					
276	A-19	#0	D.C. SOCKETS \$ 2.10 Ea						

Where Standard Packaging Not Indicated, Packaged Quantity Is One Unit.

# N-12

Figure	Page	Size	List Price	Std. Pkg.	Figure	Page	Size	List Price	Std. Pkg.
302	A-20, D-8	#0-1/2"	OIL WICKS \$ .30 Ea	10	317	G-3	4"	ROUND PORT LIGHTS \$40.00 Ea	
302	B-16, D-8	#2-7/8"	\$ .30 Ea	10			5"	46.75 Ea	
304	C-5		STARTER SWITCH \$10.25 Ea	5			6"	57.00 Ea	
305	E-7		SEARCH LIGHTS Pol Satin Pol Br Chrome Chrome Each Each Each \$254.00 \$254.00 \$286.00		318	D-4	99A	DOME LIGHT \$30.00 Ea 3.25 Ea	
305A			265.00 265.00 297.00		320	H-4	#3-3/4"	REGULAR STUFFING BOXES \$14.60 Ea	
305B			275.00 275.00 308.00				#4-7/8"	17.25 Ea	
305C			286.00 286.00 319.00				#5-1"	18.65 Ea	
306	C-5	99A	STARTER SWITCH \$ 4.80 Ea 1.50 Ea	10			#6-1 1/8"	23.75 Ea	
307	I-29	00 0 1	CAULKING IRONS \$ 6.80 Ea 6.80 Ea 7.25 Ea	10 10 10			#7-1 1/4"	28.25 Ea	
308	D-4	#0-3" #1-4" #2-5"	DOME LIGHTS \$ 9.00 Ea 10.25 Ea 11.40 Ea				#8-1 1/8"	35.50 Ea	
309	A-8		MAST LIGHTS Pl Br Chrome \$28.00 Ea \$52.00 Ea		321	C-4		PUSH-PULL SWITCH \$ 4.40 Ea	10
309M	B-7		28.00 Ea 52.00 Ea		322	H-15	#3-3/8"	THRU-HULL CONNECTIONS \$ 5.00 Ea	
309R			28.00 Ea 52.00 Ea				#4-1/2"	5.95 Ea	
309G			28.00 Ea 52.00 Ea				#5-3/4"	7.65 Ea	
310	C-5		STARTER SWITCH \$ 9.80 Ea	10			#6-1"	11.30 Ea	
311	H-16		THRU-HULL CONNECTION \$ 6.00 Ea				#7-1 1/4"	17.25 Ea	
312	D-8		OIL WALL LAMP \$27.00 Ea				#8-1 1/2"	21.50 Ea	
313	E-7		SEARCH LIGHTS Pol Satin Pol Br Chrome Chrome Each Each Each \$259.00 \$259.00 \$292.00				#9-2"	31.25 Ea	
313A			270.00 270.00 302.00		324	H-12	#1 #1 1/2	CLAMSHELL VENT \$ 1.40 Ea 1.75 Ea	
313B			280.00 280.00 313.00		325	I-25	99A 99B	AXE BRACKETS \$ 3.80 Set 2.65 Ea 1.50 Ea	10 Sets
313C			292.00 292.00 324.00		326	H-18	99A	OILERS \$ 3.30 Ea 1.00 Ea	10
314	I-28	#1-3/16" #2-1/4" #3-5/16" #4-3/8" #5-7/16" #6-1/2" #7-5/8" #8-3/4"	ANCHOR SHACKLES Galv \$ 1.55 Ea 1.65 Ea 1.80 Ea 2.10 Ea 2.75 Ea 3.70 Ea 5.45 Ea 7.40 Ea	10 10 10 10 10 10 5 5	327	H-12	#1 #1-1/2	SPARE ELEMENTS \$ 2.90 Ea 4.95 Ea	
315	F-4	#1 #2	CLAMSHELL VENTS \$ 1.00 Ea 1.25 Ea	10 10	329	A-9		MEAL & ABSENT LIGHT \$49.50 Ea	
315SP	F-4 & L-8	#2	\$ 2.00 Card 24.00 Box	1 Pc 12 Cds	330	F-6	#1 #2	LOCKER VENTS \$ 1.00 Ea 1.50 Ea	10 10
316	C-5	#1 #2	IGNITION SWITCHES \$ 5.85 Ea 7.20 Ea	10 10	330SP	F-6 & L-9	#2	\$ 2.35 Card 28.20 Box	1 Pc 12 Cds
316SP	C-5 & L-6	#1	IGNITION SWITCH \$ 6.50 Card 39.00 Box	1 Pc 6 Cds	331	H-15	#4-1/2" #5-3/4" #6-1" #7-1 1/4"	THRU-HULL CONNECTORS \$10.50 Ea 11.65 Ea 14.60 Ea 17.80 Ea	
					332	H-18	#5-3/4" #6-1"	WATER OUTLETS Pl Br Chrome \$12.25 Ea \$16.00 Ea 15.50 Ea 19.25 Ea	
					333	I-28	#1-1/8" #2-3/16" #3-1/4" #4-7/16" #5-3/8" #6-1/2" #7-3/8"	WIRE ROPE CLIPS \$ .50 Ea .55 Ea .65 Ea .70 Ea .95 Ea 1.35 Ea 1.75 Ea	25 25 25 10 10 5 5

Where Standard Packaging Not Indicated, Packaged Quantity Is One Unit.

Figure	Page	Size	List Price	Std. Pkg.	Figure	Page	Size	List Price	Std. Pkg.																
334	F-7	#2	LOUVER VENTS \$ 2.90 Ea	10	346	A-19& B-16& D-6	#1	SPARE MEDIUM SCREW SOCKETS \$ 1.20 Ea	5																
		#2A	3.20 Ea	10			#2	1.20 Ea	5																
		#4	3.80 Ea	10			348	H-15	#15-3/4" #6-1" #7-1 1/4" #8-1 1/2" #9-2" #10-2 1/2"	THRU-HULL CONNECTIONS \$13.90 Ea															
		#4A	4.10 Ea	10						15.60 Ea															
		#6	5.25 Ea	10						21.50 Ea															
		#6A	5.55 Ea	10						23.75 Ea															
			32.50 Ea																						
			49.50 Ea																						
335	F-7	#3	\$ 3.50 Ea	10	349	G-7		WHISTLE \$ 1.00 Ea	10																
		#3A	3.80 Ea	10			350	H-16	#4-5/8" #5-3/4" #6-1" #7-1 1/4" #8-1/2"	THRU-HULL CONNECTIONS PI Br Chrome															
		#6	4.65 Ea	10						\$ 6.55 Ea \$ 8.60 Ea															
		#6A	5.25 Ea	10						7.35 Ea 10.00 Ea															
		#9	6.15 Ea	10						11.00 Ea 13.40 Ea															
		#9A	6.35 Ea	10						17.25 Ea 19.80 Ea															
			18.65 Ea 22.00 Ea																						
336	F-7	#4	\$ 3.80 Ea	10	351	I-17		BOARDING STEP PI Br Chrome \$11.50 Ea \$15.75 Ea																	
		#4A	4.40 Ea	10			352	H-9		BOWDEN CASING CLAMP \$ 2.80 Ea	10														
		#5	4.65 Ea	10					353	H-9	#1-Casing #2-Wire	BOWDEN WIRE & CASING \$55.00 Lg. 7.00 Lg.													
		#5A	5.25 Ea	10								354	E-7		SPARE BEZEL W/GLASS Pol Satin Pol Br Chrome Chrome Each Each Each										
		#6	5.25 Ea	10										\$ 21.60 \$ 21.60 \$ 27.00											
		#6A	5.85 Ea	10										355	E-7		SPARE REAR COVER Pol Satin Pol Br Chrome Chrome Each Each Each								
			\$ 21.60 \$ 21.60 \$ 27.00																						
337	C-11	#4-6V-6 C.P.	DOUBLE CONTACT BULBS \$ .80 Ea	10	357	G-5		DRAIN FITTING \$11.00 Ea																	
		#11-12V-6 C.P.	.85 Ea	10			358	I-31		TILLER ROPE CLAMP Nat Chrome \$ 1.15 Ea \$ 1.35 Ea	20														
		#12-12V-15 C.P.	.95 Ea	10					360	J-8	99A 99B	WINDSHIELD ADJUSTER \$31.75 Ea 4.10 Ea 11.00 Ea													
		#13-12V-21 C.P.	1.10 Ea	10								361	H-15			#4-1/2" #5-3/4" #6-1" #7-1 1/4"	THRU-HULL CONNECTIONS \$12.55 Ea 13.15 Ea 16.30 Ea 18.95 Ea								
		#14-12V-32 C.P.	3.10 Ea	10										362	A-8			MAST LIGHT Plain Chrome \$16.65 Ea \$19.55 Ea							
		#18-32V-9 C.P.	3.75 Ea	10													363	H-20	#2 #3	GARBOARD DRAIN PLUGS \$13.25 Ea 13.25 Ea	5 5				
		#19-32V-15 C.P.	4.40 Ea	10																364	C-4		PUSH-PULL SWITCH \$ 4.00 Ea	10	
		#20-32V-21 C.P.	6.45 Ea	10																					
		#21-32V-32 C.P.	5.80 Ea	10																					
		#23-120V-15W	1.85 Ea	10																					
		339 339SP	F-4 F-4 & L-8									CLAMSHELL VENTS \$ 6.15 Ea	5												
												7.40 Card	1 Pc												
	44.40 Box			6 Cds																					
340	C-11           B-3,5, 6   B-4, 5, 6, 8	#5-12V-15W Frd	MEDIUM SCREW BASE BULBS \$ 2.85 Ea	6																					
		#6-12V-25W Frd	2.75 Ea	6																					
		#7-12V-50W Frd	3.00 Ea	6																					
		#11-32V-15W Frd	2.40 Ea	6																					
		#12-32V-25W Frd	2.40 Ea	2																					
		#13-32V-50W Frd	3.50 Ea	2																					
		#17-120V-60W Clr	1.50 Ea	2																					
		#19-120V-100W Clr	1.50 Ea	2																					
		#20-120V-15W Clr	2.50 Ea																						
		#21-120V-25W Clr	2.50 Ea																						
		#22-120V-40W Clr	2.50 Ea																						
		#23-120V-60W Clr	6.50 Ea																						
		#24-120V-25W Frd	1.85 Ea																						
		#25-120V-40W Frd	2.50 Ea																						
#26-120V-60W Frd	7.25 Ea																								
341	B-16	#1	ELECTRIC SOCKET SUPPORTS \$ 3.50 Ea																						
		#1-1/2	3.80 Ea																						
		#2	4.10 Ea																						
		#3	4.40 Ea																						
343	I-22	3/4"	FLAG POLE SOCKET \$ 2.65 Ea	%5																					
344	I-17	99A	FOLDING STEPS PI Br Chrome \$10.50 Ea \$22.50 Ea																						
			1.15 Ea																						
345	H-11		ELECTROLYSIS ELIMINATOR \$ 9.10 Ea	5																					

Where Standard Packaging Not Indicated, Packaged Quantity Is One Unit.

# N-14

Figure	Page	Size	List Price	Std. Pkg.	Figure	Page	Size	List Price	Std. Pkg.
369	B-16		MEDIUM SCREW SOCKET \$ 3.40 Ea	5	403B	CONT'D	#3	98.00 Ea	
					403C	B-8	#3	98.00 Ea	
370	H-20		SPARE PLUGS \$ 7.00 Ea		403RB	B-8	#2	74.00 Ea	
					403GB		#2	74.00 Ea	
371	A-8		MAST LIGHT Plain Chrome \$14.85 Ea \$17.80 Ea		403MB		#2	74.00 Ea	
372	D-7		SPARE SOCKETS \$ 1.75 Ea		403RB		#3	109.00 Ea	
373	B-7	#2-12V-.55 Amp #3-12V-.77 Amp #5-12V-2.03 Amp	SINGLE CONTACT BULBS \$ 7.00 Ea 7.00 Ea 7.75 Ea		403GB	B-8	#3	SIGNAL LIGHTS \$109.00 Ea	
					403MB	B-8	#3	109.00 Ea	
380	I-20	Ends	GRAB RAIL POST \$11.65 Ea		403RC	B-15	#2	74.00 Ea	
380A		Centers	11.65 Ea		403GC		#2	74.00 Ea	
					403MC		#2	74.00 Ea	
381	C-4		PUSH-PULL SWITCH \$ 3.85 Ea	10	403RC		#3	109.00 Ea	
386	H-19		BOAT DRAINER \$12.70 Ea		403GC		#3	109.00 Ea	
387	C-4		BOOT & NUT ASSEMBLY \$ 1.60 Ea	5	403MC		#3	109.00 Ea	
391	G-5		ROUND STAINLESS STEEL SINK \$32.00 Ea		404	K-7	#1 #2 #1-99A #2-99A	FISHING ROD HOLDERS \$16.50 Ea 22.00 Ea 5.50 Ea 7.00 Ea	
392	G-5	#1 #2	RECTANGULAR STAINLESS STEEL SINK \$58.00 Ea 90.00 Ea		405	C-7	#1-D.C. to Med. Screw #2-Med. Screw to D.C. #3-Mogul to Med. Screw	ELECTRIC ADAPTER \$ 2.55 Ea 3.20 Ea 3.20 Ea	5 5 5
395	J-18	#1 #3 #4 #5 #6 #8 #9 #10 #11	CONVERTIBLE TOP FITTINGS \$ 2.00 Ea 1.85 Ea 1.50 Ea 1.50 Ea 2.65 Ea 1.65 Ea 2.90 Ea 5.25 Ea 4.10 Ea	10 10 10 10 10 10 10 10 10	407	H-10	#2-2 7/8" #2A-3 3/4" #3-5"	ELECTROLYSIS ELIMINATORS \$ 4.70 Set 7.80 Set 12.65 Set	10 5 5
395SP	J-18 & L-23	#1 #3 #6	\$ 4.75 Card 28.50 Box \$ 4.50 Card 27.00 Box \$ 5.95 Card 35.70 Box	2 Pc 6 Cds 2 Pc 6 Cds 2 Pc 6 Cds	408	K-4,5	#1 #2 #3	SPARE HOLDING BRACKET \$21.00 Ea 39.20 Ea 39.20 Ea	
396	I-28	#1-1/8" #2-3/32" #3-3/16" #4-1/4" #5-7/16"	PETITE TURNBUCKLES \$ 3.50 Ea 4.10 Ea 4.65 Ea 5.85 Ea 6.75 Ea	5 5 5 5 5	409	K-4		SPARE STOP COLLAR \$ 7.25 Ea	
398	I-28	#4-1/4" #5-7/16"	\$ 6.00 Ea 8.00 Ea	5 5	410	K-4,5	#1 #2 #3	SPARE LAY DOWN HOOKS \$ 6.60 Ea 11.90 Ea 11.90 Ea	
400	K-4	#4-4 ft. #6-6 ft. #8-8 ft.	OUTRIGGER POLE HOLDERS \$530.00 Pr 560.00 Pr 600.00 Pr		411	I-29		SAIL MAKERS PALM \$ 4.40 Ea	12
403B	B-8	#2	ALL-ROUND LIGHTS \$70.00 Ea		412B	B-8		ALL-ROUND LIGHTS \$121.00 Ea 128.00 Ea 128.00 Ea 128.00 Ea .60 Ea	
403C	B-15	#2	70.00 Ea		412RB				
					412GB				
					412MB				
					99A				
					413	I-20	Ends	GRAB RAIL POSTS \$11.65 Ea	
					413A		Centers	9.65 Ea	
					414	H-20	#1-1"x2 1/2" #2-1"x3 1/4"	TRANSOM DRAIN PLUGS \$ 3.80 Ea 4.40 Ea	10 10
							99A #1-99B #2-99B	2.90 Ea 1.15 Ea 1.50 Ea	
					414SP	H-20 & L-8	#1	\$ 4.75 Card 57.00 Box	1 Pc 12 Cds

Where Standard Packaging Not Indicated, Packaged Quantity Is One Unit.



Figure	Page	Size	List Price	Std. Pkg.	Figure	Page	Size	List Price	Std. Pkg.
415	K-5	#1 #2 #3	SPARE STOP COLLARS \$ 6.00 Ea 15.50 Ea 15.50 Ea		444	K-6	#1 #2	OUTRIGGER POLE HOLDERS \$ 50.00 Pr 100.00 Pr	
417	I-13	#1-1/2" #2-3/4" #3-1" #4-1 1/4" #5-1 1/2" #6-1 3/4" #7-2"	BRASS RINGS \$ .30 Ea .40 Ea .60 Ea .90 Ea 1.15 Ea 1.50 Ea 1.70 Ea	10 10 10 5 5 5 5	445	K-5	#1 #2 #3	\$250.00 Pr 250.00 Pr 350.00 Pr	
420	G-6	6" 8" 99A	FOG BELLS Pol Br Chrome \$50.00 Ea \$57.00 Ea 91.00 Ea 100.00 Ea 11.40 Ea 13.40 Ea		447	I-14	99A	KEEL PLATE \$ 8.30 Ea 4.40 Ea	5
423	I-13	#1 #2	PAD EYES \$ 8.75 Ea 12.25 Ea	5 5	448	K-8	#1 #2	ROD HOLDERS \$16.50 Ea 22.00 Ea	
424	C-9		CABLE OUTLET \$ 5.25 Ea	10	449	K-7	99A 99B	\$35.50 Ea 27.50 Ea 7.50 Ea	
425	K-4	#4-4 ft. #6-6 ft. #8-8 ft.	OUTRIGGER POLE HOLDERS \$550.00 Pr 580.00 Pr 620.00 Pr		450	D-2		BULKHEAD FIXTURES Pol Br Chrome \$12.70 Ea \$13.75 Ea	
426	K-4		MOUNTING BRACKET \$28.00 Ea		451	K-6	#1 #2	OUTRIGGER POLE HOLDER \$ 55.00 Pr 110.00 Pr	
429	I-14		LIFTING EYES \$18.00 Ea		452	K-8	99A	ROD HOLDER \$ 16.50 Ea .60 Ea	
430	I-14		\$20.50 Ea		453	I-29	#1-3/16" #2-1/4" #3-3/16" #4-3/8" #5-1/2"	ACORN NUTS \$ .35 Ea .35 Ea .65 Ea .65 Ea 2.30 Ea	10 10 10 5 5
431	I-5	#2-4 1/4"x4 1/4" #2 1/2-5"x5" #3-6"x6" #4-7"x7"	MOORING BITTS \$32.00 Ea 49.50 Ea 58.00 Ea 105.00 Ea		454B	B-8		SIGNAL LIGHT \$98.00 Ea	
432	A-9-12V		SEALED BEAM UNIT \$ 5.40 Ea		455	A-8	#1-6" #2-12"	STERN LIGHTS \$11.40 Ea 12.55 Ea	
433	E-6	#1-4 1/2" #2-6" #3-7"	SEALED BEAM UNITS 12 Volt 24 Volt 32 Volt \$ 7.00 Ea — — 12.75 Ea \$22.00 Ea — 15.50 Ea 28.25 Ea \$22.00 Ea		456	E-8		SPARE LIGHTER PLUG \$ 1.35 Ea	
434	I-14		LIFTING EYE \$18.65 Ea		457	E-8	#1-4 1/2" #3-7" #1-99A #3-99A 99B	HAND SPOT LIGHTS \$49.50 Ea 77.50 Ea 10.00 Ea 18.00 Ea 1.35 Ea	
435	E-6	#1-4 1/2" #2-6"	SEALED BEAM UNIT 12 Volt \$14.00 Ea 16.00 Ea		458	K-8	#1	ROD HOLDERS \$17.50 Ea	
438	A-8	#1-6" #2-12"	STERN LIGHTS \$18.40 Ea 20.25 Ea		459	K-8		\$15.25 Ea	
440	E-8	#1-4 1/2" #3-7"	HAND SPOTLIGHTS 12 Volt 32 Volt \$44.25 Ea — 68.00 Ea 76.65 Ea		460	K-2,6	15' 15'-99A 15'-99B 15'-99C	FIBERGLASS OUTRIGGERS \$65.75 Pr 12.75 Ea 12.75 Ea 12.75 Ea	
440-H	E-8	#1-4 1/2"	\$51.25 Ea		461	G-4		PORTLIGHT VINYL \$ 3.00 Lgth	
441	G-4		PORTLIGHT CHAIN \$ 6.35 Ea	5	465	I-29 G-6	#1-8-32 #2-1/4-20 #3-1/4-20 #4-3/16-18 #5-3/16-16 #7-1/2-13 #8-1/2-13 #9-3/8-11	ACORN NUTS Pln Pol Chrome Each Each Each \$ .20 \$ .30 \$ .50 .25 .40 .60 .50 — — .80 1.10 1.40 1.10 — — 1.85 — — 2.70 3.20 3.50 5.60 6.15 6.75	10 10 10 10 5 5 5
442	G-3	4" 5" 6" 8"	ROUND PORTLIGHT SCREENS \$12.00 Ea 13.15 Ea 13.40 Ea 19.25 Ea						

Where Standard Packaging Not Indicated, Packaged Quantity Is One Unit.

# N-16

Figure	Page	Size	List Price	Std. Pkg.	Figure	Page	Size	List Price	Std. Pkg.	
466	I-28	#1- $\frac{1}{8}$ " #2- $\frac{3}{16}$ " #3- $\frac{1}{4}$ " #4- $\frac{3}{8}$ " #5- $\frac{1}{2}$ " #6- $\frac{1}{2}$ " #7- $\frac{3}{4}$ " #8- $\frac{3}{4}$ " #9- $\frac{7}{8}$ " #10-1"	<b>WIRE ROPE THIMBLES</b>		20 20 20 20 20 20 10 10 10 10	490	C-3		<b>NAME PLATES</b>	5
			Galv S.S.	\$ .35 Ea \$ .65 Ea					\$ .45 Ea	
				.35 Ea .65 Ea					<b>BOAT HOOK HOLDER</b>	
				.35 Ea .70 Ea					\$ 2.10 Pr	
				.40 Ea 1.10 Ea					\$ 3.40 Card	
				.45 Ea 2.15 Ea					40.80 Box	
				.60 Ea 2.90 Ea						
				1.10 Ea —						
				2.00 Ea —						
				2.35 Ea —						
	3.25 Ea —									
467	H-18	99A 99B	<b>GALLEY PUMP</b>					<b>INTAKE WATER STRAINERS</b>		
				\$ 60.00 Ea 9.35 Ea 5.25 Ea				#3- $\frac{3}{8}$ " \$30.25 Ea #4- $\frac{1}{2}$ " 40.25 Ea #5- $\frac{3}{4}$ " 48.50 Ea #6-1" 57.00 Ea #7-1 $\frac{1}{4}$ " 65.75 Ea #8-1 $\frac{1}{2}$ " 86.00 Ea #9-2" 106.00 Ea #10-2 $\frac{1}{2}$ " 128.00 Ea		
468	K-2	I.D. #1- $\frac{9}{16}$ " #2- $\frac{3}{4}$ " #3- $\frac{3}{4}$ " #4-1" #5-1 $\frac{1}{16}$ " #6-1 $\frac{1}{8}$ "	<b>OUTRIGGER GUIDES</b>		6 6 6 6 6 6			<b>SPARE TOP CASTINGS</b>		
				\$ .85 Ea				#3-99A \$20.00 Ea		
				.85 Ea				#4-99A 26.25 Ea		
				1.25 Ea				#5-99A 31.75 Ea		
				1.25 Ea				#6-99A 37.25 Ea		
				1.35 Ea				#7-99A 43.00 Ea		
469	K-2		<b>OUTRIGGER TROLLING PIN</b>		10 1 Pr 6 Cds			<b>SPARE BOTTOM CASTINGS</b>		
				\$ 1.95 Ea				#3-99B \$12.30 Ea #4-99B 16.20 Ea #5-99B 19.60 Ea #6-99B 23.00 Ea #7-99B 26.50 Ea #8-99B 33.50 Ea #9-99B 42.50 Ea #10-99B 51.00 Ea		
469 SP	K-2 & L-23			\$ 6.10 Card 36.60 Box						
470	K-5	#1 #2 #3	<b>OUTRIGGER POLE HOLDERS</b>					<b>SPARE CYLINDERS</b>		
				\$270.00 Pr				#3-99C \$ 6.15 Ea		
				270.00 Pr				#4-99C 10.80 Ea		
472	C-7, E-6	#20-Dbl Contact #21-Sgl Contact	<b>BAYONET SOCKET</b>		10 10			#5-99C 12.95 Ea		
				\$ 2.65 Ea 2.65 Ea				#6-99C 15.25 Ea		
474	K-6	#1 #2 #3	<b>SPARE PLATES</b>					#7-99C 15.90 Ea		
				\$19.25 Ea				#8-99C 20.75 Ea		
				37.75 Ea				#9-99C 25.75 Ea		
475	K-9	99A 99B 99C	<b>ROD HOLDER</b>					#10-99C 25.75 Ea		
				PI Br Chrome						
				\$35.50 Ea \$61.00 Ea						
				25.50 Ea 41.50 Ea						
476	K-2		<b>FIBERGLASS OUTRIGGER KIT</b>		3 Kits			<b>SPARE BASKET STRAINERS</b>		
				\$83.00 Per Kit				#3-99D \$ 6.80 Ea #4-99D 9.00 Ea #5-99D 10.85 Ea #6-99D 12.65 Ea #7-99D 14.60 Ea #8-99D 18.30 Ea #9-99D 23.25 Ea #10-99D 28.00 Ea		
478	K-6	#1 #2	<b>SPARE BRACKETS</b>					#8-99E 6.70 Ea		
				\$20.00 Ea 37.00 Ea				#9-99E 8.50 Ea #10-99E 10.20 Ea		
479	K-6	#1 #2	<b>SPARE TUBES</b>					<b>SPARE COVER GASKETS</b>		
				\$13.00 Ea 25.00 Ea				#3-99F \$ 1.00 Ea #4-99F 1.10 Ea #5-99F 1.20 Ea		
482	K-9	#1 #2	<b>VINYL LINERS</b>							
				\$ 2.50 Ea 2.70 Ea						
483	K-9	#1 #2	<b>VINYL LINERS</b>							
				\$ 2.50 Ea 2.70 Ea						
486	I-14	#1- $\frac{5}{16}$ " #3- $\frac{3}{8}$ " #4- $\frac{1}{2}$ "	<b>COMBO KEEL PLATE — BOW EYE ASSY.</b>							
				\$18.65 Ea						
				19.80 Ea 25.50 Ea						
488	A-8		<b>MAST LIGHTS</b>							
				\$20.25 Ea						

Where Standard Packaging Not Indicated, Packaged Quantity Is One Unit.

Figure	Page	Size	List Price	Std. Pkg.	Figure	Page	Size	List Price	Std. Pkg.
		#6-99F #7-99F #8-99F #9-99F #10-99F	SPARE COVER GASKETS \$ 1.20 Ea 1.20 Ea 1.75 Ea 1.75 Ea 1.75 Ea				#6-1 1/4"x30" #7-1 1/4"x36" #8-1 1/4"x48"	\$ 19.00 Ea 22.50 Ea 29.75 Ea	
		#3-99G #4-99G #5-99G #6-99G #7-99G #8-99G #9-99G #10-99G	SPARE TIE RODS \$ 1.35 Ea 1.60 Ea 2.45 Ea 2.85 Ea 3.35 Ea 4.20 Ea 5.30 Ea 6.35 Ea		497	I-20	3/4"x6'	ALUMINUM TUBING \$ 8.15 Lgth	3 Lgths
		#3-99H #4-99H #5-99H #6-99H #7-99H #8-99H #9-99H #10-99H	SPARE NUT & WASHER FOR TIE ROD \$ 1.15 Ea 1.15 Ea 1.15 Ea 1.15 Ea 1.15 Ea 1.15 Ea 1.15 Ea 1.15 Ea		498	I-20	1"x6'	STAINLESS STEEL TUBING \$28.00 Lgth	3 Lgths
		#3-99J #4-99J #5-99J #6-99J #7-99J #8-99J #9-99J #10-99J	SPARE CYLINDER GASKET \$ 1.00 Ea 1.10 Ea 1.20 Ea 1.20 Ea 1.20 Ea 1.75 Ea 1.75 Ea 1.75 Ea		499	H-18	99A	WATER INLET FITTING \$15.15 Ea 2.25 Ea	
		#3-99K #4-99K #5-99K #6-99K #7-99K #8-99K #9-99K #10-99K	SPARE WING NUT & WASHER FOR COVER \$ .35 Ea .35 Ea .35 Ea .35 Ea .35 Ea .65 Ea .65 Ea .65 Ea		500	H-13	#9-2" #10-2 1/2" #11-3"	INTAKE WATER STRAINERS \$181.00 Ea 210.00 Ea 228.00 Ea	
		#3-99L #4-99L #5-99L #6-99L #7-99L #8-99L #9-99L #10-99L	SPARE HINGED BOLT FOR COVER WITH PIN, NUT AND WASHER \$ 2.25 Ea 2.25 Ea 2.25 Ea 2.25 Ea 2.25 Ea 3.30 Ea 3.30 Ea 3.30 Ea				#9-99A #10-99A #11-99A	SPARE TOP CASTING \$119.00 Ea 138.00 Ea 151.00 Ea	
494	E-8		SPARE DECK SOCKET \$ 5.95 Ea				#9-99B #10-99B #11-99B	SPARE BOTTOM CASTINGS \$ 73.00 Ea 85.00 Ea 92.00 Ea	
495	A-9	#1-1/2"x14" #2-3/4"x14" #3-3/4"x18"	FLAG STAFFS \$ 8.50 Ea 9.35 Ea 11.40 Ea	5 5 5			#9-99C #10-99C #11-99C	SPARE CYLINDERS \$ 48.75 Ea 55.00 Ea 58.00 Ea	
496	A-9	#2-3/4"x14" #3-3/4"x18" #4-1"x18" #5-1"x24"	MAHOGANY FLAG STAFFS \$10.60 Ea 12.20 Ea 12.20 Ea 13.25 Ea				#9-99D #10-99D #11-99D	SPARE BASKET STRAINERS \$ 40.25 Ea 46.75 Ea 51.00 Ea	
							#9-99E #10-99E #11-99E	SPARE COVERS \$ 13.55 Ea 16.95 Ea 21.75 Ea	
							#9-99F #10-99F #11-99F	SPARE COVER GASKETS \$ 2.10 Ea 2.10 Ea 2.10 Ea	
							#9-99G #10-99G #11-99G	SPARE TIE RODS \$ 9.10 Ea 10.60 Ea 11.65 Ea	
							#9-99H #10-99H #11-99H	SPARE NUT & WASHER FOR TIE ROD \$ 1.15 Ea 1.15 Ea 1.15 Ea	
							#9-99J #10-99J #11-99J	SPARE CYLINDER GASKET \$ 2.10 Ea 2.10 Ea 2.10 Ea	
							#9-99K #10-99K #11-99K	SPARE WING NUT & WASHER FOR COVER \$ .65 Ea .65 Ea .65 Ea	

Where Standard Packaging Not Indicated, Packaged Quantity Is One Unit.

# N-18

Figure	Page	Size	List Price	Std. Pkg.	Figure	Page	Size	List Price	Std. Pkg.
500	H-13	#9-99L #10-99L #11-99L	SPARE HINGED BOLT FOR COVER WITH PIN, NUT & WASHERS \$ 3.30 Ea 3.30 Ea 3.30 Ea				5"-99A 6"-99A 8"-99A	\$ 20.50 Ea \$24.50 Ea 28.25 Ea 36.75 Ea 46.50 Ea 49.75 Ea	
501	I-17		BOARDING STEP Pl Br Chrome \$19.25 Ea \$25.25 Ea		528	H-6	#5-3/4" #6-1" #7-1 1/4" #8-1 1/2" #9-2" #10-2 1/2" #11-3"	PIPE DECK PLATES Mach Pol Chr \$ 8.70 Ea \$12.55 Ea 9.90 Ea 13.80 Ea 12.55 Ea 16.70 Ea 14.60 Ea 18.45 Ea 22.25 Ea 28.50 Ea 30.75 Ea 35.25 Ea 41.75 Ea 46.75 Ea	
502	I-24	#1 #2	SPRING CLAMPS \$ 1.80 Pr 2.00 Pr	10 Pr 10 Pr	528D		#7-1 1/4" #8-1 1/2" #9-2"	12.55 Ea 16.70 Ea 14.60 Ea 18.45 Ea 22.25 Ea 28.50 Ea	
502 SP	I-24 & L-23	#1	\$ 2.70 Card 32.40 Box	1 Pr 12 Cds	528G		#7-1 1/4" #8-1 1/2" #9-2"	12.55 Ea 16.70 Ea 14.60 Ea 18.45 Ea 22.25 Ea 28.50 Ea	
503	F-5	#3 #4	GAS TANK VENT \$ 8.50 Ea 10.30 Ea	5 5	528W		#7-1 1/4" #8-1 1/2" #9-2"	12.55 Ea 16.70 Ea 14.60 Ea 18.45 Ea 22.25 Ea 28.50 Ea	
505	F-5		\$ 8.15 Ea	5			#7-1 1/4" #8-1 1/2" #9-2"	12.55 Ea 16.70 Ea 14.60 Ea 18.45 Ea 22.25 Ea 28.50 Ea	
506	F-5		\$ 3.50 Ea .60 Ea	10					
509	F-5	99A #4 #5 #4 99A #5 99A	\$ 7.30 Ea 9.35 Ea 1.20 Ea 1.50 Ea	10 10					
510	F-3	4" 5" 6" 8"	COWL VENTILATORS White Pol Br Chrome Each Each Each \$ 66.00 \$113.00 \$123.00 84.00 146.00 156.00 126.00 230.00 245.00 170.00 385.00 464.00					SPARE CAPS \$ 4.40 Ea \$ 6.30 Ea 5.00 Ea 6.95 Ea 6.30 Ea 8.30 Ea 7.30 Ea 9.20 Ea 11.00 Ea 14.30 Ea 15.30 Ea 17.65 Ea 21.00 Ea 23.25 Ea	
511A 511B 511C	C-3		MODULAR PANEL SECTIONS \$ 5.25 Ea 5.25 Ea 2.20 Ea	5 5 5				SPARE "O" RINGS \$ .55 Ea .55 Ea .55 Ea .55 Ea .65 Ea .65 Ea .65 Ea	
512	C-3		MODULAR SWITCH PANEL \$34.75 Ea						
514	C-2,3		SPARE SWITCH \$ 1.65 Ea		530	I-4	8" 10" 12" 15"	ALUMINUM SHIPS CLEATS \$ 6.15 Ea 8.75 Ea 13.15 Ea 19.25 Ea	
515	F-5	#3 #4	GAS TANK VENT \$ 7.35 Ea 9.00 Ea	10 10					
516	C-2,3		SPARE FUSE HOLDER \$ 1.70 Ea		532	B-10 11, 13 C-11	#1-50/50 Watt #2-100/100 Watt	MOGUL BULBS \$23.40 Ea 23.40 Ea	
517 517A	C-2		SWITCH PANEL \$30.00 Ea 31.50 Ea						
519	C-2		NAME PLATES \$ .50 Ea Each name plate has an assigned number—see page	5	533	I-24	#1-Straight #2-Curved #99A #99B #99C	HAND WINDSHIELD WIPERS \$14.30 Ea 15.75 Ea 7.00 Ea 1.85 Ea 3.45 Ea	
522	C-2,3		SPARE CAP FOR FUSE HOLDER \$ .90 Ea		533 SP	I-24 & L-16	#1	\$16.15 Card 48.45 Box	1 Pc 3 Cds
524	H-7	99A	"WASTE" FITTING \$ 18.95 Ea 9.50 Ea						
526	H-8	3" 4" 5" 6" 8" 3"-99A 4"-99A	REGULAR DECK PLATES Mach Pol Chr \$18.45 Ea \$26.75 Ea 29.00 Ea 35.00 Ea 41.00 Ea 49.00 Ea 56.00 Ea 73.00 Ea 92.00 Ea 100.00 Ea 9.20 Ea 13.40 Ea 14.45 Ea 17.50 Ea		534	E-8	#2-6" #3-7"	SEARCH LIGHTS 12 Volt 24 Volt 32 Volt Each Each Each \$ 97.00 \$ 99.00 — 99.00 108.00 105.00	
					534-H	E-8	#2-6"	100.00 — —	
					535	E-7	#2-6" #3-7"	\$117.00 \$119.00 — 119.00 127.00 124.00	
					535-H	E-7	#2-6"	\$120.00 — —	

Where Standard Packaging Not Indicated, Packaged Quantity Is One Unit.

Figure	Page	Size	List Price	Std. Pkg.	Figure	Page	Size	List Price	Std. Pkg.				
536	CONT'D E-7	SEARCH LIGHTS				565	I-30	TILLER ROPE PULLEY		10			
			12 Volt Each	24 Volt Each	32 Volt Each			\$ 2.35 Ea					
		#2A-36"	\$127.00	\$130.00	—	565SP	I-30 & L-17	\$ 6.10 Card	1 Pr				
		#2B-48"	132.00	134.00	—			73.20 Box		12 Cds			
		#2C-60"	136.00	138.00	—	566	I-2	CLEATS		10 10 10 5			
		#3A-36"	130.00	138.00	135.00			2" \$ 1.20 Ea					
		#3B-48"	134.00	143.00	139.00			3" 1.75 Ea					
		#3C-60"	138.00	147.00	144.00			4 1/2" 2.65 Ea					
536-H	E-7	#2-AH-36"	131.00	—	—			6" 4.10 Ea					
		#2-BH-48"	135.00	—	—			566SP	I-2 & L-14		2" \$ 3.50 Card	1 Pr	
#2-CH-60"	139.00	—	—	42.00 Box	12 Cds								
537	H-6	SAFETY CORD			5						3" \$ 4.65 Card	1 Pr	
			\$ .90 Ea					55.80 Box	12 Cds				
538 538-H	E-8	4 1/2"-12 Volt	SEARCH LIGHT					\$ 7.00 Card	1 Pr				
		4 1/2"-12 Volt	\$31.50 Ea					42.00 Box	6 Cds				
			38.50 Ea					\$ 5.85 Card	1 Pc				
								70.20 Box	12 Cds				
539	H-8	DECK PLATE KEYS				567	J-2	LATCH SET					
		#3	\$ 1.15 Ea					99A	\$ 19.55 Set				
		#4	1.75 Ea						1.20 Ea				
		#5	2.00 Ea										
		#6	3.50 Ea										
		#8	4.65 Ea										
544	I-4	CLEATS				572	I-3	HOLLOW BASE CLEATS		10 10 10 5			
			Pol Br	Chrome				4 1/2" \$10.50 Ea					
		3"	\$ 4.50 Ea	\$ 4.80 Ea	10			5 1/2" 11.40 Ea					
		4"	5.45 Ea	5.85 Ea	10			6 1/2" 13.40 Ea					
		5"	7.70 Ea	8.75 Ea	10			8" 16.65 Ea					
		6"	9.35 Ea	9.90 Ea	5			10" 26.75 Ea					
		8"	14.00 Ea	15.15 Ea				39.00 Ea					
		10"	21.00 Ea	22.50 Ea									
544SP	I-4 & L-15	4"	\$ 6.20 Card		1 Pc	574	J-4	DOOR STOPS					
			37.20 Box		6 Cds			#1	\$14.85 Ea				
						#2	15.15 Ea						
545	I-4	ALUMINUM CLEATS				575	J-7	LIFTING RING		5			
		3"	\$ 1.65 Ea		10				\$ 7.00 Ea				
		4"	2.35 Ea		10			575 SP	J-7 & L-20		\$ 8.25 Card		
		5"	2.50 Ea		10						99.00 Box		
		6"	2.80 Ea		10			578	J-18		BOAT COVER SOCKETS		
		8"	3.80 Ea		10						\$ 2.00 Pr		10 Pr
		10"	5.85 Ea		5						\$ 3.00 Card		1 Pr
		12"	7.60 Ea		5						36.00 Box		12 Cds
546	I-10	BOW CHOCKS				586	G-5	DRAIN FITTING					
		3"	\$ 7.90 Pr		5 Pr			\$11.00 Ea					
		4"	9.65 Pr		5 Pr			ANTI-COLLISION LIGHT					
		5"	18.00 Pr		5 Pr			\$59.95 Ea					
		6"	23.75 Pr					600	A-17	SAFETY MOORING HOOK			
8"	32.25 Pr			\$ 2.45 Ea		10							
546SP	I-10 & L-15	4"	\$11.65 Card		1 Pr	606	I-26	3.20 Ea	10				
			69.90 Box		6 Cds			#1 1/2	8.75 Ea	5			
						#2	\$ 3.40 Card		1 Pc				
							40.80 Box		12 Cds				
550	F-6	TRANSOM VENT			10	607	I-13	RING ON PLATE					
		\$ 3.40 Ea						#1	\$ 4.40 Ea		5		
554	J-6	DOOR CATCH			25	#2	5.75 Ea		5				
555	D-4	DOME LIGHT				608	I-5	MOORING BITTS					
		\$59.00 Ea						#1-3"x3"	\$17.80 Ea				
		LADDER HINGE						#2-4 1/4"x4 1/4"	30.00 Ea				
		\$17.50 Pr						#2 1/2-5"x5"	47.50 Ea				
556	J-17	DOOR CATCH			25	#3-6"x6"	55.00 Ea						
559	J-6	\$ .65 Ea			25	610	J-16	COAT HOOK		10			
559 SP	J-6 & L-21	\$ 2.10 Card			1 Pr			\$ 1.00 Ea					
		52.50 Box			25 Cds	610 SP	J-16 & L-21	\$ 3.20 Card		2 Pcs			
						19.20 Box		6 Cds					
560	J-6	MAGNETIC DOOR CATCH			25	612	I-26	FAST EYE SNAPS					
		\$ .85 Ea						#0	Galv	PI Br	10		
562	I-31	EYE STRAPS			50			#1	\$ 1.80 Ea	\$ 1.40 Ea	10		
		\$ .20 Ea						#2	2.25 Ea	1.70 Ea	10		
						#3	2.65 Ea	2.10 Ea	10				
							3.10 Ea	3.20 Ea	10				

Where Standard Packaging Not Indicated, Packaged Quantity Is One Unit.

# N-20

Figure	Page	Size	List Price	Std. Pkg.	Figure	Page	Size	List Price	Std. Pkg.
612	1-26	#4 #5 #6	FAST EYE SNAPS Galv PI Br \$ 4.10 Ea — 5.00 Ea — 6.30 Ea —	10 10 10	671	H-5	#3-3/4" #5-1" #6-1 1/2" #7-1 1/4" #8-1 3/8" #9-1 1/2"	SHAFT LOGS \$37.25 Ea 37.25 Ea 77.00 Ea 77.00 Ea 100.00 Ea 100.00 Ea	
613	1-26	#1 #2 #3 #4 #5	SWIVEL EYE SNAPS Galv PI Br \$ 2.95 Ea \$ 2.70 Ea 3.65 Ea 3.30 Ea 4.80 Ea 4.50 Ea 5.55 Ea — 7.20 Ea —	10 10 10 10 10	672	H-4,5	#3-3/4" #4-7/8" #5-1" #6-1 1/8" #7-1 1/4" #8-1 3/8" #9-1 1/2"	STUFFING BOXES \$15.50 Ea 15.50 Ea 15.50 Ea 22.50 Ea 22.50 Ea 35.00 Ea 35.00 Ea	
614	1-26		SAFETY SNAP \$ 5.30 Ea	10	673	H-4,5	#3 #4 #5 #6 #7 #8 #9	HOSE \$ 2.25 Ea 2.25 Ea 2.25 Ea 6.35 Ea 6.35 Ea 7.30 Ea 7.30 Ea	
626	C-6	3 gang 4 gang 5 gang 6 gang	FUSE PANELS \$ 3.00 Ea 4.10 Ea 4.90 Ea 6.00 Ea	5 5 5 5	680	I-27	#1-3/16" #2-1/4" #3-5/16" #4-3/8"	"S" HOOKS \$ .25 Ea .40 Ea .50 Ea .85 Ea	50 50 50 50
627	C-6	2 gang 4 gang 6 gang	TERMINAL BLOCKS \$ 1.80 Ea 3.20 Ea 4.65 Ea	5 5 5	688	C-6		TOGGLE SWITCH \$ 1.90 Ea	10
629	C-6	4 gang 6 gang 8 gang 12 gang	FUSE PANELS \$ 6.00 Ea 8.75 Ea 11.55 Ea 17.50 Ea	5 5	692	H-9		CHOKE CONTROL HANDLE \$11.55 Ea	5
630	G-8	12" 15" 18"	PARALLEL RULES \$ 7.70 Ea 8.15 Ea 10.50 Ea		693	G-8	#1-5 1/2" #2-7"	DIVIDERS \$ 4.75 Ea 11.00 Ea	5 5
634	I-30		PULLEY \$ 3.30 Ea	10	694	C-6		FUSE PANELS \$ 2.65 Ea	5
634 SP	I-30 & L-17		\$ 8.15 Card 97.80 Box	1 Pr 12 Cds	697	J-9		HATCH FASTENER \$ 6.15 Ea	10
647	C-6	4 gang 6 gang 8 gang 12 gang	FUSE AND TERMINAL BLOCKS \$10.00 Ea 14.00 Ea 17.50 Ea 26.75 Ea	5 5	703	C-6		SWITCH \$ 1.15 Ea	10
654	F-4		VENTILATOR \$24.50 Ea		703 SP	C-6 & L-7		\$ 1.85 Card 11.10 Box	1 Pc 6 Cds
657	H-2	#1-18x3/4" #2-18"x1" #3-20"x3/4" #4-20"x1" #5-22"x1" #6-24"x1" #7-28"x1" #8-30"x1"	STEERING WHEELS \$91.00 Ea 91.00 Ea 93.00 Ea 93.00 Ea 103.00 Ea 126.00 Ea 144.00 Ea 162.00 Ea		704	H-19		PUMP STRAINER \$13.75 Ea	
659	I-26		SWIVEL EYE SNAP \$ 1.85 Ea	25	705	H-19		\$12.25 Ea	
659 SP	I-26 & L-22		\$ 2.60 Card 26.00 Box	1 Pc 10 Cds	706	G-8		PROTRACTOR \$ 9.00 Ea	
663	A-7		GLARE SHIELD \$ 2.35 Ea		708	G-8		LOG BOOK \$ 7.50 Ea	
669	I-17	99A	LADDER LOCKS \$14.60 Set 7.00 Pr	5 Sets	709	H-19		PUMP STRAINER \$ 5.55 Ea	5
670	H-2	#1 #2	SPARE GRIPS \$ .70 Ea .95 Ea		714	H-20	#1 #2	GARBOARD DRAIN PLUGS \$ 4.10 Ea 4.65 Ea	5 5
					717	I-17	#99A-Spare plates #99B-Spare arms	LADDER HOOKS \$47.25 Set 15.75 Pr 35.00 Pr	
					719	J-11	#99A-Spare thumb screw #99B-Spare angle bracket	TABLE LEG FASTENER \$ 7.30 Ea 7.30 Ea 2.35 Ea	5 2.35 2.55

Where Standard Packaging Not Indicated, Packaged Quantity Is One Unit.

Figure	Page	Size	List Price	Std. Pkg.	Figure	Page	Size	List Price	Std. Pkg.
720	C-8 & L-7	2 Pole 3 Pole 4 Pole	LINE CONNECTORS \$ 1.35 Ea 1.90 Ea 2.35 Ea	5 5 5	762	J-10	#1-10" #2-12" #3-14"	HATCH HINGES \$19.25 Pr 19.80 Pr 21.50 Pr	
720SP	C-8 & L-7	2 Pole 3 Pole 4 Pole	\$ 2.00 Card 10.00 Box \$ 2.60 Card 13.00 Box \$ 3.20 Card 16.00 Box	1 Pc 5 Cds 1 Pc 5 Cds 1 Pc 5 Cds	769	J-9		WINDSHIELD KEEPER \$ 9.35 Ea	10
721	H-19		PUMP STRAINER \$12.25 Ea		770	J-10	#99A-Spare Nut #99B-Spare Keeper	HATCH FASTENER \$11.00 Ea 2.65 Ea 3.80 Ea	5
722	H-19		\$12.25 Ea		773	J-15		HATCH HINGES Burn Br Chrome \$21.25 Pr \$38.75 Pr	
732C 732SS	I-31 I-31		TILLER ROPE TIGHTENER \$ .80 Ea 1.60 Ea	%25 10	775	I-15	#1 #2	TRANSOM HANDLES \$ 4.20 Ea 6.15 Ea	10 10
732 SP Cad	I-31 & L-17		\$ 2.55 Card 30.60 Box	1 Pr 12 Cds	775SP	I-15 & L-13	#2	\$14.00 Card 84.00 Box	1 Pr 6 Cds
732 SP S S	I-31 & L-17		\$ 4.20 Card 50.40 Box	1 Pr 12 Cds	776	J-7	#1 #2	HATCH HANDLES Burn Br Chrome \$ 7.00 Ea \$ 9.10 Ea 9.35 Ea 11.65 Ea	5 5
734	H-4	#5-1" #6-1 1/8" #7-1 1/4" #9-1 1/2"	STUFFING BOXES \$35.50 Ea 44.00 Ea 46.50 Ea 70.00 Ea		776SP	J-7 & L-20	#1	\$10.50 Card 63.00 Box	1 Pc 6 Cds
737	H-20	#1 #2	GARBOARD DRAIN PLUGS \$ 6.25 Ea 6.85 Ea	5 5	778	F-2	#1-Sat-3" #2-Nat-4"	EXHAUST BLOWERS \$37.25 Ea 85.00 Ea	
739	C-8		CONNECTOR \$ 7.00 Ea		786	C-9		CONNECTOR \$ 1.15 Ea	10
741	I-5	#0-3/8" #1-3/4-1" #0-99A #1-99A	ROPE DECK PIPE \$15.15 Ea 24.50 Ea 8.15 Ea 12.70 Ea		786 SP	C-9 & L-7		\$ 1.80 Card 18.00 Box	1 Pc 10Cds
742	H-20	#1 #2	SPARE PLUGS \$ 1.50 Ea 2.10 Ea		787	F-3		ADAPTER \$ 4.10 Ea	
745	C-6, D-5		TOGGLE SWITCH \$ 1.50 Ea	10	789	F-3	#2-25' #3-25' #4-25'	EXHAUST DUCT \$23.25 Lgth 25.25 Lgth 28.00 Lgth	2 2 2
747	A-19		D.C. SOCKET \$ 2.90 Ea	10	791	F-2	#1-Sat-3" #2-Nat-4"	EXHAUST BLOWERS \$39.75 Ea 90.00 Ea	
750	I-5	99A	DECK PIPE \$ 30.00 Ea 16.90 Ea		795	G-5		ASH TRAY \$12.00 Ea	
751	C-8		CONNECTOR \$ 2.45 Ea	10	796	G-2	#1-5"x12" #2-7"x16"	WINDOWS Alum Bronze \$49.50 Ea \$ 75.00 Ea 61.00 Ea 101.00 Ea	
752	1-4		HAWSE HOLE PLATE Pl Br Chrome \$12.70 Ea \$18.95 Ea		797	J-9		HATCH ADJUSTER \$16.30 Ea	
753	D-5	#1 #2	DOMELIGHTS \$77.00 Ea 81.00 Ea		800 801 802	E-6	6V 108W 12V 100 C.P. 32V 300W	SEARCHLIGHT BULBS \$15.15 Ea 7.60 Ea 23.50 Ea	
754	I-31		TILLER ROPE TIGHTENER \$ .60 Ea	25	803	G-2	#1-5"x12" #2-7"x16"	WINDOWS Alum Bronze \$43.00 Ea \$ 66.00 Ea 53.00 Ea 90.00 Ea	
755	H-17		EXHAUST FLANGE Pl Br Chrome \$ 9.70 Ea \$13.80 Ea		804	G-5		GLASS HOLDER \$12.65 Ea	
757	I-5		ROPE DECK PIPE \$ 6.15 Ea		805	H-14	#5-3/4" #6-1" #7-1 1/4" #8-1 1/2"	SEACOCK BODY \$ 37.50 Ea 50.00 Ea 58.00 Ea 76.00 Ea	
759	I-23	#1-10" #2-18"	DOCK LINE SPRINGS \$ 6.35 Ea 16.30 Ea	%5Pcs %1 Pc	761	D-4		DOMELIGHT \$ 4.65 Ea	

Where Standard Packaging Not Indicated, Packaged Quantity Is One Unit.

# N-22

Figure	Page	Size	List Price	Std. Pkg.	Figure	Page	Size	List Price	Std. Pkg.
807	E-6	120V 500W	SEARCHLIGHT BULB \$13.95 Ea		824	F-2	#1 #2	SPARE BLOWER IMPELLER \$ 3.50 Ea 4.20 Ea	
808	J-13		DOOR HINGES \$ 5.85 Ea	5 Pr	825	H-14	#4-1/2" #5-3/4" #6-1" #7-1 1/4" #8-1 1/2"	SEACOCK BODY \$19.50 Ea 22.50 Ea 30.50 Ea 45.00 Ea 61.00 Ea	
808 SP	J-13 & L-19		\$ 7.15 Card 71.50 Box	1 Pr 10 Cds					
809	E-6	120V 750W	SEARCHLIGHT BULBS \$19.25 Ea		826	H-8		DECK PLATE KEY \$ 7.00 Ea	5
810	E-5,6	120V 1000W	17.00 Ea		827	H-8		\$ 1.95 Ea	10
811	E-6	120V 1000W	SEARCHLIGHT BULB \$23.25 Ea		827 SP	H-8 & L-12		\$ 3.00 Card 18.00 Box	1 Pc 6 Cds
812	G-2	#1-5"x12" #2-7"x16"	PORTLIGHT FRAMES Alum Bronze \$ 5.80 Ea \$ 8.25 Ea 7.15 Ea 11.55 Ea		828	I-19		ROWLOCK HORNS \$ 7.00 Pr	%5
813	G-2	#1-5"x12" #2-7"x16"	\$ 8.80 Ea \$12.65 Ea 10.45 Ea 17.60 Ea		829	I-19	#0 #1	\$ 6.90 Pr 8.75 Pr	%5 %5
814	G-3	#1-5"x12" #2-7"x16"	PORTLIGHT SCREENS Chrome \$ 6.60 Ea 8.80 Ea		830	I-19	99A	\$ 7.70 Pr .30 Ea	%5 10
815	H-3	#5-1" #6-1 1/2" #7-1 1/4" #8-1 1/2" #9-1 1/2"	RUDDER COLLARS \$ 7.00 Ea 7.90 Ea 11.00 Ea 11.65 Ea 12.65 Ea		831	I-19		ROWLOCK SOCKETS \$ 3.70 Pr	%5
816	E-6	12V 100W	SEARCHLIGHT BULBS \$15.15 Ea		832	I-19		\$ 5.30 Pr	%5
817	E-6	32V 200W	27.75 Ea		833	I-19		\$ 5.85 Pr	%5
818	H-3	#5-1" #6-1 1/2" #7-1 1/4"	RUDDERS \$100.00 Ea 128.00 Ea 164.00 Ea		834	H-14	#5-3/4" #6-1" #7-1 1/4" #8-1 1/2"	SEACOCKS WITH CURVED TAIL PIECE \$48.00 Ea 64.00 Ea 76.00 Ea 101.00 Ea	
819	H-4	#7-1 1/4" #8-1 1/2" #9-1 1/2" #10-1 3/4" #11-2"	STUFFING BOXES \$ 49.75 Ea 65.00 Ea 83.00 Ea 104.00 Ea 112.00 Ea		835	H-14	#5-3/4" #6-1" #7-1 1/4" #8-1 1/2"	SEACOCKS WITH CURVED TAIL PIECE \$47.50 Ea 64.00 Ea 75.75 Ea 100.00 Ea	
820	E-6	120V 600W	SEARCHLIGHT BULB \$16.00 Ea		836	E-6	24V 150W	SEARCHLIGHT BULB \$13.20 Ea	
821	H-14	#4-1/2" #5-3/4" #6-1" #7-1 1/4" #8-1 1/2"	SEACOCKS WITH STRAIGHT TAIL PIECE \$25.50 Ea 30.25 Ea 41.25 Ea 61.00 Ea 81.00 Ea		837	E-5	120V 750W	SEARCHLIGHT BULB \$18.00 Ea	
822	F-2	#1 #2	SPARE BLOWER MOTORS \$23.25 Ea 41.75 Ea		838	G-3	4" 5" 6" 8"	DECK LIGHT \$17.80 Ea 20.25 Ea 22.50 Ea 44.25 Ea	
823	H-14	#4-1/2" #5-3/4" #6-1" #7-1 1/4" #8-1 1/2"	SEACOCKS WITH CURVED TAIL PIECE \$26.00 Ea 31.00 Ea 42.00 Ea 61.75 Ea 82.00 Ea		839	E-5	120V 900W	SEARCHLIGHT BULBS \$25.00 Ea	
					840	E-5	120V 1500W	\$37.00 Ea	
					841	J-7		RING PULLS \$ 3.20 Ea	10
					841 SP	J-7 & L-20		\$ 4.10 Card 49.20 Box	1 Pc 12 Cds
					842	I-27		SNAP \$ .80 Ea	50
					843	E-5	120V 2000W	SEARCHLIGHT BULBS \$68.00 Ea	
					849	E-4	#1 #2 #3	SEARCHLIGHT SUPPORTS \$115.00 Ea 122.00 Ea 125.00 Ea	

Where Standard Packaging Not Indicated, Packaged Quantity Is One Unit.



Figure	Page	Size	List Price	Std. Pkg.	Figure	Page	Size	List Price	Std. Pkg.
849	CONT'D E-4	#4 #5	SEARCHLIGHT SUPPORTS 130.00 Ea 145.00 Ea				#3B-14" #1C-10" #2C-12" #3C-14"	500.00 490.00 575.00 \$325.00 \$315.00 \$390.00 410.00 400.00 495.00 510.00 500.00 595.00	
851	E-6		SEARCHLIGHT CONTROL ASSEMBLIES \$55.00 Ea		884M	E-4	#1-10" #2-12" #3-14"	\$325.00 \$315.00 \$390.00 410.00 400.00 495.00 520.00 510.00 615.00	
852	E-6		65.00 Ea		884S	E-3,4	#1A-10" #2A-12" #3A-14"	\$335.00 \$325.00 \$400.00 420.00 410.00 505.00 540.00 530.00 635.00	
853	E-6		65.00 Ea				#1B-10" #2B-12" #3B-14"	\$345.00 \$335.00 \$410.00 430.00 420.00 515.00 550.00 540.00 645.00	
854	E-6		75.00 Ea				#1C-10" #2C-12" #3C-14"	\$355.00 \$345.00 \$420.00 440.00 430.00 525.00 560.00 550.00 655.00	
855	E-6		85.00 Ea		884T	E-3,4	#1A-10" #2A-12" #3A-14"	\$375.00 \$365.00 \$440.00 460.00 450.00 545.00 600.00 590.00 695.00	
856	E-6		75.00 Ea				#1B-10" #2B-12" #3B-14"	\$385.00 \$375.00 \$450.00 470.00 460.00 555.00 610.00 600.00 705.00	
857	E-6		85.00 Ea				#1C-10" #2C-12" #3C-14"	\$395.00 \$385.00 \$460.00 480.00 470.00 565.00 620.00 610.00 715.00	
858	E-6		95.00 Ea		885	E-2	#1-10" #2-12" #3-14"	\$295.00 \$285.00 \$360.00 380.00 370.00 465.00 490.00 480.00 585.00	
863	I-13		SKI TOW HOOKS \$ 5.85 Ea	5	885H	E-4	#1-10" #2-12" #3-14"	\$365.00 \$355.00 \$430.00 450.00 440.00 535.00 590.00 580.00 685.00	
863 SP	I-13 & L-16		\$ 7.55 Card 45.30 Box	1 Pc 6 Cds	885L	E-3	#1A-10" #2A-12" #3A-14"	\$305.00 \$295.00 \$370.00 390.00 380.00 475.00 500.00 490.00 595.00	
865	H-9	#1 #1A #1B #1C #2 #2A #2B #2C #8	STEERER CONTROL PARTS \$20.25 Ea 23.75 Ea 23.75 Ea 23.75 Ea 7.35 Ea 7.35 Ea 10.50 Ea 10.50 Ea 8.50 Ea		885M	E-4	#1-10" #2-12" #3-14"	\$325.00 \$315.00 \$390.00 410.00 400.00 495.00 530.00 520.00 625.00	
866	E-6		SPARE SOCKET \$ 6.00 Ea		885S	E-3,4	#1A-10" #2A-12" #3A-14"	\$335.00 \$325.00 \$400.00 420.00 410.00 505.00 540.00 530.00 635.00	
870	F-4	#2-3" #3-3 1/2"	VENTS \$ 7.90 Ea 9.35 Ea		885T	E-3,4	#1B-10" #2B-12" #3B-14"	\$345.00 \$335.00 \$410.00 430.00 420.00 515.00 550.00 540.00 645.00	
881	I-31	#0 #1 #2	EYE STRAPS Natural Chrome \$ 1.40 Ea \$ 2.75 Ea 2.00 Ea 3.60 Ea 2.25 Ea 4.00 Ea	50 50 25	885M	E-4	#1-10" #2-12" #3-14"	\$325.00 \$315.00 \$390.00 410.00 400.00 495.00 520.00 510.00 615.00	
882	I-25	#1 #2	DECK STRAPS Pl Br Chrome \$ 2.30 Ea \$ 2.90 Ea 2.30 Ea 4.90 Ea	10 10	885S	E-3,4	#1A-10" #2A-12" #3A-14"	\$335.00 \$325.00 \$400.00 420.00 410.00 505.00 540.00 530.00 635.00	
883	E-2	#1-10" #2-12" #3-14"	SEARCHLIGHTS Pol Satin Pol Br Chrome Chrome Each Each Each \$275.00 \$265.00 \$315.00 375.00 365.00 420.00 430.00 420.00 500.00		885T	E-3,4	#1B-10" #2B-12" #3B-14"	\$345.00 \$335.00 \$410.00 430.00 420.00 515.00 550.00 540.00 645.00	
883H	E-4	#1-10" #2-12" #3-14"	\$335.00 \$325.00 \$375.00 435.00 425.00 480.00 510.00 500.00 580.00		885T	E-3,4	#1C-10" #2C-12" #3C-14"	\$355.00 \$345.00 \$420.00 440.00 430.00 525.00 560.00 550.00 655.00	
883M	E-4	#1-10" #2-12" #3-14"	\$285.00 \$275.00 \$325.00 385.00 375.00 430.00 440.00 430.00 510.00		884	E-2	#1-10" #2-12" #3-14"	\$295.00 \$285.00 \$360.00 380.00 370.00 465.00 480.00 470.00 575.00	
884	E-2	#1-10" #2-12" #3-14"	\$295.00 \$285.00 \$360.00 380.00 370.00 465.00 480.00 470.00 575.00		884H	E-4	#1-10" #2-12" #3-14"	\$365.00 \$355.00 \$430.00 450.00 440.00 535.00 580.00 570.00 675.00	
884H	E-4	#1-10" #2-12" #3-14"	\$365.00 \$355.00 \$430.00 450.00 440.00 535.00 580.00 570.00 675.00		884L	E-3	#1A-10" #2A-12" #3A-14"	\$305.00 \$295.00 \$370.00 390.00 380.00 475.00 490.00 480.00 585.00	
884L	E-3	#1A-10" #2A-12" #3A-14" #1B-10" #2B-12"	\$305.00 \$295.00 \$370.00 390.00 380.00 475.00 490.00 480.00 585.00 \$315.00 \$295.00 \$380.00 400.00 390.00 485.00		890	E-6	#1-10" #2-12" #3-14"	SEARCHLIGHT REFLECTORS \$ 56.00 Ea 61.00 Ea 122.00 Ea	

Where Standard Packaging Not Indicated, Packaged Quantity Is One Unit.

Figure	Page	Size	List Price	Std. Pkg.	Figure	Page	Size	List Price	Std. Pkg.					
891	E-6	#1-10" #2-12" #3-14"	SEARCHLIGHT DOOR & GLASS			918	J-2	99A	LOCK SETS					
			Pol Satin Pol	\$ 30.25 Set										
			Br Chrome Chrome	2.65 Ea										
Each Each Each	\$ 30.25 Set													
892	E-6		FOCUSING DEVICE			919	J-2	99A	1.15 Ea					
			Pol Satin Pol											
			Br Chrome Chrome											
893	E-6		SPARE MOGUL PREFOCUS SOCKET			923	I-29	#0-12" #1-14" #2-16" #3-18" #4-20"	HAND FIDS					
			\$34.00 Ea SOCKET						\$ 5.55 Ea	2				
			\$ 1.70 Ea						6.35 Ea	2				
894	E-6		\$ 6.50 Ea					7.60 Ea	2					
895	E-6							8.15 Ea	2					
896	J-19		FASTENERS \$ 7.00 C			924	J-14		HINGE \$ 4.45 Pr		5 Pr			
			SOCKET \$ 2.70 Ea						924 SP	J-14 & L-19		\$ 5.70 Card		1 Pr
			FASTENERS \$ 5.85 C									68.40 Box		12 Cds
SOCKET \$ 2.35 Ea						DOOR KNOB \$ 2.35 Ea		10						
897	E-6		FASTENERS \$ 7.00 C			927	J-2	99A 99B	LOCK SET \$ 26.75 Set					
			SOCKET \$ 2.70 Ea						2.65 Ea					
			FASTENERS \$ 5.85 C						11.65 Ea					
898	J-19		FASTENERS \$ 5.85 C			928	J-2	99A	18.65 Set					
			SOCKET \$ 2.35 Ea						2.35 Ea					
			FASTENERS \$15.75 C											
899	E-6		\$ 3.50 C	100	929	J-14		HINGE \$ 2.75 Pr		10 Pr				
900	J-19		\$ 3.50 C	100				930	J-2	99A	LOCK SET \$ 18.65 Set			
901	J-19		\$ 3.50 C	100							1.20 Ea			
902	E-6	#1-10" #2-12" #3-14"	SEARCHLIGHT REAR COVER			933	I-11				#1 #2	ANCHOR CHOCKS		5 Sets 1 Set
			Pol Satin Pol	\$15.50 Set				\$16.90 Set						
			Br Chrome Chrome	18.00 Set				19.80 Set						
903	A-12		BOW LIGHT \$11.00 Ea			Shank Support	#1-99A	\$ 6.15 Ea	\$ 7.00 Ea					
			904	A-5		FASTENER \$12.70 Ea			Fluke Support		#1-99B	4.65 Pr	5.30 Pr	
						FASTENER \$ 3.50 C			Crown Support		#1-99C	4.65 Ea	5.30 Ea	
SEARCHLIGHT REAR COVER						Shank Support	#2-99A	\$ 7.60 Ea	\$ 8.15 Ea					
906	J-19		FASTENER \$13.40 C			Fluke Support	#2-99B	5.40 Pr	6.00 Pr					
			907	J-19		FASTENER \$ 3.50 C			Crown Support		#2-99C	5.40 Ea	6.00 Ea	
						SEARCHLIGHT REAR COVER			WINDOW LOCK \$ 2.90 Ea		5			
Pol Satin Pol	\$25.25 Ea													
908	E-6	#1-10" #2-12" #3-14"	Br Chrome Chrome			935	J-11		WINDOW STOP \$ 3.60 Ea		5			
			Each Each Each	27.25 Ea										
			\$52.50 \$52.50 \$60.00											
909	H-2	#1-16"x3/4" #2-16"x1" #3-20"x3/4" #4-20"x1" #5-24"x1"	STEERING WHEELS			936	I-21	#1-12" #2-18"	GRAB RAIL					
			Pol Br Chrome	\$20.50 Ea										
			\$56.00 Ea \$63.00 Ea	2.90 Ea										
910	A-12		SIDE LIGHTS \$23.25 Pr			937	J-11		WINDOW LOCK \$ 3.50 Ea		5			
			STAINLESS STEEL TUBING \$28.50 Lgth						\$ 8.40 Card		1 Pr			
			FASTENER \$14.00 C						50.40 Box		6 Cds			
915	A-12		12.55 Ea		939	A-15	12V 99B 99C	STERN LIGHTS \$ 20.50 Ea						
915R			12.55 Ea					2.90 Ea						
915G			12.55 Ea					1.15 Ea						
916	I-20	3/8"x6'	FASTENER \$14.00 C			940	G-4	2# thru 10#	SOUNDING LEAD \$ 1.75 Lb					
			HINGE \$ 4.20 Pr						5 Pr					
			HINGE \$ 4.20 Pr						5 Pr					
917	J-19		FASTENER \$14.00 C			943	J-11		SPARE KNOB \$ .50 Ea					
			SPARE TIP \$ .25 Ea											
			STERN LIGHTS \$ 9.65 Ea											

Where Standard Packaging Not Indicated, Packaged Quantity Is One Unit.

Figure	Page	Size	List Price	Std. Pkg.	Figure	Page	Size	List Price	Std. Pkg.
945 SP	CONT'D A-15 & L-3		<b>STERNLIGHTS</b> \$11.15 Card 44.60 Box	1 Pc 4 Cds	960	J-2	99A	<b>LOCK SET</b> \$ 18.40 Set 1.20 Ea	
946	A-15	12V	\$12.25 Ea		962	J-2		<b>KNOB/LEVER ASSEMBLY</b> \$ 8.75 Ea	
946	A-15	99A 99B	<b>STERN LIGHTS</b> \$ 1.15 Ea 2.90 Ea		963 963R 963G	A-13		<b>SIDE LIGHTS</b> \$18.65 Pr 10.25 Ea 10.25 Ea	
947	J-5	#1 #2 #3	<b>BARREL BOLTS</b> Pl Br Chrome \$ 5.85 Ea \$ 6.35 Ea 6.15 Ea 6.75 Ea 7.00 Ea 7.90 Ea	5 5 5	964 964 SP	A-13 A-13 & L-3		<b>BOW LIGHTS</b> \$ 9.35 Ea \$10.85 Card 43.40 Box	1 Pc 4 Cds
947 SP	J-5 & L-18	#2	\$ 7.70 Card 38.50 Box	1 Pc 5 Cds	965 965 SP	A-13 A-13 & L-3		<b>STERN LIGHT</b> \$ 9.35 Ea \$10.85 Card 43.40 Box	1 Pc 4 Cds
948	J-3		<b>SAFETY LATCH</b> \$ 7.90 Ea	5	967	J-9		<b>WINDSHIELD KEEPER</b> \$12.25 Ea	5
949	J-12	#1-1 1/2"x1 1/4" #2-1 1/2"x1 1/2" #3-2"x1 1/2" #4-2"x2" #5-2 1/2"x2" #6-2 1/2"x2 1/2" #7-3"x3"	<b>BUTT HINGES</b> Pl Br Chrome Pair Pair \$ 5.30 \$ 7.15 5.55 7.20 6.10 8.50 7.15 9.35 7.95 10.20 9.00 11.65 11.65 14.30	5 Pr 5 Pr 5 Pr 5 Pr	970 972 972 SP	A-5 A-5 A-5 & L-2		<b>BOW LIGHT</b> \$17.50 Ea \$10.50 Ea \$11.90 Card 47.60 Box	1 Pc 4 Cds
951	J-13	#1-3" #2-4"	<b>HINGE</b> \$10.80 Pr 11.65 Pr	5 Pr 5 Pr	973	I-21		<b>RAIL FITTINGS</b> \$12.55 Ea	
952	J-12	#1-1 1/2"x1 1/4" #2-1 1/2"x1 1/2" #3-2"x1 1/2" #4-2"x2" #5-2 1/2"x2" #6-2 1/2"x2 1/2" #7-3"x3"	<b>BUTT HINGES</b> Pl Br Chrome Pair Pair \$ 5.30 \$ 7.15 5.55 7.20 6.10 8.50 7.15 9.35 7.95 10.20 9.00 11.65 11.65 14.30	5 Pr 5 Pr 5 Pr 5 Pr	974	A-5		<b>BOW LIGHT</b> \$17.50 Ea	
953	J-2		<b>ESCUTCHEON/TUMBLER SET</b> \$11.65 Ea		975	J-16	#1-2" #2-3"	<b>COAT HOOK</b> \$ 1.00 Ea 1.25 Ea	10 10
954	J-11		<b>WINDOW HANDLE</b> \$ 2.00 Ea	5	977	I-21		<b>RAIL FITTING</b> \$12.70 Ea	
955 955R 955G	A-12		<b>SIDE LIGHTS</b> \$21.25 Pr 12.00 Ea 12.00 Ea		978	J-3		<b>CUPBOARD TURN</b> \$ 7.90 Ea	5
955 SP	A-12 & L-3		\$22.75 Card 91.00 Box	1 Pr 4 Cds	979	J-17		<b>HASP</b> Pol Br Chrome \$ 2.65 Ea \$ 3.60 Ea	10
956	J-4	#1-1 1/2" #2-2" #3-2 1/2" #4-3" #5-3 1/2" #6-4" #7-5" #8-6"	<b>DOOR HOOKS</b> Pl Br Chrome \$ 3.30 Ea \$ 3.85 Ea 3.40 Ea 4.00 Ea 3.50 Ea 4.10 Ea 3.65 Ea 4.25 Ea 3.80 Ea 4.45 Ea 5.25 Ea 6.00 Ea 5.55 Ea 6.75 Ea 5.95 Ea 7.30 Ea	5 5 5 5 5 5 5 5	981	I-21		<b>RAIL FITTING</b> \$13.75 Ea	
957	J-14		<b>NON-MORTISED HINGE</b> \$ 5.00 Pr	5 Pr	982	B-14	#1	<b>MASTHEAD LIGHTS</b> Galv Pl Br Pol Br Each Each Each \$102.00 \$152.00 \$167.00	
958	J-16		<b>DRAWER PULL</b> \$ 2.90 Ea	10	982R	B-14	#1	102.00 152.00 167.00	
959	J-4,17		<b>SPARE KEEPER</b> Pl Br Chrome \$ 1.60 Ea \$ 1.80 Ea		982M	B-14	#1	102.00 152.00 167.00	
					982B	B-6	#1	102.00 152.00 167.00	
					982RB	B-13	#1	102.00 152.00 167.00	
					982MB	B-13	#1	102.00 152.00 167.00	
					982C	B-13	#1	102.00 152.00 167.00	
					982RC	B-13	#1	102.00 152.00 167.00	
					982MC	B-13	#1	102.00 152.00 167.00	
					982	B-14	#2	\$128.00 \$190.00 \$212.00	
					982R	B-14	#2	128.00 190.00 212.00	
					982M	B-14	#2	128.00 190.00 212.00	
					982B	B-6	#2	128.00 190.00 212.00	
					982RB	B-13	#2	128.00 190.00 212.00	
					982MB	B-13	#2	128.00 190.00 212.00	
					982C	B-13	#2	128.00 190.00 212.00	
					982RC	B-13	#2	128.00 190.00 212.00	
					982MC	B-13	#2	128.00 190.00 212.00	
					983B	B-5	#1	\$ 96.00 \$144.00 \$160.00	
					983RB	B-12	#1	96.00 144.00 160.00	
					983MB	B-12	#1	96.00 144.00 160.00	
					983C	B-12	#1	96.00 144.00 160.00	

Where Standard Packaging Not Indicated, Packaged Quantity Is One Unit.

Figure	Page	Size	List Price	Std. Pkg.	Figure	Page	Size	List Price	Std. Pkg.
983RC	B-12	#1	MASTHEAD LIGHTS		996	J-19		11.00 C	100
983MC	B-12	#1	Galv	Pl Br	997	J-19		6.00 C	100
			Each	Each				HASPS	
983B	B-5	#2	\$121.00	\$181.00	998	J-17	#1-2"	\$ 6.15 Ea	10
983RB	B-12	#2	121.00	181.00			#2-3"	7.00 Ea	10
983MB	B-12	#2	121.00	181.00	999	J-13	3 1/2"	HINGE	5 Pr
983C	B-12	#2	121.00	181.00				\$11.00 Pr	
983RC	B-12	#2	121.00	181.00	1017	I-25		RING BUOY BRACKET	
983MC	B-12	#2	121.00	181.00				Pl Br Chrome	
					1017SP	I-25 & L-22		\$ 6.35 Ea \$ 9.65 Ea	5
								\$11.30 Card	1 Pc
								45.20 Box	4 Cds
985	B-14	#1	STERN LIGHTS		1020	I-13		RING AND STRAP	
985R	B-14	#1	\$102.00	\$152.00				Pl Br Chrome	
985M	B-14	#1	102.00	152.00				\$ 3.00 Ea \$ 6.30 Ea	5
985B	B-6	#1	102.00	152.00	1024	D-7	#1	HOUSE FIXTURES	
985RB	B-13	#1	102.00	152.00			#2	\$ 66.00 Ea	
985C	B-13	#1	102.00	152.00			#3	78.00 Ea	
985RC	B-13	#1	102.00	152.00			#4	200.00 Ea	
985MC	B-13	#1	102.00	152.00	1024R		#1	253.00 Ea	
							#2	\$ 66.00 Ea	
985	B-14	#2	\$128.00	\$190.00			#3	78.00 Ea	
985R	B-14	#2	128.00	190.00			#4	200.00 Ea	
985M	B-14	#2	128.00	190.00	1024G		#1	253.00 Ea	
							#2	\$ 66.00 Ea	
							#3	78.00 Ea	
					1024M		#4	200.00 Ea	
							#1	253.00 Ea	
							#2	\$ 66.00 Ea	
							#3	78.00 Ea	
					1024F		#4	200.00 Ea	
							#1	253.00 Ea	
							#2	\$ 66.00 Ea	
							#3	78.00 Ea	
							#4	200.00 Ea	
					1025	D-7	#1	253.00 Ea	
							#2	\$ 66.00 Ea	
					1025R		#1	78.00 Ea	
							#2	\$ 66.00 Ea	
					1025G		#1	78.00 Ea	
							#2	\$ 66.00 Ea	
					1025M		#1	78.00 Ea	
							#2	\$ 66.00 Ea	
					1025F		#1	78.00 Ea	
							#2	\$ 66.00 Ea	
					1032F	D-7	#1	78.00 Ea	
							#2	\$ 92.00 Ea	
							#3	109.00 Ea	
					1032CL		#1	175.00 Ea	
							#2	\$ 92.00 Ea	
							#3	109.00 Ea	
							#1	175.00 Ea	
					1041	I-27		SNAPS	
								\$ 1.15 Ea	50
					1042	I-27		\$ .90 Ea	50
								STEP PLATES	
					1043	I-16	#0-8"x2 1/4"	\$ 7.90 Ea	6
							#1-8 3/4"x3 1/4"	11.65 Ea	6
							#2-11 1/2"x5 3/4"	18.40 Ea	6
					1045	D-6	#2	HOUSE FIXTURE	
							99A	\$147.00 Ea	
							99B	3.50 Ea	
								3.25 Ea	
					1050B	I-16		STEP PADS	
							#0-7 1/2"x1 1/2"	\$ 1.20 Ea	5
							#1-7 1/2"x2 1/2"	1.65 Ea	5

Where Standard Packaging Not Indicated, Packaged Quantity Is One Unit.

Figure	Page	Size	List Price	Std. Pkg.	Figure	Page	Size	List Price	Std. Pkg.
1050T	CONT'D		<b>STEP PADS</b>				#16B	\$ 8.50 Ea	
		#0-7 $\frac{3}{8}$ "x1 $\frac{1}{2}$ "	1.20 Ea	5			#16C	9.50 Ea	
1050W		#1-7 $\frac{3}{8}$ "x2 $\frac{1}{2}$ "	1.65 Ea	5			#16D	11.00 Ea	
		#0-7 $\frac{3}{8}$ "x1 $\frac{1}{2}$ "	1.20 Ea	5			#16E	15.00 Ea	
		#1-7 $\frac{3}{8}$ "x2 $\frac{1}{2}$ "	1.65 Ea	5			#18B	\$ 8.50 Ea	
		#2-10 $\frac{3}{8}$ "x4 $\frac{3}{4}$ "	2.90 Ea	5			#18C	9.50 Ea	
1051	J-3		<b>RING CATCH</b> \$ 5.25 Ea	10			#18D	11.00 Ea	
1053	J-5		<b>SHIPS BOLT</b> \$ 7.60 Ea	5			#18E	15.00 Ea	
1055	H-5	#3- $\frac{3}{4}$ "	<b>STRUT</b> \$56.00 Ea				#18F	18.00 Ea	
		#5-1"	66.00 Ea				#19B	\$ 8.50 Ea	
		#6-1 $\frac{1}{8}$ "	66.00 Ea				#19C	9.50 Ea	
		#7-1 $\frac{1}{4}$ "	66.00 Ea				#19D	11.00 Ea	
1056	J-6		<b>ELBOW CATCH</b> \$ 3.20 Ea	10			#19E	15.00 Ea	
1056SP	J-6 & L-21		\$ 4.20 Card 50.40 Box	1 Pc 12 Cds			#19F	18.00 Ea	
1058	J-14	#1-2 $\frac{1}{4}$ " #2-3"	<b>HINGES</b> Pl Br Chrome \$ 1.55 Pr \$ 2.65 Pr 2.00 Pr 5.25 Pr	10 Pr 10 Pr	1098	K-3	#22B	\$ 8.50 Ea	
1065	J-5		<b>DOOR HOLDER</b> \$ 5.25 Ea	5 Sets			#22C	9.50 Ea	
1082	B-13, 16	#1 #2	<b>ELECTRIC ADAPTER</b> \$20.25 Ea 20.25 Ea				#22D	11.00 Ea	
1087	B-15	99A 99B 99C	<b>VAPORPROOF FIXTURE</b> \$ 34.00 Ea 17.50 Ea 4.50 Ea 7.70 Ea				#22E	15.00 Ea	
1088	H-3	#5-1" #6-1 $\frac{1}{8}$ " #7-1 $\frac{1}{4}$ "	<b>STUFFING BOXES</b> \$32.25 Ea 37.25 Ea 44.50 Ea				#22F	18.00 Ea	
1089	H-3	#4- $\frac{7}{8}$ " #5-1" #6-1 $\frac{1}{8}$ " #7-1 $\frac{1}{4}$ " #8-1 $\frac{3}{8}$ " #9-1 $\frac{1}{2}$ "	\$20.75 Ea 28.25 Ea 32.75 Ea 41.00 Ea 47.75 Ea 54.00 Ea				#22G	21.00 Ea	
1090	B-15	99A 99B 99C	<b>VAPORPROOF FIXTURE</b> \$ 39.00 Ea 17.50 Ea 4.50 Ea 7.70 Ea				#25B	\$ 8.50 Ea	
1098	K-3	#11-11 $\frac{1}{2}$ ' #15-15' #16-15' #18-18 $\frac{1}{2}$ ' #19-18 $\frac{1}{2}$ ' #22-22' #25-25'	<b>ALUMINUM OUTRIGGER POLES</b> \$35.00 Pr 45.00 Pr 67.50 Pr 93.50 Pr 105.00 Pr 125.00 Pr 170.00 Pr				#25C	9.50 Ea	
		99A- $\frac{1}{2}$ Pair 60% of above prices					#25D	11.00 Ea	
		#11A	\$ 7.50 Ea				#25E	15.00 Ea	
		#11B	8.50 Ea				#25F	18.00 Ea	
		#11C	9.50 Ea				#25G	21.00 Ea	
		#15A	\$ 7.50 Ea				#25H	26.00 Ea	
		#15B	8.50 Ea						
		#15C	9.50 Ea						
		#15D	11.00 Ea						
1100	K-9		<b>ROD HOLDER</b> \$11.00 Ea						
1101	J-3		<b>CUPBOARD BOLT</b> \$ 5.00 Ea	5					
1101SP	J-3 & L-20		\$ 5.85 Card 35.10 Box	1 Pc 6 Cds					
1102	J-3	#1 #2	<b>CUPBOARD CATCH</b> \$ 6.50 Ea 6.50 Ea	5 5					
1102SP	J-3 & L-20		\$ 8.40 Card 50.40 Box	1 Pc 6 Cds					
1103	J-7		<b>RING PULL</b> \$ 7.00 Ea	5					
1104	K-9		<b>ROD HOLDER</b> \$ 5.50 Ea						
1104SP	K-9 & L-24		\$ 7.40 Card 44.40 Box	1 Pc 6 Cds					
1106	J-16		<b>COAT HOOK</b> \$ 1.50 Ea	10					
1107	K-9		<b>SPARE BRACKETS</b> \$ 3.50 Pr						
1108	J-10	99A	<b>HATCH FASTENER</b> \$ 13.15 Ea 3.80 Ea	5					
1109	A-5, 11-14		<b>ELECTRIC SOCKET</b> \$ 1.15 Ea						
1110	J-16		<b>FLUSH PULL</b> \$ 4.10 Ea	5					
1112	J-10	99A	<b>HATCH FASTENER</b> \$12.70 Ea 3.80 Ea	5					
1112SP	J-10 & L-19		\$14.25 Card 42.75 Box	1 Pc 3 Cds					
1113	J-10	99A	\$12.70 Ea 3.80 Ea	5					
1113SP	J-10 & L-19		\$14.25 Card 42.75 Box	1 Pc 3 Cds					

Where Standard Packaging Not Indicated, Packaged Quantity Is One Unit.

Figure	Page	Size	List Price	Std. Pkg.	Figure	Page	Size	List Price	Std. Pkg.
1114	K-3	#18-18½'	<b>SPREADERS</b> \$110.00 Pr		1151B	B-4	#1	<b>MASTHEAD LIGHTS</b> \$125.00 \$179.00 \$198.00	
		#22-22'	125.00 Pr		1151RB	B-11	#1	125.00 179.00 198.00	
		#25-25'	125.00 Pr		1151MB	B-11	#1	125.00 179.00 198.00	
1115	K-3	#22-22'	\$200.00 Pr		1151C	B-11	#1	125.00 179.00 198.00	
		#25-25'	200.00 Pr		1151RC	B-11	#1	125.00 179.00 198.00	
1116	J-9	#1-8"	<b>WINDSHIELD ADJUSTER</b> \$11.40 Ea		1151MC	B-11	#1	125.00 179.00 198.00	
		#2-10"	12.00 Ea		1151B	B-4	#2	159.00 218.00 242.00	
		#3-12"	12.25 Ea		1151RB	B-11	#2	159.00 218.00 242.00	
		99A	3.50 Ea		1151MB	B-11	#2	159.00 218.00 242.00	
1117	J-8-9		<b>SPARE THUMB SCREW</b> \$ 1.50 Ea		1151C	B-11	#2	159.00 218.00 242.00	
1118	K-7		<b>FISHING ROD HOLDER</b> \$27.50 Ea		1151RC	B-11	#2	159.00 218.00 242.00	
1118SP	K-7 & L-24		\$30.75 Card 92.25 Box	1 Pc 3 Cds	1152B	B-4	#1	<b>STERN LIGHTS</b> \$125.00 \$179.00 \$198.00	
1120	A-5, 7, 11		<b>BRACKET ASSEMBLY</b> \$ 4.10 Ea		1152RB	B-11	#1	125.00 179.00 198.00	
1121	A-11		\$ 4.10 Ea		1152C	B-11	#1	125.00 179.00 198.00	
1122	A-7,11		4.10 Ea		1152RC	B-11	#1	125.00 179.00 198.00	
1134	A-7		<b>POLE LIGHT</b> \$12.70 Ea		1152MC	B-11	#1	125.00 179.00 198.00	
1136	J-8		<b>SPARE BASE</b> \$ 4.10 Ea		1152B	B-4	#2	159.00 218.00 242.00	
1137	A-7		<b>POLE LIGHT</b> \$12.70 Ea		1152RB	B-11	#2	159.00 218.00 242.00	
1138	J-8		<b>SPARE BASE</b> \$ 4.10 Ea		1152C	B-11	#2	159.00 218.00 242.00	
1140	B-8,15	#1 #2	<b>COVER GASKET</b> \$ .55 Ea .60 Ea		1152RC	B-11	#2	159.00 218.00 242.00	
1141	B-3		<b>SPARE CAP AND GASKET</b> \$15.75 Ea		1152MC	B-11	#2	159.00 218.00 242.00	
1142	B-3		<b>GASKET</b> \$ .60 Ea		1152MB	B-4	#1 #2	<b>TOWING LIGHTS</b> \$125.00 \$179.00 \$198.00 159.00 218.00 242.00	
1143	B-3		\$ 1.75 Ea		1153B	B-4	#1	<b>ALL-ROUND LIGHTS</b> \$125.00 \$179.00 \$198.00	
1144	A-7,11		<b>SPARE THUMB SCREW</b> \$ 1.75 Ea		1153C	B-11	#1	125.00 179.00 198.00	
1145	C-9		<b>SPARE COVER</b> \$ .50 Ea	5	1153B	B-4	#2	159.00 218.00 242.00	
1146	A-4	99A	<b>BOW LIGHT</b> \$ 9.65 Ea 1.15 Ea		1153C	B-11	#2	159.00 218.00 242.00	
1146SP	A-4 & L-2		\$11.00 Card 33.00 Box	1 Pc 3 Cds	1154RB	B-4	#1	\$125.00 \$179.00 \$198.00	
1147	C-9		<b>SPARE COVER</b> \$ .50 Ea	5	1154GB	B-4	#1	125.00 179.00 198.00	
1148	A-6		<b>POLE LIGHT</b> \$18.40 Ea		1154MB	B-4	#1	125.00 179.00 198.00	
1149	C-9		<b>SPARE GROMMET</b> \$ .30 Ea		1154RC	B-11	#1	125.00 179.00 198.00	
1150RB	B-4	#1	<b>SIDE LIGHTS</b> Galv PI Br Pol Br Each Each Each \$125.00 \$179.00 \$198.00		1154RB	B-4	#2	159.00 218.00 242.00	
1150GB	B-4	#1	125.00 179.00 198.00		1154GB	B-4	#2	159.00 218.00 242.00	
1150RC	B-11	#1	125.00 179.00 198.00		1154MB	B-4	#2	159.00 218.00 242.00	
1150GC	B-11	#1	125.00 179.00 198.00		1154RC	B-11	#2	159.00 218.00 242.00	
1150RB	B-4	#2	159.00 218.00 242.00		1154MB	B-4	#2	159.00 218.00 242.00	
1150GB	B-4	#2	159.00 218.00 242.00		1154RC	B-11	#2	159.00 218.00 242.00	
1150RC	B-11	#2	159.00 218.00 242.00		1155	I-18		<b>SPARE BEARING</b> \$ .20 Ea	%20
1150GC	B-11	#2	159.00 218.00 242.00		1156	A-7		<b>SPARE BASE</b> Pol Chr \$ 5.85 Ea	
					1157	A-10		<b>SPARE BRACKET</b> \$ 9.35 Ea	
					1158	A-11		<b>SPARE CAP</b> \$ 2.65 Ea	
					1160	B-4,11		\$15.75 Ea	
					1161	A-3		<b>BOW LIGHT</b> \$13.75 Ea	
					1164GB	B-3		<b>SIDE LIGHTS</b> \$278.00 Ea	
					1164RB	B-3		278.00 Ea	
					1165B	B-3		<b>MASTHEAD LIGHTS</b> \$278.00 Ea	
					1165RB	B-10		278.00 Ea	
					1165MB	B-10		278.00 Ea	
					1165RBL	B-10		278.00 Ea	
					1166B	B-3		<b>STERN LIGHTS</b> \$278.00 Ea	
					1166RB	B-10		278.00 Ea	
					1166MB	B-3		<b>TOWING LIGHT</b> \$278.00 Ea	

Where Standard Packaging Not Indicated, Packaged Quantity Is One Unit.

Figure	Page	Size	List Price	Std. Pkg.	Figure	Page	Size	List Price	Std. Pkg.
1166RBL	B-10		<b>ALL-ROUND LIGHTS</b>				6"	4.65 Ea	10
1167B	B-3		\$278.00 Ea				8"	9.00 Ea	5
1168GB	B-3		278.00 Ea		1188SP	I-3 & L-14	4"	\$ 9.30 Card	1 Pr
1168RB	B-3		278.00 Ea				6"	55.80 Box	6 Cds
1168MB	B-3		278.00 Ea					6.30 Card	1 Pc
1169B	B-3		166.00 Ea					37.80 Box	6 Cds
1169C	B-10		<b>ANCHOR LIGHT</b>		1189	C-9		<b>SNAP</b>	10
			\$166.00 Ea					\$ 8.75 Ea	
1170MB	B-3		<b>ALL-ROUND LIGHTS</b>		1190	C-9,E-8		<b>DECK CONNECTION</b>	10
1170RB	B-3		\$166.00 Ea		1190SP	C-9 & L-7		\$ 4.65 Ea	1 Pc
1170RC	B-10		166.00 Ea					\$ 5.50 Card	5 Cds
1170GB	B-3		166.00 Ea					27.50 Box	
1171RB	B-10		<b>DREDGE LIGHTS</b>		1191	C-9		<b>CABLE OUTLET</b>	10
1171RC	B-10		\$166.00 Ea					\$ 3.50 Ea	
1172RB	B-3		<b>SIDE LIGHTS</b>		1192	A-10		<b>GLARE SHIELD</b>	
1172GB	B-3		\$166.00 Ea					\$ 2.35 Ea	
1172RC	B-10		166.00 Ea		1194	J-17		<b>HASP</b>	10
1172GC	B-10		166.00 Ea		1194SP	J-17 & L-18	99A	\$ 3.80 Ea	1 Pc
								1.75 Ea	5 Cds
								\$ 4.85 Card	
								24.25 Box	
1173B	B-3		<b>MASTHEAD LIGHTS</b>		1195	A-10		<b>BOW LIGHTS</b>	
1173C	B-10		\$166.00 Ea		1196	A-10	#1-6"	\$32.25 Ea	
1173RB	B-10		166.00 Ea				#2-12"	\$16.90 Ea	
1173RC	B-10		166.00 Ea		1197	A-11		18.40 Ea	
1173MB	B-10		166.00 Ea					\$11.40 Ea	
1173MC	B-10		166.00 Ea		1198	J-17	#1-2"	<b>HASP</b>	10
							#2-3"	\$ 3.80 Ea	10
							#3-3 3/4"	4.00 Ea	10
1174B	B-3		<b>STERN LIGHTS</b>		1198SP	J-17 & L-18	#2	4.10 Ea	1 Pc
1174C	B-10		\$166.00 Ea					\$ 5.15 Card	12 Cds
1174RB	B-10		166.00 Ea					61.80 Box	
1174RC	B-10		166.00 Ea		1199	J-4	#1-1 3/4"	<b>DOOR HOOKS</b>	20
1174MC	B-10		166.00 Ea				#2-2 1/4"	\$ 2.10 Ea	20
							#3-3"	2.25 Ea	20
							#4-4"	2.35 Ea	20
1174MB	B-3		<b>TOWING LIGHT</b>		1199SP	J-4 & L-18	#1	2.45 Ea	1 Pc
			\$166.00 Ea					\$ 3.20 Card	12 Cds
1175	I-29		<b>SCRAPERS</b>	5				38.40 Box	
			\$ 4.10 Ea		1204	I-2	#2-3 1/2"	<b>CLEATS</b>	10
1176	I-27	#4-3/16"x1"	<b>BRASS PINS</b>	10			#3-5"	\$ 2.00 Ea	10
		#5-1/4"x5/8"	\$ .85 Ea	10			#4-6 1/2"	3.00 Ea	10
		#10-1/4"x1 1/4"	.85 Ea	10				4.00 Ea	10
		#15-3/16"x1 1/4"	\$ 1.00 Ea	10	1205	K-8		<b>ROD HOLDERS</b>	
		#27-1/2"x1 1/4"	1.10 Ea	10	1205SP	K-8 & L-24		\$10.65 Ea	1 Pc
			2.10 Ea	10	1206	K-8		\$10.60 Card	4 Cds
								42.40 Box	
								\$10.00 Ea	
1177	J-5		<b>DOOR STOP</b>	5	1209	A-7	#2-24"	<b>POLE LIGHTS</b>	
			\$ 2.00 Ea				#3-30"	\$30.00 Ea	
1178	A-14		<b>BOW LIGHT</b>				#4-36"	31.75 Ea	
			\$14.85 Ea				99A	33.25 Ea	
							99B	11.65 Ea	
1179	J-8	#1-10"	<b>ADJUSTERS</b>					4.10 Ea	
		#2-12"	\$16.65 Ea		1210	I-3	4"	<b>CLEATS</b>	10
1180	J-8	12"	16.95 Ea				6"	\$ 4.65 Ea	10
			\$16.90 Ea				8"	6.15 Ea	5
1181	A-11		<b>BOW LIGHTS</b>		1212	D-3		10.25 Ea	
1182	A-11		\$20.75 Ea					<b>FIXTURE</b>	
1183	A-11		\$20.75 Ea					\$ 8.50 Ea	
1184	A-11		\$15.50 Ea					.95 Ea	
			\$20.75 Ea					1.50 Ea	
1185	I-18		<b>ROWLOCK SOCKETS</b>	10 Pr	1213	J-13	#1-2 1/4"	<b>HINGES</b>	5 Pr
			Nat Chrome		1214	J-13	#1-2 1/4"	\$ 4.65 Pr	5 Pr
1186	I-18		\$ 2.35 Pr \$ 3.50 Pr	10 Pr				\$ 4.65 Pr	
1187	I-18		\$ 2.90 Pr \$ 5.25 Pr	10 Pr					
1188	I-3	4"	<b>CLEATS</b>	10					
			\$3.85 Ea						

Where Standard Packaging Not Indicated, Packaged Quantity Is One Unit.

# N-30

Figure	Page	Size	List Price	Std. Pkg.	Figure	Page	Size	List Price	Std. Pkg.
1215	A-4		<b>BOW LIGHT</b> \$13.15 Ea		1235	I-12	3"x3"	<b>BOW EYES</b> \$ 3.80 Ea	10
1216	J-5		<b>DOOR BUTTONS</b> \$ 2.75 Ea	10	1235SP	I-12 & L-16		\$ 5.00 Card 30.00 Box	1 Pc 6 Cds
1216SP	J-5 & L-21		\$ 3.65 Card 43.80 Box	1 Pc 12 Cds	1236	I-25		<b>FLANGE EYE</b> \$ 1.50 Ea	10
1216B	J-5		\$ 2.65 Ea	10	1237	I-5	#2½-5"x5"	<b>MOORING BITT</b> \$25.75 Ea	
1218	A-4		<b>BOW LIGHT</b> \$12.00 Ea		1238	F-6		<b>VENT</b> \$ 2.75 Ea	10
1218SP	A-4 & L-2		\$14.00 Card 42.00 Box	1 Pc 3 Cds	1242	I-31		<b>EYE STRAP</b> \$ .40 Ea	50
1219	I-5	#2½-5"x5"	<b>MOORING BITT</b> \$22.00 Ea		1243	I-30		<b>TILLER ROPE GUIDE</b> \$ 2.25 Ea	10
1220	J-7		<b>LIFT HANDLE</b> \$ 4.10 Ea	5	1245	H-7	99A	<b>GAS TANK CAP</b> \$ 5.55 Ea 4.40 Ea	5
1220SP	J-7 & L-20		\$ 5.25 Card 52.50 Box	1 Pc 10 Cds	1246	I-23		<b>FENDER HOOK</b> \$ 1.00 Ea	10
1222	I-15		<b>TRANSOM HANDLE</b> \$ 2.10 Ea	10	1246SP	I-23 & L-17		\$ 3.20 Card 38.40 Box	1 Pr 12 Cds
1223	I-10		<b>BOW CHOCKS</b> \$ 2.70 Pr	10 Pr	1248	H-8	#5,6 #7,8 #9 #10	<b>DECK PLATE KEYS</b> \$ .55 Ea .65 Ea .90 Ea 1.00 Ea	
1223SP	I-10 & L-15		\$ 4.25 Card 51.00 Box	1 Pr 12 Cds	1249	J-18		<b>LASHING HOOK</b> \$ .50 Ea	50
1224	I-19	#1 #2	<b>TRANSOM PADS</b> \$ 2.65 Pr 3.85 Pr	10 Pr 10 Pr	1249SP	J-18 & L-22		\$ 3.75 Card 37.50 Box	6 Pc 10 Cds
1224SP	I-19 & L-11	#1	\$ 4.20 Card 50.40 Box	1 Pr 12 Cds	1252	I-2		<b>CLEAT</b> \$ 4.65 Ea	5
1225	I-16	#0-8¾"x2¼" #1-8¾"x3¼" #2-11½"x5¾"	<b>STEP PLATES</b> \$ 3.20 Ea 4.10 Ea 8.50 Ea	10 10 10	1254	D-5		<b>FIXTURE</b> \$ 7.00 Ea	
1225SP	I-16 & L-13	#0 #1	\$ 8.15 Card 48.90 Box 10.15 Card 60.90 Box	1 Pr 6 Cds 1 Pr 6 Cds	1255	I-30	#2	<b>PULLEY</b> \$ 2.90 Ea	10
1226	I-31		<b>TILLER ROPE CLAMPS</b> Nat. Chrome \$ .60 Ea \$ .80 Ea	50	1256	I-30		<b>GUIDE</b> \$ .70 Ea	25
1226SP	I-31 & L-17		\$ 2.60 Card 31.20 Box	1 Pr 12 Cds	1257	I-10		<b>CHOCKS</b> \$ 3.00 Pr	10 Prs
1227	I-18		<b>ROWLOCK HORNS</b> Nat. Chrome \$ 2.45 Pr \$ 4.40 Pr	10 Pr	1261	I-30, J-4,17		<b>TILLER ROPE GUIDE</b> \$ .70 Ea	25
		99A	\$ .15 Ea	10	1262	I-18		<b>ROWLOCK HORNS</b> Nat. Chrome \$ 2.00 Pr \$ 3.80 Pr	10 Pr
1227SP	I-18 & L-11		Nat. Chrome \$ 3.60 Card \$ 5.50 Card 21.60 Box 33.00 Box	1 Pr 6 Cds	1262SP	I-18 & L-11		\$ 3.45 Card \$ 5.00 Card 20.70 Box 30.00 Box	1 Pr 6 Cds
1228SP	L-10		\$11.65 Card 69.90 Box	1 Pr 6 Cds	1263SP	L-10		\$11.20 Card 67.20 Box	1 Pr 6 Cds
1229	I-15		<b>TRANSOM HANDLES</b> \$ 1.85 Ea	10	1264	A-14		<b>SIDE LIGHTS</b> \$17.25 Pr 9.35 Ea 9.35 Ea 1.75 Ea 1.75 Ea	
1231	I-15		\$ 2.45 Ea	10	1264R				
1231SP	I-15 & L-13		6.60 Card 39.60 Box	1 Pr 6 Cds	1264G		99R 99G		
1232	I-12	¾"x3"	<b>BOW EYE</b> \$ 3.60 Ea	10	1265	A-14	99A	<b>BOW LIGHT</b> \$ 11.00 Ea 3.20 Ea	
1232SP	I-12 & L-16		\$ 4.75 Card 28.50 Box	1 Pc 6 Cds	1266	D-5 99A		<b>DOME LIGHT</b> Pi Br Chrome \$32.00 Ea \$43.00 Ea 3.80 Ea	
1234	I-14		<b>BOW HANDLE</b> \$ 3.50 Ea	10					

Where Standard Packaging Not Indicated, Packaged Quantity Is One Unit.



Figure	Page	Size	List Price	Std. Pkg.	Figure	Page	Size	List Price	Std. Pkg.
1267	I-18		<b>ROWLOCK HORNS</b> Nat. Chrome \$ 2.25 Pr \$ 4.10 Pr	10 Pr			BR#1-D.C. GD#1-D.C. WH#1-D.C.	\$ 9.50 Ea 9.50 Ea 9.50 Ea	
1267SP	I-18 & L-10		\$ 3.50 Card \$ 5.30 Card 21.00 Box 31.80 Box	1 Pr 6 Cds			BK#2-Med. Screw BR#2-Med. Screw GD#2-Med. Screw WH#2-Med. Screw	\$ 9.50 Ea 9.50 Ea 9.50 Ea 9.50 Ea	
1268SP	L-10		\$11.45 Card 68.70 Box	1 Pr 6 Cds					
1270	H-7	#1	<b>DECK PLATES</b> \$ 7.90 Ea		1304	D-3	BK#1-D.C. BR#1-D.C. GD#1-D.C. WH#1-D.C.	\$16.90 Ea 16.90 Ea 16.90 Ea 16.90 Ea	
1270B		99A	4.00 Ea				BK#2-Med. Screw BR#2-Med. Screw GD#2-Med. Screw WH#2-Med. Screw	\$16.90 Ea 16.90 Ea 16.90 Ea 16.90 Ea	
1270C		#1	7.90 Ea						
		99A	4.00 Ea						
		#1	7.90 Ea						
		99A	4.00 Ea						
1271	F-6		<b>VENT</b> \$ 3.00 Ea	10					
1275	F-7		<b>GASTANK CLAMPS</b> \$ 1.25 Ea	10	1305	I-6	#1-4 1/2" #2-6"	<b>CLEATS</b> \$ 2.70 Ea 4.65 Ea	
1287	J-4	#1-2" #2-2 1/2" #3-3"	<b>DOORHOOKS</b> \$ 2.10 Ea 2.25 Ea 2.35 Ea	20 20 20	1305SP	I-6 & L-14	#1 #2	\$ 7.00 Card 42.00 Box \$ 6.30 Card 37.80 Box	1 Pr 6 Cds 1 Pc 6 Cds
1287SP	J-4 & L-18	#2	<b>DOOR HOOK</b> \$ 3.20 Card 19.20 Box	1 Pc 6 Cds	1306	I-6	#1-4 1/2" #2-6"	<b>CLEATS</b> \$ 2.70 Ea 4.65 Ea	
1289	I-27		<b>SNAP</b> \$ 2.00 Ea	25	1306SP	I-6 & L-14	#1 #2	\$ 7.00 Card 42.00 Box \$ 6.30 Card 37.80 Box	1 Pr 6 Cds 1 Pc 6 Cds
1289SP	I-27 & L-22		\$ 2.80 Card 33.60 Box	1 Pc 12 Cds					
1290	J-8	99A 99B	<b>WINDSHIELD ADJUSTER</b> \$ 16.65 Pr 9.35 Ea 3.25 Ea		1307	I-8	#1-3 1/2" #2-5"	<b>BOW CHOCKS</b> \$ 3.50 Pr 6.35 Pr	
			1/2 Pr. Specify Port or Starboard		1307SP	I-8 & L-15	#1 #2	\$ 4.90 Card 58.80 Box \$ 7.85 Card 47.10 Box	1 Pr 12 Cds 1 Pr 6 Cds
1291	J-8	99A 99B	\$ 16.65 Pr 10.00 Ea 3.50 Ea		1308	I-8	#1-3 1/2" #2-5"	\$ 3.50 Pr 6.35 Pr	
			1/2 Pr. Specify Port or Starboard		1308SP	I-8 & L-15	#1 #2	\$ 4.90 Card 58.80 Box \$ 7.85 Card 47.10 Box	1 Pr 12 Cds 1 Pr 6 Cds
1292	A-9 J-8, 9		<b>SPARE KNOBS</b> \$ 1.50 Ea		1309	I-23		<b>FENDER HOOK</b> \$ 1.75 Ea	10
1293	J-12	#2-1 1/2x1 1/2 #3-2x1 1/2 #4-2x2 #5-2 1/2x2 #6-2 1/2x2 1/2 #7-3x3	<b>BUTT HINGES</b> \$ 4.50 Pr 4.65 Pr 4.75 Pr 5.00 Pr 5.55 Pr 6.15 Pr	5 Pr 5 Pr 5 Pr 5 Pr 5 Pr 5 Pr	1310	A-3		<b>BOW LIGHT</b> \$ 9.65 Ea	
1293SP	J-12 & L-19	#4	\$ 6.10 Card 61.00 Box	1 Pr 10 Cds	1310SP	A-3 & L-2		\$11.00 Card 66.00 Box	1 Pc 6 Cds
1295	D-2		<b>FIXTURE</b> Chrome \$ 5.95 Ea		1311	A-6	#2-24" #3-30" #4-36"	<b>POLE LIGHTS</b> \$12.00 Ea 12.75 Ea 13.75 Ea	
1297	I-20, J-8		<b>GRAB RAIL POSTS</b> \$ 2.10 Ea	4	1311SP	A-6 & L-4	#2	\$14.00 Card 70.00 Box	1 Pc 5 Cds
1298	I-20		\$ 2.10 Ea	2	1312	F-4		<b>VENT</b> \$ 6.75 Ea	
1299	I-23	99A	<b>FENDER LOCK</b> \$ 1.90 Ea 1.00 Ea	10	1312SP	F-4 & L-9		\$ 8.75 Card 35.00 Box	1 Pc 4 Cds
1299SP	I-23 & L-17		\$ 4.75 Card 57.00 Box	1 Pr 12 Cds	1313	H-7	99A	<b>GAS FILL</b> \$ 4.50 Ea 1.80 Ea	
1302	A-9		<b>FLAGSTAFF SOCKET</b> \$ 9.35 Ea		1313SP	H-7 & L-9		\$ 6.10 Card 36.60 Box	1 Pc 6 Cds
1303	D-3	BK#1-D.C.	<b>CABIN FIXTURES</b> \$ 9.50 Ea						

Where Standard Packaging Not Indicated, Packaged Quantity Is One Unit.

# N-32

Figure	Page	Size	List Price	Std. Pkg.	Figure	Page	Size	List Price	Std. Pkg.
1314	K-6		<b>OUTRIGGER POLE HOLDER</b> \$22.25 Pr		1407	I-9	#1-3½" #2-5"	<b>BOW CHOCKS</b> \$ 4.10 Pr 7.40 Pr	
1314SP	K-6 & L-24		\$24.50 Card 98.00 Box	1 Pr 4 Cds	1408	I-9	#1-3½" #2-5"	\$ 4.10 Pr 7.40 Pr	
1315	I-6	#1-4½" #2-6"	<b>CLEATS</b> \$ 3.50 Ea 5.25 Ea		1410	A-3		<b>BOW LIGHT</b> \$11.00 Ea	
1316	I-6	#1-4½" #2-6"	\$ 3.50 Ea 5.25 Ea		1415	I-7	#1-4½" #2-6"	<b>CLEATS</b> \$ 4.10 Ea 6.15 Ea	
1317	I-8	#1-3½" #2-5"	<b>BOW CHOCKS</b> \$ 5.00 Pr 7.30 Pr		1416	I-7	#1-4½" #2-6" #3-8"	\$ 4.10 Ea 6.15 Ea 8.60 Ea	
1318	I-8	#1-3½" #2-5"	\$ 5.00 Pr 7.30 Pr		1417	I-9	#1-3½" #2-5"	<b>BOW CHOCKS</b> \$ 5.85 Pr 8.50 Pr	
1320	K-6		<b>SPARE PLATE</b> \$ 6.00 Ea		1418	I-9	#1-3½" #2-5"	\$ 5.85 Pr 8.50 Pr	
1321	K-6		<b>SPARE TUBE</b> \$ 6.00 Ea		1505	M-3	#1-4½" #2-6"	<b>CLEATS</b> \$ 3.30 Ea 5.85 Ea	
1323	D-3,5		<b>SPARE SOCKET</b> \$ 1.20 Ea		1505SP	L-14	#1-4½" #2-6"	\$ 8.20 Card 49.20 Box	1 Pr 6 Cds
1325	I-16	#0-8¾"x2¼" #1-8¾"x3¼"	<b>STEP PLATES</b> \$ 3.20 Ea 4.10 Ea	10 10	1506	M-3	#1-4½" #2-6" #3-8"	\$ 7.50 Card 45.00 Box \$ 3.30 Ea 5.85 Ea \$ 8.50 Ea	1 Pc 6 Cds
1325SP	I-16 & L-13	#0	\$ 8.15 Card 48.90 Box	1 Pr 6 Cds	1506SP	L-14	#1-4½" #2-6"	\$ 8.20 Card 49.20 Box \$ 7.50 Card 45.00 Box	1 Pr 6 Cds
		#1	\$10.15 Card 60.90 Box	1 Pr 6 Cds	1510	M-2		<b>BOW LIGHT</b> \$12.00 Ea	
1330	A-6	#2-24" #3-30" #4-36" 99A	<b>POLE LIGHTS</b> \$20.25 Ea 21.00 Ea 22.00 Ea 7.00 Ea		1510SP	L-2		\$13.35 Card 80.10 Box	1 Pc 6 Cds
1330SP	A-6 & L-4	#2	\$22.25 Card 111.25 Box	1 Pc 5 Cds	1511	M-2	#2-24" #3-30" #4-36"	<b>STERN POLE LIGHT</b> \$13.50 Ea 14.25 Ea 15.25 Ea	
1331	A-14		<b>BOW LIGHT</b> \$ 9.65 Ea		1511SP	L-4	#2-24"	\$15.50 Card 77.50 Box	1 Pc 5 Cds
1332	A-15		<b>STERN LIGHT</b> \$ 9.65 Ea		1512	M-4		<b>COWL VENTILATOR</b> \$ 8.75 Ea	
1336	I-15		<b>TRANSOM HANDLE</b> \$ 3.20 Ea		1512SP	L-9		\$10.75 Card 43.00 Box	1 Pc 4 Cds
1336SP	I-15 & L-13		\$ 8.25 Card 49.50 Box	1 Pr 6 Cds	1513	M-4		<b>GAS FILL</b> \$ 6.25 Ea <b>SPARE CAP</b> 2.50 Ea	
1337	I-20		<b>GRAB RAIL ENDS</b> \$ 1.75 Ea		1513SP	L-9	99A	\$ 7.85 Card 47.10 Box	1 Pc 4 Cds
1338	I-20		<b>GRAB RAIL CENTERS</b> \$ 1.75 Ea		1515	M-3	#1-4½" #2-6"	<b>CLEATS</b> \$ 4.50 Ea 6.60 Ea	
1339	I-20	6'	<b>ALUMINUM TUBING</b> \$ 6.95 Lgth	5 Lgths	1516	M-3	#1-4½" #2-6" #3-8"	\$ 4.50 Ea 6.60 Ea 9.25 Ea	
1346	I-15		<b>TRANSOM HANDLE</b> \$ 4.10 Ea		1525	M-4	#0 #1	<b>STEP PLATES</b> \$ 3.50 Ea 4.50 Ea	10 10
1347	I-20		<b>GRAB RAIL ENDS</b> \$ 2.00 Ea		1525SP	L-13	#0 #1	\$ 8.75 Card 52.50 Box	1 Pr 6 Cds
1348	I-20		<b>GRAB RAIL CENTERS</b> \$ 2.00 Ea				#1	\$10.95 Card 65.70 Box	1 Pr 6 Cds
1350	D-3	#1-D.C. #2-Med. Screw	<b>FIXTURE</b> \$ 9.50 Ea 9.50 Ea						
1405	I-7	#1-4½" #2-6"	<b>CLEATS</b> \$ 3.00 Ea 5.30 Ea						
1406	I-7	#1-4½" #2-6" #3-8"	\$ 3.00 Ea 5.30 Ea 7.75 Ea						

Where Standard Packaging Not Indicated, Packaged Quantity is One Unit.

Figure	Page	Size	List Price	Std. Pkg.
1530	M-2	#2-24" #3-30" #4-36"	<b>STERN POLE LIGHTS</b> \$22.50 Ea 23.50 Ea 24.50 Ea	
1530SP	L-4	#2-24"	\$24.50 Card 122.50 Box	1 Pc 5 Cds
1901	E-5		<b>SEARCH LIGHTS</b> \$625.00 Ea	
1902	E-5		760.00 Ea	
1903	E-5		690.00 Ea	
1921	E-6		<b>CONTROL ASSEMBLIES</b> \$228.00 Ea	
1922	E-6		207.00 Ea	
6400	H-4	#4-1/4"-5/8" #10-3/8"-5/8" #12-5/8"-3/4" #16-3/4"-1" #20-1"-1 1/4" #28-1 1/4"-1 3/4" #36-1 3/4"-2 1/4" #44-2 1/4"-2 3/4" #52-3"-3 1/4" #56-3 1/4"-3 1/2" #64-3 1/2"-4"	<b>HOSE CLAMPS</b> \$ .70 Ea .85 Ea .85 Ea .85 Ea .90 Ea .90 Ea .95 Ea .95 Ea 1.00 Ea 1.00 Ea 1.05 Ea	10 10 10 10 10 10 10 10 10 10 10

**NOTES**

**NOTES**







**WE ARE MEMBERS OF THE FOLLOWING  
MARINE ASSOCIATIONS**



**NATIONAL ASSOCIATION OF ENGINE  
AND BOAT MANUFACTURERS**



**BOATING INDUSTRY ASSOCIATIONS**



**AMERICAN BOAT AND YACHT COUNCIL, INC.  
CHARTER MEMBER**



**THE PROPELLER CLUB OF THE  
UNITED STATES**



**MARINE RETAILERS ASSOCIATION  
OF AMERICA**

# **PERKO<sup>®</sup>**

**PERKO, INC., 16490 N.W. 13TH AVE., P.O. BOX 64000-D, MIAMI, FLORIDA 33164**