

# PERKO®

WE MAKE IT RIGHT. RIGHT HERE.

CATALOG NO. 265

1990-1991

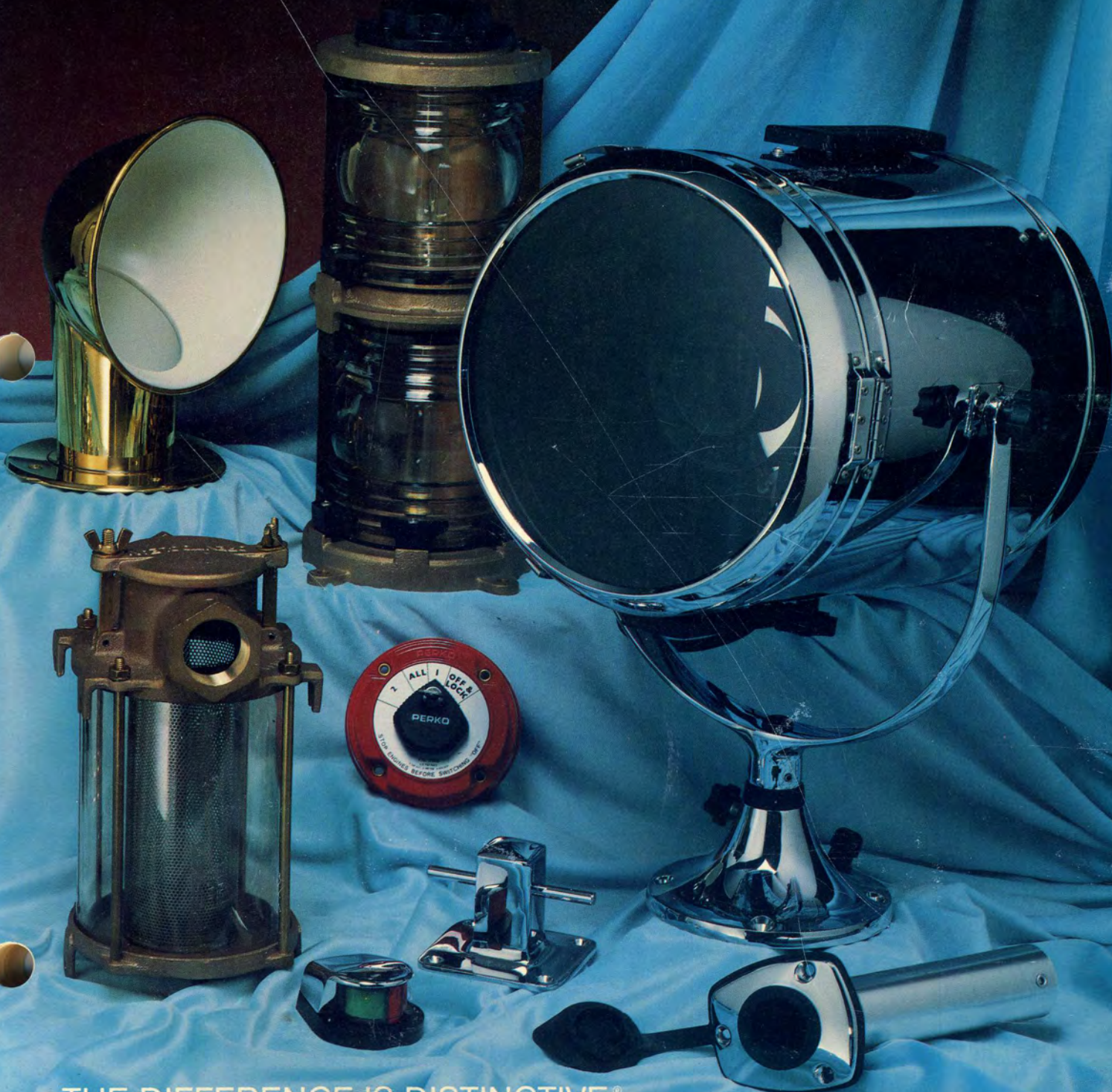

THE DIFFERENCE IS DISTINCTIVE®

# DISPLAY PACKAGING PROGRAM

Since the publication of our last catalog, we have greatly increased the number of products available in display package form. These attractive packages now make PERKO products easier to sell . . . and easier for the customer to buy.

Our commitment to better dealer/distributor sales and profits is backed by our continuing program of service and support. It's a PERKO PLUS!

As you look through this catalog you will find symbols next to those products that are Display Packed. The five styles of display packaging are illustrated below.



SKIN PACK

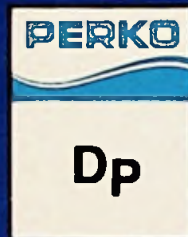

BAG

NEW



BLISTER PACK



BUBBLE PACK



BOX

# PERKO®

WE MAKE IT RIGHT, RIGHT HERE . . .

## CATALOG NO. 265 1990-1991

**Street Address**  
16490 Northwest 13th Avenue  
Miami, Florida 33169-5707

**Mailing Address**  
P.O. Box 64000  
Miami, Florida 33164-0510

**Telephone Number**  
(305) 621-7525

**Fax Number**  
(305) 620-9978

© PERKO, INC. 1990  
ALL RIGHTS RESERVED

PORTIONS OF THIS CATALOG  
PREVIOUSLY COPYRIGHTED IN  
1936-1989 INCLUSIVE

THE DIFFERENCE IS DISTINCTIVE®

MANUFACTURER OF  
SHIP AND BOAT EQUIPMENT

**NAVIGATION LIGHTS FOR  
VESSELS UNDER 20 METERS**  
**1-38**

**NAVIGATION LIGHTS FOR  
VESSELS OVER 20 METERS**  
**39-48**

**SEARCHLIGHTS**  
**49-68**

**ELECTRIC SWITCHES  
LIGHTING FIXTURES  
BULBS**  
**69-86**

**VENTILATORS  
VENTS, BELLS**  
**87-94**

**PIPE & HOSE DECK PLATES  
UNDERWATER FITTINGS  
STRAINERS, FILTERS**  
**95-114**

**DECK HARDWARE, CLEATS  
CHOCKS, BITS, BOW EYES  
ROWLOCKS, WINDSHIELD &  
HATCH ADJUSTERS**  
**115-150**

**CABINET & DOOR  
HARDWARE, LOCKS  
HINGES, HOOKS, ETC.**  
**151-180**

**FISHING  
EQUIPMENT**  
**181-192**

# PERKO, INC.

16490 N.W. 13th AVENUE  
MIAMI, FL 33169-5707

MAIL: P.O. BOX 64000-D  
MIAMI, FL 33164-0510

PHONE: (305) 621-7525  
FAX: (305) 620-9978

MARVIN S. PERKINS  
PRESIDENT

## To Our Friends:

It is with a great deal of pleasure that we present this 1990-91 edition of your PERKO Catalog. You will note many new products and many products added to our Display Package Program.

In total, I think you will agree, "The difference is distinctive"® . . . as are all PERKO products.

Since the late 1800s, we have been manufacturing marine lights, hardware and accessories in our factories, to exacting standards of quality and performance. In fact, our **made in the U.S.A.** products have become the world standard for premium quality and performance in the marine industry . . . we make it right, right here.

All PERKO products are designed to retain their original appearance and characteristics over long use, and carry a limited one-year warranty. In addition, any product finished with our exclusive PERKOPLATE chromium plating process or PERKO•KOTE powder coating process carries a lifetime warranty insuring the original finish for as long as the initial consumer-purchaser owns it. (See complete warranty, page XII.)

As you look over this catalog, feel free to call on us with any questions you may have. Our entire staff is dedicated to providing you, our customers, with service and performance for what you need, when you need it.

You can count on our commitment to excellence . . . it's a PERKO plus!

Sincerely,

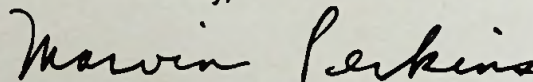

Marvin Perkins  
President

MANUFACTURER OF MARINE LIGHTS, HARDWARE AND ACCESSORIES

# The Perko Story

The PERKO story is really many interesting pieces that make up a modern day marine hardware success story . . . going back over 100 years!

Started by Frederick Perkins in a small plant in lower Manhattan, New York in the late 1880s, four generations later PERKO is still a privately owned, family operated corporation . . . very unusual for a company our size in today's marketplace. Now housed in a modern facility of over 300,000 square feet in North Miami, Florida, family control allows us to quickly respond to customer and market needs, and our business philosophy has always emphasized long term commitment to quality leadership in the marine industry.

Our employees are an integral part of our business family, and they take personal pride in providing individual attention to what they do, and how they do it. Their friendly, positive attitude is in part based on the fact that no piece work is performed in any of our operations. All employees are paid on an hourly basis . . . which eliminates a great deal of pressure, and also allows each worker the time to properly inspect PERKO products as they are being produced. Everyone concentrates on customer satisfaction.

The company Frederick Perkins started was known as Perkins Marine Lamp, Inc., and the original focus was on the manufacture of hand formed sheet metal products for the marine market. These ship navigation lights, cowl ventilators, chart cases and other hand formed items fabricated from brass, copper and galvanized sheet metal began what was to become our ongoing reputation for high quality products. Today, we still do hand forming and soldering much as it was done in our early years.

In 1907, Louis Perkins joined his



FREDERICK PERKINS



LOUIS E. PERKINS

## Co-founders

father in the business, and together they enlarged both the line of products and the facilities to house the expansion. By 1932, the company name was changed to Perkins Marine Lamp and Hardware Corporation, to better reflect what was then being offered.

In 1922, the "PERKO" trademark was instituted. Each new product, and there were many, utilized the latest sophisticated metal manufacturing technology, and customers came to expect the highest standards of excellence from PERKO products.

As our reputation increased, the company enjoyed exceptional growth into the 1930s, and new manufacturing facilities were added. Under the direction of Lou Perkins, the original one story plant grew to five stories, and then to six more buildings. By the time Frederick Perkins died in 1947, PERKO had become a major factor in the fast growing marine industry.

At Frederick's passing, Louis Perkins became president. His son, Marvin, now president of PERKO, joined the company in 1947. With the passing of Louis Perkins in 1964, Marvin assumed the top

responsibilities and continued the growth and innovation that exists to this day.

Fred Perkins, Marvin's older son, entered the family business in the late 1960s, and quickly established himself as one of the marine industry's most knowledgeable authorities on navigational light requirements. Marvin's younger son, David Perkins, officially joined PERKO in 1981, and his considerable people skills have been a real asset to the company as sales/service coordinator.

Roy Hollenbeck came on board in 1960 to plan and coordinate the company move from Brooklyn, N.Y. to North Miami, Florida, which took place in 1961. Roy's extensive experience in manufacturing, plating, engineering, designing and production was instrumental in our successful move from a number of separate plants in N.Y. to one large plant with all of our facilities under one roof.

Today, PERKO is truly an integrated manufacturer, almost completely independent of outside vendors, with the exception of a few basic items such as light bulbs, electric wire, etc. A whole range of

complete in-house capabilities, from product design through manufacturing and assembly of finished products, enabled us to eliminate most subcontractors and obtain better control of our product quality, cost and delivery.

Throughout all of our operations, steps have been taken to efficiently assure production of the highest quality products. Our products are designed and manufactured to meet or exceed UL, NMMA, IM-MCO and other industry standards . . . and our own quality specifications. Quality control is consistently maintained and every step forward, from our founding to the present day, has been undertaken with our customer in mind. Each PERKO product is thoroughly evaluated for safety, appearance and function.

Once we were settled in Florida, in 1961, we established our own bronze factory. By 1965, a 47,000 square foot extension was completed to house the sophisticated die-casting systems that now produces zinc and bronze parts.

PERKO is the only **marine manufacturer** producing die-cast bronze parts . . . which are well

known for strength, uniformity, and high quality. As the 1960s ended, PERKO introduced pressure cast bronze hardware to the marine industry . . . another first.

Our sand casting foundries help us control the production of our high quality brass, bronze and aluminum castings, and offers assurance that the proper alloy is used for each job.

Our diverse press department utilizes a variety of forming tools, including multi-stage progressive tooling produced in our toolroom. Our large, conventional machine shop includes many secondary operations such as drilling, tapping and assembly. A separate machine shop houses a number of modern high speed automatic chuckers for high volume items, and our three separate polishing divisions assure the correct finishing procedure for each product.

Over the last two years, our plating plant has been completely redesigned and rebuilt into a state-of-the-art facility. Special automated controls insure the complete seven-strike chromium plating process which makes it possible to offer a

lifetime warranty on our well known PERKOPLATE finish.

In 1979, a 35,000 square foot plastics injection molding facility was added to enable us to produce all of our own plastic products and components for electric sockets, lenses, etc.

We have a number of IBM computers, one of which is coupled with scanning devices to control inventory and shipments against orders. Our in-house printing and graphics department produces almost all of our printed materials . . . from labels to sales bulletins. In total, careful planning over the years has enabled us to become virtually self-sufficient in every department.

It has always been our objective to provide our customers with the very best in marine lights, hardware and accessories at competitive prices. The marketplace has rewarded our emphasis on quality with ever increasing sales and reputation. Designed and built to the highest specifications, all PERKO products are backed with outstanding warranties and our commitment to excellence. It's a PERKO plus you can count on!

---

## OUR MODERN SELF-CONTAINED FACILITY



# General Information

## SALES POLICY

PERKO Products are sold through our established Distributors. We do not sell direct to the public or organizations. Therefore, possession of this catalog does not infer an offer to sell. Please contact your local marine supplier.

## PRICES AND TERMS

Our costs are subject to change due to causes beyond our control. Therefore, our price list is only intended for the guidance of our customers and does not necessarily establish resale prices. Applicable governmental regulations, shipping costs and other complications should be considered in arriving at a fair price. *A Repackaging Service Charge of \$5.00 net will apply to all broken packages.* All prices are subject to change without notice. Terms are 2% 10th Prox., net 30 days.

Orders from firms unknown to us and having no satisfactory commercial credit rating must be accompanied by cash or satisfactory references. C.O.D. shipments will be made if a 25% deposit is sent with order. Cash discounts do not apply to C.O.D. shipments.

## ONE YEAR LIMITED WARRANTY

PERKO, INC. (PERKO) warrants to the original consumer-purchaser that PERKO's consumer products will be free from defective materials or workmanship, under normal use and service, for a period of one (1) year from the original purchase date.

ALL IMPLIED WARRANTIES, INCLUDING MERCHANTABILITY, ARE ALSO LIMITED IN DURATION TO THE ONE YEAR PERIOD FROM THE ORIGINAL PURCHASE DATE. PERKO SHALL NOT BE LIABLE FOR LOSS OF USE OF ANY OF ITS CONSUMER PRODUCTS, NOR SHALL PERKO BE LIABLE FOR OTHER INCIDENTAL OR CONSEQUENTIAL COSTS, EXPENSES, OR DAMAGES INCURRED BY THE ORIGINAL CONSUMER-PURCHASER OR BY ANY OTHER PERSON, FIRM OR CORPORATION.

SOME STATES DO NOT ALLOW LIMITATIONS ON HOW LONG AN IMPLIED WARRANTY LASTS, SO THE ABOVE LIMITATION MAY OR MAY NOT APPLY TO YOU. SOME STATES DO NOT ALLOW THE EXCLUSION OR LIMITATION OF INCIDENTAL OR CONSEQUENTIAL DAMAGES, SO THE ABOVE LIMITATION OR EXCLUSION MAY NOT APPLY TO YOU.

This Warranty is void if the consumer product warranted has been damaged by accident or unreasonable use, neglect, improper service or other cause not arising out of defects in material or workmanship. Excluded from this Warranty are Electric light bulbs (Lamps), Sealed Beam Units, and Fuses.

During the warranty period, your PERKO product will either be repaired or it will be replaced with a like product (at PERKO's option) without charge to the original consumer-purchaser, when returned prepaid and insured, with proof-of-purchase date to PERKO at our factory in Miami, FL. In the event of replacement, the replacement product will continue the warranty of the original product, or ninety (90) days, whichever is longer. **IMPORTANT: FOR THIS WARRANTY TO BE EFFECTIVE PERKO MUST BE SUPPLIED WITH PROOF-OF-PURCHASE DATE OF THE PRODUCT.**

PERKO does not authorize any person or company to create for it any other obligation or liability in connection with any of its products.

This warranty gives you specific legal rights, and you may also have other rights which vary from state to state.

## DESIGNS

For the purpose of constant improvement in our products, the designs and specifications are subject to change without notice.

## RETURN GOODS

Material made to order is not returnable. Stock material is only

returnable when permission has been granted by us, and is subject to a handling and refinishing charge. Shipping charges must be prepaid. Be sure to give date and number of invoice. Permission must be requested within 30 days after receipt of material.

## WEIGHTS

The weights given in this catalog are approximate, but should be sufficient for general purposes.

## SHIPPING INSTRUCTIONS

Customers should send specific shipping instructions; if this is not done, we will use our own judgment in selecting route.

## SHIPMENTS

F.O.B. OUR PLANT, MIAMI, FLORIDA, unless quoted otherwise. We are not responsible for damage, loss or delay after goods are delivered to carrier. When loss or delay occurs, we will gladly assist in tracing or expediting, but such assistance is no criterion of responsibility.

When there is LOSS OR APPARENT VISIBLE DAMAGE to a shipment, when tendered for delivery, DO NOT give the carrier a clear receipt. Note such damage on the carrier's delivery receipt and HAVE THE DRIVER SIGN THE RECEIPT.

## CONCEALED DAMAGE OR LOSS

1. Advise the delivering carrier in writing as soon as discovered or at least no more than 15 days after delivery, and request carrier to make an inspection.
2. RETAIN for the carrier's inspection, the CONTAINER and ALL PACKING that the damaged or lost material was packaged in.
3. SHORTAGES — Must be reported to us within 15 days after receipt of goods.

# Modern Facilities

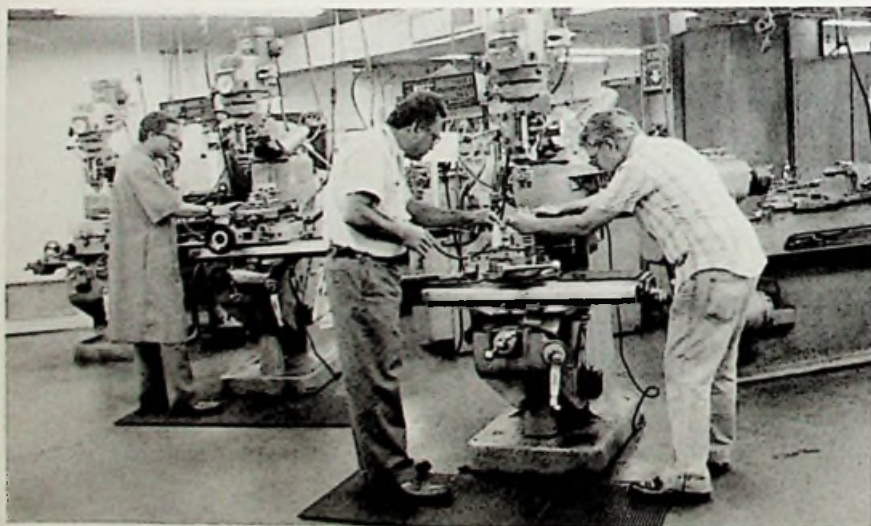
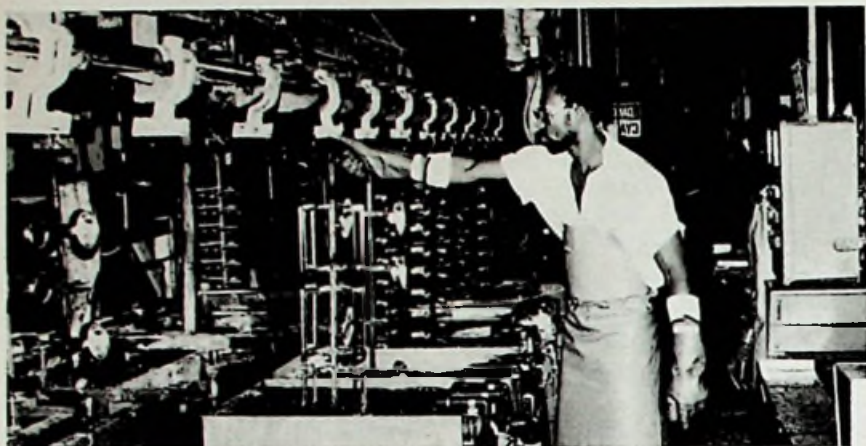



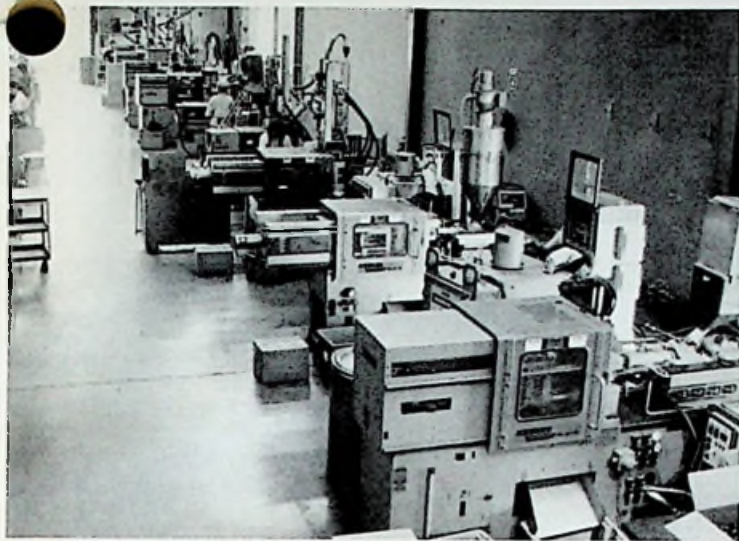

Top Left — PERKOPLATE Plating Department  
Center Left — Quality Control Lab, Atomic Absorption Apparatus  
Bottom Left — Tool and Die Department

Top Center — New Computerized CNC Machining Center  
Center Right — Ultrasonic Bonding of Navigation Light Lenses

Top Right — Plastic Injection Molding Department  
Bottom Right — Searchlight Department

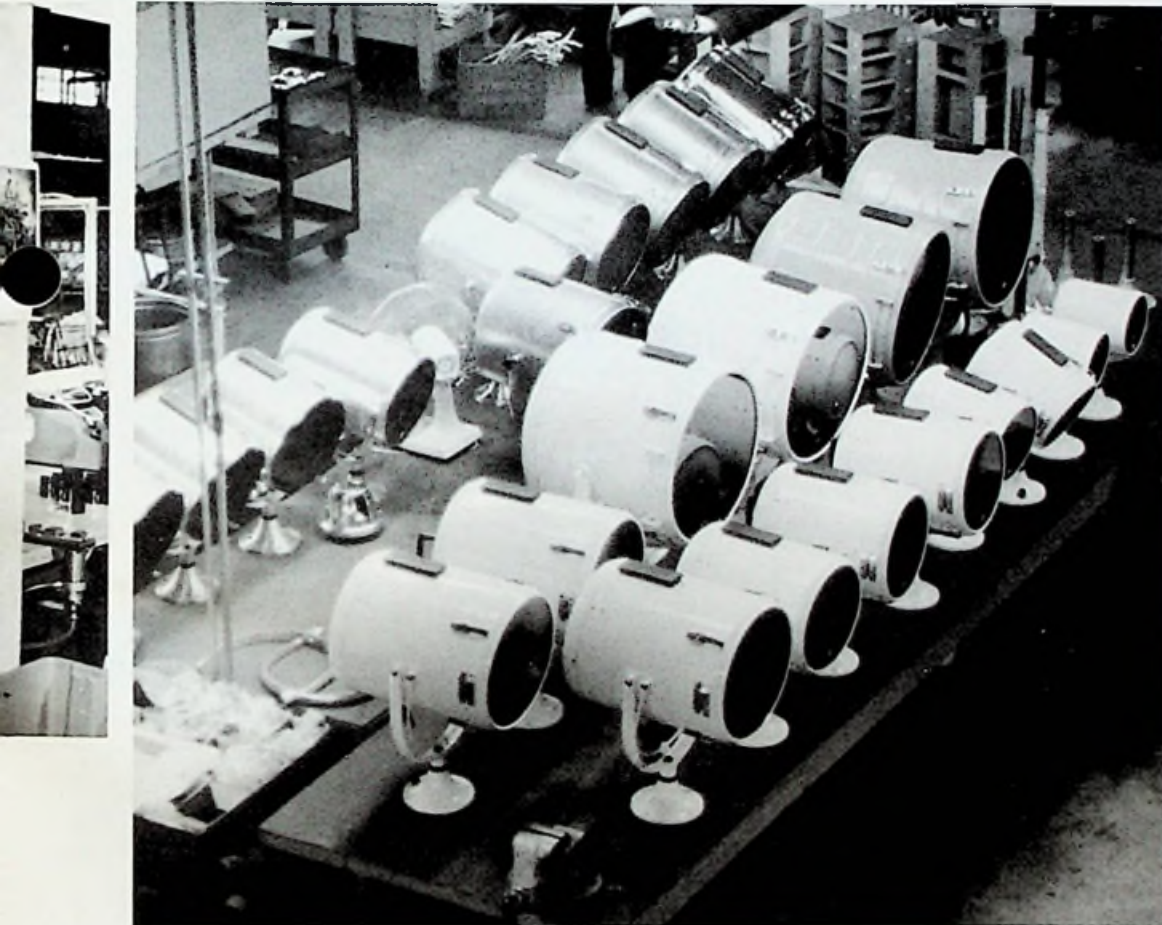

# Our People

## Officers

(L) MARVIN S. PERKINS  
President



(R) LEROY S. HOLLENBECK  
Executive Vice President



(L) FREDERICK M. PERKINS  
Corporate Secretary



(R) ALLEN W. MATTHEWS, JR.  
Vice President — Marketing



(L) JOHN P. RUSH  
Asst. Vice President — Marketing



(R) K. TIMOTHY LePAGE  
Vice President — Purchasing



(L) MIKE ANGELONE  
Vice President — Data Processing



(R) ALBERT M. FREMONT  
Treasurer



## Staff

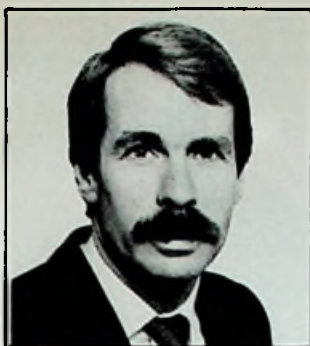

(L) REGINALD ULLMANN  
Sales Mgr. — OEM Division

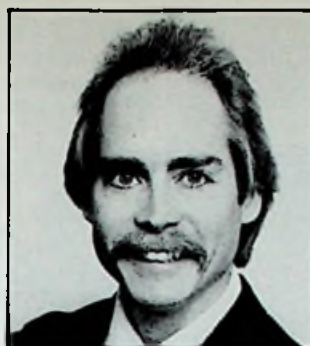

(R) JIM FORD  
Sales/Service Coordinator



(L) LINDA SYKES  
Customer Service



(R) RICHARD KURZ  
Customer Service



(L) GAIL MALLY  
Customer Service



(R) CARLENE THOMSON  
Customer Service

## Export Division



(L) JOSE R. MARTINEZ  
Sales Mgr. — Export Division



(C) ROSA FLORES  
Export Service



(R) KEITH W. HEWITT  
Exclusive European Sales Agent  
Penvic Marine Limited  
32 Copperfields — Totton  
Southampton Hampshire SO42FL  
England  
Tele: (44) 703 870341  
Fax: (44) 703 663156

# REGIONAL SALES REPRESENTATIVES

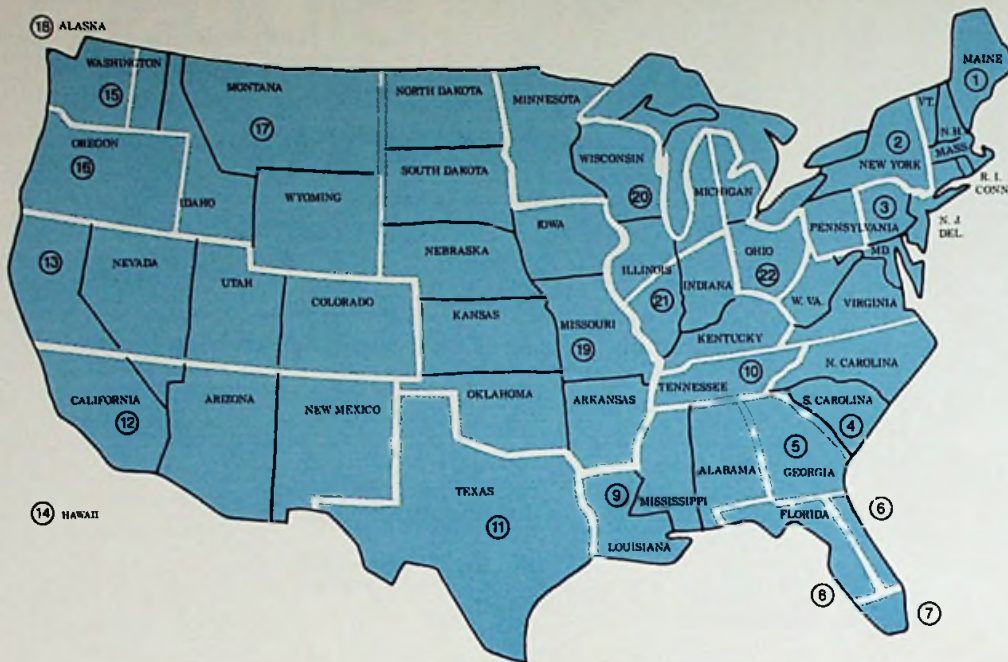

**(1) MAINE, MASS., NEW HAMPSHIRE, RHODE ISLAND, CONNECTICUT**  
 Carswell, Gallagher, Williams Associates  
 137 Brandt Island Rd.  
 Mattapoisett, MA 02739  
 Phone 508-758-2980/Fax 508-758-9705  
**WAYNE OLIVIERA**



**(4) NORTH & SOUTH CAROLINA**  
 Henry S. Gartner & Associates, Inc.  
 2419 Tram Road  
 New Bern, NC 28560  
 Phone 919-633-1210  
 Fax 919-633-1692  
**KEN WILLIAMS**

**(1) MAINE, MASS., NEW HAMPSHIRE, RHODE ISLAND, CONNECTICUT**  
 Carswell, Gallagher, Williams Associates  
 354 Country Way/P.O. Box 414  
 Scituate, MA 02066  
 Phone 617-545-3790/Fax 617-545-0359  
**CHARLES W. O'CONNOR**



**(5) GEORGIA**  
 Henry S. Gartner & Associates, Inc.  
 6545 Lake Meadow Dr.  
 Hixson, TN 37347  
 Phone 615-843-3556  
 Fax 615-843-3555  
**ROBERT TAYLOR**

**(2) N.Y. STATE, W. PENN., CENTRAL & EASTERN CANADA**  
 Ed Sheldon & Associates, Inc.  
 4280 St. Paul Blvd.  
 Rochester, NY 14617  
 Phone 716-467-7369  
**EDWARD J. SHELDON**



**(6) EASTERN & CENTRAL FLORIDA**  
 Henry S. Gartner & Associates, Inc.  
 6082 Westgate Dr./Suite 204  
 P.O. Box 617289  
 Orlando, FL 32811  
 Phone 407-292-5162/Fax 407-292-5164  
**TRIPP HAMMACK**

**(2) N.Y. STATE, W. PENN., CENTRAL & EASTERN CANADA**  
 Ed Sheldon & Associates, Inc.  
 12 Cranswick Lane  
 Rochester, NY 14618  
 Phone 716-381-6845/Fax 716-385-6928  
**CHARLES KUIMJIAN**



**(7) SOUTHERN FLORIDA**  
 Henry S. Gartner & Associates, Inc.  
 2470 N.E. 22 Street/P.O. Box 50227  
 Lighthouse Point, FL 33064  
 Phone 305-781-4303  
 Fax 305-781-4412  
**JACK BARNES**

**(3) LONG ISLAND-NY, NJ, VA, DE, MD, E. PENN.**  
 John Bergbauer & Associates  
 2201 Asbury Ave./P.O. Box 887  
 Ocean City, NJ 08226  
 Phone 609-398-7033/Fax 609-398-3117  
**JOHN BERGBAUER**



**(7) SOUTHERN FLORIDA**  
 Henry S. Gartner & Associates, Inc.  
 2470 N.E. 22 Street/P.O. Box 50227  
 Lighthouse Point, FL 33064  
 Phone 305-781-4303  
 Fax 305-781-4412  
**JAY BARNES**

**(3) LONG ISLAND-NY, NJ, VA, DE, MD, E. PENN.**  
 John Bergbauer & Associates  
 46 Jayne Ave.  
 Patchogue, NY 11772  
 Phone 516-758-9834  
**PETER BODKIN**



**(8) WESTERN & CENTRAL FLORIDA**  
 Henry S. Gartner & Associates, Inc.  
 8300 Ulmerton Road/Suite A18F  
 Largo, FL 34641  
 Phone 813-535-2833  
 Fax 813-531-8219  
**BRUCE WEBER**

(9) LOUISIANA, ALABAMA, MISS.  
MAC-HUGH & Associates, Inc.  
5540 Pepsi Street  
Harahan, LA 70123  
Phone 504-734-9411  
Fax 504-734-5144  
KYLE McHUGH



(15) W. WASH., BRITISH COLUMBIA,  
ALBERTA, S.E. ALASKA  
Merifield Co., Inc.  
927 N.W. 50th St./P.O. Box 70626  
Seattle, WA 98107  
Phone 206-789-1800/Fax 206-783-7669  
JON EDWARDS

(9) LOUISIANA, ALABAMA, MISS.  
MAC-HUGH & Associates, Inc.  
5540 Pepsi Street  
Harahan, LA 70123  
Phone 504-734-9411  
Fax 504-734-5144  
BUZZ HUMPHREY



(16) OREGON, W. IDAHO  
Merifield Co., Inc.  
10325 S.W. 57th Pl.  
Portland, OR 97219  
Phone 503-244-6451  
Fax 503-245-7224  
JERRY LANAHAN

(10) TENNESSEE  
MAC-HUGH & Associates, Inc.  
Route 2, Box 381  
Maryville, TN 37801  
Phone 615-982-1150  
TOM GAVLICK



(17) E. IDAHO, MONTANA,  
E. WASH., WYOMING  
Merifield Co., Inc.  
N. Houk Court #16  
Spokane, WA 99216  
Phone 509-922-4818/Fax 509-922-3564  
TERRY HECKEL

(11) TEXAS  
MAC-HUGH & Associates, Inc.  
1511 Lake Bank Court  
Seabrook, TX 77586  
Phone 713-326-3291  
HUGH W. MULHOLLAND



(18) CENTRAL & NO. ALASKA  
Merifield Co., Inc.  
750 W. Dimond/Suite 201  
Anchorage, AK 99515  
Phone 907-344-3825  
Fax 907-349-7612  
BRUCE FRIEND

(12) S. CAL., NV, AZ, NM  
Dugan & Associates, Inc.  
18211 Enterprise Lane/Unit E  
Huntington, CA 92646  
Phone 714-841-1428  
Fax 714-841-0480  
DAN A. NABOR



(19) MISSOURI, KANSAS, IOWA,  
NO. & SO. DAKOTA, OK, NE, & ARKANSAS  
Midwestern Sales Co., Inc.  
9849 Briar Drive  
Overland Park, KS 66207  
Phone 913-649-1270/Fax 913-649-2707  
DENNIS WILLS

(13) N. CAL., UTAH, COLORADO  
Dugan & Associates, Inc.  
3368 McGraw Road  
Lafayette, CA 94549  
Phone 415-284-4855  
Fax 415-284-4856  
WAYNE R. MOOERS



(20) N. ILLINOIS, N. INDIANA, W. MICHIGAN  
Inland Marketing Associates, Inc.  
601 Franklin Square/P.O. Box 680  
Michigan City, IN 46360  
Phone 219-879-2707  
Fax 219-879-5224  
EARL HENDERSON

(14) HAWAII  
Dugan & Associates, Inc.  
632 Auwina Street  
Kailua, HI 96734  
Phone 808-262-2777  
Fax 808-262-2775  
MICHAEL D. MORELLI



(20) N. ILLINOIS, N. INDIANA,  
MINNESOTA, WISCONSIN  
Inland Marketing Associates, Inc.  
730 N. Waukegan Rd./P.O. Box 325  
Deerfield, IL 60015  
Phone 708-945-0545/Fax 708-945-0561  
WM. D. GREENE

(15) W. WASH., BRITISH COLUMBIA,  
ALBERTA, S.E. ALASKA  
Merifield Co., Inc.  
927 N.W. 50th St./P.O. Box 70626  
Seattle, WA 98107  
Phone 206-789-1800/Fax 206-783-7669  
TOM HARGER



(21) S. ILLINOIS, S. INDIANA  
KENTUCKY, W. MICHIGAN  
Inland Marketing Associates, Inc.  
1071 Highland Ct./P.O. Box 414  
Plymouth, IN 46563  
Phone 219-936-6972/Fax 219-936-8248  
ED KUYKENDALL

(15) W. WASH., BRITISH COLUMBIA,  
ALBERTA, S.E. ALASKA  
Merifield Co., Inc.  
927 N.W. 50th St./P.O. Box 70626  
Seattle, WA 98107  
Phone 206-789-1800/Fax 206-783-7669  
IVAN CROSS



(22) E. MICHIGAN, OHIO  
Inland Marketing Associates, Inc.  
500 S. Washington/Suite 11  
Royal Oak, MI 48067  
Phone 313-541-4404  
Fax 313-541-4405  
R. WILLIAM BURT

# PERKOPLATE/PERKO•KOTE LIMITED WARRANTY

PERKO, Inc. guarantees that all of its products finished with the PERKO-PLATE chromium plating process will maintain their original luster and brightness, or those finished with the PERKO•KOTE powder coating process will remain corrosion-free for as long as the original consumer-purchaser owns them. During the Warranty period, PERKO, Inc. agrees to repair or replace, (at PERKO's option) without cost to the original consumer-purchaser, any product upon which the PERKOPLATE chromium finish corrodes, becomes dull or otherwise does not maintain its original luster and brightness, or any product upon which the PERKO•KOTE finish corrodes. For this Warranty to be effective, the PERKO product must be returned prepaid and insured to PERKO, Inc. at its address shown below.

This Warranty is void if the PERKO-PLATE or PERKO•KOTE finish has been damaged by accident unreasonable use, neglect, improper service or other cause not arising out of defects in material or workmanship.

IN NO EVENT SHALL PERKO, INC. BE LIABLE FOR LOSS OF USE OF ITS CONSUMER PRODUCTS NOR FOR OTHER INCIDENTAL OR CONSEQUENTIAL COSTS, EXPENSES, OR DAMAGES INCURRED BY THE INDIVIDUAL. Some states do not allow the exclusion or limitation of incidental or consequential damage, so the above limitation may not apply to you. This Warranty gives you specific legal rights, and you may also have other rights which vary from state to state.

PERKO, Inc.  
16490 N.W. 13th Avenue  
Miami, Florida 33169-5707

**PERKO®**  
WE MAKE IT RIGHT . . . RIGHT HERE

---

## CERTIFICATION OF NAVIGATION LIGHTS FOR VESSELS UNDER 20 METERS (65.6 ft.) IN LENGTH

### BACKGROUND (U.S.A.)

The National Marine Manufacturers Association (NMMA) is a trade association serving all elements of the recreational boating industry. It has developed certification programs to help manufacturers comply with established standards, safety regulations and help inform the public of such compliance when purchasing equipment.

In 1968 NMMA inaugurated a certification program for boat manufacturers including horsepower, load capacity, floatation, steering systems, fuel systems, compartment ventilation, *navigation lights* and backfire flame control. A manufacturer participating in this program must certify all models (except racing boats) as fitted with standard equipment on a model year basis. Inspectors from a nationally recognized independent testing laboratory then visit the manufacturer, and physically inspect each model for compliance *with all* boat certification standards.

During the past several years we have devoted a great deal of time and expense to field and laboratory testing in order to comply with NMMA standards and to enable us to certify accordingly.

### PRESENT (U.S.A.)

Currently, federal regulations for navigation lights on vessels under 20 meters are split. The U.S.C.G. regulates and enforces the configuration and carriage of lights on the vessel, but industry standards regulate the design, manufacture, and certification of the lights. At this moment, the *only* means of certification widely recognized in the United States is through the NMMA program discussed above.

It is important to note that navigation lights can be tested and certified to meet the '72 COLREGS in a foreign country, however, each country has its own testing and certification procedure, which differs from the U.S. procedure. This means that a navigation light certified to meet the '72 COLREGS may be referring to approvals granted by another government, and can not be recognized by the U.S.C.G. for U.S. vessels until such time as the light passes the U.S. standards. At this time, our government has no plans to accept the foreign approvals as meeting the U.S. standards.

Our navigation lights presently are certified under the NMMA Certification Procedure. The marking "A-16" on the light fixture indicates this certification.

### FUTURE (U.S.A.)

PERKO shall continue to progress in meeting the latest standards. Due to the somewhat volatile nature of the rulemaking on this subject, it is difficult to predict when, and in what exact form, new regulations will appear. Once this happens, we will have navigation lights certified to the new standard well in advance of the "effective dates" (the dates that the regulation specifies that *only* navigation lights certified to the new standard may be installed on a vessel). The U.S. Coast Guard has also indicated that a vessel under 20 meters which was fitted with navigation lights prior to an effective date, need not refit with lights certified to the new standard.

There are published rules covering the technical details of navigation lights in accordance with both the International Rules ('72 COLREGS) and the Inland Navigation Rules Act of 1980 (Public Law 96-591). These navigation rules are bound into a single volume and may be obtained from either the U.S. Coast Guard or the Superintendent of Documents by specifying "ComdtinstM16672.2."

To summarize, PERKO continues to manufacture navigation lights that meet all current and future U.S. regulations. The proper installation of a current model of PERKO navigation lights will assure the meeting of the U.S. regulation in effect at the time.

### INTERNATIONAL REGULATIONS AND APPROVALS

Certain models and configurations of PERKO navigation lights have been approved for use in over 50 countries by their respective governing authorities. Where required, appropriate approval markings are on these navigation lights. However, due to frequent changes and additions to the approval list, contact PERKO for the latest information concerning model selection for a particular purpose and/or use in a particular country.

---

**NOTE: All vertical height measurements on the following pages are from the mounting surface to the center of the bulb filament (per the chart on page 21).**

## BI-COLOR LIGHTS

FOR USE ON POWER DRIVEN VESSELS UNDER 12 METERS (39.4 ft.) IN LENGTH

**Chrome Plated Bronze or Chrome Plated Zinc Tops  
with Black Plastic Bases**  
Patent No. 3,828,714

**1 Mile Visibility  
Red and Green Lenses, Complete with 12 Volt Bulb.**



**Fig. 1310 — Chrome Plated Zinc**



**Fig. 1310**

### ORDERING INFORMATION

Dimensions Base Inches	Vertical Height Inches	Display Pkg.-5 cds. 1 Pc. per card	Std. Pkg.-5 bxs. 1 Pc. per box	OEM Pkg.	Screw Size	Weight Ounces
4 x 3 $\frac{1}{8}$	1	1310 DP CHR	1310 000 CHR	50	8	5 $\frac{1}{2}$

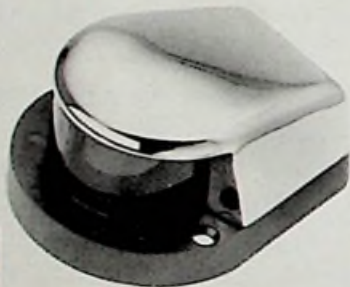

**Fig. 1161 — Chrome Plated Bronze**

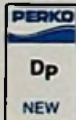

**Fig. 1161**

### ORDERING INFORMATION

Dimensions Base Inches	Vertical Height Inches	Display Pkg.-5 cds. 1 Pc. per card	Standard Pkg.-5 pcs.	OEM Pkg.	Screw Size	Weight Ounces
4 x 3 $\frac{1}{8}$	1	1161 DP CHR	1161 000 CHR	50	8	5 $\frac{1}{2}$

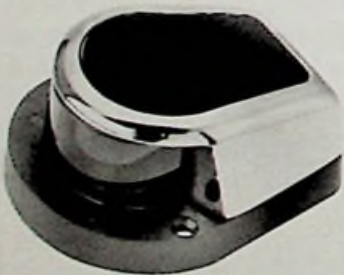

**Fig. 1410 — Chrome Plated Zinc with Black Plastic Insert**

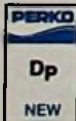

**Fig. 1410**

### ORDERING INFORMATION

Dimensions Base Inches	Vertical Height Inches	Display Pkg.-5 cds. 1 Pc. per card	Standard Pkg.-5 pcs.	OEM Pkg.	Screw Size	Weight Ounces
4 x 3 $\frac{1}{8}$	1	1410 DP CHR	1410 000 CHR	50	8	5 $\frac{1}{2}$

**NOTE: To Use The Lights on this Page in a 24 Volt System, Order Replacement Bulbs (2 per bag) Cat. No. 72 DP1 CLR.**

### SPARE PARTS ORDERING INFORMATION

Spare Bulbs, (2 per bag), Cat. No. 71 DP CLR.

Spare Lens Set (1-red & 1-green), Cat. No. 283 DPA LNS.

Spare Base with Socket Assembly, Cat. No. 136.



## BI-COLOR LIGHTS

FOR USE ON SAIL\* OR POWER DRIVEN VESSELS UNDER 12 METERS (39.4 ft.) IN LENGTH

**1 Mile Visibility  
Red and Green Lenses, Complete with 12 Volt Bulb.**

**Fig. 904 — Chrome Plated Brass Top with Black Plastic Base**

### ORDERING INFORMATION

Length Inches	Width Inches	Vertical Height Inches	Std. Pkg.-5 pcs. OEM Pkg.-10 pcs.	Screw Size	Weight Ounces
4¼	2⅞	7⁄8	904 000 CHR	4	3½



**Fig. 904**

Spare Bulbs (2 per bag), Cat. No. 71 DP CLR. Spare Lens Set (1-red & 1-green), Cat. No. 296 DP LNS.  
Spare Base with Socket Assembly, Cat. No. 107.

**Fig. 972 — Chrome Plated Brass Top with Black Plastic Base**

### ORDERING INFORMATION

O.D. Base Inches	Vertical Height Inches	Display Pkg.-5 cds. 1 Pc. per card	Std. Pkg.-5 bxs. 1 Pc. per box	OEM Pkg.	Screw Size	Weight Ounces
2⅝	7⁄8	972 DP CHR	972 000 CHR	25	4	3



**Fig. 972**

Spare Bulbs (2 per bag), Cat. No. 71 DP CLR. Spare Lens Set (1-red & 1-green), Cat. No. 296 DP LNS.  
Spare Base with Socket Assembly, Cat. No. 135.



**Fig. 120 — Chrome Plated Brass Top with Black Plastic Base**

### ORDERING INFORMATION

Height Overall Inches	Projection Overall Inches	Width Inches	Display Pkg.-5 bxs. 1 Pc. per box	Std. Pkg.-1 pc. OEM Pkg.-10 pcs.	Screw Size	Weight Ounces
3⅝	2½	4⅞	120 MB DP1	120 MB 12V	10	5



**Fig. 120 MB**

NOTE: See Page 23 For Spare Parts Ordering Information.



**Fig. 1218 — Chrome Plated Zinc with Flag Staff Socket  
\*For Use On Power Driven Vessels Only.**

### ORDERING INFORMATION

Dimensions Base Inches	Vertical Height Inches	I.D. Socket Inches	Display Pkg.-5 cds. 1 Pc. per card	Standard Pkg.-5 pcs.	Screw Size	Weight Ounces
6¼ x 3⅞	1⅝	¾	1218 DP CHR	1218 000 CHR	8	5½



**Fig. 1218**

Spare Bulbs (2 per bag), Cat. No. 71 DP CLR. Spare Lens Set (1-red & 1-green), Cat. No. 259 DPA LNS.  
Spare Socket Assembly, Cat. No. 130 DP.



NOTE: To Use The Lights on this Page (Except Fig. 120) in a 24 Volt System, Order Replacement Bulbs (2 per bag) Cat. No. 72 DP1 CLR.

## BI-COLOR LIGHTS

FOR USE ON SAIL\* OR POWER DRIVEN VESSELS UNDER 12 METERS (39.4 ft.) IN LENGTH

1 Mile Visibility

Red and Green Lenses, Complete with 12 Volt Bulb.

Fig. 120 WB

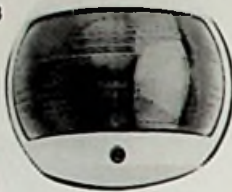

Fig. 120 BB

Fig. 120 — Black or White Plastic Tops with Black Plastic Base

### ORDERING INFORMATION

	Height Overall Inches	Projection Overall Inches	Width Inches	Display Pkg.-5 bxs. 1 Pc. per box	Std. Pkg.-1 pc. OEM Pkg.-10 pcs.	Screw Size	Weight Ounces
Color							
Black	3 $\frac{3}{8}$	2 $\frac{1}{2}$	4 $\frac{1}{8}$	120 BB DP1	120 BB 12V	10	5
White	3 $\frac{3}{8}$	2 $\frac{1}{2}$	4 $\frac{1}{8}$	120 WB DP1	120 WB 12V	10	5

NOTE: See Pages 22 or 24 For Spare Parts Ordering Information.



Fig. 1603



Fig. 1603 — Black or White Plastic

### ORDERING INFORMATION

	Vertical Height Inches	Overall Height Inches	Dimensions Base Inches	Display Pkg.-5 cds. 1 Pc. per card	Std. Pkg.-5 pcs. OEM Pkg.-50 pcs.	Screw Size	Weight Ounces
Color							
Black	1 $\frac{1}{8}$	1 $\frac{7}{8}$	1 $\frac{1}{8}$ x 3	1603 DP BLK	1603 000 BLK	8	2 $\frac{1}{4}$
White	1 $\frac{1}{8}$	1 $\frac{7}{8}$	1 $\frac{1}{8}$ x 3	1603 DP WHT	1603 000 WHT	8	2 $\frac{1}{4}$

Spare Bulbs (2 per bag), Cat. No. 71 DP CLR.

Spare Lens Set (1-red & 1-green), Cat. No. 283 DPA LNS.

Spare Base with Socket Assembly, Cat. No. 139 000 BLK or 139 000 WHT.



Fig. 1201

## TRI-COLOR FIG. 1201

\*For Use on Vessels Under Sail Alone Under 12 Meters (39.4 ft.) In Length.

Black Plastic and Chrome Plated Zinc Top with Chrome Plated Zinc Base

Red and Green Bi-Color — 1 Mile Visibility

White (Stern) — 2 Mile Visibility

### ORDERING INFORMATION

	Vertical Height Inches	Dimensions Base Inches	Display Pkg.-5 cds. 1 Pc. per card	Standard Pkg.-5 pcs. OEM Pkg.-50 pcs.	Screw Size	Weight Ounces
	3 $\frac{3}{4}$	1 x 2 $\frac{5}{8}$	1201 DP BLK	1201 000 BLK	8 R.H.	7

Spare Bulbs (2 per bag), Cat. No. 71 DP CLR.

Spare Bi-Color Lens Set (1-red & 1-green), Cat. No. 268 DP LNS.

Spare White Lenses (2 per bag), Cat. No. 278 DP WHT.

Spare Top Cap with Screw, Cat. No. 1158 DP BLK.

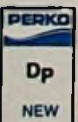

NOTE: To Use Figs. 1603 or 1201 Above in a 24 Volt System, Order Replacement Bulbs (2 per bag) Cat. No. 72 DP1 CLR.

## REMOVABLE BI-COLOR LIGHTS

FOR USE ON SAIL OR POWER DRIVEN VESSELS UNDER 12 METERS (39.4 ft.) IN LENGTH

**1 Mile Visibility — Red and Green Lenses, Complete with 12 Volt Bulb.**  
**3/4 Inch Diameter Anodized Aluminum Tube — Waterproof Cover For Bases**

**Fig. 1211 — Black Plastic and Chrome Plated Zinc Top with Utility Light  
 New Chrome Plated Brass and Black Plastic Base**

**Fig. 1212 — Black Plastic and Chrome Plated Zinc Top with Utility Light  
 Improved Chrome Plated Zinc Base**

Deck Illuminating Utility Light in the Rear Section of the Top,  
 Controlled by a Switch Located on the Top Cover.



Figs. 1211 & 1212

Vertical Height Inches	Dimensions		ORDERING INFORMATION			
	Base Inches	Display Pkg.-5 cds. 1 Pc. per card	Std. Pkg.-5 pcs. OEM Pkg.-50 pcs.	Screw Size	Weight Ounces	
10	2 1/4 O.D.	1211 DP CHR	1211 000 CHR	8	8	
10 1/4	3 3/4 x 1 3/4	1212 DP CHR	1212 000 CHR	8	8	

Spare Bulbs for Bi-Color Section (2 per bag), Cat. No. 71 DP CLR. Spare Bulb for Utility Light, Cat. No. 64 000 CLR.  
 Spare Mounting Base for Fig. No. 1211, Cat. No. 1045 300 CHR. Spare Lens Set (1-red & 1-green), Cat. No. 268 DP LNS.  
 Spare Mounting Base for Fig. No. 1212, Cat. No. 1060 3B0 CHR.



**Fig. 1296 — Black Plastic and Chrome Plated Zinc Top with Utility Light  
 and Chrome Plated Brass and Black Plastic Base**

**Water Resistant Slide Cover Base**

Deck Illuminating Utility Light in the Rear Section of the Top,  
 Controlled by a Switch Located on the Top Cover.



Fig. 1296

Vertical Height Inches	Dimensions		ORDERING INFORMATION			
	Base Inches	Display Pkg.-5 cds. 1 Pc. per card	Std. Pkg.-5 pcs. OEM Pkg.-50 pcs.	Screw Size	Weight Ounces	
10	3 1/2 x 1 1/2	1296 DP CHR	1296 000 CHR	8	8	

Spare Bulbs for Bi-Color Section (2 per bag), Cat. No. 71 DP CLR. Spare Bulb for Utility Light, Cat. No. 64 000 CLR.  
 Spare Mounting Base, Cat. No. 1047 3B0 CHR. Spare Lens Set (1-red & 1-green), Cat. No. 268 DP LNS.



**Fig. 1612 — Black Plastic Top with  
 New Chrome Plated Brass and Black Plastic Base**

Vertical Height Inches	O.D.		ORDERING INFORMATION		
	Base Inches	Std. Pkg.-1 pc. OEM Pkg.-50 pcs.	Screw Size	Weight Ounces	
9 3/4	2 1/4	1612 000 BLK	8	7	

Spare Bulbs (2 per bag), Cat. No. 71 DP CLR. Spare Lens Set (1-red & 1-green), Cat. No. 283 DP LNS.  
 Spare Mounting Base, Cat. No. 1045 P00 DP.



Fig. 1612

**Fig. 970 — Chrome Plated Brass Top with  
 New Chrome Plated Brass and Black Plastic Base**

Vertical Height Inches	O.D.		ORDERING INFORMATION		
	Base Inches	Std. Pkg.-1 pc. OEM Pkg.-50 pcs.	Screw Size	Weight Ounces	
9 3/4	2 1/4	970 000 CHR	8	8	

Spare Bulbs (2 per bag), Cat. No. 71 DP CLR. Spare Lens Set (1-red & 1-green), Cat. No. 296 DP LNS.  
 Spare Mounting Base, Cat. No. 1045 P00 DP.



Fig. 970

NOTE: To Use Figs. 970 or 1612 Above in a 24 Volt System, Order Replacement Bulbs (2 per bag) Cat. No. 72 DP1 CLR.

## SIDE LIGHTS

FOR USE ON SAIL\* OR POWER DRIVEN VESSELS UNDER 12 METERS (39.4 ft.) IN LENGTH

1 Mile Visibility — Red and Green Lenses, Complete with 12 Volt Bulbs.

**Fig. 915 — Chrome Plated Brass Tops with Black Plastic Bases  
Horizontal Surface Mount**



Fig. 915

### ORDERING INFORMATION

Length Inches	Width Inches	Vertical Height Inches	Standard Pkg.-1 pr. OEM Pkg.-10 prs.	Screw Size	Weight per Pair Ounces
4¼	2¾	7⁄8	915 000 CHR	4	7

Green Side Light Only, Cat. No. 915 G00 CHR. Spare Lens Set (1-red & 1-green), Cat. No. 281 DPA LNS.  
Red Side Light Only, Cat. No. 915 R00 CHR. Spare Base with Socket Assembly, Cat. No. 107.  
Spare Bulbs (2 per bag), Cat. No. 71 DP CLR.

**Fig. 955 — Chrome Plated Brass Tops with Black Plastic Bases  
Vertical Surface Mount**



Fig. 955

### ORDERING INFORMATION

Length Inches	Width Inches	Projection Overall Inches	Display Pkg.-5 cds. 1 Pr. per card	Standard Pkg.-5 bxs. 1 Pr. per box	OEM Pkg.	Screw Size	Weight per Pair Ounces
4¼	2¾	1¾	955 DP CHR	955 000 CHR	10 prs.	7	7

Green Side Light Only, Cat. No. 955 G00 CHR. Spare Lens Set (1-red & 1-green), Cat. No. 260 DP LNS.  
Red Side Light Only, Cat. No. 955 R00 CHR. Spare Base with Socket Assembly, Cat. No. 955 000 99A.  
Spare Bulbs (2 per bag), Cat. No. 71 DP CLR.



**Fig. 963 — Chrome Plated Brass Tops with Black Plastic Bases  
Horizontal Surface Mount**



Fig. 963

### ORDERING INFORMATION

O.D. Base Inches	Vertical Height Inches	Display Pkg.-5 cds. 1 Pr. per card	Standard Pkg.-5 bxs. 1 Pr. per box	OEM Pkg.	Screw Size	Weight per Pair Ounces
2¾	7⁄8	963 DP CHR	963 000 CHR	10 prs.	4	6

Green Side Light Only, Cat. No. 963 G00 CHR. Spare Lens Set (1-red & 1-green), Cat. No. 281 DPA LNS.  
Red Side Light Only, Cat. No. 963 R00 CHR. Spare Base with Socket Assembly, Cat. No. 135.  
Spare Bulbs (2 per bag), Cat. No. 71 DP CLR.



**Fig. 1264 — Chrome Plated Zinc with Black Vinyl Mounting Gasket  
Vertical Surface Mount**

\*For Use On Power Driven Vessels Only.

### ORDERING INFORMATION

Length Inches	Width Inches	Projection Overall Inches	Standard Pkg.-1 pr.	Screw Size	Weight per Pair Pounds
5½	3¾	1¾	1264 000 CHR	8	1¾

Green Side Light Only, Cat. No. 1264 G00 CHR. Spare Lens Set (1-red & 1-green), Cat. No. 1264 DP LNS.  
Red Side Light Only, Cat. No. 1264 R00 CHR. Spare Socket Assembly, Cat. No. 130 DP.  
Spare Bulbs (2 per bag), Cat. No. 71 DP CLR.

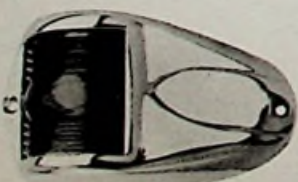

Fig. 1264



NOTE: To Use The Lights on this Page in a 24 Volt System, Order Replacement Bulbs (2 per bag), Cat. No. 72 DP CLR.

## SIDE LIGHTS

FOR USE ON SAIL OR POWER DRIVEN VESSELS UNDER 12 METERS (39.4 ft.) IN LENGTH

1 Mile Visibility — Red and Green Lenses, Complete with 12 Volt Bulbs.

**Fig. 120 — Chrome Plated Brass Top with Black Plastic Base**

Description	Height Overall Inches	Projection Overall Inches	Width Inches	ORDERING INFORMATION			Screw Size	Weight Ounces
				Display Pkg.-5 bxs. 1 Pc. per box	Std. Pkg.-1 pc. OEM Pkg.-10 pcs.			
Red Side Light	3 <sup>5</sup> / <sub>8</sub>	2 <sup>1</sup> / <sub>2</sub>	4 <sup>1</sup> / <sub>8</sub>	120 MP DP1	120 MP 12V	10	5	
Green Side Light	3 <sup>5</sup> / <sub>8</sub>	2 <sup>1</sup> / <sub>2</sub>	4 <sup>1</sup> / <sub>8</sub>	120 MSD DP1	120 MSD 12V	10	5	



Fig. 120 MSD



NOTE: See Page 23 For Spare Parts Ordering Information.

**Fig. 120 — Black or White Plastic Tops with Black Plastic Base**

Description	Height Overall Inches	Projection Overall Inches	Width Inches	ORDERING INFORMATION			Screw Size	Weight Ounces
				Display Pkg.-5 bxs. 1 Pc. per box	Std. Pkg.-1 pc. OEM Pkg.-10 pcs.			
<b>Black Plastic</b>								
Red Side Light	3 <sup>5</sup> / <sub>8</sub>	2 <sup>1</sup> / <sub>2</sub>	4 <sup>1</sup> / <sub>8</sub>	120 BP DP1	120 BP 12V	10	5	
Green Side Light	3 <sup>5</sup> / <sub>8</sub>	2 <sup>1</sup> / <sub>2</sub>	4 <sup>1</sup> / <sub>8</sub>	120 BSD DP1	120 BSD 12V	10	5	
<b>White Plastic</b>								
Red Side Light	3 <sup>5</sup> / <sub>8</sub>	2 <sup>1</sup> / <sub>2</sub>	4 <sup>1</sup> / <sub>8</sub>	120 WP DP1	120 WP 12V	10	5	
Green Side Light	3 <sup>5</sup> / <sub>8</sub>	2 <sup>1</sup> / <sub>2</sub>	4 <sup>1</sup> / <sub>8</sub>	120 WSD DP1	120 WSD 12V	10	5	



Fig. 120 BSD



Fig. 120 WSD



NOTE: See Page 22 or 24 For Spare Parts Ordering Information.

**Fig. 1601 — Black or White Plastic**

**Normal "Base-Down" Mount**

**ORDERING INFORMATION**

Color	Vertical Height Inches	Height Overall Inches	Dimensions Base Inches	ORDERING INFORMATION		
				Std. Pkg.-5 prs. OEM Pkg.-50 prs.	Screw Size	Weight Ounces
Black	1 <sup>1</sup> / <sub>8</sub>	1 <sup>7</sup> / <sub>8</sub>	1 <sup>1</sup> / <sub>8</sub> x 3	1601 000 BLK	8	2 <sup>1</sup> / <sub>4</sub>
White	1 <sup>1</sup> / <sub>8</sub>	1 <sup>7</sup> / <sub>8</sub>	1 <sup>1</sup> / <sub>8</sub> x 3	1601 000 WHT	8	2 <sup>1</sup> / <sub>4</sub>



Fig. 1601



Spare Bulbs (2 per bag), Cat. No. 71 DP CLR. Spare Lens Set (1-red & 1-green), Cat. No. 283 DPA LNS.  
Spare Base with Socket Assembly, Cat. No. 139 000 BLK or 139 000 WHT.

**Fig. 1602 — Black or White Plastic**

**Inverted "Base-Up" Mount**

**ORDERING INFORMATION**

Color	Vertical Height Inches	Height Overall Inches	Dimensions Base Inches	ORDERING INFORMATION		
				Std. Pkg.-5 prs. OEM Pkg.-50 prs.	Screw Size	Weight Ounces
Black	1 <sup>1</sup> / <sub>8</sub>	1 <sup>7</sup> / <sub>8</sub>	1 <sup>1</sup> / <sub>8</sub> x 3	1602 000 BLK	8	2 <sup>1</sup> / <sub>4</sub>
White	1 <sup>1</sup> / <sub>8</sub>	1 <sup>7</sup> / <sub>8</sub>	1 <sup>1</sup> / <sub>8</sub> x 3	1602 000 WHT	8	2 <sup>1</sup> / <sub>4</sub>



Fig. 1602



Spare Bulbs (2 per bag), Cat. No. 71 DP CLR. Spare Lens Set (1-red & 1-green), Cat. No. 283 DPA LNS.  
Spare Base with Socket Assembly, Cat. No. 139 000 BLK or 139 000 WHT.

NOTE: To Use Figs. 1601 or 1602 Above in a 24 Volt System, Order Replacement Bulbs (2 per bag), Cat. No. 72 DP CLR.

## STERN LIGHTS

FOR USE ON SAIL OR POWER DRIVEN VESSELS UNDER 20 METERS (65.6 ft.) IN LENGTH

2 Mile Visibility — Clear Lens, Complete with 12 Volt Bulb.



Fig. 965



Fig. 945

Fig. 945 — Chrome Plated Brass Top with Black Plastic Base  
Vertical Surface Mount

Fig. 965 — Chrome Plated Brass Top with Black Plastic Base  
Horizontal Surface Mount

### ORDERING INFORMATION

O.D. Base Inches	Projection/Height Overall Inches	Display Pkg.-5 cds. 1 Pc. per card	Std. Pkg.-5 bxs. 1 Pc. per box	OEM Pkg.	Screw Size	Weight Ounces
2 $\frac{3}{8}$	1 $\frac{5}{8}$	945 DP CHR	945 000 CHR	25	4	3
2 $\frac{3}{8}$	1 $\frac{5}{8}$	965 DP CHR	965 000 CHR	25	4	3

Spare Bulb For Both (2 per bag), Cat. No. 71 DP CLR.

Spare Base and Socket Assembly For Fig. No. 965, Cat. No. 135.

Spare Base and Socket Assembly For Fig. No. 945, Cat. No. 945 DP 99A.

Spare Lens For Fig. No. 945, Cat. No. 74 DP WHT.

Spare Lens For Fig. No. 965, Cat. No. 281 DPA WHT.



Fig. 940

Fig. 940 — Chrome Plated Brass Top with Chrome Plated Brass and Black Plastic Base  
Horizontal Surface Mount

### ORDERING INFORMATION

Height Overall Inches	O.D. Base Inches	Std. Pkg.-1 pc. OEM Pkg.-50 pcs.	Screw Size	Weight Ounces
16	2 $\frac{1}{4}$	940 000 CHR	8	8

Spare Bulbs (2 per bag), Cat. No. 71 DP CLR.

Spare Base, Cat. No. 1045 P00 DP.

Spare Lens, Cat. No. 281 DPA WHT.

NOTE: To Use The Above Lights in a 24 Volt System, Order Replacement Bulbs (2 per bag), Cat. No. 72 DP1 CLR.

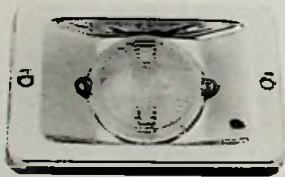

Fig. 939

Fig. 939 — Chrome Plated Brass Top with Black Plastic Base  
Vertical Flush Mount

### ORDERING INFORMATION

Dimensions Inches	Depth Inches	Display Pkg.-5 cds. 1 Pc. per card	Std. Pkg.-5 bxs. 1 Pc. per box	OEM Pkg.	Screw Size	Weight Ounces
5 $\frac{3}{16}$ x 3 $\frac{3}{8}$	1 $\frac{1}{2}$	939 DP1 12V	939 001 12V	20	8	4
5 $\frac{3}{16}$ x 3 $\frac{3}{8}$	1 $\frac{1}{2}$	-----	939 003 32V	---	8	4

Spare 12 Volt Bulbs (2 per bag), Cat. No. 70 DP0 CLR.

Spare 32 Volt Bulbs (2 per bag), Cat. No. 70 DP2 CLR.

Spare Lens with Gasket, Cat. No. 284 DP CLR.

Spare 12 Volt Socket Assembly, Cat. No. 939 DP1 99A.

Spare 32 Volt Socket Assembly, Cat. No. 939 003 99A.

Spare Mounting Flange, Cat. No. 939 000 99C.

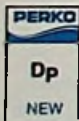

Fig. 946

Fig. 946 — Chrome Plated Brass with Black Plastic Base  
Vertical Flush Mount

### ORDERING INFORMATION

O.D. Inches	Depth Inches	Display Pkg.-5 cds. 1 Pc. per card	Std. Pkg.-5 bxs. 1 Pc. per box	OEM Pkg.	Screw Size	Weight Ounces
3	1 $\frac{3}{4}$	946 DP1 12V	946 001 12V	25	8	4
3	1 $\frac{3}{4}$	-----	946 003 32V	---	8	4

Spare 12 Volt Bulbs (2 per bag), Cat. No. 70 DP0 CLR.

Spare 32 Volt Bulbs (2 per bag), Cat. No. 70 DP2 CLR.

Spare Lens with Gasket, Cat. No. 946 DP 99A.

Spare 12 Volt Socket Assembly, Cat. No. 946 DP1 99B.

Spare 32 Volt Socket Assembly, Cat. No. 946 003 99B.

Spare Mounting Flange, Cat. No. 946 000 99C.



## STERN LIGHTS

FOR USE ON SAIL OR POWER DRIVEN VESSELS UNDER 20 METERS (65.6 ft.) IN LENGTH.

2 Mile Visibility  
Clear Lens, Complete with 12 Volt Bulb.

**Fig. 120 — Chrome Plated Brass Top with Black Plastic Base**

**Vertical Surface Mount**



**Fig. 120 MSN**

ORDERING INFORMATION						
Height Overall Inches	Projection Overall Inches	Width Inches	Display Pkg.-5 bxs. 1 Pc. per box	Std. Pkg.-1 pc. OEM Pkg.-10 pcs.	Screw Size	Weight Ounces
3 <sup>5</sup> / <sub>8</sub>	2 <sup>1</sup> / <sub>2</sub>	4 <sup>1</sup> / <sub>8</sub>	120 MSN DP1	120 MSN 12V	10	5

NOTE: See Page 23 For Spare Parts Ordering Information.



**Fig. 120 BSN**



**Fig. 120 WSN**

**Fig. 120 — Black or White Plastic Tops with Black Plastic Bases**

**Vertical Surface Mount**

ORDERING INFORMATION							
Color	Height Overall Inches	Projection Overall Inches	Width Inches	Display Pkg.-5 bxs. 1 Pc. per box	Std. Pkg.-1 pc. OEM Pkg.-10 pcs.	Screw Size	Weight Ounces
Black	3 <sup>5</sup> / <sub>8</sub>	2 <sup>1</sup> / <sub>2</sub>	4 <sup>1</sup> / <sub>8</sub>	120 BSN DP1	120 BSN 12V	10	5
White	3 <sup>5</sup> / <sub>8</sub>	2 <sup>1</sup> / <sub>2</sub>	4 <sup>1</sup> / <sub>8</sub>	120 WSN 12V	120 WSN 12V	10	5

NOTE: See Page 22 or 24 For Spare Parts Ordering Information.



**Fig. 1332 — Chrome Plated Zinc with Black Plastic Base**

**Vertical Surface Mount**



**Fig. 1332**

ORDERING INFORMATION				
Length Inches	Width Inches	Std. Pkg.-5 pcs. OEM Pkg.-50 pcs.	Screw Size	Weight Ounces
3 <sup>3</sup> / <sub>4</sub>	1 <sup>1</sup> / <sub>2</sub>	1332 000 CHR	5	4

Spare Bulbs (2 per bag), Cat. No. 71 DP CLR. Spare Lenses (2 per bag), Cat. No. 278 DP WHT.

NOTE: To Use This Light in a 24 Volt System, Order Replacement Bulbs (2 per bag), Cat. No. 72 DP1 CLR.

## MASTHEAD LIGHTS

FOR USE ON SAIL OR POWER DRIVEN VESSELS UNDER 12 METERS (39.4 ft.) IN LENGTH.

**2 Mile Visibility  
Clear Lens, Complete with 12 Volt Bulb.**



Fig. 120 MM

Fig. 120 — Chrome Plated Brass Top with Black Plastic Base

**Vertical Mount**

### ORDERING INFORMATION

Height Overall Inches	Projection Overall Inches	Width Inches	Display Pkg.-5 bxs. 1 Pc. per box	Std. Pkg.-1 pc. OEM Pkg.-10 pcs.	Screw Size	Weight Ounces
3 $\frac{5}{8}$	2 $\frac{1}{2}$	4 $\frac{1}{8}$	120 MM DP1	120 MM 12V	10	5

NOTE: See Page 23 For Spare Parts Ordering Information.



Fig. 120 BM

Fig. 120 — Black or White Plastic Tops with Black Plastic Base

**Vertical Mount**

### ORDERING INFORMATION

Color	Height Overall Inches	Projection Overall Inches	Width Inches	Display Pkg.-5 bxs. 1 Pc. per box	Std. Pkg.-1 pc. OEM Pkg.-10 pcs.	Screw Size	Weight Ounces
Black	3 $\frac{5}{8}$	2 $\frac{1}{2}$	4 $\frac{1}{8}$	120 BM DP1	120 BM 12V	10	5
White	3 $\frac{5}{8}$	2 $\frac{1}{2}$	4 $\frac{1}{8}$	120 WM 12V	120 WM 12V	10	5

NOTE: See Page 22 or 24 For Spare Parts Ordering Information.

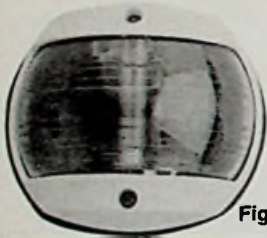

Fig. 120 WM



Fig. 120 BMD

Fig. 120 — Combination Masthead and Deck Spreader Light

**Black Plastic  
Vertical Mount**

### ORDERING INFORMATION

Height Overall Inches	Projection Overall Inches	Width Inches	Display Pkg.-5 bxs. 1 Pc. per box	Std. Pkg.-1 pc. OEM Pkg.-10 pcs.	Screw Size	Weight Ounces
7	4 $\frac{3}{4}$	4 $\frac{1}{8}$	120 BMD DP1	120 BMD 12V	10	18 $\frac{1}{2}$

NOTE: See Page 22 For Spare Parts Ordering Information.





## MASTHEAD LIGHTS

FOR USE ON SAIL OR POWER DRIVEN VESSELS AS SPECIFIED BELOW.

**Clear Lens, Complete with 12 Volt Bulb.**

**Fig. 964 — Chrome Plated Brass Top with Black Plastic Base  
For Use On Vessels Under 12 Meters (39.4 ft.) In Length.**

**Horizontal Surface Mount  
2 Mile Visibility**



Fig. 964

### ORDERING INFORMATION

O.D. Base Inches	Vertical Height Inches	Display Pkg.-5 cds. 1 Pc. per card	Std. Pkg.-5 bxs. 1 Pc. per box	OEM Pkg.	Screw Size	Weight Ounces
2 3/8	7/8	964 DP CHR	964 000 CHR	25	4	3

Spare Bulbs (2 per bag), Cat. No. 71 DP CLR.  
Spare Lens, Cat. No. 281 DPA WHT.

Spare Base with Socket Assembly, Cat. No. 135.



**Fig. 1331 — Chrome Plated Zinc with Black Plastic Base  
For Use On Vessels Under 20 Meters (65.6 ft.) In Length.**

**Vertical Surface Mount  
3 Mile Visibility**



Fig. 1331

### ORDERING INFORMATION

Length Inches	Width Inches	Std. Pkg.-5 pcs. OEM Pkg.-50 pcs.	Screw Size	Weight Ounces
3 3/4	1 1/2	1331 000 CHR	5	4

Spare Bulbs (2 per bag), Cat. No. 71 DP CLR.

Spare Lenses (2 per bag), Cat. No. 278 DP WHT.

**Fig. 1178 — Black Plastic and Chrome Plated Zinc Top  
with Chrome Plated Zinc Base  
For Use On Vessels Under 20 Meters (65.6 ft.) In Length.**

**Horizontal Surface Mount  
3 Mile Visibility**



Fig. 1178

### ORDERING INFORMATION

Vertical Height Inches	Dimensions Base Inches	Display Pkg.-5 cds. 1 Pc. per card	Std. Pkg.-5 bxs. 1 Pc. per box	OEM Pkg.	Screw Size	Weight Ounces
3 1/4	1 x 2 5/8	1178 DP CHR	1178 000 CHR	50	8 R.H.	7

Spare Bulbs (2 per bag), Cat. No. 71 DP CLR.

Spare Lenses (2 per bag), Cat. No. 278 DP WHT.

Spare Top Cap and Screw, Cat. No. 1158 DP BLK.



NOTE: To Use The Lights on this Page in a 24 Volt System, Order Replacement Bulbs (2 per bag) Cat. No. 72 DP1 CLR.

## COMBINATION MASTHEAD AND WHITE ALL-ROUND LIGHTS FOR USE ON SAIL OR POWER DRIVEN VESSELS UNDER 20 METERS (65.6 ft.) IN LENGTH

**3 Mile Visibility**  
**Clear Lenses, Complete with Two 12 Volt Bulbs.**  
**Black Plastic and Chrome Plated Zinc Tops with Chrome Plated Zinc Bases.**  
**3/4 Inch Diameter Anodized Aluminum Tubes**



Fig. 1181



Fig. 1181 — Fold-Down, Adjustable Angle, Horizontal Mount  
Plastic Adapters for Flat or "V" Type Mount

### Improved Mounting Bracket

Vertical Height Inches	Dimensions Bracket Inches	ORDERING INFORMATION			Weight Pounds
		Display Pkg.-5 cds. 1 Pc. per card	Std. Pkg.-5 bxs. 1 Pc. per box		
12 $\frac{5}{8}$	2 x 1 $\frac{1}{2}$	1181 DP CHR	1181 000 CHR		3/4
	OEM Pkg.-50 Pcs.		Screw Size #8		

Spare Bracket with Knob and End Plug, Cat. No. 1052 DP CHR.  
 Spare Knob, Cat. No. 1144 A00 BLK.

Fig. 1184 — Fold-Down, Adjustable Angle, Vertical Mount  
Plastic Adapters for Flat or "V" Type Mount

### Improved Mounting Bracket

Vertical Height Inches	Dimensions Bracket Inches	ORDERING INFORMATION			Weight Pounds
		Display Pkg.-5 cds. 1 Pc. per card	Std. Pkg.-5 bxs. 1 Pc. per box		
12 $\frac{5}{8}$	2 $\frac{1}{4}$ x 5 $\frac{5}{8}$	1184 DP CHR	1184 000 CHR		3/4
	OEM Pkg.-50 Pcs.		Screw Size #8		

Spare Bracket with Knob and End Plug, Cat. No. 1054 DP CHR.  
 Spare Knob, Cat. No. 1144 A00 BLK.

Figs. 1183 and 1196 — Fixed Mount



Fig. 1196



Fig. 1183

Vertical Height Inches	Dimensions Base Inches	ORDERING INFORMATION			Weight Ounces
		Display Pkg.-5 cds. 1 Pc. per card	Std. Pkg.-5 bxs. 1 Pc. per box		
3 $\frac{3}{4}$	1 x 2 $\frac{5}{8}$	1183 DP CHR	1183 000 CHR		7
5 $\frac{1}{4}$	1 x 2 $\frac{5}{8}$	1196 DP1 CHR	1196 001 CHR		8
11 $\frac{1}{4}$	1 x 2 $\frac{5}{8}$	1196 DP2 CHR	1196 002 CHR		8
	OEM Pkg.-50 Pcs.		Screw Size #8 R.H.		

Fig. 1197 — Fixed Mount

### ORDERING INFORMATION

Vertical Height Inches	Length Tubing Inches	Standard Pkg.-5 pcs. OEM Pkg.-50 pcs.	Weight Ounces
4	1	1197 000 CHR	7

NOTE: To Use The Lights on this Page in a 24 Volt System, Order Replacement Bulbs (2 per bag) Cat. No. 72 DP1 CLR.

### SPARE PARTS ORDERING INFORMATION

Spare Bulbs (2 per bag), Cat. No. 71 DP CLR.  
 Spare Top Cap with Screw, Cat. No. 1158 DP BLK.

Spare Lenses (2 per bag), Cat. No. 278 DP WHT.

## COMBINATION MASTHEAD AND WHITE ALL-ROUND LIGHTS FOR USE ON SAIL OR POWER DRIVEN VESSELS UNDER 20 METERS (65.6 ft.) IN LENGTH

### Stow-A-Way Plug-In Type

**3 Mile Visibility**  
**Clear Lenses, Complete with Two 12 Volt Bulbs.**  
**Black Plastic and Chrome Plated Zinc Top, 3/4 Inch Diameter Anodized Aluminum Tubes, Waterproof Cover For Bases**

**Fig. 1123 — Horizontal Mount**

**Chrome Plated Zinc Mounting Bracket**  
**Plastic Adapters for Flat or "V" Type 45 Degree Windshields.**

Vertical Height Inches	ORDERING INFORMATION		
	Standard Pkg.-1 pc. OEM Pkg.-50 pcs.	Screw Size	Weight Pounds
11½	1123 001 CHR	8	1
20¾	1123 002 CHR	8	1½

Spare Bulbs (2 per bag), Cat. No. 71 DP CLR.      Spare Cap for Base, Cat. No. 125 DP BLK.  
Spare Lenses (2 per bag), Cat. No. 278 DP WHT.      Spare Base with Socket Assembly, Cat. No. 1123 000 99A.  
Spare Top Cap with Screw, Cat. No. 1158 DP BLK.

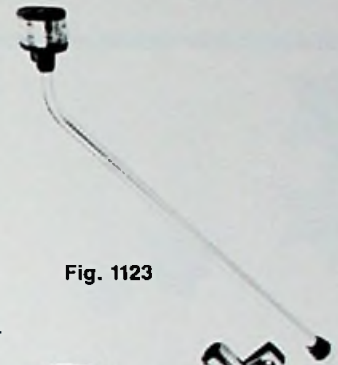

**Fig. 1123**

**Fig. 1124 — Vertical Mount**

**Chrome Plated Zinc Mounting Bracket**  
**Plastic Adapters for Flat or "V" Type 45 Degree Windshields.**

Vertical Height Inches	ORDERING INFORMATION		
	Standard Pkg.-1 pc. OEM Pkg.-50 pcs.	Screw Size	Weight Pounds
11½	1124 001 CHR	8	1
20¾	1124 002 CHR	8	1½

Spare Bulbs (2 per bag), Cat. No. 71 DP CLR.      Spare Cap for Base, Cat. No. 125 DP BLK.  
Spare Lenses (2 per bag), Cat. No. 278 DP WHT.      Spare Base with Socket Assembly, Cat. No. 1124 000 99A.  
Spare Top Cap with Screw, Cat. No. 1158 DP BLK.

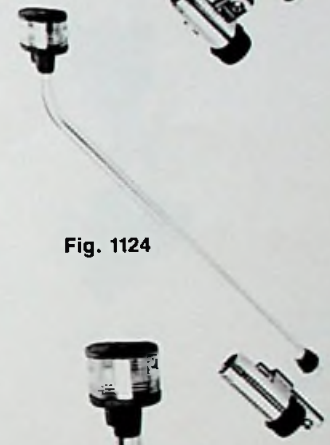

**Fig. 1124**

**Fig. 1125 — Deck Mount**

**Chrome Plated Brass Base**

Vertical Height Inches	Dimensions Base Inches	ORDERING INFORMATION		
		Standard Pkg.-1 pc. OEM Pkg.-50 pcs.	Screw Size	Weight Pounds
33⅝	3¾ x 2¼	1125 004 CHR	8	1½

Spare Bulbs (2 per bag), Cat. No. 71 DP CLR.      Spare Cap for Base, Cat. No. 125 DP BLK.  
Spare Lenses (2 per bag), Cat. No. 278 DP WHT.      Spare Base with Socket Assembly, Cat. No. 1125 000 99A.  
Spare Top Cap with Screw, Cat. No. 1158 DP BLK.



**Fig. 1125**

**NOTE: To Use The Lights Above in a 24 Volt System, Order Replacement Bulbs (2 per bag) Cat. No. 72 DP1 CLR.**

## GLARE SHIELD      FIG. 1192

**Black Plastic**

For 3/4 Inch O.D. Tubing, Can Be Installed Without Removing Light.  
Complete With Mounting Screws.

Dimensions Inches	ORDERING INFORMATION		Weight Ounces
	Display Pkg.-5 bags 1 Pc. per bag	OEM Pkg.-25 pcs.	
6 x 4⅝	1192 DP BLK	1192 000 BLK	3

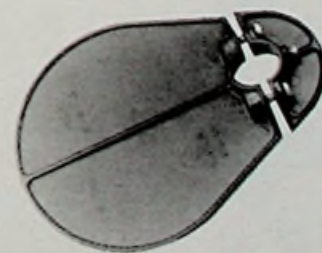

**Fig. 1192**



## WHITE ALL-ROUND LIGHTS

FOR USE ON SAIL OR POWER DRIVEN VESSELS UNDER 20 METERS (65.6 ft.) IN LENGTH.

### Stow-A-Way Plug-In Type

**2 Mile Visibility**  
**Complete with 12 Volt Bulb**  
**3/4 Inch Diameter Anodized Aluminum Tubes,**  
**Water Resistant Slide Cover For Bases**



**Fig. 1640 — White Translucent Globe, Black Plastic Top, with Black Plastic and Chrome Plated Brass Base**

Vertical Height Inches	ORDERING INFORMATION		Weight Pounds
	Display Pkg.-5 bags 1 Pc. per bag	Standard Pkg.-5 pcs. OEM Pkg.-50 pcs.	
20 <sup>5</sup> / <sub>8</sub>	1640 DP2 CHR	1640 002 CHR	1
27 <sup>1</sup> / <sub>8</sub>	1640 DP3 CHR	1640 003 CHR	1 <sup>1</sup> / <sub>8</sub>
33 <sup>3</sup> / <sub>4</sub>	1640 DP4 CHR	1640 004 CHR	1 <sup>1</sup> / <sub>4</sub>
40 <sup>1</sup> / <sub>2</sub>	1640 DP5 CHR	1640 005 CHR	1 <sup>3</sup> / <sub>8</sub>
46 <sup>1</sup> / <sub>2</sub>	1640 DP6 CHR	1640 006 CHR	1 <sup>1</sup> / <sub>2</sub>
51 <sup>1</sup> / <sub>2</sub>	1640 DP7 CHR	1640 007 CHR	1 <sup>5</sup> / <sub>8</sub>

Base Length 3<sup>1</sup>/<sub>2</sub>", Width 1<sup>1</sup>/<sub>2</sub>", Screw Size, #8.

Spare Bulbs (2 per bag), Cat. No. 337 012 DP. Spare Globe, Cat. No. 201 DP WHT.  
 Spare Base with Socket Assembly, Cat. No. 1046 P00 CHR.



**Fig. 1640**



**Fig. 1660 — White Translucent Globe, Black Plastic Top, with Black Plastic and Chrome Plated Brass Base**

Vertical Height Inches	ORDERING INFORMATION		Weight Pounds
	Display Pkg.-5 bags 1 Pc. per bag	Standard Pkg.-5 pcs. OEM Pkg.-50 pcs.	
40 <sup>5</sup> / <sub>8</sub>	1660 DP5 CHR	1660 005 CHR	1 <sup>3</sup> / <sub>8</sub>
46 <sup>5</sup> / <sub>8</sub>	1660 DP6 CHR	1660 006 CHR	1 <sup>1</sup> / <sub>2</sub>
51 <sup>5</sup> / <sub>8</sub>	1660 DP7 CHR	1660 007 CHR	1 <sup>5</sup> / <sub>8</sub>

Base Length 3<sup>1</sup>/<sub>2</sub>", Width 1<sup>1</sup>/<sub>2</sub>", Screw Size, #8.

Spare Bulbs (2 per bag), Cat. No. 337 012 DP. Spare Globe, Cat. No. 201 DP WHT.  
 Spare Base with Socket Assembly, Cat. No. 1047 P00 CHR.



**Fig. 1660**

## WHITE ALL-ROUND LIGHTS

FOR USE ON SAIL OR POWER DRIVEN VESSELS UNDER 20 METERS (65.6 ft.) IN LENGTH.

### Stow-A-Way Plug-In Type

**2 Mile Visibility**  
**Complete with 12 Volt Bulb**  
**¾ Inch Diameter Anodized Aluminum Tubes,**  
**Waterproof Cover For Bases**

**Fig. 1430 — White Translucent Globe, Black Plastic Top, Chrome Plated Zinc Base with Black Plastic Insert**

#### Improved Locking Collar

Vertical Height Inches	ORDERING INFORMATION		
	Display Pkg.-5 bags 1 Pc. per bag	Standard Pkg.-5 pcs. OEM Pkg.-50 pcs.	Weight Pounds
21	1430 DP2 CHR	1430 002 CHR	1
27¼	1430 DP3 CHR	1430 003 CHR	1⅛
33½	1430 DP4 CHR	1430 004 CHR	1¼
40¾	1430 DP5 CHR	1430 005 CHR	1⅜
46¾	1430 DP6 CHR	1430 006 CHR	1½
51¾	1430 DP7 CHR	1430 007 CHR	1⅝

Base Length 3¾", Width 1¼", Screw Size, #8.

Spare Bulbs (2 per bag), Cat. No. 337 012 DP. Spare Globe, Cat. No. 201 DP WHT.  
 Spare Base with Socket Assembly, Cat. No. 1060 P80 DP.



Fig. 1430



**Fig. 1631 — White Translucent Globe, Black Plastic Top, Chrome Plated Brass and Black Plastic Base**

#### Improved Locking Collar

Vertical Height Inches	ORDERING INFORMATION		
	Display Pkg.-5 bags 1 Pc. per bag	Standard Pkg.-5 pcs. OEM Pkg.-50 pcs.	Weight Pounds
40¼	1631 DP5 CHR	1631 005 CHR	1⅜
46¾	1631 DP6 CHR	1631 006 CHR	1½

O.D. Base 2¼", Screw Size, #8.

Spare Bulbs (2 per bag), Cat. No. 337 012 DP. Spare Globe, Cat. No. 201 DP WHT.  
 Spare Base with Socket Assembly, Cat. No. 1045 P00 DP.



Fig. 1631



## WHITE ALL-ROUND LIGHTS

FOR USE ON POWER\* DRIVEN VESSELS UNDER 20 METERS (65.6 ft.) IN LENGTH.

### Stow-A-Way Plug-In Type

2 Mile Visibility

Complete with 12 Volt Bulb

3/4 Inch Diameter Anodized Aluminum Tubes,  
Waterproof Cover For Bases

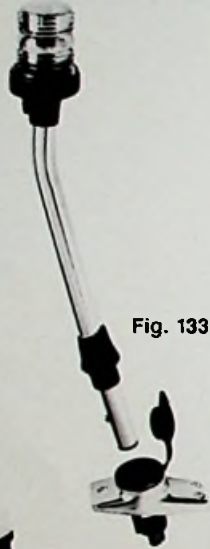

Fig. 1330



Fig. 1630

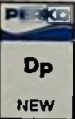

Fig. 1209

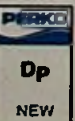

Fig. 1330 — Clear Fresnel Globe,  
Black Plastic Top, Chrome Plated Zinc Base

### Improved Locking Collar

#### ORDERING INFORMATION

Vertical Height Inches	Display Pkg.-5 bags 1 Pc. per bag	Standard Pkg.-5 pcs. OEM Pkg.-50 pcs.	Weight Pounds
20½	1330 DP2 CHR	1330 002 CHR	1
26⅝	1330 DP3 CHR	1330 003 CHR	1⅛
32½	1330 DP4 CHR	1330 004 CHR	1¼

Base Length 3¾", Width 1⅝", Screw Size, #8.

Spare Bulbs (2 per bag), Cat. No. 337 011 DP. Spare Globe, Cat. No. 248 DP CLR.  
Spare Base with Socket Assembly, Cat. No. 1059 P00 DP.

Fig. 1630 — White Translucent Globe, Black Plastic Top,  
Chrome Plated Zinc Base

\*For Use On Sail or Power Driven Vessels

### Improved Locking Collar

#### ORDERING INFORMATION

Vertical Height Inches	Display Pkg.-5 bags 1 Pc. per bag	Standard Pkg.-5 pcs. OEM Pkg.-50 pcs.	Weight Pounds
20¾	1630 DP2 CHR	1630 002 CHR	1
26⅝	1630 DP3 CHR	1630 003 CHR	1⅛
32¾	1630 DP4 CHR	1630 004 CHR	1¼
40	1630 DP5 CHR	1630 005 CHR	1⅜
45½	1630 DP6 CHR	1630 006 CHR	1½
50½	1630 DP7 CHR	1630 007 CHR	1⅝

Base Length 3¾", Width 1⅝", Screw Size, #8.

Spare Bulbs (2 per bag), Cat. No. 337 012 DP. Spare Globe, Cat. No. 201 DP WHT.  
Spare Base with Socket Assembly, Cat. No. 1059 P00 DP.

Fig. 1209 — Clear Fresnel Globe,  
Chrome Plated Brass Top and Base

#### ORDERING INFORMATION

Vertical Height Inches	Display Pkg.-5 bags 1 Pc. per bag	Standard Pkg.-5 pcs. OEM Pkg.-50 pcs.	Weight Pounds
21⅜	1209 DP2 CHR	1209 002 CHR	1
28⅜	1209 DP3 CHR	1209 003 CHR	1¼
34	1209 DP4 CHR	1209 004 CHR	1½

Base Length 3⅝", Width 2¼", Screw Size, #8.

Spare Bulbs (2 per bag), Cat. No. 337 011 DP. Spare Bulb Socket, Cat. No. 24 DP2.  
Spare Globe, Cat. No. 248 DP CLR. Spare Cap for Base, Cat. No. 125 DP BLK.  
Spare Base with Socket Assembly, Cat. No. 1209 DP 99A.

## WHITE ALL-ROUND LIGHTS

FOR USE ON SAIL\* OR POWER DRIVEN VESSELS UNDER 20 METERS (65.6 ft.) IN LENGTH.

Telescoping Type

2 Mile Visibility  
Complete with 12 Volt Bulb  
3/4 Inch Diameter Anodized Aluminum Tubes

**Fig. 1311 — Clear Fresnel Globe,  
Black Plastic Top, Chrome Plated Zinc Base**

\*For Use on Power Driven Vessels Only.

### Improved Locking Collar

Vertical Height Inches	ORDERING INFORMATION		
	Display Pkg.-5 bags 1 Pc. per bag	Standard Pkg.-5 pcs. OEM Pkg.-50 pcs.	Weight Pounds
20½	1311 DP2 CHR	1311 002 CHR	7/8
26⅝	1311 DP3 CHR	1311 003 CHR	1
32½	1311 DP4 CHR	1311 004 CHR	1½

Base Length 3¾", Width 1⅝", Screw Size, #8.

Spare Bulbs (2 per bag), Cat. No. 337 011 DP. Spare Base, Cat. No. 1059 T00 DP.  
Spare Globe, Cat. No. 248 DP CLR.



Fig. 1311



**Fig. 1611 — White Translucent Globe, Black Plastic Top,  
Chrome Plated Zinc Base**

### Improved Locking Collar

Vertical Height Inches	ORDERING INFORMATION		
	Display Pkg.-5 bags 1 Pc. per bag	Standard Pkg.-5 pcs. OEM Pkg.-50 pcs.	Weight Pounds
20¾	1611 DP2 CHR	1611 002 CHR	7/8
26⅝	1611 DP3 CHR	1611 003 CHR	1
32¾	1611 DP4 CHR	1611 004 CHR	1½

Base Length 3¾", Width 1⅝", Screw Size, #8.

Spare Bulbs (2 per bag), Cat. No. 337 012 DP. Spare Base, Cat. No. 1059 T00 DP.  
Spare Globe, Cat. No. 201 DP WHT.



Fig. 1611

**Fig. 1411 — White Translucent Globe, Black Plastic Top,  
Chrome Plated Zinc Base with Black Plastic Insert**

### Improved Locking Collar

Vertical Height Inches	ORDERING INFORMATION		
	Display Pkg.-5 bags 1 Pc. per bag	Standard Pkg.-5 pcs. OEM Pkg.-50 pcs.	Weight Pounds
21	1411 DP2 CHR	1411 002 CHR	7/8
27¼	1411 DP3 CHR	1411 003 CHR	1
33½	1411 DP4 CHR	1411 004 CHR	1½

Base Length 3¾", Width 1¾", Screw Size, #8.

Spare Bulb (2 per bag), Cat. No. 337 012 DP. Spare Base, Cat. No. 1060 T80 DP.  
Spare Globe, Cat. No. 201 DP WHT.



Fig. 1411

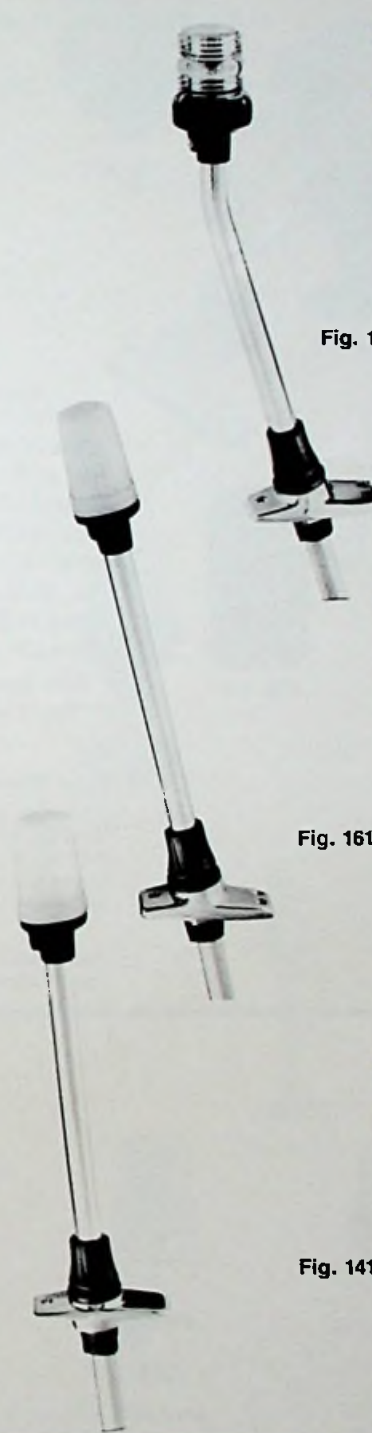

## ALL-ROUND LIGHTS

FOR USE ON SAIL† OR POWER DRIVEN VESSELS UNDER 20 METERS (65.6 ft.) IN LENGTH.

2 Mile Visibility



Fig. 112



Fig. 309



Fig. 108

Fig. 108 — Cast Zinc, Black PERKO-KOTE Finish Festoon Type Electrical Socket

†For Power Driven Vessels Only.

Figs. 112 & 309 — Cast Bronze, Plain or Chrome Plated Medium Screw Base Type Electrical Socket

For 12 or 32 Volts. Bulb Not Included.

Fig.	Height Overall Inches	O.D. Base Inches	Tapped Pipe Size Inches	Screw Size	Weight Pounds
108	6	3 1/4	1/2 *	10	2
112	8 3/4	3 1/4	---	8	2 1/2
309	6 1/2	---	1/2	---	2 1/4

### ORDERING INFORMATION

Description	Plain Bronze Standard Pkg.-1 pc.	Chrome Plated Bronze Standard Pkg.-1 pc.	Black Powder Coat Zinc Display Pkg.-5 bxs. 1 Pc. per box	Black Powder Coat Zinc Standard Pkg.-1 pc.
White All-Round	112 B00 PLB	112 B00 CHR	108 DP BLK**	108 000 BLK**
Red All-Round	112 R00 PLB	112 R00 CHR	108 DPR BLK	108 R00 BLK
Green All-Round	112 G00 PLB	112 G00 CHR	108 DPG BLK	108 G00 BLK
Yellow All-Round	112 M00 PLB	112 M00 CHR	-----	-----
White All-Round	309 B00 PLB	309 B00 CHR		
Red All-Round	309 R00 PLB	309 R00 CHR		
Green All-Round	309 G00 PLB	309 G00 CHR		
Yellow All-Round	309 M00 PLB	309 M00 CHR		

\*Base Removable for Flush Mounting.

\*\*These Lights Are Supplied with a Gray Tinted Globe.

### SPARE PARTS ORDERING INFORMATION

#### Spare Globes:

White, Cat. No. 106 000 WHT.  
 Gray, Cat. No. 106 000 GRY.  
 Red, Cat. No. 106 000 RED.  
 Green, Cat. No. 106 000 GRN.  
 Yellow, Cat. No. 106 000 YLW.

#### Required Bulbs:

12 Volts for Fig. 108 (2 per bag), Cat. No. 70 DP1 CLR.  
 12 Volts for White and Yellow Figs. 112 and 309, Cat. No. 340 005 FRD.  
 12 Volts for Red and Green Figs. 112 and 309, Cat. No. 340 006 FRD.  
 32 Volts for Fig. 108 (2 per bag), Cat. No. 70 DP2 CLR.  
 32 Volts for White and Yellow Figs. 112 and 309, Cat. No. 340 011 FRD.  
 32 Volts for Red and Green Figs. 112 and 309, Cat. No. 340 012 FRD.

Spare Medium Screw Base Socket, Cat. No. 226.

Spare Base and Gasket for Fig. 108, Cat. No. 222 DP BLK.



Figs. 362 & 371 — Frosted Globe, Cast Bronze, Plain or Chrome Plated

Double Contact Socket, Complete with 12 Volt Bulb.



Fig. 362



Fig. 371

### ORDERING INFORMATION

Vertical Height Inches	O.D. Base Inches	Plain Bronze Standard Pkg.-1 pc.	Chrome Plated Bronze Standard Pkg.-1 pc.	Screw Size	Tapped Pipe Size Inches	Weight Ounces
2 3/8	---	362 000 PLB	362 000 CHR	---	1/2	8
1 5/8	2 1/2	371 000 PLB	371 000 CHR	8 F.H.	---	10

Spare Bulbs (2 per bag), Cat. No. 337 011 DP.

Spare Globe, Cat. No. 248 000 FRD.

Spare Socket, Cat. No. 24 DP1.



## WHITE ALL-ROUND LIGHTS

FOR USE ON SAIL\* OR POWER DRIVEN VESSELS UNDER 20 METERS (65.6 ft.) IN LENGTH.

**2 Mile Visibility**  
**Complete with 12 Volt Bulb.**  
**Black Plastic Tops, Chrome Plated Zinc Bases**  
**3/4 Inch Anodized Aluminum Tubes**

**Fig. 1134 — White Translucent Globe, Fold-Down Adjustable Angle, Horizontal Mount Plastic Adapters for "V" or Flat Mount**

**Fig. 1137 — White Translucent Globe, Fold-Down Adjustable Angle, Vertical Mount Plastic Adapters for "V" or Flat Mount**

### Improved Mounting Brackets

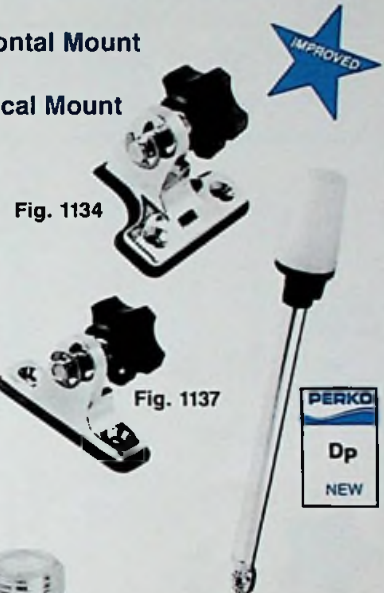

Fig. 1134

Fig. 1137



Vertical Height Inches	Dimensions Base Inches	ORDERING INFORMATION				
		Display Pkg.-5 cds. 1 Pc. per card	Std. Pkg.-5 bxs. 1 Pc. per box	OEM Pkg.	Screw Size	Weight Ounces
13 <sup>5</sup> / <sub>8</sub>	2 x 1 <sup>1</sup> / <sub>2</sub>	1134 DP CHR	1134 000 CHR	50	8	13
13 <sup>5</sup> / <sub>8</sub>	2 <sup>1</sup> / <sub>4</sub> x <sup>5</sup> / <sub>8</sub>	1137 DP CHR	1137 000 CHR	50	8	13

Spare Bulbs (2 per bag), Cat. No. 337 012 DP.

Spare Knob, Cat. No. 1144 A00 BLK.

Spare Globe, Cat. No. 201 DP WHT.

Spare Bracket with Knob and End Plug for Fig. No. 1134, Cat. No. 1052 DP CHR.

Spare Bracket with Knob and End Plug for Fig. No. 1137, Cat. No. 1054 DP CHR.

**Fig. 455 — Clear Fresnel Globe, Fixed Mount**  
 \*For Use on Power Driven Vessels Only

Vertical Height Inches	O.D. Base Inches	ORDERING INFORMATION				
		Display Pkg.-5 cds. 1 Pc. per card	Std. Pkg.-5 bxs. 1 Pc. per box	OEM Pkg.	Screw Size	Weight Ounces
4 <sup>1</sup> / <sub>2</sub>	2 <sup>1</sup> / <sub>16</sub>	455 DP1 CHR	455 001 CHR	50	8	12
11	2 <sup>1</sup> / <sub>16</sub>	455 DP2 CHR	455 002 CHR	50	8	16

Spare Bulbs (2 per bag), Cat. No. 337 011 DP.

Spare Globe, Cat. No. 248 DP CLR.



Fig. 455



**Fig. 1301 — White Translucent Globe, Fixed Mount**

Vertical Height Inches	Dimensions Base Inches	ORDERING INFORMATION				
		Display Pkg.-5 cds. 1 Pc. per card	Std. Pkg.-5 pcs. OEM Pkg.-50 pcs.	Screw Size	Weight Ounces	
7 <sup>1</sup> / <sub>8</sub>	1 x 2 <sup>5</sup> / <sub>8</sub>	1301 DP CHR	1301 000 CHR	8 R.H.	7	

Spare Bulbs (2 per bag), Cat. No. 337 012 DP.

Spare Globe, Cat. No. 201 DP WHT.



Fig. 1301



**Fig. 120 SWB — White Translucent Globe, Fixed Mount**

Vertical Height Inches	Dimensions Base Inches	ORDERING INFORMATION				
		Display Pkg.-5 cds. 1 Pc. per card	Std. Pkg.-5 pcs. OEM Pkg.-50 pcs.	Screw Size	Weight Ounces	
3 <sup>3</sup> / <sub>4</sub>	1 x 2 <sup>5</sup> / <sub>8</sub>	120 SWB DP1	120 SWB 12V	8 R.H.	4 <sup>1</sup> / <sub>2</sub>	

Spare Bulbs (2 per bag), Cat. No. 337 012 DP.

Spare Globe, Cat. No. 201 DP WHT.



Fig. 120 SWB



## WHITE ALL-ROUND LIGHTS

FOR USE ON SAIL OR POWER DRIVEN VESSELS UNDER 20 METERS (65.6 ft.) IN LENGTH.

Replacement Stow-A-Way Plug-In Type

2 Mile Visibility

White Translucent Globe, Black Plastic Top, Complete With 12 Volt Bulb  
3/4 Inch Diameter Anodized Aluminum Tube

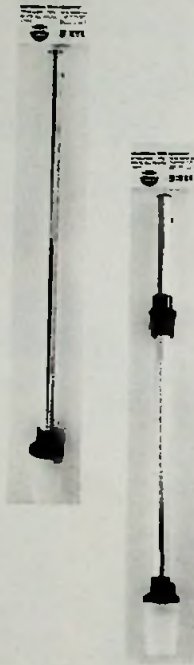

Fig. 1400

Fig. 1400 — Universal Replacement

ORDERING INFORMATION		
Approx. Length Inches	Display Pkg.-10 bags 1 Pc. per bag	Weight Pounds
24	1400 DP2 CHR	1/2
30	1400 DP3 CHR	5/8
36	1400 DP4 CHR	1 1/2
42	1400 DP5 CHR	1 3/4
48	1400 DP6 CHR	2
54	1400 DP7 CHR	2 1/4



Fig. 1600 — Replacement PERKO Lights with Locking Collar

ORDERING INFORMATION		
Approx. Length Inches	Display Pkg.-10 bags 1 Pc. per bag	Weight Pounds
24	1600 DP2 CHR	1/2
30	1600 DP3 CHR	5/8
36	1600 DP4 CHR	1 1/2
42	1600 DP5 CHR	1 3/4
48	1600 DP6 CHR	2
54	1600 DP7 CHR	2 1/4

Fig. 1600

## POLE STORAGE CLIPS FIG. 477



Fig. 477

Soft Rubber  
Fits 3/4 Inch Diameter Tubing

ORDERING INFORMATION			Weight per Pair Ounces
Display Pkg.-10 bags 1 Pr. per bag	OEM Pkg.-50 prs.	Screw Size	
477 DP BLK	477 000 BLK	8 P.H.	3



## HALYARD EYES FIGS. 234 & 235



Fig. 234

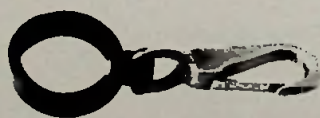

Fig. 235

Black Plastic  
Fits 3/4 Inch Diameter Tubing

Fig. 235 — Includes a Brass Snap

ORDERING INFORMATION	
Standard Pkg.-10 pcs.	Standard Pkg.-10 pcs.
234 000 BLK	235 000 BLK

## NAVIGATION LIGHT VERTICAL HEIGHTS

NOTE: Vertical Height "H" is Measured from the Center of the Bulb Filament to the Mounting Surface and May be Used as a Generalized Guide for the Selection of Lights in Accordance with the Vertical Light Separation Requirements of Navigation Regulations.

### BI-COLOR LIGHTS

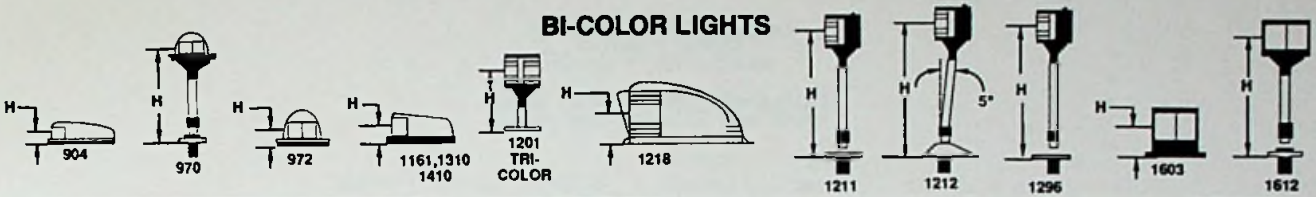

### BI-COLOR LIGHTS

FIG.	904	970	972	1161	1201	1211	1212	1218	1296	1310	1410	1603	1612
H	7/8	9 3/4	7/8	1	3 1/4	10	10 1/4	1 1/8	10	1	1	1 1/8	9 3/4

### WHITE ALL-ROUND LIGHTS

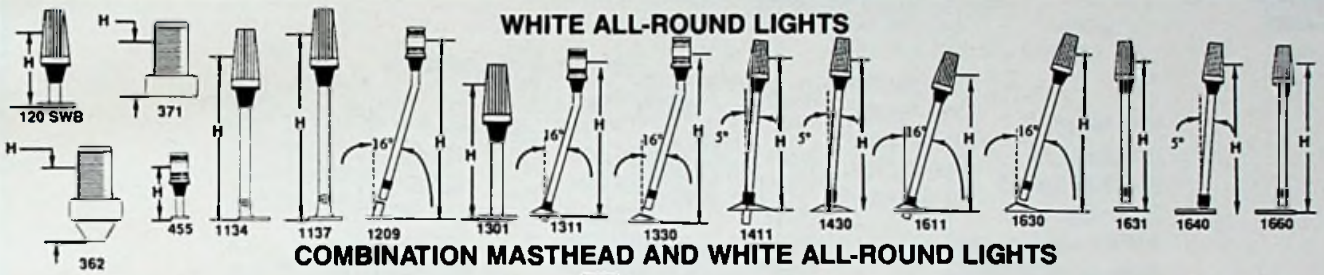

### COMBINATION MASTHEAD AND WHITE ALL-ROUND LIGHTS

		DIMENSIONS						
SIZE		1	2	3	4	5	6	7
FIG.	H	H	H	H	H	H	H	H
<b>WHITE ALL-ROUND LIGHTS</b>								
120 SWB	3 3/4							
362	2 3/8							
371	1 5/8							
455		4 1/2	11					
1134	13 5/8							
1137	13 3/8							
1209			21 3/8	28 3/8	34			
1301	7 1/8							
1311			20 1/2	26 3/8	32 1/2			
1330			20 1/2	26 3/8	32 1/2			
1411			21	27 1/4	33 1/2			
1430			21	27 1/4	33 1/2	40 3/4	46 3/4	51 3/4
1611			20 3/4	26 3/8	32 3/4			
1630			20 3/4	26 3/8	32 3/4	40	45 1/2	50 1/2
1631						40 1/4	46 3/4	
1640			20 3/8	27 1/8	33 1/4	40 1/2	46 1/2	51 1/2
1660						40 3/8	48 3/8	51 3/8
<b>COMBINATION MASTHEAD AND WHITE ALL-ROUND LIGHTS</b>								
1123			11 1/2	20 3/4				
1124			11 1/2	20 3/4				
1125					33 3/8			
1181	12 5/8							
1183	3 1/4							
1184	12 3/8							
1196		5 1/4	11 1/4					
1197	4							

### SIDE LIGHTS

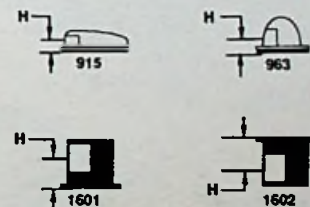

SIDE LIGHTS				
FIG.	915	963	1601	1602
H.	7/8	7/8	1 1/8	1 1/8

### MASTHEAD LIGHTS

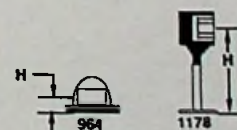

MASTHEAD LIGHTS		
FIG.	964	1178
H.	7/8	3 1/4

## NAVIGATION LIGHTS

FOR USE ON SAIL OR POWER DRIVEN VESSELS UNDER 12 METERS (39.4 ft.) IN LENGTH.

**Black Plastic**

**Complete with 12 Volt Bulb**

Fig.	Height Overall Inches	Projection Overall Inches	Width Inches	Screw Size	Weight Ounces
120 SWB	5 $\frac{1}{8}$ "*	—	2 $\frac{1}{2}$	8 R.H.	4 $\frac{1}{2}$
120 BMD	7	4 $\frac{3}{4}$	4 $\frac{1}{8}$	10	18 $\frac{1}{2}$
All Others	3 $\frac{5}{8}$	2 $\frac{1}{2}$	4 $\frac{1}{8}$	10	5

\*Vertical Height 3 $\frac{3}{4}$  Inches.



### ORDERING INFORMATION

Description:	Visibility Arc	Display Pkg.-5 bxs. 1 Pc. per box	Std. Pkg.-1 pc. OEM Pkg.-10 pcs.	Visibility Miles
Bi-Color Light	225°	120 BB DP1	120 BB 12V	1
Red Side Light	112 $\frac{1}{2}$ °	120 BP DP1	120 BP 12V	1
Green Side Light	112 $\frac{1}{2}$ °	120 BSD DP1	120 BSD 12V	1
White Masthead Light	225°	120 BM DP1	120 BM 12V	2
White Stern Light	135°	120 BSN DP1	120 BSN 12V	2
White All-Round Light	360°	120 SWB DP1	120 SWB 12V	2
Masthead/Deck Spreader Light	225°	120 BMD DP1	120 BMD 12V	2



Fig. 120 BSD



Fig. 120 BB



Fig. 120 BP



Fig. 120 BSN



Fig. 120 BM



Fig. 120 SWB



Fig. 120 BMD

### SPARE PARTS ORDERING INFORMATION

Spare Halogen Bulb for Deck Spreader Light, Cat. No. 68 12V 20W.

Spare Bulbs (2 per bag) for 120 SWB, Cat. No. 337 012 DP.

Spare Bulbs (2 per bag) for All Others, Cat. No. 69 DP CLR.

For Spare Lens and Shield Assembly, Replace the Last Three Digits of the Catalog Number with the Letters "LNS" (e.g., 120 BB LNS, for a Black Shield and Bi-Color Lens).

## NAVIGATION LIGHTS

FOR USE ON SAIL OR POWER DRIVEN VESSELS UNDER 12 METERS (39.4 ft.) IN LENGTH.

**Chrome Plated Brass  
Black Plastic Base**

**Complete with 12 Volt Bulb**

Height Overall Inches	Projection Overall Inches	Width Inches	Screw Size	Weight Ounces
3 $\frac{5}{8}$	2 $\frac{1}{2}$	4 $\frac{1}{8}$	10	5



### ORDERING INFORMATION

Description:	Visibility Arc	Display Pkg.-5 bxs. 1 Pc. per box	Std. Pkg.-1 pc. OEM Pkg.-10 pcs.	Visibility Miles
Bi-Color Light	225°	120 MB DP1	120 MB 12V	1
Red Side Light	112 $\frac{1}{2}$ °	120 MP DP1	120 MP 12V	1
Green Side Light	112 $\frac{1}{2}$ °	120 MSD DP1	120 MSD 12V	1
White Masthead Light	225°	120 MM DP1	120 MM 12V	2
White Stern Light	135°	120 MSN DP1	120 MSN 12V	2



Fig. 120 MSD



Fig. 120 MB



Fig. 120 MP



Fig. 120 MSN



Fig. 120 MM

### SPARE PARTS ORDERING INFORMATION

Spare Bulbs (2 per bag), Cat. No. 69 DP CLR.

For Spare Lens and Shield Assembly, Replace the Last Three Digits of the Catalog Number with the Letters "LNS" (e.g., 120 MB LNS, for a Chrome Plated Brass Shield and Bi-Color Lens).

## MOUNTING BRACKETS FIG. 120

**300 Series Stainless Steel  
Black Plastic Mounting Plate**

### ORDERING INFORMATION

Description:	Standard Pkg.-1 pc.	Screw Size
Right Angle Bracket	120 RB BKT	8 R.H.
Masthead Bracket	120 VMB BKT	8 R.H.
Straight Pulpit Bracket	120 PB BKT	8 R.H.
Offset Mast Bracket	120 PBO BKT	8 R.H.

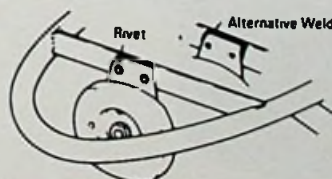

Typical Pulpit mounting Cat. No. 120 PB BKT

### MAST MOUNTING Cat. No. 120 VMB BKT

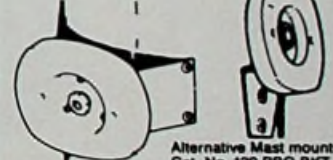

Alternative Mast mounting  
Cat. No. 120 PBO BKT



Pushpit Pulpit mounting  
Cat. No. 120 PB BKT

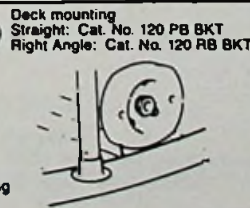

Typical mounting for  
Cruiser  
Masthead Lantern  
Cat. No.  
120 RB BKT



## NAVIGATION LIGHTS

FOR USE ON SAIL OR POWER DRIVEN VESSELS UNDER 12 METERS (39.4 ft.) IN LENGTH.

**White Plastic,  
Black Plastic Base**

**Complete with 12 Volt Bulb**

Height Overall Inches	Projection Overall Inches	Width Inches	Screw Size	Weight Ounces
3 $\frac{5}{8}$	2 $\frac{1}{2}$	4 $\frac{1}{8}$	10	5



### ORDERING INFORMATION

Description:	Visibility Arc	Display Pkg.-5 bxs. 1 Pc. per box	Std. Pkg.-1 pc. OEM Pkg.-10 pcs.	Visibility Miles
Bi-Color Light	225°	120 WB DP1	120 WB 12V	1
Red Side Light	112 $\frac{1}{2}$ °	120 WP DP1	120 WP 12V	1
Green Side Light	112 $\frac{1}{2}$ °	120 WSD DP1	120 WSD 12V	1
White Masthead Light	225°	120 WM DP1	120 WM 12V	2
White Stern Light	135°	120 WSN DP1	120 WSN 12V	2



Fig. 120 WSD



Fig. 120 WB



Fig. 120 WP



Fig. 120 WM



Fig. 120 WSN

### SPARE PARTS ORDERING INFORMATION

Spare Bulbs (2 per bag), Cat. No. 69 DP CLR.  
For Spare Lens and Shield Assembly, Replace the Last Three Digits of the Catalog Number with the Letters "LNS" (e.g., 120 WB LNS, for a White Shield and Bi-Color Lens).

## NAVIGATION LIGHTS

FOR USE ON SAIL OR POWER DRIVEN VESSELS UNDER 20 METERS (65.6 ft.) IN LENGTH.

**Top Mount**  
**Black Plastic with Stainless Steel Mounted Bracket**  
**Complete with 12, 24 or 32 Volt Bulb**

Height Overall Inches	Projection Inches	Height Lens Inches	Screw Size	Weight Ounces
4 <sup>13</sup> / <sub>16</sub>	3 <sup>5</sup> / <sub>16</sub>	2 <sup>3</sup> / <sub>4</sub>	8	12 <sup>1</sup> / <sub>2</sub>

**ORDERING INFORMATION — For 12 Volt Lights**

Description	Visibility Arc	Display Pkg.-5 pkgs. 1 Pc. per pkg.	Std. Pkg.-1 pc. OEM Pkg.-10 pcs.	Visibility Miles	Replacement Bulb
Bi-Color Light	225°	200 BT DP1	200 BT 12V	2	375 12V 25W
Red Side Light	112 <sup>1</sup> / <sub>2</sub> °	200 PT DP1	200 PT 12V	2	375 12V 25W
Green Side Light	112 <sup>1</sup> / <sub>2</sub> °	200 SDT DP1	200 SDT 12V	2	375 12V 25W
White Masthead Light	225°	200 MT DP1	200 MT 12V	3	375 12V 25W
White Stern Light	135°	200 SNT DP1	200 SNT 12V	2	375 12V 10W
Yellow Towing Light	135°	200 TWT DP1	200 TWT 12V	2	375 12V 10W

**ORDERING INFORMATION — For 24 Volt Lights**

Replace the "DP1" with "DP2" For Display Package or the "12V" with "24V" For Standard Package (e.g., 200 BT DP2 or 200 BT 24V).

For the Replacement Bulb, Replace the "12V" with "24V" (e.g., 375 24V 25W).

**ORDERING INFORMATION — For 32 Volt Lights**

Replace the "DP1" with "DP3" For Display Package or the "12V" with "32V" For Standard Package (e.g., 200 BT DP3 or 200 BT 32V).

For the Replacement Bulb, Replace the "12V" with "32V" (e.g., 375 32V 25W).

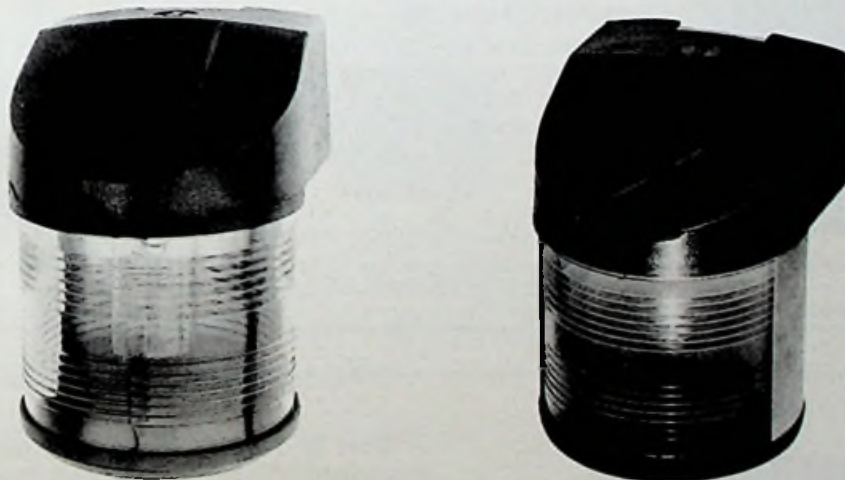

**200 SERIES TOP MOUNT**



**SPARE LENS ORDERING INFORMATION**

Spare Lens Assembly Part Numbers are Determined by Replacing the Last Three Digits of the Catalog Number with the Letters "LNS" (e.g., 200 BT LNS, for a Bi-Color Top Mount Lens Assembly).

## NAVIGATION LIGHTS

FOR USE ON SAIL OR POWER DRIVEN VESSELS UNDER 20 METERS (65.6 ft.) IN LENGTH.

### Base Mount Black Plastic Complete with 12, 24 or 32 Volt Bulb

Height Overall Inches	O.D. Base Inches	Height Lens Inches	Screw Size	Weight Ounces
4 $\frac{7}{8}$	3 $\frac{5}{16}$	2 $\frac{3}{4}$	10	9 $\frac{1}{2}$

#### ORDERING INFORMATION — For 12 Volt Lights

Description	Visibility Arc	Display Pkg.-5 Pkgs. 1 Pc. per pkg.	Std. Pkg.-1 pc. OEM Pkg.-10 pcs.	Visibility Miles	Replacement Bulb
Bi-Color Light	225°	200 BB DP1	200 BB 12V	2	375 12V 25W
Red Side Light	112 $\frac{1}{2}$ °	200 PB DP1	200 PB 12V	2	375 12V 25W
Green Side Light	112 $\frac{1}{2}$ °	200 SDB DP1	200 SDB 12V	2	375 12V 25W
White Masthead Light	225°	200 MB DP1	200 MB 12V	3	375 12V 25W
White Stern Light	135°	200 SNB DP1	200 SNB 12V	2	375 12V 10W
Yellow Towing Light	135°	200 TWB DP1	200 TWB 12V	2	375 12V 25W
White All-Round Light	360°	200 SWB DP1	200 SWB 12V	2	375 12V 10W
Red All-Round Light	360°	200 SRB DP1	200 SRB 12V	2	375 12V 25W
Green All-Round Light	360°	200 SGB DP1	200 SGB 12V	2	375 12V 25W
Tri-Color Light*	360°	200 TB DP1	200 TB 12V	2	375 12V 25W

\*For Use on Vessels Under Sail Alone.



#### ORDERING INFORMATION — For 24 Volt Lights

Replace the "DP1" with "DP2" For Display Pkg. or the "12V" with "24V" For Standard Pkg.

(e.g., 200 BB DP2 or 200 BB 24V).

For the Replacement Bulb, Replace the "12V" with "24V" (e.g., 375 24V 25W and 375 24V 10W).

#### ORDERING INFORMATION — For 32 Volt Lights

Replace the "DP1" with "DP3" For Display Pkg. or the "12V" with "32V" For Standard Pkg.

(e.g., 200 BB DP3 or 200 BB 32V).

For the Replacement Bulb, Replace the "12V" with "32V" (e.g., 375 32V 25W and 375 32V 10W).



#### SPARE LENS ORDERING INFORMATION

Spare Lens Assembly Part Numbers are Determined by Replacing the Last Three Digits of the Catalog Number with the Letters "LNS" (e.g., 200 BB LNS, for a Bi-Color Base Mount Lens Assembly).



## PIPE MOUNTING BRACKET FIG. 222

Cast Zinc with Gloss Black PERKO-KOTE Finish  
Complete with Screws and Soft Black Mounting Gasket  
for Mounting Light to Bracket.

For Use on All 200 Series Base Mount Lights.

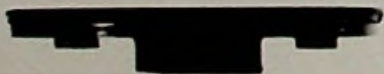
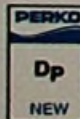

Fig. 222

#### ORDERING INFORMATION

O.D. Overall Inches	Tapped Pipe Size Inches	Display Pkg.-5 bags 1 Pc. per bag
3 $\frac{5}{16}$	$\frac{1}{2}$	222 DP BLK





## ALL-ROUND LIGHTS

FOR USE ON SAIL OR POWER DRIVEN VESSELS UNDER 20 METERS (65.6 ft.) IN LENGTH.

**Halyard Mount  
Black Plastic with Stainless Steel Mounting Hardware.  
Complete with 12, 24 or 32 Volt Bulb**

Height Overall Inches	O.D. Inches	Height Lens Inches	Weight Ounces
7¼	3⅝	2¾	9

### ORDERING INFORMATION — For 12 Volt Lights

Description	Display Pkg.-5 bxs. 1 Pc. per box	Std. Pkg.-1 pc. OEM Pkg.-10 pcs.	Visibility Miles	Replacement Bulb
White All-Round Light	200 SWH DP1	200 SWH 12V	2	375 12V 10W
Red All-Round Light	200 SRH DP1	200 SRH 12V	2	375 12V 25W
Green All-Round Light	200 SGH DP1	200 SGH 12V	2	375 12V 25W

### ORDERING INFORMATION — For 24 Volt Lights

Replace the "DP1" with "DP2" For Display Package or the "12V" with "24V" For Standard Package (e.g., 200 SWH DP2 or 200 SWH 24V).

For the Replacement Bulb, Replace the "12V" with "24V" (e.g., 375 24V 25W).

### ORDERING INFORMATION — For 32 Volt Lights

Replace the "DP1" with "DP3" For Display Package or the "12V" with "32V" For Standard Package (e.g., 200 SWH DP3 or 200 SWH 32V).

For the Replacement Bulb, Replace the "12V" with "32V" (e.g., 375 32V 25W).



Fig. 200 SWH



Fig. 200 SRH



200 SGH



### SPARE LENS ORDERING INFORMATION

Spare Lens Assembly Part Numbers are Determined by Replacing the Last Three Digits of the Catalog Number with the Letters "LNS" (e.g., 200 SWH LNS, for a White Halyard Mount Lens Assembly).

## RAIL MOUNTING BRACKET FIG. 200M

**300 Series Stainless Steel  
Complete with Screws for Mounting Light to Bracket.**

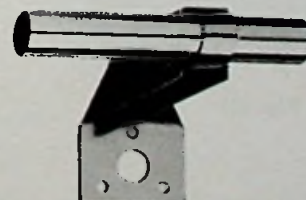

Fig. 200M

### ORDERING INFORMATION

For Rail O.D. Inches	Standard Pkg.-1 pc.	Weight Ounces
¾-1	200 M STS	5½

## DUAL PURPOSE ALL-ROUND LIGHTS

FOR USE ON SAIL OR POWER DRIVEN VESSELS UNDER 20 METERS (65.6 ft.) IN LENGTH.

**Base Mount  
Black Plastic**

**Complete with Two 12, 24 or 32 Volt Bulbs**



Height Overall Inches	O.D. Inches	Height Lens Inches	Screw Size	Weight Ounces
8 <sup>5</sup> / <sub>16</sub>	3 <sup>5</sup> / <sub>16</sub>	2 <sup>3</sup> / <sub>4</sub>	10	14

### ORDERING INFORMATION — For 12 Volt Lights

Description	Display Pkg.-5 pkgs. 1 Pc. per pkg.	Std. Pkg.-1 pc. OEM Pkg.-10 pcs.	Visibility Miles	Replacement Bulbs
Tri-Color/White All-Round Light*	200 TAB DP1	200 TAB 12V	2/2	375 12V 25W/10W
Masthead/White All-Round Light	200 MAB DP1	200 MAB 12V	3/2	375 12V 25W/10W
Green/Red All-Round Light	200 GRB DP1	200 GRB 12V	2/2	375 12V 25W/10W

\*For Use on Vessels Under Sail Alone.



Fig. 200 MAB

### ORDERING INFORMATION — For 24 Volt Lights

Replace the "DP1" with "DP2" For Display Package or the "12V" with "24V" For Standard Package (e.g., 200 TAB DP2 or 200 TAB 24V).

For the Replacement Bulb, Replace the "12V" with "24V" (e.g., 375 24V 25W and 375 24V 10W).

### ORDERING INFORMATION — For 32 Volt Lights

Replace the "DP1" with "DP3" For Display Package or the "12V" with "32V" For Standard Package (e.g., 200 TAB DP3 or 200 TAB 32V).

For the Replacement Bulb, Replace the "12V" with "32V" (e.g., 375 32V 25W and 375 32V 10W).



Fig. 200 TAB

**NOTE: The Above Lights are Used with Other Lights, Therefore Both Compartments Are Never to be Illuminated at the Same Time.**

### SPARE LENS ORDERING INFORMATION

Spare Lens Part Numbers are Determined by Replacing the Last Three Figures of the Catalog Number with the Letters "LNS" (e.g., 200 TAB LNS, for a Tri-Color/White All-Round Lens).

## MEAL AND ABSENT LIGHT FIG. 329

**Chrome Plated Bronze**

**Double Contact Bayonet Sockets, Bulbs Not Included**



Fig. 329

Blue Owner Absent Light and White Mealtime Light,  
Replace Blue and White Flags for Use at Night.  
For Mounting on Main Starboard Yardarm.

### ORDERING INFORMATION

Dimensions Base Inches	Length Overall Inches	O.D. Globe Inches	Standard Pkg.-1 pc.	Screw Size	Weight Pounds
3 <sup>3</sup> / <sub>8</sub> x 1 <sup>3</sup> / <sub>4</sub>	9	2 <sup>1</sup> / <sub>2</sub>	329 000 CHR	8	2

Required Bulbs (2 per bag) For 12 Volt Use, Cat. No. 337 011 DP.  
Required Bulbs For 32 Volt Use, Cat. No. 337 018 CLR.  
Spare Socket, Cat. No. 24 DP1.

Spare Blue Globe, Cat. No. 250 000 BLU.  
Spare White Globe, Cat. No. 250 000 WHT.

## NAVIGATION LIGHTS

FOR USE ON SAIL OR POWER DRIVEN VESSELS UNDER 20 METERS (65.6 ft.) IN LENGTH.

**Cast Zinc with Gloss Black PERKO•KOTE Finish  
For 12 or 32 Volts, Bulb Not Included**

Fig.	Height Overall Inches	Height Lens Inches	Tapped Pipe Size	Screw Size	Weight Pounds
108	6	5	½"	10	1¾
All Others	5¼	4¼	—	10	2



### ORDERING INFORMATION

Description	Visibility Arc	Display Pkg.-5 bxs. 1 Pc. per box	Standard Pkg.-1 pc.	Visibility Miles
Side Lights (Pair)	112½°	109 DP BLK	109 000 BLK	2
Red Side Light	112½°	109 DPR BLK	109 R00 BLK	2
Green Side Light	112½°	109 DPG BLK	109 G00 BLK	2
White Masthead Light	225°	110 DP BLK	110 000 BLK	3
White Stern Light	135°	111 DP BLK	111 000 BLK	2
Yellow Towing Light	135°	111 DPM BLK	111 M00 BLK	2
White All-Round Light**	360°	108 DP BLK	108 000 BLK	2
Red All-Round Light	360°	108 DPR BLK	108 R00 BLK	2
Green All-Round Light	360°	108 DPG BLK	108 G00 BLK	2

\*Base Removable for Flush Mounting.

\*\*This Light is Supplied with a Gray Tinted Globe.



Fig. 109



Fig. 109



Fig. 108



Fig. 110



Fig. 111

### SPARE PARTS ORDERING INFORMATION

#### Spare Lenses:

112½° Fig. No. 259 H02, Specify Color.  
135° Fig. No. 269 H02, Specify Color.  
225° Cat. No. 256 H02 WHT.  
360° Fig. No. 106 000, Specify Color.

Spare Base and Gasket for Fig. No. 108, No. 222 DP BLK.

#### Required Bulbs:

For 12 Volts (2 per bag), Cat. No. 70 DP1 CLR.  
For 32 Volts (2 per bag), Cat. No. 70 DP2 CLR.

## NAVIGATION LIGHTS

FOR USE ON POWER DRIVEN VESSELS AS SPECIFIED BELOW.

**Sheet Metal, Galvanized Steel or Polished Brass  
Bottom Opening, Complete with Mounting Bracket,  
For 12 or 32 Volts, Bulb Not Included**

	Height Overall Inches	Height Lens Inches	Screw Size	Weight Pounds
For Vessels Under 12 Meters (39.4 ft.)	5	4¼	6	1½
For Vessels 12 to 20 Meters (65.6 ft.)	6	5⅞	6	2

### ORDERING INFORMATION

For Vessels Under 12 Meters (39.4 ft.) in Length (12 Volts Only).

Description	Visibility Arc	Galvanized Steel	Polished Brass	Visibility Miles
Side Lights (Pair)	112½°	91 F02 GAL	91 F02 POL	1
Red Side Light	112½°	91 RF2 GAL	91 RF2 POL	1
Green Side Light	112½°	91 GF2 GAL	91 GF2 POL	1
White Masthead Light	225°	98 F02 GAL	98 F02 POL	2
White Stern Light	135°	99 F02 GAL	99 F02 POL	2

### ORDERING INFORMATION

For Vessels 12 Meters (39.4 ft.) to 20 Meters (65.6 ft.) in Length (12 or 32 Volts).

Description	Visibility Arc	Galvanized Steel	Polished Brass	Visibility Miles
Side Lights (Pair)	112½°	91 F03 GAL	91 F03 POL	2
Red Side Light	112½°	91 RF3 GAL	91 RF3 POL	2
Green Side Light	112½°	91 GF3 GAL	91 GF3 POL	2
White Masthead Light	225°	98 F03 GAL	98 F03 POL	3
White Stern Light	135°	99 F03 GAL	99 F03 POL	2



Fig. 91



Fig. 98



Fig. 99

### SPARE PARTS ORDERING INFORMATION

#### Spare Lenses:

112½° Fig. No. 259 CL2 or CL3, Specify Color.  
135° Fig. No. 269 CL2 or CL3, Specify Color.  
225° Fig. No. 256 CL2 or CL3, Specify Color.  
Spare Mounting Bracket, Cat. No. 92 000 GAL or PLB.  
Spare Electric Adapter for No. 2, Cat. No. 138 F02.  
Spare Electric Adapter for No. 3, Cat. No. 138 F03.

#### Required Bulbs:

Bulbs for No. 2 (12 Volts-2 per bag), Cat. No. 70 DP0 CLR.  
Bulbs for No. 3 (12 Volts-2 per bag), Cat. No. 70 DP1 CLR.  
Bulbs for No. 3 (32 Volts-2 per bag), Cat. No. 70 DP2 CLR.

## NAVIGATION LIGHTS

FOR USE ON POWER DRIVEN VESSELS AS SPECIFIED BELOW.

**Sheet Metal, Galvanized Steel or Polished Brass  
Bottom Opening, Complete with Mounting Bracket,  
For 12 or 32 Volts, Bulb Not Included**

	Height Overall Inches	Height Lens Inches	Screw Size	Weight Pounds
For Vessels Under 12 Meters (39.4 ft.)	7¼	4¼	10	2½
For Vessels 12 to 20 Meters (65.6 ft.)	8½	5⅝	10	3½

### ORDERING INFORMATION

For Use on Vessels Under 12 Meters (39.4 ft.) in Length (12 Volts Only).

Description	Visibility Arc	Galvanized Steel	Polished Brass	Visibility Miles
Side Lights (Pair)	112½°	4 F02 GAL	4 F02 POL	1
Red Side Light	112½°	4 RF2 GAL	4 RF2 POL	1
Green Side Light	112½°	4 GF2 GAL	4 GF2 POL	1
White Masthead Light	225°	5 F02 GAL	5 F02 POL	2
White Stern Light	135°	7 F02 GAL	7 F02 POL	2

### ORDERING INFORMATION

For Use on Vessels 12 Meters (39.4 ft.) to 20 Meters (65.6 ft.) in Length (12 or 32 Volts).

Description:	Visibility Arc	Galvanized Steel	Polished Brass	Visibility Miles
Side Lights (Pair)	112½°	4 F03 GAL	4 F03 POL	2
Red Side Light	112½°	4 RF3 GAL	4 RF3 POL	2
Green Side Light	112½°	4 GF3 GAL	4 GF3 POL	2
White Masthead Light	225°	5 F03 GAL	5 F03 POL	3
White Stern Light	135°	7 F03 GAL	7 F03 POL	2
Yellow Towing Light	135°	7 MF3 GAL	7 MF3 POL	2



Fig. 7F  
Fig. 7MF



Fig. 4F



Fig. 5F  
Fig. 5MF

### SPARE PARTS ORDERING INFORMATION

#### Spare Lenses:

112½° Fig. No. 259 CL2 or CL3, Specify Color.  
135° Fig. No. 269 CL2 or CL3, Specify Color.  
225° Fig. No. 256 CL2 or CL3, Specify Color.  
Spare Mounting Bracket, Cat. No. 131 000 GAL or PLB.  
Spare Electric Adapter for No. 2, Cat. No. 290 F02.  
Spare Electric Adapter for No. 3, Cat. No. 290 F03.

#### Required Bulbs:

Bulbs for No. 2 (12 Volts-2 per bag), Cat. No. 70 DP0 CLR.  
Bulbs for No. 3 (12 Volts-2 per bag), Cat. No. 70 DP1 CLR.  
Bulbs for No. 3 (32 Volts-2 per bag), Cat. No. 70 DP2 CLR.

## NAVIGATION LIGHTS

FOR USE ON POWER DRIVEN VESSELS 20 METERS (65.6 ft.) TO 50 METERS (164.0 ft.) IN LENGTH.

### BLACK PLASTIC

Complete with Pre-Wired Double Contact Socket and  
3 Feet of 16/3-SJO Cable For 12, 24, 32 or 120 Volts.  
Watertight Access Cap for Rebulbing and Cleaning.  
Bulb Not Included.

Height Overall Inches	Height Lens Inches	Screw Size	Weight Pounds
7½	4½	¼	3⅛

### ORDERING INFORMATION

Description	Visibility Arc	Visibility Miles	Cat. No.
Red Side Light	112½°	2	1127 RA0 BLK
Green Side Light	112½°	2	1127 GA0 BLK
White Masthead Light	225°	5	1128 A00 BLK
White Stern Light*	135°	2	1129 A00 BLK
Yellow Towing Light	135°	2	1129 MA0 BLK
White All-Round Light*	360°	2	1130 A00 BLK
White All-Round Light**	360°	5	1130 HA0 BLK
Red All-Round Light	360°	2	1130 RA0 BLK
Green All-Round Light	360°	2	1130 GA0 BLK
Yellow All-Round Light	360°	2	1130 MA0 BLK

\*These lights are supplied with a Gray Tinted Lens.

\*\*For Great Lakes use.



Fig. 1127



Fig. 1128



Fig. 1129



Fig. 1130

### IMPORTANT BULB DATA

To comply with U.L. Standard 1104, the lights listed on this page must use a PERKO Fig. No. 374 bulb.

### SPARE PARTS ORDERING INFORMATION

#### Spare Lens Assemblies:

Red, Cat. No. 249 000 RED.  
Green, Cat. No. 249 000 GRN.  
White, Cat. No. 249 000 CLR.  
Gray, Cat. No. 249 000 GRY.  
Yellow, Cat. No. 249 000 YLW.

Spare Double Contact Socket, Cat. No. 134.  
Spare Access Cap, O-Ring and Retainer, Cat. No. 1105 000 BLK.  
Spare O-Ring for Cap, Cat. No. 1119.

#### Required Bulbs:

12 Volts, Cat. No. 374 001 CLR.  
24 Volts, Cat. No. 374 002 CLR.  
32 Volts, Cat. No. 374 003 CLR.  
120 Volts, Cat. No. 374 004 CLR.

## NAVIGATION LIGHTS

FOR USE ON SAIL\* OR POWER DRIVEN VESSELS AS SPECIFIED BELOW.

**Oil or Electric  
Sheet Metal, Galvanized Steel or Polished Brass**

Bottom Opening, Complete with Oil Fount or Electric Socket  
and Mounting Bracket. Bulb Not Included.  
**Oil Lights For Emergency Use Only.**

	Height Overall Inches	Height Lens Inches	Screw Size	Weight Pounds
For Vessels Under 12 Meters (39.4 ft.)	10½	4¼	10	3
For Vessels 12 to 20 Meters (65.6 ft.)	12½	5⅝	10	3½

### ORDERING INFORMATION

Oil Lights For Use on Vessels Under 12 Meters (39.4 ft.) In Length.

Description	Visibility Arc	Galvanized Steel	Polished Brass	Visibility Miles
Side Lights (Pair)	112½°	17 000 GAL	17 000 POL	1
Red Side Light	112½°	17 R00 GAL	17 R00 POL	1
Green Side Light	112½°	17 G00 GAL	17 G00 POL	1
White Masthead Light	225°	18 000 GAL	18 000 POL	2
White Stern Light	135°	97 000 GAL	97 000 POL	2



Fig. 17  
Fig. 19

### ORDERING INFORMATION

Oil Lights For Use on Vessels 12 Meters (39.4 ft.) to 20 Meters (65.6 ft.) In Length.

Description:	Visibility Arc	Galvanized Steel	Polished Brass	Visibility Miles
Side Lights (Pair)	112½°	19 000 GAL	19 000 POL	2
Red Side Light	112½°	19 R00 GAL	19 R00 POL	2
Green Side Light	112½°	19 G00 GAL	19 G00 POL	2
White Masthead Light	225°	20 000 GAL	20 000 POL	3
White Stern Light	135°	102 000 GAL	102 000 POL	2
Yellow Towing Light	135°	102 M00 GAL	102 M00 POL	2



Fig. 18  
Fig. 20

\*NOTE: All of the Above Lights May Be Ordered For Electric Use on Power Driven Vessels Only.  
Specify by Replacing the first "0" in the Center Group of the Catalog Number with an "F"  
(e.g., 17 F00 POL, for an Electric Polished Brass Pair of Side Lights).



Fig. 97  
Fig. 102

### SPARE PARTS ORDERING INFORMATION

#### Spare Lenses:

112½° Fig. No. 259 CL2 or CL3, Specify Color.  
135° Fig. No. 269 CL2 or CL3, Specify Color.  
225° Fig. No. 256 CL2 or CL3, Specify Color.  
Spare Mounting Bracket, Cat. No. 131 000 GAL or PLB.  
Spare Electric Adapter for 10" Lights, Cat. No. 290 F02.  
Spare Electric Adapter for 12" Lights, Cat. No. 290 F03.

#### Required Bulbs for Electric Use:

Bulbs for 10" Lights (12 Volt-2 per bag), Cat. No. 70 DP0 CLR.  
Bulbs for 12" Lights (12 Volt-2 per bag), Cat. No. 70 DP1 CLR.  
Bulbs for 12" Lights (32 Volt-2 per bag), Cat. No. 70 DP2 CLR.  
Spare Burner, Cat. No. 246 000 PLB.  
Spare Wick, Cat. No. 302 00A.  
Spare Oil Fount, Cat. No. 286 000 PLB.

## WHITE ALL-ROUND LIGHTS FIGS. 02 & 06

FOR USE ON SAIL OR POWER DRIVEN VESSELS UNDER 20 METERS (65.6 ft.) IN LENGTH.

**Oil or Electric  
Sheet Metal, Galvanized Steel or Polished Brass**

Bottom Opening, Complete with Double Contact Bayonet  
Electric Socket or Oil Fount. Bulb Not Included.

*Oil Lights For Emergency Use Only.*

### ORDERING INFORMATION

Description	Height Overall Inches	Height Lens Inches	Galvanized Steel	Polished Brass	Weight Pounds
Fig. 02, Electric	8 <sup>5</sup> / <sub>8</sub>	3 <sup>5</sup> / <sub>16</sub>	-----	02 A00 POL	3 <sup>1</sup> / <sub>4</sub>
Fig. 02, Oil	8 <sup>5</sup> / <sub>8</sub>	3 <sup>5</sup> / <sub>16</sub>	-----	02 000 POL	3 <sup>1</sup> / <sub>4</sub>
Fig. 06, Electric	11 <sup>3</sup> / <sub>4</sub>	4 <sup>1</sup> / <sub>4</sub>	06 A00 GAL	06 A00 POL	4 <sup>1</sup> / <sub>4</sub>
Fig. 06, Electric*	11 <sup>3</sup> / <sub>4</sub>	4 <sup>1</sup> / <sub>4</sub>	06 B00 GAL	06 B00 POL	4 <sup>1</sup> / <sub>4</sub>
Fig. 06, Oil	11 <sup>3</sup> / <sub>4</sub>	4 <sup>1</sup> / <sub>4</sub>	06 000 GAL	06 000 POL	4 <sup>1</sup> / <sub>4</sub>

\*With Medium Screw Base Electrical Socket.

Spare Lens for Fig. No. 02, Cat. No. 261 JR0 CLR for Oil, or 261 JR0 FRD for Electric.  
Spare Lens for Fig. 06, Cat. No. 261 SR0 CLR for Oil, or 261 SR0 FRD for Electric.  
Spare Double Contact Bayonet Bulbs (2 per bag), Cat. No. 337 012 CLR.  
Spare Medium Screw Base Bulb, Cat. No. 340 005 FRD.  
Spare Double Contact Socket, Cat. No. 276 002.  
Spare Oil Fount for Fig. No. 02, Cat. No. 287 000 PLB.  
Spare Oil Fount for Fig. No. 06, Cat. No. 286 000 PLB.  
Spare Burner for Fig. No. 02, Cat. No. 246 000 PLB.  
Spare Burner for Fig. No. 06, Cat. No. 231 000 PLB.  
Spare Wick for Both, Cat. No. 302 00A.  
Spare Chimney for Fig. No. 06, Cat. No. 230 000 CLR.



Fig. 02



Fig. 06

## ELECTRIC ADAPTERS FOR THE ABOVE LIGHTS

**Brass**



Fig. 292



Fig. 291

Fig. 291 — For Double Contact Bayonet Base Bulb in Fig. 06  
Fig. 292 — For Medium Screw Base Bulb in Fig. 06  
Fig. 293 — For Double Contact Bayonet Base Bulb in Fig. 02



Fig. 293

### ORDERING INFORMATION

O.D. Overall Inches	I.D. Light Opening Inches	Standard Pkg.-1 pc.
3 <sup>5</sup> / <sub>8</sub>	3 <sup>3</sup> / <sub>16</sub>	291 003 PLB
3 <sup>5</sup> / <sub>8</sub>	3 <sup>3</sup> / <sub>16</sub>	292 000 PLB
4 <sup>1</sup> / <sub>2</sub>	4	293 000 PLB



## WHITE ALL-ROUND LIGHTS

FOR USE ON SAIL OR POWER DRIVEN VESSELS UNDER 20 METERS (65.6 ft.) IN LENGTH.

### Replacement Stow-A-Way Plug-In Type

2 Mile Visibility

White Translucent Globe, Black Plastic Top, Complete With 12 Volt Bulb  
3/4 Inch Diameter Anodized Aluminum Tubes

Fig. 1400 — Universal Replacement

Approx. Length Inches	ORDERING INFORMATION	
	Display Pkg.-10 bags 1 Pc. per bag	Weight Pounds
24	1400 DP2 CHR	1/2
30	1400 DP3 CHR	5/8
36	1400 DP4 CHR	1 1/2
42	1400 DP5 CHR	1 3/4
48	1400 DP6 CHR	2
54	1400 DP7 CHR	2 1/4



Fig. 1400 Fig. 1600



Fig. 1600 — Replacement PERKO Lights with Locking Collar

Approx. Length Inches	ORDERING INFORMATION	
	Display Pkg.-10 bags 1 Pc. per bag	Weight Pounds
24	1600 DP2 CHR	1/2
30	1600 DP3 CHR	5/8
36	1600 DP4 CHR	1 1/2
42	1600 DP5 CHR	1 3/4
48	1600 DP6 CHR	2
54	1600 DP7 CHR	2 1/4

### SPARE BASES FOR PERKO POLE LIGHTS

Locking Collar Included with Base Allows Interchangeability with Discontinued Style Bases.

#### Plug-In Type

Fig. 1059 P00 Fits: 1330 & 1630 Series	Fig. 1045 P00 Fits: 940, 970 1211*, 1612 1631 Series	Fig. 1060 P00 Fits: 1212*, 1430 Series
--	--	--



#### Telescoping Type

Fig. 1059 T00 Fits: 1311 & 1611 Series	Fig. 1060 T00 Fits: 1411 Series
--	---------------------------------------



#### ORDERING INFORMATION

Base Type	Length Overall Inches	Width Overall Inches	Insert Type	Discontinued Style Base Cat. No.	Replacement Style Base Display Pkg.-5 bgs. 1 Pc. per bag	Replacement Style Base Standard Pkg.-5 pcs.	Tube Angle Degrees
Telescoping	3 3/8	1 11/16	None	1156 000 CHR	1059 T00 DP	1059 T00 CHR	26
Telescoping	3 3/4	1 5/8	None	1026 T00 CHR	1059 T00 DP	1059 T00 CHR	16
Telescoping	3 3/4	1 3/4	Black	1027 T00 CHR	1060 T00 DP	1060 T00 CHR	5
Telescoping	3 3/4	1 3/4	Teak**	1027 T00 CHR	1060 T00 DP	1060 T00 CHR	5
Plug-In	2 1/4 O.D.		None	1023 P00 CHR	1045 P00 DP	1045 P00 CHR	0
Plug-In	3 3/8	1 11/16	None	1330 000 99A	1059 P00 DP	1059 P00 CHR	26
Plug-In	3 3/4	1 3/8	None	1026 P00 CHR	1059 P00 DP	1059 P00 CHR	16
Plug-In	3 3/4	1 3/4	Black	1027 P00 CHR	1060 P00 DP	1060 P00 CHR	5
Plug-In	3 3/4	1 3/4	Teak**	1027 T00 CHR	1060 P00 DP	1060 P00 CHR	5
Plug-In	3 3/8	2 1/4	None		1209 DP 99A	1209 000 99A	16

\*Specify 3-Contact Base (e.g. 1045 300 for Fig. No. 1211 or 1060 3B0 for Fig. No. 1212).

\*\*Teak Insert Bases No Longer Available, Substitute Black Insert Bases.

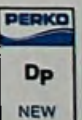

## SPARE PARTS

FOR NAVIGATION LIGHTS ON VESSELS UNDER 20 METERS (65.6 ft.) IN LENGTH

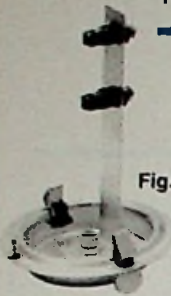

Fig. 290



Fig. 138

### ELECTRIC ADAPTERS FIGS. 138 & 290

Brass Spring Type For Double Ended Bulbs

O.D. Overall Inches	I.D. Light Opening Inches	Height Overall Inches	Standard Pkg.-1 pc.
2 <sup>3</sup> / <sub>16</sub>	1 <sup>7</sup> / <sub>8</sub>	3 <sup>1</sup> / <sub>2</sub>	138 F02
2 <sup>3</sup> / <sub>16</sub>	1 <sup>7</sup> / <sub>8</sub>	3 <sup>3</sup> / <sub>4</sub>	138 F03
4 <sup>1</sup> / <sub>2</sub>	3 <sup>9</sup> / <sub>16</sub>	4 <sup>3</sup> / <sub>4</sub>	290 F02
4 <sup>1</sup> / <sub>2</sub>	3 <sup>9</sup> / <sub>16</sub>	5 <sup>1</sup> / <sub>4</sub>	290 F03

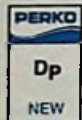

Fig. 52



Fig. 276

### DOUBLE CONTACT BAYONET SOCKETS FIGS. 52 & 276

Brass, with 6 Inch Wire Leads — Fig. 276 Tapped for 1/8 Inch Pipe

Length Overall Inches	Standard Pkg.-5 pcs.	Display Pkg.-10 bags 1 Pc. per bag
1	-----	52 DP
1 <sup>1</sup> / <sub>2</sub>	276 000	
2	276 002	
2 <sup>3</sup> / <sub>8</sub>	276 003	
3	276 004	

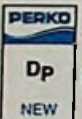

Fig. 24

### DOUBLE CONTACT BAYONET SOCKET FIG. 24

Black Plastic Body — Brass Spring

Length Pigtail Inches	O.D. Inches	Display Pkg.-10 bags 1 Pc. per bag
10	3/4	24 DP1
60	3/4	24 DP2

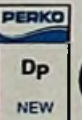

Fig. 1109

### SINGLE CONTACT BAYONET SOCKET FIG. 1109

Brass

Length Pigtail Inches	Length Socket Inches	O.D. Inches	Display Pkg.-10 bags 1 Pc. per bag
6	5/8	3/8	1109 DP



Fig. 286



Fig. 287

### OIL FOUNTS FIGS. 286 & 287

Brass

O.D. Overall Inches	I.D. Light Opening Inches	Standard Pkg.-1 pc.
3 <sup>5</sup> / <sub>8</sub>	3 <sup>3</sup> / <sub>16</sub>	286 000 PLB
4 <sup>1</sup> / <sub>2</sub>	4	287 000 PLB



Fig. 231



Fig. 246

### OIL BURNERS FIGS. 231 & 246

Brass

O.D. Thread inches	Width Wick Inches	Plain Standard Pkg.-5 pcs.	Chrome Plated Standard Pkg.-5 pcs.
1 <sup>3</sup> / <sub>16</sub>	3/8	231 000 PLB	231 000 CHR
1 <sup>3</sup> / <sub>16</sub>	3/8	246 000 PLB	-----



Fig. 230

### LAMP CHIMNEY FIG. 230

Glass

O.D. Base Inches	Height Overall Inches	Standard Pkg.-5 pcs.
1 <sup>1</sup> / <sub>2</sub>	4 <sup>3</sup> / <sub>4</sub>	230 000 CLR

## SPARE PARTS

FOR NAVIGATION LIGHTS ON VESSELS UNDER 20 METERS (65.6 ft.) IN LENGTH

### DOUBLE CONTACT BAYONET BASE BULB FIG. 337

Nominal Voltage	Candle Power	Amps	Standard Pkg.-10 pcs.	Display Pkg.-5 bags, 2 Pcs. per bag	Bulb Diameter Inches	Mfr. Lamp No.
12	6	.58	—————	337 011 DP	3/4	90
12	15	.94	—————	337 012 DP	3/4	1004
12	21	1.44	—————	337 013 DP	1	1142
32	9	.37	337 018 CLR	—————	3/4	624
32	15	.45	337 019 CLR	—————	1	1228
32	21	.61	337 020 CLR	—————	1	1692
32	32	.74	337 021 CLR	—————	1 3/8	1054
120	15W	—	—————	337 023 DP	7/8	15T7



Fig. 337



### DOUBLE CONTACT BAYONET BULB FIG. 374

Nominal Voltage	Wattage	Amps	Standard Pkg.-1 pc.
12	30	2.5	374 001 CLR
24	30	1.25	374 002 CLR
32	30	.94	374 003 CLR
120	30	.25	374 004 CLR



Fig. 374

### DOUBLE CONTACT BAYONET INDEXING BASE BULB FIG. 375

Nominal Voltage	Wattage	Amps	Standard Pkg.-1 pc.
12	10	.83	375 12V 10W
12	25	2.08	375 12V 25W
24	10	.42	375 24V 10W
24	25	1.04	375 24V 25W
32	10	.31	375 32V 10W
32	25	.78	375 32V 25W



Fig. 375

### MEDIUM SCREW BASE BULB FIG. 340

Nominal Voltage	Wattage	Standard Pkg.-6 pcs.	Type	L.C.L. Inches	Mfr. Lamp No.
12	15	340 005 FRD	A-17	2 3/8	15-A
12	25	340 006 FRD	A-19	2 9/16	25-A
12	50	340 007 FRD	A-21	3 7/16	50-A21
32	15	340 011 FRD	A-17	2 3/8	15-A
32	25	*340 012 FRD	A-19	2 9/16	25-A
32	50	*340 013 FRD	A-21	3 7/16	50-A21

\*Std. Pkg.-2 pcs.



Fig. 340



### DOUBLE ENDED-FESTOON BULBS FIGS. 69, 70, 71, & 72

Nominal Voltage	Candle Power	Amps	Display Pkg.-5 bags, 2 Pcs. per bag	Bulb Diameter Inches	Bulb Length Inches
12	8	.83	69 DP CLR	3/8	1 5/8
12	6	.74	70 DP0 CLR	9/16	1 11/16
12	12	.97	70 DP1 CLR	9/16	1 11/16
12	8	.80	71 DP CLR	3/8	1 1/8
24	8	.40	72 DP1 CLR	3/8	1 1/8
32	12	.40	70 DP2 CLR	3/8	1 5/8



Fig. 69  
Fig. 70  
Fig. 71  
Fig. 72

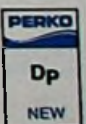

## SPARE PARTS

FOR NAVIGATION LIGHTS ON VESSELS UNDER 20 METERS (65.6 ft.) IN LENGTH

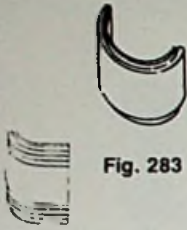

Fig. 268



Fig. 283



Fig. 259



Fig. 296

### 112½° LENSES FOR BI-COLOR/TRI-COLOR LIGHTS

Color	Height Inches	Width Inches	Display Pkg.-5 bags 1 Set per bag
Red/Green	1	1¾	283 DPA LNS
Red/Green	1¼	1⅝	296 DP LNS
Red/Green	2½	2	259 DPA LNS
Red/Green	1½	1	268 DP LNS

### 112½° LENSES FOR SIDE LIGHTS

Color	Height Inches	Width Inches	Display Pkg.-5 bags 1 Set per bag	Std. Pkg.-1 pc.
Red/Green	1	1⅞	281 DPA LNS*	_____
Red/Green	1¼	—	260 DP LNS*	_____
Red	4¼	3⅞	_____	259 CL2 RED
Green	4¼	3⅞	_____	259 CL2 GRN
Red	5⅞	3⅞	_____	259 CL3 RED
Green	5⅞	3⅞	_____	259 CL3 GRN

\*Set of 1 Red and 1 Green Lens.

### 225° LENSES FOR MASTHEAD LIGHTS

Color	Height Inches	I.D. Inches	O.D. Inches	Display Pkg.-5 bags 1 Pc. per bag	Std. Pkg.-1 pc.
White	1	1⅞	2⅞	281 DPA WHT	_____
White	1½	1	1¼	278 DP WHT*	_____
White	4¼	3⅞	—	_____	256 CL2 WHT
White	5⅞	3¼	—	_____	256 CL3 WHT

\*Display Pkg. 5 bags — 2 Pcs. per bag.

### 135° LENSES FOR STERN LIGHTS

Color	Height Inches	I.D. Inches	O.D. Inches	Display Pkg.-5 bags 1 Pc. per bag	Std. Pkg.-1 pc.
White	1¼	1⅞	2⅞	74 000 WHT	_____
White	1½	1	1¼	278 DP WHT*	_____
White	1¼	1⅞	2⅞	281 DPA WHT	_____
Clear	—	—	2	284 DP CLR**	_____
White	4¼	3½	—	_____	269 CL2 WHT
White	5⅞	3⅞	—	_____	269 CL3 WHT
Yellow	4¼	3½	—	_____	269 CL2 YLW
Yellow	5⅞	3⅞	—	_____	269 CL3 YLW

\*Display Pkg. 5 bags — 2 Pcs. per bag.

\*\*Includes Gasket.

### 360° LENSES FOR ALL-ROUND LIGHTS

Color	Height Inches	I.D. Inches	O.D. Inches	Std. Pkg.-1 pc.
Red	5	2⅞	3¼	106 000 RED
Green	5	2⅞	3¼	106 000 GRN
White	5	2⅞	3¼	106 000 WHT
Yellow	5	2⅞	3¼	106 000 YLW
Gray	5	2⅞	3¼	106 000 GRY
White	3	1½	1⅞	201 DP WHT*
Clear	2½	1⅞	2	248 DP CLR*
Frosted	2½	1⅞	2	248 000 FRD
Clear	3⅞	3⅞	—	261 JR0 CLR
Frosted	3⅞	3⅞	—	261 JR0 FRD
Clear	4¼	4	—	261 SR0 CLR
Frosted	4¼	4	—	261 SR0 FRD

\*Display Pkg. 5 bags — 1 Pc. per bag.

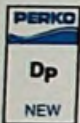

Fig. 281



Fig. 260

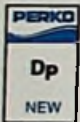

Fig. 278



Fig. 256



Fig. 74



Fig. 269

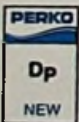

Fig. 284



Fig. 201



Fig. 248



Fig. 261



Fig. 106



Fig. 248F



## U.S. COAST GUARD REGULATIONS FOR NAVIGATION LIGHTS ON VESSELS OVER 20 METERS (65.6 ft.) IN LENGTH

On March 31, 1977, the U.S. Coast Guard published in the Federal Register, an amendment to the navigation and navigable water regulations, which added a new subchapter DD, (33CFR 87). This subchapter contains rules implementing and interpreting the International Regulations for Preventing Collisions at Sea, 1972 (72 COLREGS). The International Regulations for Preventing Collisions at Sea, 1960, were replaced by the 72 COLREGS at 1200 hours, zone time on July 15, 1977. Therefore, all vessels on the high seas must comply with the 72 COLREGS at this time. In addition, with the enactment of the U.S. Inland Navigation Rules Act of 1980, the Inland Rules, Western Rules, and Great Lakes Rules were unified into a single set of requirements. The effective date for this legislation was December 24, 1981 (March 1, 1983 for Great Lakes). Therefore, all vessels must comply with these rules at this time.

Rules 21 and 22 of the 72 COLREGS and the U.S. Inland Navigation Rules give the color and range requirements for various navigation lights. Annex 1 to the 72 COLREGS and the U.S. Inland Navigation Rules gives positioning and technical details for these lights.

### U.S. COAST GUARD ACCEPTANCE OF NAVIGATION LIGHTS

All U.S. Registered vessels are subject to either the 72 COLREGS or the U.S. Inland Rules. The U.S. Coast Guard is accepting lights that have passed the U.L. tests (U.L. Standard 1104) as meeting the 72 COLREGS and the U.S. Inland Rules for vessels over 20 meters (65.6 ft.) in length. U.S. requirements for smaller vessels are less strict. As the first domestic manufacturer to pass U.L. 1104, PERKO's lights can be installed on vessels over 20 meters (65.6 ft.) in length. Some models are designed for use on vessels over 20 meters (65.6 ft.) in length, while others are designed for use on vessels 20 meters (65.6 ft.) to 50 meters (164.0 ft.) in length.

A brass tag is permanently affixed to the light indicating the type of light, figure no., voltage and bulb type to install to meet the visibility requirements. It also states that the light is classified by U.L. in accordance with the 72 COLREGS. This is the only documentation needed by a vessel for navigation lights to certify light construction compliance with the 72 COLREGS and the Inland Navigation Rules, and eliminates the former "Certificate of Compliance".

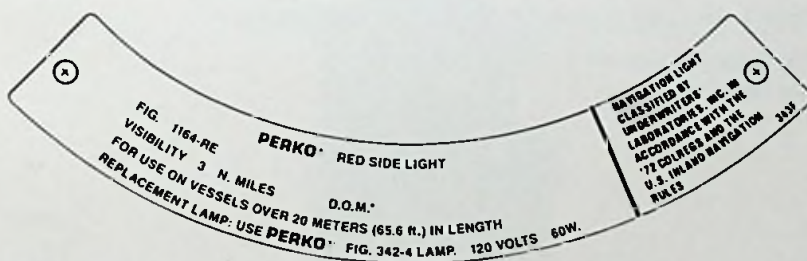

\*Each light has its own serial no. for identification.

The lights indicated for use on vessels over 20 meters (65.6 ft.) in length have passed U.L. 1104. The facsimile of the tag shown above is used on our cast bronze lights. Similar rectangular tags are used on other style lights.

Please note that any changes made to PERKO Navigation lights, including substitution of bulbs other than those shown in our catalog, instruction sheets, or metal tags (affixed to some lights) will void all certifications and U.S. Coast Guard acceptance.

For the present, the U.S. Coast Guard will not publish a list of U.L. classified lights. However, field offices have been notified. For more detailed information, consult the complete 72 COLREGS, the U.S. Inland Navigation Rules, and your local U.S. Coast Guard office.

### SPECIAL PURPOSE LIGHTS

Other lights (not shown) for use where the vessel is subject to special local requirements are available. Contact PERKO for further information.

## SINGLE LENS NAVIGATION LIGHTS

FOR USE ON VESSELS OVER 20 METERS (65.6 FT.) IN LENGTH

### CAST BRONZE

Complete with a Pre-Wired Medium Prefocus Socket and  
3 Feet of 16/3-SO Cable through a watertight terminal tube.  
Watertight access cap for rebulbing and cleaning.  
120 Volt Bulb Included.

Height Overall Inches	Height Lens Inches	Weight Pounds	Mounting Bolt Size Inches
9¼	6¾	11½	¾

### ORDERING INFORMATION

Description	Visibility Arc	Visibility Miles	Cat. No.
Red Side Light	112½°	3	1172 REO PLB
Green Side Light	112½°	3	1172 GEO PLB
White Masthead Light	225°	6	1173 EOO PLB
White Stern Light*	135°	3	1174 EOO PLB
Yellow Towing Light	135°	3	1174 MEO PLB
White All-Round Light*	360°	3	1169 EOO PLB
White All-Round Light**	360°	6	1169 HEO PLB
Red All-Round Light	360°	3	1170 REO PLB
Green All-Round Light	360°	3	1170 GEO PLB
Yellow All-Round Light	360°	3	1170 MEO PLB

*Special lights to meet local requirements are available upon request.*

\*These lights are supplied with a Gray Tinted Lens.

\*\*For Great Lakes use.



### IMPORTANT BULB DATA

To comply with U.L. Standard 1104, the lights listed on this page must use a PERKO Cat. No. 342 004 CLR bulb.

### SPARE PARTS ORDERING INFORMATION

#### Spare Lenses:

Red, Cat. No. 261 001 RED  
Green, Cat. No. 261 001 GRN  
White, Cat. No. 261 001 CLR  
Gray, Cat. No. 261 001 GRY  
Yellow, Cat. No. 261 001 YLW

Spare Lens Gasket, Cat. No. 1143.  
Spare O-Ring for Cap, Cat. No. 1119.  
Spare Medium Prefocus Socket, Cat. No. 347.  
Spare Lens Retaining Clip with Bolt, Cat. No. 1133.  
Spare Access Cap, O-Ring and Retainer, Cat. No. 1105 000 BLK.

## DOUBLE LENS NAVIGATION LIGHTS

FOR USE ON VESSELS OVER 20 METERS (65.6 FT.) IN LENGTH

### CAST BRONZE

Each compartment contains a Pre-Wired Medium Prefocus Bulb Socket with 3 Feet of 16/3-SO Cable through a watertight terminal tube. Watertight access cap for rebulbing and cleaning. 120 Volt Bulbs Included.

Height Overall Inches	Height Lens Inches	Weight Pounds	Mounting Bolt Size Inches
17¼	6¾	22½	¾

### ORDERING INFORMATION

Description	Visibility Arc	Visibility Miles	Cat. No.
Red Side Light	112½°	3	1164 REO PLB
Green Side Light	112½°	3	1164 GEO PLB
White Masthead Light	225°	6	1165 EOO PLB
White Stern Light*	135°	3	1166 EOO PLB
Yellow Towing Light	135°	3	1166 MEO PLB
White All-Round Light*	360°	3	1167 EOO PLB
White All-Round Light**	360°	6	1167 HEO PLB
Red All-Round Light	360°	3	1168 REO PLB
Green All-Round Light	360°	3	1168 GEO PLB
Yellow All-Round Light	360°	3	1168 MEO PLB

*Special lights to meet local requirements are available upon request.*

\*These lights are supplied with a Gray Tinted Lens.

\*\*For Great Lakes use.



### IMPORTANT BULB DATA

To comply with U.L. Standard 1104, the lights listed on this page must use PERKO Cat. No. 342 004 CLR bulbs.

### SPARE PARTS ORDERING INFORMATION

#### Spare Lenses:

Red, Cat. No. 261 001 RED  
 Green, Cat. No. 261 001 GRN  
 White, Cat. No. 261 001 CLR  
 Gray, Cat. No. 261 001 GRY  
 Yellow, Cat. No. 261 001 YLW

Spare O-Ring for Cap, Cat. No. 1119.  
 Spare Lens Gasket, Cat. No. 1143.  
 Spare Lens Retaining Clip with Bolt, Cat. No. 1133.  
 Spare Dual Medium Prefocus Socket Assembly, Cat. No. 303.  
 Spare Plastic Cap, O-Ring and Retainer, Cat. No. 1105 000 BLK.

## NAVIGATION LIGHTS

FOR USE ON VESSEL LENGTHS AS SPECIFIED BELOW

**Sheet metal; Galvanized Steel\*, Plain or Polished Brass.  
Complete with a Medium Prefocus Socket and a  
watertight terminal tube for 16/3-SO cable.  
Watertight access cap for rebulbing and cleaning.  
120 Volt Bulb Not Included.**

Size No.	Height Overall Inches	Height Lens Inches	Weight Pounds
1	11½	6¾	6⅝
2	13½	7½	10⅞

**ORDERING INFORMATION** For Use On Vessels 20 Meters (65.6 ft.) to 50 Meters (164.0 ft.) In Length

Description	Galv. Steel*	Plain Brass	Polished Brass	Visibility Arc	Visibility Miles	Required Bulb
Red Side Light	1150 RE1 GAL	1150 RE1 PLB	1150 RE1 POL	112½°	2	342 002 CLR
Green Side Light	1150 GE1 GAL	1150 GE1 PLB	1150 GE1 POL	112½°	2	342 002 CLR
White Masthead Light	1151 EO1 GAL	1151 EO1 PLB	1151 EO1 POL	225°	5	342 003 CLR
White Stern Light	1152 EO1 GAL	1152 EO1 PLB	1152 EO1 POL	135°	2	342 000 CLR
Yellow Towing Light	1152 ME1 GAL	1152 ME1 PLB	1152 ME1 POL	135°	2	342 000 CLR
White All-Round Light	1153 EO1 GAL	1153 EO1 PLB	1153 EO1 POL	360°	2	342 001 CLR
Red All-Round Light	1154 RE1 GAL	1154 RE1 PLB	1154 RE1 POL	360°	2	342 004 CLR
Green All-Round Light	1154 GE1 GAL	1154 GE1 PLB	1154 GE1 POL	360°	2	342 003 CLR
Yellow All-Round Light	1154 ME1 GAL	1154 ME1 PLB	1154 ME1 POL	360°	2	342 002 CLR

**ORDERING INFORMATION** For Use On Vessels Over 20 Meters (65.6 ft.) In Length.

Description	Galv. Steel*	Plain Brass	Polished Brass	Visibility Arc	Visibility Miles	Required Bulb
Red Side Light	1150 RE2 GAL	1150 RE2 PLB	1150 RE2 POL	112½°	3	342 004 CLR
Green Side Light	1150 GE2 GAL	1150 GE2 PLB	1150 GE2 POL	112½°	3	342 004 CLR
White Masthead Light	1151 EO2 GAL	1151 EO2 PLB	1151 EO2 POL	225°	6	342 004 CLR
White Stern Light	1152 EO2 GAL	1152 EO2 PLB	1152 EO2 POL	135°	3	342 002 CLR
Yellow Towing Light	1152 ME2 GAL	1152 ME2 PLB	1152 ME2 POL	135°	3	342 002 CLR
White All-Round Light	1153 EO2 GAL	1153 EO2 PLB	1153 EO2 POL	360°	3	342 003 CLR
Red All-Round Light	1154 RE2 GAL	1154 RE2 PLB	1154 RE2 POL	360°	3	342 006 CLR
Green All-Round Light	1154 GE2 GAL	1154 GE2 PLB	1154 GE2 POL	360°	3	342 004 CLR
Yellow All-Round Light	1154 ME2 GAL	1154 ME2 PLB	1154 ME2 POL	360°	3	342 003 CLR

\*Galvanized Steel Lights are Preprimed.



Figs. 1153 & 1154



Fig. 1151



Fig. 1150



Fig. 1152

### IMPORTANT BULB DATA

To comply with U.L. Standard 1104, the lights listed on this page must use a PERKO Fig. No. 342 bulb.

### Spare Lenses:

112½°	Cat. No. 259 No. 1 or 2, Specify Color
135°	Cat. No. 269 No. 1 or 2, Specify Color
225°	Cat. No. 256 No. 1 or 2, Specify Color
360°	Cat. No. 261F No. 1 or 2, Specify Color

### SPARE PARTS ORDERING INFORMATION

Spare Medium Prefocus Socket, Cat. No. 347 A00.  
Spare Access Cap, O-Ring and Retainer, Cat. No. 1105 000 BLK.  
Spare O-Ring for Cap, Cat. No. 1119.



## NAVIGATION LIGHTS

FOR USE ON VESSELS 20 METERS (65.6 FT.) TO 50 METERS (164.0 FT.) IN LENGTH

### BLACK PLASTIC

Complete with Pre-Wired Double Contact Socket and  
3 Feet of 16/3-SJO Cable For 12, 24, 32 or 120 Volts.  
Watertight access cap for rebulbing and cleaning.  
Bulb Not Included.

Height Overall Inches	Height Lens Inches	Screw Size	Weight Pounds
7½	4½	¼	3½

### ORDERING INFORMATION

Description	Visibility Arc	Visibility Miles	Cat. No.
Red Side Light	112½°	2	1127 RAO BLK
Green Side Light	112½°	2	1127 GAO BLK
White Masthead Light	225°	5	1128 AOO BLK
White Stern Light*	135°	2	1129 AOO BLK
Yellow Towing Light	135°	2	1129 MAO BLK
White All-Round Light*	360°	2	1130 AOO BLK
White All-Round Light**	360°	5	1130 HAO BLK
Red All-Round Light	360°	2	1130 RAO BLK
Green All-Round Light	360°	2	1130 GAO BLK
Yellow All-Round Light	360°	2	1130 MAO BLK



All-Round  
Lights  
360 Degrees

\*These lights are supplied with a Gray Tinted Lens.

\*\*For Great Lakes use.



Stern or  
Towing Lights  
135 Degrees



Masthead Lights  
225 Degrees



Red & Green  
Side Lights  
112½ Degrees

### IMPORTANT BULB DATA

To comply with U.L. Standard 1104, the lights listed on this page must use a PERKO Fig. No. 374 bulb.

### SPARE PARTS ORDERING INFORMATION

#### Spare Lens Assemblies:

Red, Cat. No. 249 000 RED.  
Green, Cat. No. 249 000 GRN.  
White, Cat. No. 249 000 CLR.  
Gray, Cat. No. 249 000 GRY.  
Yellow, Cat. No. 249 000 YLW.

Spare Double Contact Socket, Cat. No. 134.  
Spare Access Cap, O-Ring and  
Retainer, Cat. No. 1105 000 BLK.  
Spare O-Ring for Cap, Cat. No. 1119.

#### Required Bulbs:

12 Volts, Cat. No. 374 001 CLR.  
24 Volts, Cat. No. 374 002 CLR.  
32 Volts, Cat. No. 374 003 CLR.  
120 Volts, Cat. No. 374 004 CLR.

## NAVIGATION LIGHTS

FOR USE ON VESSELS 20 METERS (65.6 FT.) TO 50 METERS (164.0 FT.) IN LENGTH

Sheet metal; Galvanized Steel\*, Polished or Chrome Plated Brass.  
Bottom Opening, Complete with Mounting Bracket  
and Single Contact Prefocus Socket for  
12 Volt Use Only. Bulb Not Included.

Height Overall Inches	Height Lens Inches	Weight Pounds
8½	5⅞	2½

### ORDERING INFORMATION

Description	Galvanized Steel*	Polished Brass	Chrome Plated Brass	Visibility Arc	Visibility Miles	Required Bulb
Red Side Light	4 RD3 GAL	4 RD3 POL	4 RD3 CHR	112½°	2	373 003 CLR
Green Side Light	4 GD3 GAL	4 GD3 POL	4 GD3 CHR	112½°	2	373 002 CLR
White Masthead Light	5 DO3 GAL	5 DO3 POL	5 DO3 CHR	225°	5	373 005 CLR
White Stern Light	7 DO3 GAL	7 DO3 POL	7 DO3 CHR	135°	2	373 001 CLR
Yellow Towing Light	7 MD3 GAL	7 MD3 POL	7 MD3 CHR	135°	2	373 002 CLR

\*Galvanized Steel Lights are Preprimed.



Figs. 7 & 7M



Fig. 4



Fig. 5



### IMPORTANT BULB DATA

To comply with U.L. Standard 1104, the lights listed on this page must use a PERKO Fig. No. 373 bulb.

### SPARE PARTS ORDERING INFORMATION

#### Spare Lenses:

Red	112½°	Cat. No. 259 CL3 RED.
Green	112½°	Cat. No. 259 CL3 GRN.
White	135°	Cat. No. 269 CL3 WHT.
Yellow	135°	Cat. No. 269 CL3 YLW.
White	225°	Cat. No. 258 CL3 WHT.

Spare Mounting Bracket; Cat. No. 131 000, GAL or PLB.  
Spare Single Contact Prefocus Socket Assembly, Complete  
with Stand, Bottom Plate and Gasket, Cat. No. 294 003 PLB.

## ALL-ROUND LIGHTS

FOR USE ON VESSELS OVER 20 METERS (65.6 FT.) IN LENGTH

### CAST BRONZE

Complete with Medium Prefocus Socket and 120 Volt Bulb.

Fig. No.	Height Overall Inches	Height Lens Inches	Tapped Pipe Size Inches	Weight Pounds	Visibility Miles
403	11½	6¾	1	8¼	3
412	14	6¾	•	8¼	3



Fig. 403-3

### ORDERING INFORMATION

	White	Red	Green	Yellow
Fig. No. 403	403 EO3 PLB**	403 RE3 PLB	403 GE3 PLB	403 ME3 PLB
Fig. No. 412	412 EOO PLB**	412 REO PLB	412 GEO PLB	412 MEO PLB

\*Supplied with watertight terminal tube for 16/3-SO cable.

\*\*These Lights are Supplied with Gray Tinted Lenses.

### IMPORTANT BULB DATA

To comply with U.L. Standard 1104, the lights above must use a PERKO Cat. No. 342 004 CLR bulb.

### SPARE PARTS ORDERING INFORMATION

#### Spare Lenses:

Gray, Cat. No. 261 001 GRY.  
Red, Cat. No. 261 001 RED.  
Green, Cat. No. 261 001 GRN.  
Yellow, Cat. No. 261 001 YLW.

Spare Lens or Cover Gasket, Cat. No. 1143.  
Spare Medium Prefocus Socket, Cat. No. 347.



Fig. 412

## ALL-ROUND LIGHTS

FOR USE ON VESSELS 20 METERS (65.6 FT.) TO 50 METERS (164.0 FT.) IN LENGTH

### CAST BRONZE

Plain or Chrome Plated. Complete with Double Contact Electrical Socket for 12, 24, 32 or 120 Volts. Bulb Not Included.

Fig. No.	Height Overall Inches	Diameter Base Inches	Tapped Pipe Size Inches	Weight Pounds	Visibility Miles
112	8¾	3½	—	2½	2
309	6½	—	½	2¼	2

### ORDERING INFORMATION

Description	Plain Bronze	Chrome Plated Bronze
White All-Round	112 AOO PLB	112 AOO CHR
Red All-Round	112 RAO PLB	112 RAO CHR
Green All-Round	112 GAO PLB	112 GAO CHR
Yellow All-Round	112 MAO PLB	112 MAO CHR

### ORDERING INFORMATION

Description	Plain Bronze	Chrome Plated Bronze
White All-Round	309 AOO PLB	309 AOO CHR
Red All-Round	309 RAO PLB	309 RAO CHR
Green All-Round	309 GAO PLB	309 GAO CHR
Yellow All-Round	309 MAO PLB	309 MAO CHR

### IMPORTANT BULB DATA

To comply with U.L. Standard 1104, the lights listed above must use a PERKO Fig. No. 374 bulb.

### SPARE PARTS ORDERING INFORMATION

#### Spare Globes:

Red, Cat. No. 106 000 RED.  
Green, Cat. No. 106 000 GRN.  
White, Cat. No. 106 000 WHT.  
Yellow, Cat. No. 106 000 YLW.  
Spare Double Contact Bayonet Socket, Cat. No. 276 002.

#### Required Bulbs:

12 Volts, Cat. No. 374 001 CLR.  
24 Volts, Cat. No. 374 002 CLR.  
32 Volts, Cat. No. 374 003 CLR.  
120 Volts, Cat. No. 374 004 CLR.



Fig. 112A



Fig. 309A

## SPECIAL FLASHING YELLOW BARGE LIGHT FIG. 1111ME FOR USE ON VESSELS OF ANY LENGTH

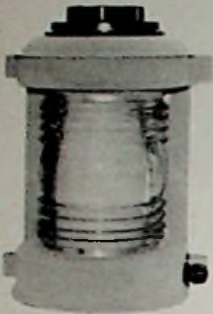

Fig. 1111ME

Sheet metal; Galvanized Steel\* or Plain Brass. Complete with Medium Prefocus Socket and watertight terminal tube for 16/3-SO cable. Sealed Flasher Unit, Watertight access cap for rebulbing and cleaning. 120 Volt Bulb Not Included.

Designed to meet Federal Requirements for flashing yellow 180°-225° light for barges, canal boats, etc., that are being pushed ahead or towed along side of a tug boat. For use on 120 volts A.C. only. Federal Requirements for this light are applicable for: inland waters, the Atlantic, Pacific and Gulf coasts, intercoastal waterways and western rivers. Refer to the U.S. Inland Navigation Rules for application, configuration and technical details.

### ORDERING INFORMATION

Galvanized Steel*	Plain Brass	Height Overall Inches	Height Lens Inches	Visibility Miles	Visibility Arc	Flashes Per Minute	Weight Pounds
1111 ME1 GAL	1111 ME1 PLB	11½	6¾	2	225°	50-70	6½

\*Galvanized Steel Lights are Preprimed.

### IMPORTANT BULB DATA

To comply with Federal Requirements this light must use a PERKO Cat. No. 342 004 CLR bulb.

### SPARE PARTS ORDERING INFORMATION

Spare Flasher, Cat. No. 133.	Spare Medium Prefocus Socket, Cat. No. 347 A00.
Spare O-Ring for Cap, Cat. No. 1119.	Spare Access Cap, O-Ring and Retainer, Cat. No. 1105 000 BLK.
Spare Lens, Cat. No. 256 001 YLW.	

## PANAMA CANAL BLUE STEERING LIGHT FIG. 1129BA FOR USE ON VESSELS OF ANY LENGTH



Fig. 1129BA

Black Plastic, Pre-Wired Double Contact Socket with 3 Feet of 16/3-SJO Cable. For 12, 24, 32 or 120 Volts, Bulb Not Included.

### ORDERING INFORMATION

Cat. No.	Visibility Arc	Height Overall Inches	Height Lens Inches	Weight Pounds
1129 BAO BLK	135°	7½	4½	3½

### IMPORTANT BULB DATA

To comply with Panama Canal Requirements, the light above must use a PERKO Fig. No. 374 bulb.

### SPARE PARTS ORDERING INFORMATION

<b>Required Bulbs:</b>	Spare Lens, Cat. No. 249 000 BLU.
12 Volts, Cat. No. 374 001 CLR.	Spare O-Ring for Cap, Cat. No. 1119.
24 Volts, Cat. No. 374 002 CLR.	Spare Double Contact Socket, Cat. No. 134.
32 Volts, Cat. No. 374 003 CLR.	Spare Plastic Cap, O-Ring and Retainer, Cat. No. 1105 000 BLK.
120 Volts, Cat. No. 374 004 CLR.	

## ALL-ROUND WHITE WHISTLE LIGHT FIG. 454E FOR USE ON VESSELS OVER 20 METERS (65.6 FT.) IN LENGTH



Fig. 454E



**CAST BRONZE**  
Complete with Medium Prefocus Socket and 120 Volt Bulb.

### ORDERING INFORMATION

Cat. No.	Height Overall In.	Height Lens In.	Tapped Pipe Size In.	Weight Pounds	Visibility Miles
454 E00 PLB	11½	6¾	1	8¼	5

### SPARE PARTS ORDERING INFORMATION

Spare Bulb, Cat. No. 342 004 CLR.	Spare Lens or Cover Gasket, Cat. No. 1143.
Spare Lens, Cat. No. 261 001 CLR.	Spare Medium Prefocus Socket, Cat. No. 347.

## EMERGENCY OIL NAVIGATION LIGHTS

FOR USE ON VESSEL LENGTHS AS SPECIFIED BELOW

**Sheet metal; Galvanized Steel, Plain or Polished Brass,  
Bottom Opening, Complete with Mounting Bracket, Turret Top  
and Oil Lamp in Base of Light.**

Size No.	Height Overall Inches	Height Lens Inches	Weight Pounds
1	15	6¾	7
2	18	7½	10½

### ORDERING INFORMATION

For Use On Vessels 20 Meters (65.6 ft.) To 50 Meters (164.0 ft.) In Length.

Description	Galvanized Steel	Plain Brass	Polished Brass	Visibility Arc
Red Side Light	21 RO1 GAL	21 RO1 PLB	21 RO1 POL	112½°
Green Side Light	21 GO1 GAL	21 GO1 PLB	21 GO1 POL	112½°
White Masthead Light	982 OO1 GAL	982 OO1 PLB	982 OO1 POL	225°
Red Masthead Light	982 RO1 GAL	982 RO1 PLB	982 RO1 POL	225°
White Masthead Light	982 MO1 GAL	982 MO1 PLB	982 MO1 POL	225°
White Stern Light	985 OO1 GAL	985 OO1 PLB	985 OO1 POL	135°
Red Stern Light	985 RO1 GAL	985 RO1 PLB	985 RO1 POL	135°
Yellow Stern Light	985 MO1 GAL	985 MO1 PLB	985 MO1 POL	135°
White All-Round Light	23 OO1 GAL	23 OO1 PLB	23 OO1 POL	360°
Red All-Round Light	129 RO1 GAL	129 RO1 PLB	129 RO1 POL	360°
Green All-Round Light	129 GO1 GAL	129 GO1 PLB	129 GO1 POL	360°
Yellow All-Round Light	129 MO1 GAL	129 MO1 PLB	129 MO1 POL	360°



Fig. 21



Fig. 982

### ORDERING INFORMATION

For Use On Vessels Over 20 Meters (65.6 ft.) In Length.

Description	Galvanized Steel	Plain Brass	Polished Brass	Visibility Arc
Red Side Light	21 RO2 GAL	21 RO2 PLB	21 RO2 POL	112½°
Green Side Light	21 GO2 GAL	21 GO2 PLB	21 GO2 POL	112½°
White Masthead Light	982 OO2 GAL	982 OO2 PLB	982 OO2 POL	225°
Red Masthead Light	982 RO2 GAL	982 RO2 PLB	982 RO2 POL	225°
Yellow Masthead Light	982 MO2 GAL	982 MO2 PLB	982 MO2 POL	225°
White Stern Light	985 OO2 GAL	985 OO2 PLB	985 OO2 POL	135°
Red Stern Light	985 RO2 GAL	985 RO2 PLB	985 RO2 POL	135°
Yellow Stern Light	985 MO2 GAL	985 MO2 PLB	985 MO2 POL	135°
White All-Round Light	23 OO2 GAL	23 OO2 PLB	23 OO2 POL	360°
Red All-Round Light	129 RO2 GAL	129 RO2 PLB	129 RO2 POL	360°
Green All-Round Light	129 GO2 GAL	129 GO2 PLB	129 GO2 POL	360°
Yellow All-Round Light	129 MO2 GAL	129 MO2 PLB	129 MO2 POL	360°



Fig. 985



Figs. 23 & 129

### SPARE PARTS ORDERING INFORMATION

#### Spare Lenses:

112½°	Cat. No. 259 No. 1 or 2, Specify Color
135°	Cat. No. 269 No. 1 or 2, Specify Color
225°	Cat. No. 256 No. 1 or 2, Specify Color
360°	Cat. No. 261 No. 1 or 2, Specify Color
Spare Mounting Bracket, Cat. No. 143 000 ALU.	

Spare Burner, Cat. No. 242 000 PLB.
Spare Wick, Cat. No. 302 002.
Spare Chimney, Cat. No. 267 000 CLR.
Spare Oil Fount Size 1, Cat. No. 282 001 PLB.
Spare Oil Fount Size 2, Cat. No. 282 002 PLB.

## SPARE PARTS

FOR NAVIGATION LIGHTS ON VESSELS OVER 20 METERS (65.6 ft.) IN LENGTH

### DUAL MEDIUM PREFOCUS SOCKET ASSEMBLY

Phenolic — 250 Volts — 1000 Watts



Plug in Type — Prewired — with two medium prefocus sockets. For use in double lens lights.

Cat. No.	Height Overall Inches	Width Overall Inches	Weight Ounces
303	3 <sup>7</sup> / <sub>8</sub>	3 <sup>7</sup> / <sub>8</sub>	9

Male Plug Only Cat. No 303 A00. Female Plug Only Cat. No. 303 B00

### 112½° LENSES



	Height Overall Inches	Dia. Opening Inches	Cat. No.
Red	6 <sup>3</sup> / <sub>4</sub>	6 <sup>1</sup> / <sub>8</sub>	259 001 RED
Green	6 <sup>3</sup> / <sub>4</sub>	6 <sup>1</sup> / <sub>8</sub>	259 001 GRN
Red	7 <sup>1</sup> / <sub>2</sub>	9 <sup>1</sup> / <sub>4</sub>	259 002 RED
Green	7 <sup>1</sup> / <sub>2</sub>	9 <sup>1</sup> / <sub>4</sub>	259 002 GRN

Weight Size 1, 8.5 oz. Weight Size 2, 19.5 oz.

### MEDIUM PREFOCUS SOCKETS

Phenolic — 250 Volts — 1000 Watts



Cat. No.	Height Overall Inches	Dia. Overall Inches	Standard Package	Weight Per Pkg. Ounces
347	1 <sup>7</sup> / <sub>8</sub>	1 <sup>1</sup> / <sub>2</sub>	5	21 <sup>1</sup> / <sub>2</sub>
347 A00	1 <sup>7</sup> / <sub>8</sub>	1 <sup>1</sup> / <sub>2</sub>	5	21 <sup>1</sup> / <sub>2</sub>

Cat. No. 347 A00 supplied with metal Mounting Cap Tapped for 3/8" I.P.S.

### 135° LENSES



	Height Overall Inches	Dia. Opening Inches	Cat. No.
White	6 <sup>3</sup> / <sub>4</sub>	5 <sup>1</sup> / <sub>8</sub>	269 001 WHT
Red	6 <sup>3</sup> / <sub>4</sub>	5 <sup>1</sup> / <sub>8</sub>	269 001 RED
Yellow	6 <sup>3</sup> / <sub>4</sub>	5 <sup>1</sup> / <sub>8</sub>	269 001 YLW
White	7 <sup>1</sup> / <sub>2</sub>	7 <sup>1</sup> / <sub>4</sub>	269 002 WHT
Red	7 <sup>1</sup> / <sub>2</sub>	7 <sup>1</sup> / <sub>4</sub>	269 002 RED
Yellow	7 <sup>1</sup> / <sub>2</sub>	7 <sup>1</sup> / <sub>4</sub>	269 002 YLW

Weight Size 1, 14 oz. Weight Size 2, 18.5 oz.

### DOUBLE CONTACT BAYONET BULBS

Clear — 12, 24, 32 or 120 Volts,  
Type T-8, C-8, Filament — 1<sup>3</sup>/<sub>8</sub>" L.C.L.



Cat. No.	Voltage	Wattage	Candella
374 001 CLR	12	30	24
374 002 CLR	24	30	24
374 003 CLR	32	30	24
374 004 CLR	120	30	24

Weight 1 oz.

Standard Pkg.-1pc.

### 225° LENSES



	Height Overall Inches	Dia. Opening Inches	Cat. No.
White	6 <sup>3</sup> / <sub>4</sub>	4 <sup>1</sup> / <sub>2</sub>	256 001 WHT
Red	6 <sup>3</sup> / <sub>4</sub>	4 <sup>1</sup> / <sub>2</sub>	256 001 RED
Yellow	6 <sup>3</sup> / <sub>4</sub>	4 <sup>1</sup> / <sub>2</sub>	256 001 YLW
White	7 <sup>1</sup> / <sub>2</sub>	6 <sup>5</sup> / <sub>8</sub>	256 002 WHT
Red	7 <sup>1</sup> / <sub>2</sub>	6 <sup>5</sup> / <sub>8</sub>	256 002 RED
Yellow	7 <sup>1</sup> / <sub>2</sub>	6 <sup>5</sup> / <sub>8</sub>	256 002 YLW

Weight Size 1, 18.5 oz. Weight Size 2, 27.5 oz.

### MEDIUM PREFOCUS BULBS

Clear — 120 Volts

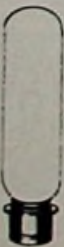

Cat. No.	Wattage
342 000 CLR	7.5
342 001 CLR**	15
342 002 CLR**	25
342 003 CLR**	40
342 004 CLR**	60
342 RS4 CLR*	60
342 006 CLR	125

Weight 1 oz.

\*Designed for rough service.

Standard Pkg.-1pc. \*\*OEM Pkg.-25 pcs.

### 360° LENSES



	Height Overall Inches	Dia. Opening Inches	Clear Cat. No.	Frosted Cat. No.
White	6 <sup>3</sup> / <sub>4</sub>	5 <sup>1</sup> / <sub>8</sub>	261 001 CLR	261 001 FRD
Red	6 <sup>3</sup> / <sub>4</sub>	5 <sup>1</sup> / <sub>8</sub>	261 001 RED	261 RF1 RED
Green	6 <sup>3</sup> / <sub>4</sub>	5 <sup>1</sup> / <sub>8</sub>	261 001 GRN	261 GF1 GRN
Yellow	6 <sup>3</sup> / <sub>4</sub>	5 <sup>1</sup> / <sub>8</sub>	261 001 YLW	261 MF1 YLW
Gray	6 <sup>3</sup> / <sub>4</sub>	5 <sup>1</sup> / <sub>8</sub>	261 001 GRY	—
White	7 <sup>1</sup> / <sub>2</sub>	7 <sup>3</sup> / <sub>8</sub>	261 002 CLR	261 002 FRD
Red	7 <sup>1</sup> / <sub>2</sub>	7 <sup>3</sup> / <sub>8</sub>	261 002 RED	261 RF2 RED
Green	7 <sup>1</sup> / <sub>2</sub>	7 <sup>3</sup> / <sub>8</sub>	261 002 GRN	261 GF2 GRN
Yellow	7 <sup>1</sup> / <sub>2</sub>	7 <sup>3</sup> / <sub>8</sub>	261 002 YLW	261 MF2 YLW

Weight Size 1, 13.5 oz. Weight Size 2, 43 oz.

### SINGLE CONTACT PREFOCUS BULBS

C-8 Filament Clear — 12 Volts



Cat. No.	Amperage	Mfg. No.
373 001 CLR	.25	25A/S8
373 002 CLR	.55	55A/S8
373 003 CLR	.77	77A/S8
373 004 CLR	1.15	1.15A/S8
373 005 CLR	2.03	2.03A/S8SCP

Weight 1 oz.

Standard Pkg.-1pc.

### 360° LENSES

With Top Assembly



	Height Overall Inches	Dia. Overall Inches	Cat. No.
White	5 <sup>3</sup> / <sub>4</sub>	5 <sup>1</sup> / <sub>2</sub>	249 000 CLR
Red	5 <sup>3</sup> / <sub>4</sub>	5 <sup>1</sup> / <sub>2</sub>	249 000 RED
Green	5 <sup>3</sup> / <sub>4</sub>	5 <sup>1</sup> / <sub>2</sub>	249 000 GRN
Yellow	5 <sup>3</sup> / <sub>4</sub>	5 <sup>1</sup> / <sub>2</sub>	249 000 YLW
Gray	5 <sup>3</sup> / <sub>4</sub>	5 <sup>1</sup> / <sub>2</sub>	249 000 GRY

Weight 17 oz.

## DECK CONTROL SEARCHLIGHT FIG. 538

Chrome Plated Brass

12 Volt, 4½ Inch Sealed Beam Bulb,  
Tungsten or Halogen

Switch In Head



Fig. 538

### ORDERING INFORMATION

Bulb Type	Approx. Range Miles	Beam Candlepower	Wattage	Height Overall Inches	Catalog Number	Weight Pounds
Tungsten	¼	50,000	30	7½	538 000 CHR	1½
Halogen	⅓	100,000	50	7½	538 H00 CHR	1½

Base Diameter, 3½ Inches.

Spare 4½" Sealed Beam Unit, Cat. No. 433 001 12V.

Spare 4½" Halogen Sealed Beam Unit, Cat. No. 435 001 12V.

## REMOVABLE DECK CONTROL SEARCHLIGHT FIG. 440

Chrome Plated Brass Head with  
Chrome Plated Zinc Base

For 12 or 32 Volts, 4½ or 7 Inch Sealed Beam Bulb

Complete with 8 Feet of Coiled Cord, Cigarette Lighter Plug  
and Watertight Deck Connection.

Switch In Head



Fig. 440 003

### ORDERING INFORMATION

Voltage	O.D. Bulb Inches	Approx. Range Miles	Beam Candlepower	Wattage	Catalog Number	Weight Pounds
12	4½	¼	50,000	30	440 001 12V	2¼
12	4½	⅓	100,000	50	440 H01 12V*	2¼
12	7	⅝	250,000	100	440 003 12V	3½
32	7	⅝	260,000	200	440 003 32V	3½

Base Diameter, 2⅞ Inches.

Height Overall, No. 1 — 7½ In., No. 3 — 10 In.

\*NOTE: "H" in Catalog Number Designates a Halogen Bulb.

Spare 4½" Sealed Beam Unit, Cat. No. 433 001 12V.

Spare 4½" Halogen Sealed Beam Unit, Cat. No. 435 001 12V.

Spare 7" Sealed Beam Unit (12 volt), Cat. No. 433 003 12V.

Spare 7" Sealed Beam Unit (32 volt), Cat. No. 433 003 32V.

## DECK CONTROL SEARCHLIGHT FIG. 534

Chrome Plated Brass Head  
with Chrome Plated Bronze Base

For 12, 24 or 32 Volts, 6 or 7 Inch Sealed Beam Bulb,  
Switch In Head



Fig. 534 002



Fig. 534 003

Voltage	O.D. Bulb Inches	Approx. Range Miles	Beam Candlepower	Wattage	ORDERING INFORMATION
					Catalog Number
12	6	1/2	200,000	100	534 002 12V
12	6	1/2	160,000	50	534 H02 12V*
12	7	5/8	250,000	100	534 003 12V
24	6	3/4	300,000	250	534 002 24V
24	7	3/4	470,000	450	534 003 24V
32	7	5/8	260,000	200	534 003 32V

Base Dimensions, 4 7/8 x 3 1/8 Inches.

Height Overall, No. 2 — 12 In., No. 3 — 12 1/2 In.

Weight, 5 Pounds.

\*NOTE: "H" in Catalog Number Designates a Halogen Bulb.

Spare 6" Sealed Beam Unit (12 volt), Cat. No. 433 002 12V.

Spare 6" Halogen Sealed Beam Unit (12 volt), Cat. No. 435 002 12V.

Spare 6" Sealed Beam Unit (24 volt), Cat. No. 433 002 24V.

Spare 7" Sealed Beam Unit (12 volt), Cat. No. 433 003 12V.

Spare 7" Sealed Beam Unit (24 volt), Cat. No. 433 003 24V.

Spare 7" Sealed Beam Unit (32 volt), Cat. No. 433 003 32V.

## PILOT HOUSE CONTROL SEARCHLIGHT FIG. 535

Chrome Plated Brass Head  
with Chrome Plated Bronze Base

For 12, 24 or 32 Volts, 6 or 7 Inch Sealed Beam Bulb,

Lever Handle Controls Both Horizontal and Vertical Movement.  
Control Length 7 1/4 In., Maximum Ceiling Thickness 4 1/2 In.

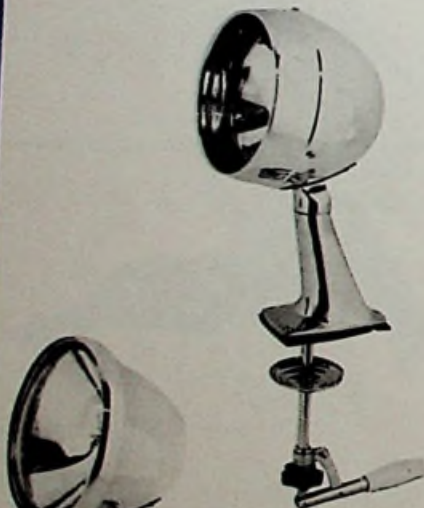

Fig. 535 002



Fig. 535 003

Voltage	O.D. Bulb Inches	Approx. Range Miles	Beam Candlepower	Wattage	ORDERING INFORMATION
					Catalog Number
12	6	1/2	200,000	100	535 002 12V
12	6	1/2	160,000	50	535 H02 12V*
12	7	5/8	250,000	100	535 003 12V
24	6	3/4	300,000	250	535 002 24V
24	7	3/4	470,000	450	535 003 24V
32	7	5/8	260,000	200	535 003 32V

Base Dimensions, 4 7/8 x 3 1/8 Inches.

Height Overall, No. 2 — 12 In., No. 3 — 12 1/2 In.

Weight, 5 Pounds.

\*NOTE: "H" in Catalog Number Designates a Halogen Bulb.

Spare 6" Sealed Beam Unit (12 volt), Cat. No. 433 002 12V.

Spare 6" Halogen Sealed Beam Unit (12 volt), Cat. No. 435 002 12V.

Spare 6" Sealed Beam Unit (24 volt), Cat. No. 433 002 24V.

Spare 7" Sealed Beam Unit (12 volt), Cat. No. 433 003 12V.

Spare 7" Sealed Beam Unit (24 volt), Cat. No. 433 003 24V.

Spare 7" Sealed Beam Unit (32 volt), Cat. No. 433 003 32V.



## SEALED BEAM SEARCHLIGHTS

### Bronze Base, Brass Body

### Polished Chrome Plated or White PERKO•KOTE

### For 12, 24 or 32 Volts

Dimensions (Inches)					
"A"	"B"	"C"	"D"	"G"	"H"
8	8½	10	7	2	2½

Electrical Specifications					
Voltage	Wattage	Candlepower	Approx. Range Miles	Sealed Beam Cat. No.	
12	100	250,000	5/8	433 003 12V	
24	450	470,000	¾	433 003 24V	
32	200	260,000	5/8	433 003 32V	

**Fig. 305 — Lever Control**

#### ORDERING INFORMATION For 12 Volt Searchlights

Control Length "E" Inches	Polished Chrome Cat. No.	White PERKO•KOTE Cat. No.	Weight Pounds	Control Only Cat. No.
8½	305 12V CHR	305 12V WHT	14	851 000
15½	305 A12 CHR	305 A12 WHT	14	851 0A0
22½	305 B12 CHR	305 B12 WHT	14	851 0B0
29½	305 C12 CHR	305 C12 WHT	14	851 0C0

NOTE: To Order the 24 or 32 Volt Versions of these Searchlights, Replace the "12" in the Cat. No. with "24" or "32" (e.g., Cat. No. 305 24V CHR For 24 Volts and Cat. No. 305 32V CHR For 32 Volts).

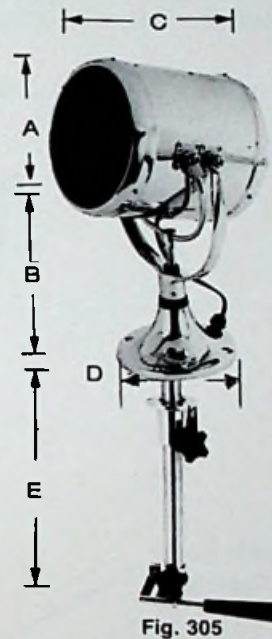

**Fig. 305**

**Fig. 313 — Wheel Control**

#### ORDERING INFORMATION For 12 Volt Searchlights

Control Length "F" Inches	Polished Chrome Cat. No.	White PERKO•KOTE Cat. No.	Weight Pounds	Control Only Cat. No.
7½	313 12V CHR	313 12V WHT	14	852 000
14½	313 A12 CHR	313 A12 WHT	14	852 0A0
21½	313 B12 CHR	313 B12 WHT	14	852 0B0
28½	313 C12 CHR	313 C12 WHT	14	852 0C0

NOTE: To Order the 24 or 32 Volt Versions of these Searchlights, Replace the "12" in the Cat. No. with "24" or "32" (e.g., Cat. No. 313 24V CHR For 24 Volts and Cat. No. 313 32V CHR For 32 Volts).



**Fig. 313**

## SOLAR-RAY® SEARCHLIGHTS — 800 SERIES 10", 12", or 14"

**CAST BRONZE AND HEAVY GAUGE BRASS  
POLISHED CHROME OR WHITE PERKO•KOTE FINISH  
12, 24, 32, 120 or 230 VOLTS**

The 800 Series — Solar-Ray® Searchlights are available in 10", 12" and 14" sizes with your choice of Deck, Wheel, Lever or Lever/Gear Controls. All models feature halo deflectors, parabolic glass mirror reflectors for maximum light output and ventilation covers for quick dissipation of heat to help prolong bulb life. Hinged front doors have quick release stainless steel latches to provide easy access for bulb replacement. The 800 Series models are now also available in our new white PERKO•KOTE finish, which eliminates painting and provides a scratch resistant and chip-proof surface.

Solar-Ray® Searchlights give you a choice of the traditional incandescent or the brighter, more piercing quartz-halogen bulbs in a broad variety of voltages and wattages to fit every need. For complete information on bulbs and candlepower output, see Pages 62 & 53.

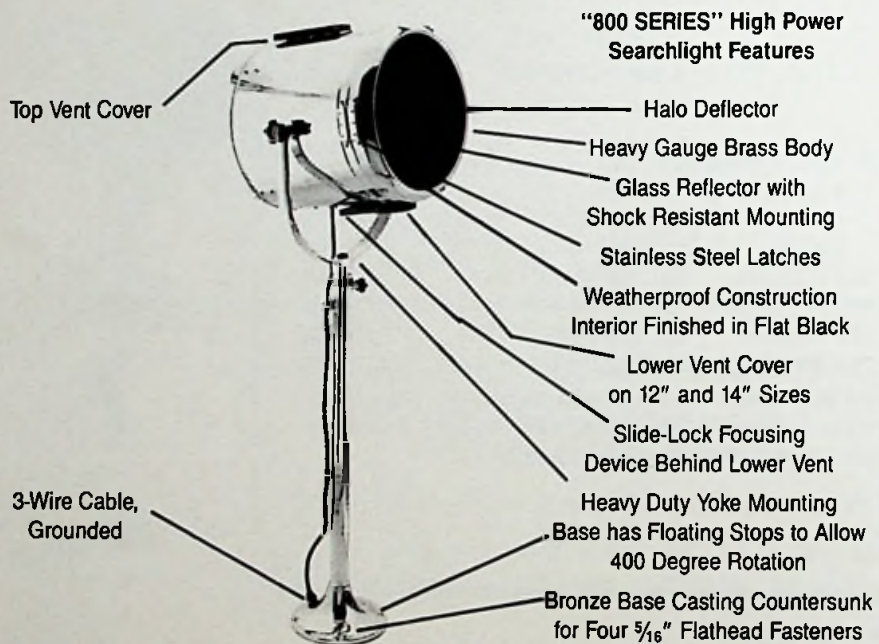

### CONTROL TYPES

#### DECK CONTROL

Equipped with handles on the rear cover for positioning.



#### LEVER CONTROL

Aim handle for horizontal position. Move handle up & down for vertical position.

#### WHEEL CONTROL

Turn upper wheel for horizontal position. Turn lower wheel for vertical position.

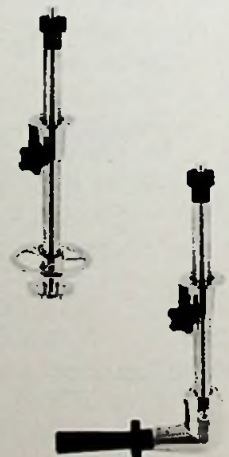

#### LEVER/GEAR CONTROL

Aim handle for horizontal position. Twist handle for vertical position.

## BULB TECHNICAL DATA FOR SOLAR-RAY® SEARCHLIGHTS

The following Chart is Provided to Aid in Proper Bulb Selection

Searchlight Size	Voltage	Bulb Catalog Number	Maximum Candlepower Output	Horizontal Beam Spread Degrees	Vertical Beam Spread Degrees	Approx. Range Miles*	Rated Life Hours**
10"	12	816	1,168,000	1.7	1.4	1	50
	24	836	891,000	2.6	1.5	1	50
	32	817	571,000	2.6	1.7	¾	200
	32	806	943,000	3.4	3.9	1	50
	120	820	908,000	4.4	2.2	1	75
	120	807	1,332,000	3.5	2.8	1½	25
	120	844	1,375,000	3.1	3.4	1½	100
12"	12	816	1,617,000	1.5	1.2	1¼	50
	24	836	1,349,000	2.2	1.5	1½	50
	32	817	865,000	2.4	1.6	7/8	200
	32	806	1,496,000	3.4	3.5	1½	50
	120	837	977,000	4.1	3.7	1	200
	120	845	1,185,000	3.7	5.2	1	200
	120	820	1,410,000	4.3	1.9	1½	75
	120	809	1,747,000	3.6	3.4	1¼	25
	120	844	1,790,000	3.2	3.4	1¼	100
	120	807	1,799,000	3.3	3.1	1¼	25
	120	811	1,816,000	4.0	4.9	1¼	25
	120	810	1,894,000	4.0	3.8	1¾	25
	120	846	1,911,000	3.9	5.0	1¾	200
	120	839	2,482,000	4.5	5.5	1½	75
	230	860	865,000	6.9	5.9	7/8	25
14"	12	816	1,756,000	1.5	1.0	1¼	50
	24	836	1,367,000	2.3	1.2	1½	50
	32	817	943,000	2.2	1.5	1	200
	32	806	1,591,000	4.0	3.7	1½	50
	120	837	1,254,000	3.9	4.5	1½	200
	120	845	1,531,000	3.6	5.1	1½	200
	120	820	1,626,000	4.5	1.9	1¼	75
	120	844	2,007,000	2.9	3.2	1¾	100
	120	811	2,249,000	4.0	5.1	1¾	25
	120	807	2,353,000	3.2	3.2	1½	25
	120	809	2,361,000	3.7	4.0	1½	25
	120	846	2,586,000	3.8	5.0	1½	200
	120	810	2,621,000	4.0	4.5	1½	25
	120	839	2,889,000	4.5	5.2	1¾	75
	230	860	1,021,000	7.7	6.2	1	50
19"	32	806	3,520,000	3.5	3.7	1¾	50
	120	837	2,076,000	3.6	4.2	1¾	200
	120	845	2,871,000	3.6	5.4	1¾	200
	120	807	3,191,000	3.5	4.0	1¾	25
	120	859	3,633,000	9.4	5.9	1¾	250
	120	847	3,659,000	4.5	5.4	1¾	200
	120	844	4,212,000	3.0	5.4	1¾	100
	120	809	4,454,000	3.6	4.5	1¾	25
	120	846	4,601,000	4.5	5.4	1¾	200
	120	848	5,596,000	5.9	5.7	2	100
	120	810	5,622,000	3.6	4.2	2	25
	120	839	5,769,000	5.9	5.4	2	75
	120	840	5,968,000	5.6	5.4	2½	25
	230	860	2,162,000	7.9	6.5	1¾	50

\*The approximate ranges listed above are based on photometric measurements of beam candlepower output under ideal conditions. Many factors such as atmospheric conditions, size and color of target, background, etc., may reduce effective range considerably; therefore, these figures are offered only for use as a guide to compare different bulb and voltage options.

\*\*Note: These are the "Rated Average Laboratory Life-Hours" of the Bulb Manufacturer. No Guarantee to the Time Indicated.

## DECK CONTROL SOLAR-RAY® SEARCHLIGHT 10", 12" and 14"

FIG. 883

### Searchlight Head Dimensions

Reflector Size Inches	Diameter "A" Front Door Inches	Length "C" Head Inches
10	10 $\frac{1}{8}$	13
12	12 $\frac{1}{8}$	15
14	14 $\frac{1}{8}$	17

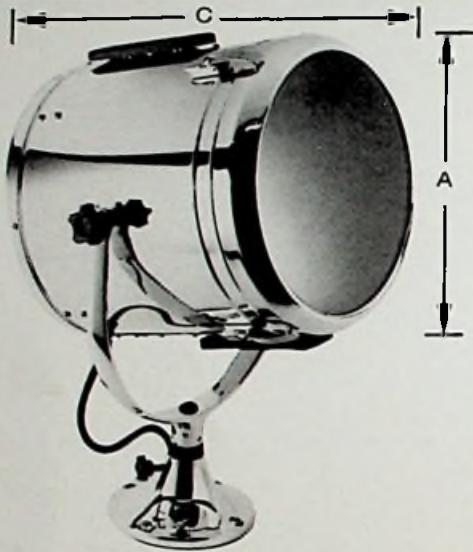

Fig. 883 — Standard Pedestal



Fig. 883 — High Pedestal

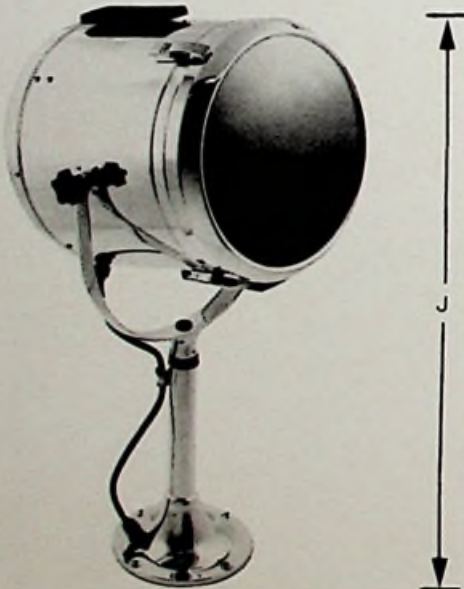

Fig. 883 — Medium Pedestal

NOTE: Custom Pedestal Heights are Available. Price Upon Application.  
Specify the "J" Dimension for Custom Pedestal Height.

## DECK CONTROL SOLAR-RAY® SEARCHLIGHT FIG. 883

### ORDERING INFORMATION

*NOTE: Refer to the Bulb Chart on Page 62 for the Bulb and Socket Ordering Information.*

#### Standard Pedestal

Reflector Size Inches	"J" Height Overall Inches	Polished Chrome Catalog No.	White PERKO•KOTE Catalog No.
10	20 $\frac{1}{8}$	883 001 CHR	883 001 WHT
12	22 $\frac{1}{8}$	883 002 CHR	883 002 WHT
14	25 $\frac{1}{8}$	883 003 CHR	883 003 WHT

Standard Pedestal Base: 7" Diameter.

#### Medium Pedestal

Reflector Size Inches	"J" Height Overall Inches	Polished Chrome Catalog No.	White PERKO•KOTE Catalog No.
10	27 $\frac{1}{2}$	883 M01 CHR	883 M01 WHT
12	29 $\frac{1}{2}$	883 M02 CHR	883 M02 WHT
14	31 $\frac{1}{2}$	883 M03 CHR	883 M03 WHT

Medium Pedestal Base: 8" Diameter.

#### High Pedestal

Reflector Size Inches	"J" Height Overall Inches	Polished Chrome Catalog No.	White PERKO•KOTE Catalog No.
10	44	883 H01 CHR	883 H01 WHT
12	46	883 H02 CHR	883 H02 WHT
14	48	883 H03 CHR	883 H03 WHT

High Pedestal Base: 8" Diameter.

## LEVER CONTROL SOLAR-RAY® SEARCHLIGHT 10", 12" and 14"

FIG. 884

### Dimensions

Reflector Size Inches	Diameter "A" Front Door Inches	Length "C" Head Inches	Standard Control Maximum Ceiling Thickness Inches
10	10 $\frac{1}{8}$	13	4 $\frac{1}{2}$
12	12 $\frac{1}{8}$	15	4 $\frac{1}{2}$
14	14 $\frac{1}{8}$	17	4 $\frac{1}{2}$

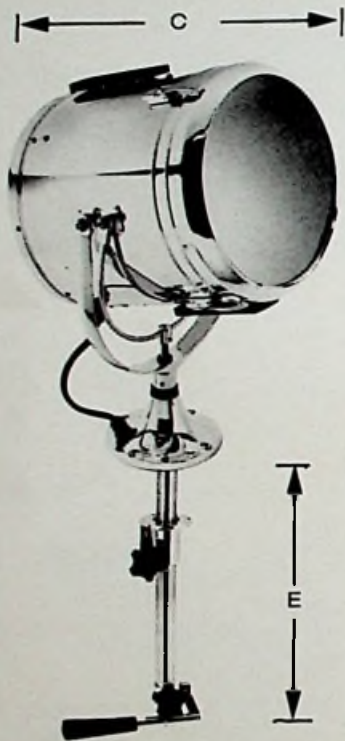

Fig. 884 — Standard Pedestal



Fig. 884 — Medium Pedestal



Fig. 884 — High Pedestal

NOTE: Custom Control Lengths and Pedestal Heights are Available. Price Upon Application.  
Specify the "E" Dimension for Custom Control Length.  
Specify the "J" Dimension for Custom Pedestal Height.

## LEVER CONTROL SOLAR-RAY® SEARCHLIGHT

FIG. 884

### ORDERING INFORMATION

NOTE: Refer to the Bulb Chart on Page 62 for the Bulb and Socket Ordering Information.

Reflector Size Inches	Standard Pedestal		Polished Chrome Catalog No.	White PERKO•KOTE Catalog No.	Head Only Polished Chrome Catalog No.	Head Only White PERKO•KOTE Catalog No.
	"E" Length Control Inches	"J" Height Overall Inches				
10	8½	20⅞	884 001 CHR	884 001 WHT	884 1HD CHR	884 1HD WHT
10	15½	20⅞	884 0A1 CHR	884 0A1 WHT		
10	22½	20⅞	884 0B1 CHR	884 0B1 WHT		
10	29½	20⅞	884 0C1 CHR	884 0C1 WHT		
12	8½	22⅞	884 002 CHR	884 002 WHT	884 2HD CHR	884 2HD WHT
12	15½	22⅞	884 0A2 CHR	884 0A2 WHT		
12	22½	22⅞	884 0B2 CHR	884 0B2 WHT		
12	29½	22⅞	884 0C2 CHR	884 0C2 WHT		
14	8½	25⅞	884 003 CHR	884 003 WHT	884 3HD CHR	884 3HD WHT
14	15½	25⅞	884 0A3 CHR	884 0A3 WHT		
14	22½	25⅞	884 0B3 CHR	884 0B3 WHT		
14	29½	25⅞	884 0C3 CHR	884 0C3 WHT		

Standard Pedestal Base: 7" Diameter.

Reflector Size Inches	Medium Pedestal		Polished Chrome Catalog No.	White PERKO•KOTE Catalog No.
	"E" Length Control Inches	"J" Height Overall Inches		
10	8½	28¼	884 M01 CHR	884 M01 WHT
10	15½	28¼	884 MA1 CHR	884 MA1 WHT
10	22½	28¼	884 MB1 CHR	884 MB1 WHT
10	29½	28¼	884 MC1 CHR	884 MC1 WHT
12	8½	30¼	884 M02 CHR	884 M02 WHT
12	15½	30¼	884 MA2 CHR	884 MA2 WHT
12	22½	30¼	884 MB2 CHR	884 MB2 WHT
12	29½	30¼	884 MC2 CHR	884 MC2 WHT
14	8½	33¼	884 M03 CHR	884 M03 WHT
14	15½	33¼	884 MA3 CHR	884 MA3 WHT
14	22½	33¼	884 MB3 CHR	884 MB3 WHT
14	29½	33¼	884 MC3 CHR	884 MC3 WHT

Medium Pedestal Base: 8" Diameter.

Reflector Size Inches	High Pedestal		Polished Chrome Catalog No.	White PERKO•KOTE Catalog No.
	"E" Length Control Inches	"J" Height Overall Inches		
10	8½	44¾	884 H01 CHR	884 H01 WHT
10	15½	44¾	884 HA1 CHR	884 HA1 WHT
10	22½	44¾	884 HB1 CHR	884 HB1 WHT
10	29½	44¾	884 HC1 CHR	884 HC1 WHT
12	8½	46¾	884 H02 CHR	884 H02 WHT
12	15½	46¾	884 HA2 CHR	884 HA2 WHT
12	22½	46¾	884 HB2 CHR	884 HB2 WHT
12	29½	46¾	884 HC2 CHR	884 HC2 WHT
14	8½	49¾	884 H03 CHR	884 H03 WHT
14	15½	49¾	884 HA3 CHR	884 HA3 WHT
14	22½	49¾	884 HB3 CHR	884 HB3 WHT
14	29½	49¾	884 HC3 CHR	884 HC3 WHT

High Pedestal Base: 8" Diameter.

## WHEEL CONTROL SOLAR-RAY<sup>®</sup> SEARCHLIGHT 10", 12" and 14"

FIG. 885

### Dimensions

Reflector Size Inches	Diameter "A" Front Door Inches	Length "C" Head Inches	Standard Control Maximum Ceiling Thickness Inches
10	10 $\frac{1}{2}$	13	3
12	12 $\frac{1}{2}$	15	3
14	14 $\frac{1}{2}$	17	3

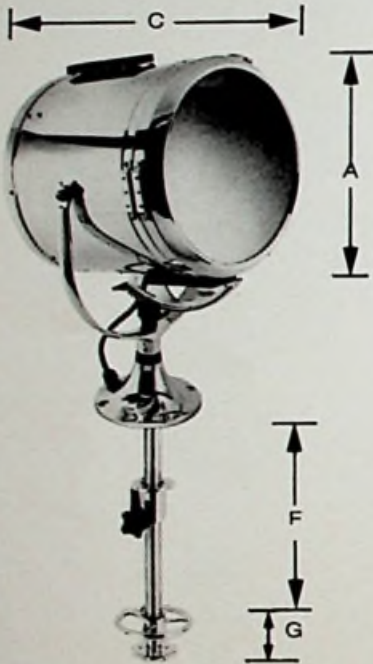

Fig. 885 — Standard Pedestal



Fig. 885 — Medium Pedestal



Fig. 885 — High Pedestal

NOTE: Custom Control Lengths and Pedestal Heights are Available. Price Upon Application.  
Specify the "F" Dimension for Custom Control Length.  
Specify the "J" Dimension for Custom Pedestal Height.



## WHEEL CONTROL SOLAR-RAY® SEARCHLIGHT

FIG. 885

### ORDERING INFORMATION

*NOTE: Refer to the Bulb Chart on Page 62 for the Bulb and Socket Ordering Information.*

Reflector Size Inches	Standard Pedestal		Polished Chrome Catalog No.	White PERKO•KOTE Catalog No.	Head Only Polished Chrome Catalog No.	Head Only White PERKO•KOTE Catalog No.
	"F" Length Control Inches	"J" Height Overall Inches				
10	7½	20⅞	885 001 CHR	885 001 WHT	885 1HD CHR	885 1HD WHT
10	14½	20⅞	885 0A1 CHR	885 0A1 WHT		
10	21½	20⅞	885 0B1 CHR	885 0B1 WHT		
10	28½	20⅞	885 0C1 CHR	885 0C1 WHT		
12	7½	22⅞	885 002 CHR	885 002 WHT	885 2HD CHR	885 2HD WHT
12	14½	22⅞	885 0A2 CHR	885 0A2 WHT		
12	21½	22⅞	885 0B2 CHR	885 0B2 WHT		
12	28½	22⅞	885 0C2 CHR	885 0C2 WHT		
14	7½	25⅞	885 003 CHR	885 003 WHT	885 3HD CHR	885 3HD WHT
14	14½	25⅞	885 0A3 CHR	885 0A3 WHT		
14	21½	25⅞	885 0B3 CHR	885 0B3 WHT		
14	28½	25⅞	885 0C3 CHR	885 0C3 WHT		

Standard Pedestal Base: 7" Diameter. Distance Between Control Wheels "G" is 2".

Reflector Size Inches	Medium Pedestal		Polished Chrome Catalog No.	White PERKO•KOTE Catalog No.
	"F" Length Control Inches	"J" Height Overall Inches		
10	7½	28¼	885 M01 CHR	885 M01 WHT
10	14½	28¼	885 MA1 CHR	885 MA1 WHT
10	21½	28¼	885 MB1 CHR	885 MB1 WHT
10	28½	28¼	885 MC1 CHR	885 MC1 WHT
12	7½	30¼	885 M02 CHR	885 M02 WHT
12	14½	30¼	885 MA2 CHR	885 MA2 WHT
12	21½	30¼	885 MB2 CHR	885 MB2 WHT
12	28½	30¼	885 MC2 CHR	885 MC2 WHT
14	7½	33¼	885 M03 CHR	885 M03 WHT
14	14½	33¼	885 MA3 CHR	885 MA3 WHT
14	21½	33¼	885 MB3 CHR	885 MB3 WHT
14	28½	33¼	885 MC3 CHR	885 MC3 WHT

Medium Pedestal Base: 8" Diameter. Distance Between Control Wheels "G" is 2".

Reflector Size Inches	High Pedestal		Polished Chrome Catalog No.	White PERKO•KOTE Catalog No.
	"F" Length Control Inches	"J" Height Overall Inches		
10	7½	44¾	885 H01 CHR	885 H01 WHT
10	14½	44¾	885 HA1 CHR	885 HA1 WHT
10	21½	44¾	885 HB1 CHR	885 HB1 WHT
10	28½	44¾	885 HC1 CHR	885 HC1 WHT
12	7½	46¾	885 H02 CHR	885 H02 WHT
12	14½	46¾	885 HA2 CHR	885 HA2 WHT
12	21½	46¾	885 HB2 CHR	885 HB2 WHT
12	28½	46¾	885 HC2 CHR	885 HC2 WHT
14	7½	49¾	885 H03 CHR	885 H03 WHT
14	14½	49¾	885 HA3 CHR	885 HA3 WHT
14	21½	49¾	885 HB3 CHR	885 HB3 WHT
14	28½	49¾	885 HC3 CHR	885 HC3 WHT

High Pedestal Base: 8" Diameter. Distance Between Control Wheels "G" is 2".

## LEVER/GEAR CONTROL SOLAR-RAY® SEARCHLIGHT 10", 12" and 14"

FIG. 886

### Dimensions

Reflector Size Inches	Diameter "A" Front Door Inches	Length "C" Head Inches	Standard Control Maximum Ceiling Thickness Inches
10	10 $\frac{1}{8}$	13	3 $\frac{1}{2}$
12	12 $\frac{1}{8}$	15	3 $\frac{1}{2}$
14	14 $\frac{1}{8}$	17	3 $\frac{1}{2}$

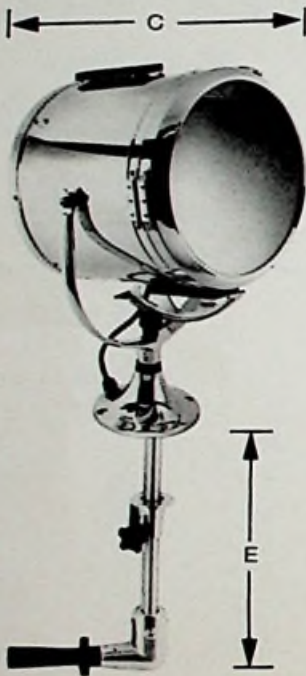

Fig. 886 — Standard Pedestal



Fig. 886 — Medium Pedestal

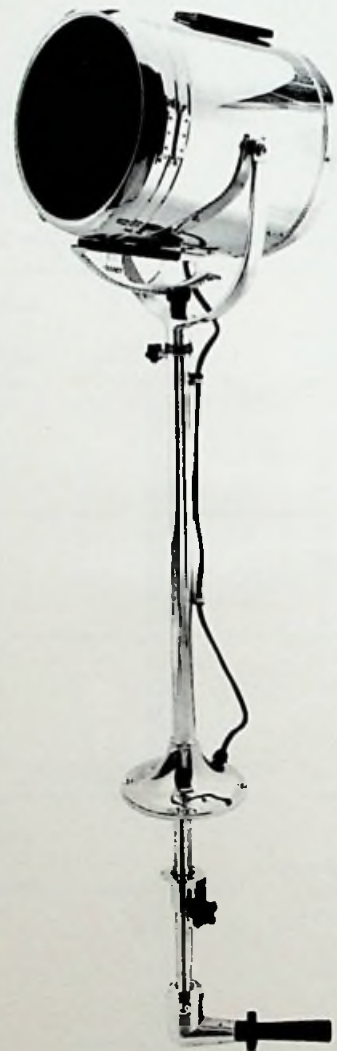

Fig. 886 — High Pedestal

NOTE: Custom Control Lengths and Pedestal Heights are Available. Price Upon Application.  
Specify the "E" Dimension for Custom Control Length.  
Specify the "J" Dimension for Custom Pedestal Height.

## LEVER/GEAR CONTROL SOLAR-RAY® SEARCHLIGHT FIG. 886

### ORDERING INFORMATION

NOTE: Refer to the Bulb Chart on Page 62 for the Bulb and Socket Ordering Information.

Reflector Size Inches	Standard Pedestal		Polished Chrome Catalog No.	White PERKO•KOTE Catalog No.	Head Only Polished Chrome Catalog No.	Head Only White PERKO•KOTE Catalog No.
	"E" Length Control Inches	"J" Height Overall Inches				
10	8½	20⅞	886 001 CHR	886 001 WHT	886 1HD CHR	886 1HD WHT
10	15½	20⅞	886 0A1 CHR	886 0A1 WHT		
10	22½	20⅞	886 0B1 CHR	886 0B1 WHT		
10	29½	20⅞	886 0C1 CHR	886 0C1 WHT		
12	8½	22⅞	886 002 CHR	886 002 WHT	886 2HD CHR	886 2HD WHT
12	15½	22⅞	886 0A2 CHR	886 0A2 WHT		
12	22½	22⅞	886 0B2 CHR	886 0B2 WHT		
12	29½	22⅞	886 0C2 CHR	886 0C2 WHT		
14	8½	25⅞	886 003 CHR	886 003 WHT	886 3HD CHR	886 3HD WHT
14	15½	25⅞	886 0A3 CHR	886 0A3 WHT		
14	22½	25⅞	886 0B3 CHR	886 0B3 WHT		
14	29½	25⅞	886 0C3 CHR	886 0C3 WHT		

Standard Pedestal Base: 7" Diameter.

Reflector Size Inches	Medium Pedestal		Polished Chrome Catalog No.	White PERKO•KOTE Catalog No.
	"E" Length Control Inches	"J" Height Overall Inches		
10	8½	28¼	886 M01 CHR	886 M01 WHT
10	15½	28¼	886 MA1 CHR	886 MA1 WHT
10	22½	28¼	886 MB1 CHR	886 MB1 WHT
10	29½	28¼	886 MC1 CHR	886 MC1 WHT
12	8½	30¼	886 M02 CHR	886 M02 WHT
12	15½	30¼	886 MA2 CHR	886 MA2 WHT
12	22½	30¼	886 MB2 CHR	886 MB2 WHT
12	29½	30¼	886 MC2 CHR	886 MC2 WHT
14	8½	33¼	886 M03 CHR	886 M03 WHT
14	15½	33¼	886 MA3 CHR	886 MA3 WHT
14	22½	33¼	886 MB3 CHR	886 MB3 WHT
14	29½	33¼	886 MC3 CHR	886 MC3 WHT

Medium Pedestal Base: 8" Diameter.

Reflector Size Inches	High Pedestal		Polished Chrome Catalog No.	White PERKO•KOTE Catalog No.
	"E" Length Control Inches	"J" Height Overall Inches		
10	8½	44¾	886 H01 CHR	886 H01 WHT
10	15½	44¾	886 HA1 CHR	886 HA1 WHT
10	22½	44¾	886 HB1 CHR	886 HB1 WHT
10	29½	44¾	886 HC1 CHR	886 HC1 WHT
12	8½	46¾	886 H02 CHR	886 H02 WHT
12	15½	46¾	886 HA2 CHR	886 HA2 WHT
12	22½	46¾	886 HB2 CHR	886 HB2 WHT
12	29½	46¾	886 HC2 CHR	886 HC2 WHT
14	8½	49¾	886 H03 CHR	886 H03 WHT
14	15½	49¾	886 HA3 CHR	886 HA3 WHT
14	22½	49¾	886 HB3 CHR	886 HB3 WHT
14	29½	49¾	886 HC3 CHR	886 HC3 WHT

High Pedestal Base: 8" Diameter.

## IMPORTANT BULB INFORMATION FOR SOLAR-RAY® SEARCHLIGHTS — 800 SERIES 10", 12" and 14"

### BULBS ARE NOT INCLUDED IN LIGHTS

To Give Good Results, the Bulb and Reflector Must be Perfectly Compatible; Therefore be sure to Specify the Catalog Number of the Bulb Desired. Peak Candlepower is Exceedingly Sensitive to Many Factors, (i.e., a Light Source Out of Focus by  $\frac{1}{32}$  Inch, Under-voltage of only 4%, or Differences Between Bulb Manufacturers, Can Cause a Reduction of Range of up to 20%).

### INCANDESCENT BULB ORDERING INFORMATION

Bulb Catalog Number	Voltage	Wattage	Socket Type	Socket Code Letter	For Searchlight Size Inches	Rated* Life Hours	Mfg. Bulb Code
806	32	500	Medium Screw	B	10, 12, 14	50	DLT
807	120	500	Medium Prefocus	E	10, 12, 14	25	CZX
809	120	750	Medium Prefocus	E	12, 14	25	DPJ
837	120	750	Medium Prefocus	E	12, 14	200	DDY
810	120	1000	Medium Prefocus	E	12, 14	25	DRS
811	120	1000	Mogul Screw	D	12, 14	25	DRW
860	230	1000	Medium Prefocus	E	12, 14	50	DWK

For a More Concentrated Beam, Longer Range, Brighter Light and a Longer Life, We Recommend the Following Bulbs.

### "QUARTZ" TUNGSTEN-HALOGEN BULB ORDERING INFORMATION

Bulb Catalog Number	Voltage	Wattage	Socket Type	Socket Code Letter	For Searchlight Size Inches	Rated* Life Hours	Mfg. Bulb Code
816	12	100	2-Pin Prefocus	F	10, 12, 14	50	FDT
836	24	150	2-Pin Prefocus	G	10, 12, 14	50	DZE-FDS
817	32	200	2-Pin Prefocus	H	10, 12, 14	200	G.E. 1945
844	120	500	Medium Prefocus	E	10, 12, 14	100	BTM
820	120	600	2-Pin Prefocus	I	10, 12, 14	75	DYS
845	120	750	Medium Prefocus	E	12, 14	200	BTP
839	120	900	2-Pin Prefocus	K	12, 14	75	BVA
846	120	1000	Medium Prefocus	E	12, 14	200	BTR

*Bulbs are Not Returnable Unless the Fault Is Ours.*

*\*NOTE: These are the "Rated Average Laboratory Life in Hours" of the Bulb Manufacturer. No Guarantee to the Time Indicated.*

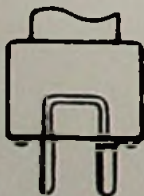

2-Pin Prefocus



Mogul Screw



Medium Prefocus



Medium Screw

## 19" SOLAR-RAY® SEARCHLIGHTS — 1900 SERIES

**ALL ALUMINUM — WHITE PERKO•KOTE FINISH**  
**32, 120 or 230 VOLTS**

The 1900 Series — Solar-Ray® Searchlights are designed and built with the commercial user in mind where maximum size and brilliance counts. These units are constructed of marine aluminum with heavy duty castings and heavy gauge reinforced bodies for extra durability.

The 1900 Series is available with Deck, Wheel or Lever/Gear Controls. All models feature halo deflectors, parabolic glass mirror reflectors for maximum light output and ventilation covers for quick dissipation of heat to help prolong bulb life. Hinged front doors have quick release stainless steel latches to provide easy access for bulb replacement.

Solar-Ray® Searchlights give you a choice of the traditional incandescent or the brighter, more piercing quartz-halogen bulbs in a variety of voltages and wattages. For complete information on bulbs and candlepower output, see Pages 66 & 53.

### "1900 SERIES" High Power Searchlight Features

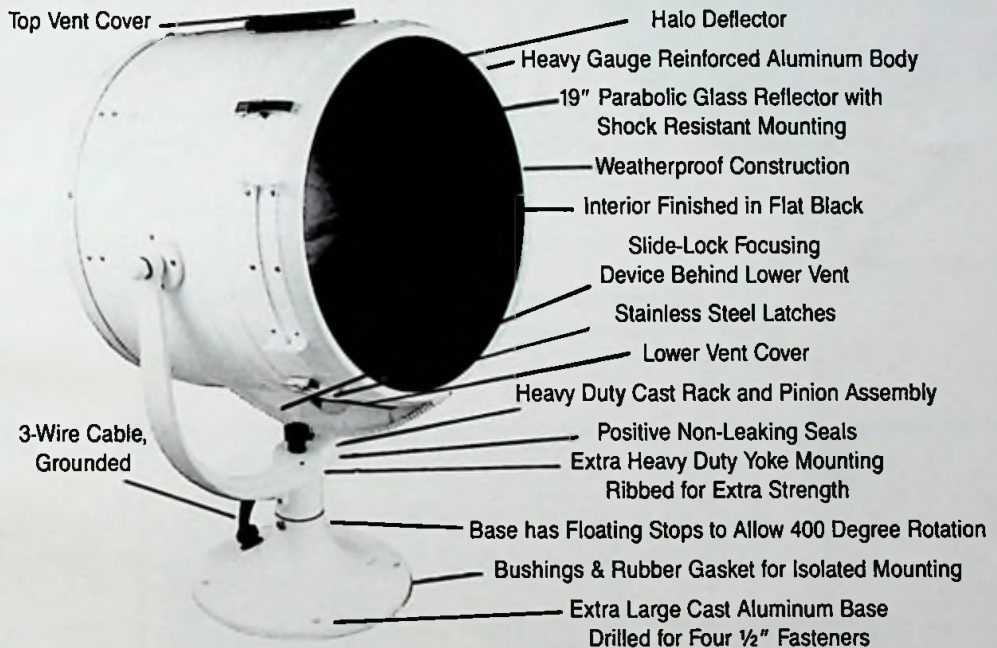

### CONTROL TYPES

#### DECK CONTROL

Equipped with handles on the rear cover for positioning.

#### WHEEL CONTROL

Turn upper wheel for horizontal position. Turn lower wheel for vertical position.

#### LEVER/GEAR CONTROL

Aim handle for horizontal position. Twist handle for vertical position.



## 19 INCH SOLAR-RAY® SEARCHLIGHTS

## FIGS. 1901, 1902 & 1903

### Searchlight Head Dimensions

Reflector Size Inches	Diameter "A" Front Door Inches	Length "C" Head Inches
19	19½	20¾



Fig. 1902 — Lever/Gear Control



Fig. 1901 — Deck Control



Fig. 1903 — Wheel Control

## 19 INCH SOLAR-RAY® SEARCHLIGHTS      FIGS. 1901, 1902 & 1903

### ORDERING INFORMATION

*NOTE: Refer to the Bulb Chart on Page 66 for the Bulb and Socket Ordering Information.*

#### Fig. 1901 — Deck Control

"J" Height Overall Inches	Diameter "D" Pedestal Base Inches	White PERKO•KOTE Catalog No.
32¾	13	1901 000 WHT

#### Fig. 1902 — Lever/Gear Control

"E" Length Control Inches	"J" Height Overall Inches	Diameter "D" Pedestal Base Inches	White PERKO•KOTE Catalog No.	Control Assembly Only Catalog No.
22	32¾	13	1902 000 WHT	1921 000 WHT

#### Fig. 1903 — Wheel Control

"F" Length Control Inches	"J" Height Overall Inches	Diameter "D" Pedestal Base Inches	White PERKO•KOTE Catalog No.	Control Assembly Only Catalog No.
20½	32¾	13	1903 000 WHT	1922 000 WHT

Distance Between Control Wheels is 2½".

*Custom Control Lengths and Pedestal Heights are Available.  
Price Upon Application. Specify Measurements.*

## ELECTRIC SOCKET AND SUPPORT STAND ASSEMBLIES FOR 1900 SERIES SOLAR-RAY® SEARCHLIGHTS

Solar-Ray® Searchlights include a socket, support stand and slide focus assembly based on the bulb or socket information given when ordering. The following chart makes it possible to order and stock different assemblies for field conversion, to meet a large variety of voltage and candlepower requirements with a minimum of inventory.

### ORDERING INFORMATION

Socket Type	Catalog Number	Height Stand Inches
Medium Screw	872 004	5¾
Medium Prefocus	873 004	5⅞
Mogul Prefocus (1500 Watt)	1930	3⅝
Mogul Prefocus (1000 & 2000 Watt)	1931	3⅞
2-Pin Prefocus (900 Watt)	880 004	7⅞

## IMPORTANT BULB INFORMATION FOR 19" SOLAR-RAY® SEARCHLIGHTS — 1900 SERIES

### BULBS ARE NOT INCLUDED IN LIGHTS

To Give Good Results, the Bulb and Reflector Must be Perfectly Compatible; Therefore be sure to Specify the Catalog Number of the Bulb Desired. Peak Candlepower is Exceedingly Sensitive to Many Factors, (i.e., a Light Source Out of Focus by  $\frac{1}{32}$  Inch, Under-voltage of only 4%, or Differences Between Bulb Manufacturers, Can Cause a Reduction of Range of up to 20%).

### INCANDESCENT BULB ORDERING INFORMATION

Bulb Catalog Number	Voltage	Wattage	Socket Type	Socket Code Letter	Rated* Life Hours	Mfg. Bulb Code
806	32	500	Medium Screw	B	50	DLT
807	120	500	Medium Prefocus	E	25	CZX
809	120	750	Medium Prefocus	E	25	DPJ
837	120	750	Medium Prefocus	E	200	DDY
810	120	1000	Medium Prefocus	E	25	DRS
840	120	1500	Mogul Prefocus	L	25	DTJ
860	230	1000	Medium Prefocus	E	50	DWK

For a More Concentrated Beam, Longer Range, Brighter Light and a Longer Life, We Recommend the Following Bulbs.

### "QUARTZ" TUNGSTEN-HALOGEN BULB ORDERING INFORMATION

Bulb Catalog Number	Voltage	Wattage	Socket Type	Socket Code Letter	Rated* Life Hours	Mfg. Bulb Code
844	120	500	Medium Prefocus	E	100	BTM
845	120	750	Medium Prefocus	E	200	BTP
839	120	900	2-Pin Prefocus	K	75	BVA
846	120	1000	Medium Prefocus	E	200	BTR
847	120	1000	Mogul Prefocus	M	200	BVV
848	120	1500	Mogul Prefocus	L	100	DTA
859	120	2000	Mogul Prefocus	M	250	BVW

*Bulbs are Not Returnable Unless the Fault Is Ours.*

*\*NOTE: These are the "Rated Average Laboratory Life in Hours" of the Bulb Manufacturer. No Guarantee to the Time Indicated.*

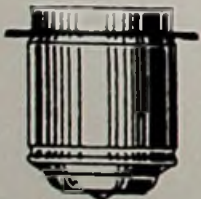

Mogul Prefocus



Medium Prefocus



Medium Screw



2-Pin Prefocus



## CONTROL ASSEMBLIES FOR 800 SERIES SOLAR-RAY® SEARCHLIGHTS

Control Assemblies of different lengths may be interchanged on Solar-Ray® Searchlights of the same pedestal height. The following chart makes it possible to order and stock different styles of these assemblies separately to offer a large variety of Solar-Ray® Searchlights with a minimum of inventory.

### ORDERING INFORMATION

Control Type	Length Control Inches	Standard Pedestal Cat. No.	Medium Pedestal Cat. No.	High Pedestal Cat. No.
Lever	8½	851 000	851 M00	851 H00
Lever	15½	851 0A0	851 MA0	851 HA0
Lever	22½	851 0B0	851 MB0	851 HB0
Lever	29½	851 0C0	851 MC0	851 HC0
Wheel	7½	852 000	852 M00	852 H00
Wheel	14½	852 0A0	852 MA0	852 HA0
Wheel	21½	852 0B0	852 MB0	852 HB0
Wheel	28½	852 0C0	852 MC0	852 HC0
Lever/Gear	8½	969 000	969 M00	969 H00
Lever/Gear	15½	969 0A0	969 MA0	969 HA0
Lever/Gear	22½	969 0B0	969 MB0	969 HB0
Lever/Gear	29½	969 0C0	969 MC0	969 HC0

## ELECTRIC SOCKET AND SUPPORT STAND ASSEMBLIES FOR 800 SERIES SOLAR-RAY® SEARCHLIGHTS

Solar-Ray® Searchlights include a socket, support stand and slide focus assembly based on the bulb or socket information given when ordering. The following chart makes it possible to order and stock different assemblies for field conversion, to meet a large variety of voltage and candlepower requirements with a minimum of inventory.

### ORDERING INFORMATION

Socket Type	For 10" Searchlights		For 12" Searchlights		For 14" Searchlights	
	Catalog Number	Height Stand Inches	Catalog Number	Height Stand Inches	Catalog Number	Height Stand Inches
Medium Screw	872 001	1¼	872 002	2¼	872 003	3¼
Medium Prefocus	873 001	1½ <sub>16</sub>	873 002	1 <sup>15</sup> / <sub>16</sub>	873 003	2 <sup>15</sup> / <sub>16</sub>
Mogul Screw	-----	-----	874 002	7 <sub>16</sub>	874 003	1¼
2-Pin Prefocus (12 Volt)	875 001	3½	875 002	4½	875 003	5½
2-Pin Prefocus (24 Volt)	876 001	3¼	876 002	4¼	876 003	5¼
2-Pin Prefocus (32 Volt)	878 001	3¼	878 002	4¼	878 003	5¼
2-Pin Prefocus (600 watt)	879 001	3 <sup>1</sup> / <sub>8</sub>	879 002	4 <sup>1</sup> / <sub>8</sub>	879 003	5 <sup>1</sup> / <sub>8</sub>
2-Pin Prefocus (900 watt)	-----	-----	880 002	3 <sup>13</sup> / <sub>16</sub>	880 003	4 <sup>13</sup> / <sub>16</sub>

## SPARE PARTS FOR SOLAR-RAY® SEARCHLIGHTS

Fig.	Size	Front Glass	Front Door with Glass	Focusing Device with Housing	Rear Cover	Reflector*	Pinion Gear
883	10"	889 001 CLR	891 001 CHR	892 000 CHR	908 001 CHR	890 001	---
883	12"	889 002 CLR	891 002 CHR	892 000 CHR	908 002 CHR	890 002	---
883	14"	889 003 CLR	891 003 CHR	892 000 CHR	908 003 CHR	890 003	---
884	10"	889 001 CLR	891 001 CHR	892 000 CHR	902 001 CHR	890 001	---
884	12"	889 002 CLR	891 002 CHR	892 000 CHR	902 002 CHR	890 002	---
884	14"	889 003 CLR	891 003 CHR	892 000 CHR	902 003 CHR	890 003	---
885	10"	889 001 CLR	891 001 CHR	909 001 CHR	902 001 CHR	890 001	905
885	12"	889 002 CLR	891 002 CHR	909 002 CHR	902 002 CHR	890 002	905
885	14"	889 003 CLR	891 003 CHR	909 003 CHR	902 003 CHR	890 003	905
886	10"	889 001 CLR	891 001 CHR	909 001 CHR	902 001 CHR	890 001	905
886	12"	889 002 CLR	891 002 CHR	909 002 CHR	902 002 CHR	890 002	905
886	14"	889 003 CLR	891 003 CHR	909 003 CHR	902 003 CHR	890 003	905
1901	19"	889 004 CLR	1936 000 WHT	1934 000 WHT	1932 000 WHT	890 004	---
1902	19"	889 004 CLR	1936 000 WHT	1935 000 WHT	1933 000 WHT	890 004	905
1903	19"	889 004 CLR	1936 000 WHT	1935 000 WHT	1933 000 WHT	890 004	905

NOTE: The 800 Series Parts Above are Listed For the Polished Chrome (CHR) Finish. To Order White Finish, Replace the "CHR" in the Catalog Number with the "WHT" Finish Code.

\*Replacement Retaining Clips for the Reflector Should Also Be Ordered When Ordering a Replacement Reflector to Assure a Proper Fit.

Reflector Clip Sets For 800 Series, Cat. No. 910.

Reflector Clip Sets For 1900 Series, Cat. No. 911.



Medium Screw Socket "B"  
Catalog No. 894



Medium Prefocus Socket "E"  
Catalog No. 895

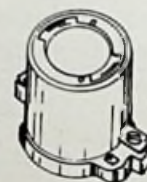

Mogul Prefocus Socket "L & M"  
Catalog No. 893

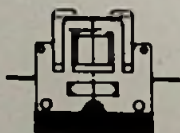

2-Pin Prefocus Socket\*  
Catalog No. 899

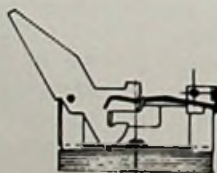

2-Pin Prefocus Socket "K"\*\*\*  
Catalog No. 866



Mogul Screw Socket "D"  
Catalog No. 897

\*For Use In 10", 12" and 14" Searchlights Except When the Catalog No. 839, 900 watt Bulb is Used (Socket Codes F, G, H & I).  
\*\*For Use In 12", 14" and 19" Searchlights Only When the Catalog No. 839, 900 watt Bulb is Used.

## VAPOR PROOF LIGHT FIXTURES FIGS. 1087 & 1090

Satin Finish Die Cast Aluminum with Glass Globes  
Integral Junction Box with Four ½ Inch I.P.S. Tappings.

Fig. 1087, Ceiling Mount Fig. 1090, Bulkhead Mount

Medium Screw Socket for Bulbs up to 100 watts. Bulb Not Included.

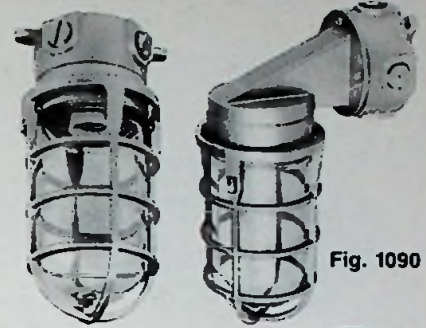

Fig. 1087

Fig. 1090

### ORDERING INFORMATION

O.D. Box Inches	Length Overall Inches	Projection Inches	Standard Pkg.-1 pc.	Bolt Size	Weight Pounds
3¾	9½	—	1087 000 ALU	¼	3
3¾	10	7	1090 000 ALU	¼	3¼

Note: These Fixtures are listed in accordance with U.L. Standard 57, for enclosed gasketed fixtures.

Not evaluated for use in hazardous or explosive atmospheres.

Spare Guards, Cat. Nos. 1087 000 99A & 1090 000 99A.  
Spare Sockets, Cat. Nos. 1087 000 99B & 1090 000 99B.

Spare Globes, Cat. Nos. 1087 000 99C & 1090 000 99C.



LISTED BY  
UNDERWRITERS  
LABORATORIES

## UNIVERSAL OIL LAMP FIG. 312

Polished Brass

### ORDERING INFORMATION

Height Overall Inches	Chimney Height Inches	Diameter Fount Inches	Standard Pkg.-1 pc.	Capacity Fount Fluid Ounces	Weight Pounds
11¾	8½	5	312 000 POL	21	1½

Spare Chimney, Cat. No. 94 000 CLR.  
Spare Wick, Cat. No. 302 002.

Spare Burner, Cat. No. 173 000 PLB.



Fig. 312

## BULKHEAD MOUNT OIL LAMPS FIGS. 168 & 141

Polished or Chrome Plated Brass  
Gimbaled with Weighted Base

### ORDERING INFORMATION

Height Overall Inches	Height Chimney Inches	Extension Overall Inches	Polished Brass Standard Pkg.-1 pc.	Chrome Plated Brass Standard Pkg.-1 pc.	Capacity Fount Fluid Ounces	Weight Pounds
9	5	5	168 000 POL	168 000 CHR	7	1¼
10½	4⅝	5½	141 001 POL	141 001 CHR	12	1¾
12½	6	6	141 002 POL	141 002 CHR	19	2

Screw Size #8.

Spare Chimney, Figs. 168 & 141 Size No. 1, Cat. No. 230 000 CLR.

Spare Wick, Figs. 168 & 141 Size No. 1, Cat. No. 302 00A.

Spare Burner, Figs. 168 & 141 Size No. 1, Cat. No. 231 000 PLB or 231 000 CHR.

Spare Chimney, Fig. 141 Size No. 2, Cat. No. 267 000 CLR.

Spare Wick, Fig. 141 Size No. 2, Cat. No. 302 002.

Spare Burner, Fig. 141 Size No. 2, Cat. No. 242 000 PLB or 242 000 CHR.



Figs. 168 & 141

## SMOKE BELL AND ARM FIG. 128

Polished or Chrome Plated Brass

### ORDERING INFORMATION

For Lamp Fig. No.	Polished Brass Std. Pkg.-1 pc.	Chrome Plated Brass Std. Pkg.-1 pc.	O.D. Bell Inches	Extension to Center Inches	Screw Size	Weight Ounces
168	128 000 POL	128 000 CHR	4	3½	8	4
*141	128 001 POL	128 001 CHR	4	4	8	4

\*Fits Both Sizes 1 and 2.



Fig. 128

## FLUSH MOUNT DOME LIGHT FIG. 308



Fig. 308

**Double Contact Bayonet Socket  
Push Switch with Water Resistant Boot  
Complete with 12 Volt Bulb**

**Chrome Plated Zinc**

### ORDERING INFORMATION

O.D. Globe Inches	O.D. Flange Inches	Depth Above Flange Inches	Depth Below Flange Inches	Max. Candle Power	Std. Pkg.-1 pc. OEM Pkg.-10 pcs.	Screw Size	Weight Ounces
3	3¾	5/8	¾	15	308 000 CHR	10 R.H.	5
4	4½	¾	1¼	21	308 001 CHR	10 R.H.	7
5	5½	¾	1½	21	*308 002 CHR	12 R.H.	9

\*No OEM Package Available

Spare Bulbs (2 per bag) for 3 Inch Light, Cat. No. 337 011 DP.  
Spare Bulbs (2 per bag) for 4 Inch Light, Cat. No. 337 012 DP.  
Spare Bulbs (2 per bag) for 5 Inch Light, Cat. No. 337 013 DP.

Spare Switch, Cat. No. 701 DP.  
Spare Socket, Cat. No. 24 DP1.  
Spare Globe, Fig. No. 257 DP, Specify Size.

## SURFACE MOUNT DOME LIGHT FIG. 300



Fig. 300

**Double Contact Bayonet Socket  
Push Switch with Water Resistant Boot  
Complete with 12 Volt Bulb**

**Chrome Plated Zinc**

### ORDERING INFORMATION

O.D. Globe Inches	O.D. Base Inches	Depth Overall Inches	Max. Candle Power	Display Pkg.-5 cds. 1 Pc. per card	Std. Pkg.-5 pcs. OEM Pkg.-10 pcs.	Screw Size	Weight Ounces
3	3¾	1½	15	300 DP0 CHR	*300 000 CHR	10 R.H.	7
4	5	1⅞	21	300 DP1 CHR	300 001 CHR	10 R.H.	9
5	6	2	21	300 DP2 CHR	300 002 CHR	12 R.H.	11

\*OEM Package-20 pcs.

Spare Bulbs (2 per bag) for 3 Inch Light, Cat. No. 337 011 DP.  
Spare Bulbs (2 per bag) for 4 Inch Light, Cat. No. 337 012 DP.  
Spare Bulbs (2 per bag) for 5 Inch Light, Cat. No. 337 013 DP.

Spare Switch, Cat. No. 701 DP.  
Spare Socket, Cat. No. 24 DP1.  
Spare Globe, Fig. No. 257 DP, Specify Size.

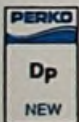

## EXTERIOR DOME LIGHT FIG. 1253



Fig. 1253

**Double Contact Bayonet Socket  
Push Switch with Water Resistant Boot  
Complete with 12 Volt Bulb**

**Ivory Perko-Kote Powder Coating  
Black Vinyl Mounting Gasket**

### ORDERING INFORMATION

O.D. Globe Inches	O.D. Base Inches	Depth Overall Inches	Max. Candle Power	Display Pkg.-5 cds. 1 Pc. per card	Std. Pkg.-5 pcs. OEM Pkg.-10 pcs.	Screw Size	Weight Ounces
4	5	1⅞	21	1253 DP1 WHT	1253 001 WHT	10 R.H.	9
5	6	2	21	1253 DP2 WHT	1253 002 WHT	12 R.H.	11

Spare Bulbs (2 per bag) for 4 Inch Light, Cat. No. 337 012 DP.  
Spare Bulbs (2 per bag) for 5 Inch Light, Cat. No. 337 013 DP.  
Spare Switch, Cat. No. 701 DP.

Spare Socket, Cat. No., 24 DP1.  
Spare Globe, Fig. No. 257 DP, Specify Size.

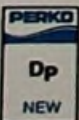

## SURFACE MOUNT LIGHT FIG. 318A

**Dual Voltage, For 12 or 120 Volts  
Double Contact Bayonet Sockets,  
Complete with two 12 Volt and two 120 Volt Bulbs.**

**White Translucent Plastic Globe  
White Perko-Kote Cast Zinc Base  
with Integral Junction Box**

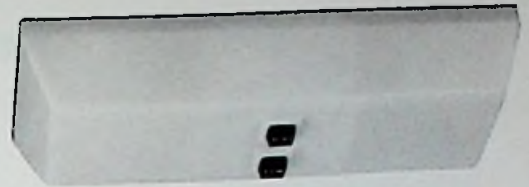

Fig. 318A

### ORDERING INFORMATION

Length Inches	Width Inches	Depth Inches	Display Pkg.-5 cds. 1 Pc. per card	Std. Pkg.-5 pcs. OEM Pkg.-10 pcs.	Screw Size	Weight Pounds
9¾	3½	1⅞	318 DP	318 A00	10	1⅞

Spare 12 Volt Bulbs (2 per bag), Cat. No. 337 012 DP.

Spare Socket, Cat. No. 24 DP1.

Spare 120 Volt Bulbs (2 per bag), Cat. No. 337 023 DP.

Spare Globe, Cat. No. 318 A00 99D.

Spare Switches with Square Buttons (1 Each High and Low), Cat. No. 318 A00 99E.



## SURFACE MOUNT DOME LIGHT FIG. 555

**Medium Screw Socket, Toggle Switch  
Uses 15 Watt, A-17 Bulb, Not Included**

**Chrome Plated Bronze**



Fig. 555

### ORDERING INFORMATION

O.D. Globe Inches	O.D. Base Inches	Depth Inches	Standard Pkg.-1 pc.	Screw Size	Weight Pounds
6	7⅞	3⅞	555 000 CHR	8	4½

Spare Switch, Cat. No. 514 DP.

Spare Socket, Cat. No. 346 001.

Spare Globe, Cat. No. 257 DP6.

## SURFACE MOUNT DOME LIGHT FIG. 753

**Medium Screw Sockets, Toggle Switches  
Bulbs Not Included**

**Size No. 1 has one socket and switch.  
Will accommodate bulbs up to 50 watts.  
Size No. 2 has two sockets and switches.  
Will accommodate bulbs up to 25 watts.**

**Chrome Plated Wrought Brass**



Fig. 753

### ORDERING INFORMATION

O.D. Glass Inches	O.D. Base Inches	Depth Inches	Standard Pkg.-1 pc.	Screw Size	Weight Pounds
8	9½	3	753 001 CHR	10	2½
8	9½	3	753 002 CHR	10	2¾

Spare Switch, Cat. No. 514 DP.

Spare Socket, Cat. No. 1323.

Spare Globe, Cat. No. 132 000 FRD.

## ADJUSTABLE UTILITY LIGHT FIG. 1254



Fig. 1254

**Shield Swivels to Change Position**

**Complete with 12 Volt, 6 C.P. Bulb**

**Chrome Plated Zinc**

### ORDERING INFORMATION

O.D. Overall Inches	Length Neck Inches	O.D. Neck Inches	Display Pkg.-5 cards 1 Pc. per card	Std. Pkg.-5 pcs. OEM Pkg.-10 pcs.	Screw Size	Weight Ounces
2 <sup>5</sup> / <sub>8</sub>	3/4	7/8	1254 DP CHR	1254 000 CHR	6	6

Spare Bulbs (2 per bag) , Cat. No. 337 011,DP.  
Spare Socket, Cat. No. 24 DP1.



## FIXED UTILITY LIGHT FIG. 1044

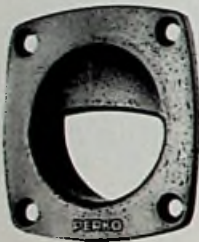

Fig. 1044

**Complete with 12 Volt, 3 Watt Bulb**

**Molded Plastic, Black or White**

**Easily Installed by Cutting a 1<sup>3</sup>/<sub>4</sub>" Diameter Hole**

### ORDERING INFORMATION

Color	Dimensions Inches	Depth Inches	Display Pkg.-10 bags 1 Pc. per bag	OEM Pkg.-100 pcs.	Weight Ounces
Black	2 <sup>1</sup> / <sub>4</sub> x 2 <sup>1</sup> / <sub>4</sub>	1 <sup>5</sup> / <sub>16</sub>	1044 DP BLK	1044 000 BLK	1
White	2 <sup>1</sup> / <sub>4</sub> x 2 <sup>1</sup> / <sub>4</sub>	1 <sup>5</sup> / <sub>16</sub>	1044 DP WHT	1044 000 WHT	1

Spare Bulb, Cat. No. 1044 000 99A.

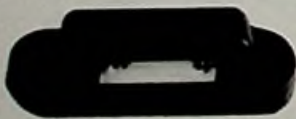

Fig. 137

## FIXED UTILITY LIGHTS FIGS. 137 & 140

**Complete with 12 Volt, 1 Watt Bulb**

**Fig. 137, Shielded Utility Light, Molded Black Plastic**  
**Fig. 140, Diffused Utility Light, Molded White Plastic**

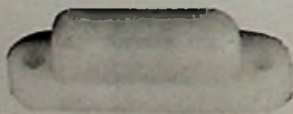

Fig. 140

### ORDERING INFORMATION

Size Inches	Display Pkg.-10 bags 1 Pc. per bag	OEM Pkg.-100 pcs.	Screw Size	Weight Ounces
1 <sup>1</sup> / <sub>8</sub> x 5/8	137 DP BLK	137 000 BLK	6	1/2
1 <sup>1</sup> / <sub>8</sub> x 5/8	140 DP NYN	140 000 NYN	6	1/2



## ADJUSTABLE SPREADER LIGHT FIG. 1040

Complete with 12 Volt Sealed Beam Unit

Molded Black Plastic Body  
Chrome Plated Brass Mounting Bracket



Fig. 1040



Voltage	O.D. Inches	Depth Inches	Dimensions		ORDERING INFORMATION		Weight Pounds
			Bracket Inches	Display Pkg.-5 bxs. 1 Pc. per box	Standard Pkg.-5 pcs.		
12	4½	4½	4½ x 1	1040 DP 12V	1040 000 12V	1½	

Screw Size #12 R.H.

Spare Sealed Beam Unit, Cat. No. 432 000 12V.

NOTE: To Use The Above Light in a 24 or 32 Volt System, Order Replacement Bulb Cat. No. 432 000 24V or 432 000 32V.

## ADJUSTABLE SPREADER LIGHT FIG. 280

Complete with 12 Volt Sealed Beam Unit

Chrome Plated Brass



Fig. 280



Voltage	O.D. Inches	Depth Inches	Dimensions		ORDERING INFORMATION		Weight Pounds
			Bracket Inches	Display Pkg.-5 bxs. 1 Pc. per box	Std. Pkg.-5 pcs. OEM Pkg.-10 pcs.		
12	4⅝	2½	5⅞ x ¾	280 DP 12V	280 000 12V	1½	

Screw Size #12 R.H.

Spare Sealed Beam Unit, Cat. No. 432 000 12V.

NOTE: To Use The Above Light in a 24 or 32 Volt System, Order Replacement Bulb Cat. No. 432 000 24V or 432 000 32V.

## FIXED SPREADER LIGHT FIG. 265

Complete with 12 Volt, 6 C.P. Bulb

Chrome Plated Bronze



Fig. 265



ORDERING INFORMATION						
O.D. Inches	Depth Inches	Display Pkg.-5 cds. 1 Pc. per card	Std. Pkg.-5 pcs. OEM Pkg.-10 pcs.	Screw Size	Weight Ounces	
2¾	1⅝	265 DP CHR	265 000 CHR	6	5	

Spare Bulbs (2 per bag), Cat. No. 70 DP0 CLR.

Spare Socket Assembly, Cat. No. 265 000 99A.

Spare Lens with O-Ring, Cat. No. 284 DP CLR.

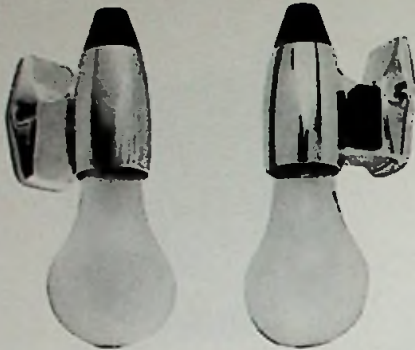
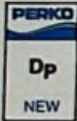

Fig. 217

Fig. 1295



## BULKHEAD LIGHT FIXTURE

FIGS. 217 & 1295

For Systems up to 50 Volts  
Medium Screw Socket, Turn Switch

Fig. 1295 has a Power Take-Off Receptacle  
Bulb Not Included

Chrome Plated Zinc

### ORDERING INFORMATION

Size Base Inches	Projection Less Lamp Inches	Display Pkg.-5 pcs. 1 Pc. per card	Standard Pkg.-5 pcs.	Screw Size	Weight Ounces
2½ x 1¾	2⅝	217 DP CHR	217 000 CHR	6 R.H.	8
2½ x 1¾	2⅝	1295 DP CHR	1295 000 CHR	6 R.H.	9

Spare Bulb Socket with Knob, Cat. No. 223.



Fig. 450

## BULKHEAD LIGHT FIXTURE

FIG. 450

For Systems up to 50 Volts  
Medium Screw Socket, Turn Switch  
Bulb Not Included

Cast Bronze  
Polished or Chrome Plated

### ORDERING INFORMATION

Dimensions Base Inches	Projection Less Lamp Inches	Polished Bronze Display Pkg.-5 pcs.	Chrome Plated Bronze Display Pkg.-5 pcs.	Polished Bronze Std. Pkg.-5 pcs.	Chrome Plated Bronze Std. Pkg.-5 pcs.	Screw Size	Weight Ounces
2½ x 2¼	2½	450 DP POL	450 DP CHR	450 000 POL	450 000 CHR	8 R.H.	11

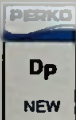

Spare Bulb Socket with Knob, Cat. No. 223.



Fig. 1303

## BULKHEAD LIGHT FIXTURE

FIG. 1303

For Systems up to 50 Volts

Size No. 1 has Double Contact Bayonet Socket.  
Will accommodate bulbs up to 32 C.P.

Size No. 2 has Medium Screw Socket.  
Will accommodate bulbs up to 40 watts.  
Bulb Not Included

Molded Plastic, Black or White

### ORDERING INFORMATION

Dimensions Wall Plate Inches	Normal Projection Inches	Length Shade Inches	Black Std. Pkg.-1 pc. OEM Pkg.-50 pcs.	White Std. Pkg.-1 pc. OEM Pkg.-50 pcs.	Screw Size	Weight Ounces
4½ x 3¼	4⅝	3	1303 001 BLK	1303 001 WHT	8	3
4½ x 3¼	5	4½	1303 002 BLK	1303 002 WHT	8	5

Spare Switch, Cat. No. 701 DP.



**U.S.C.G. ELECTRICAL STANDARDS**

**JANUARY 31, 1977 THE U.S.C.G. PUBLISHED SAFETY STANDARDS FOR MARINE ELECTRICAL SYSTEMS. THESE STANDARDS COVER SUCH TECHNICAL DETAILS AS:**

**CONDUCTOR SIZE AND AMPACITY**

**STRAIN RELIEF AND PULL TESTS**

**TERMINATION REQUIREMENTS**

**OVERCURRENT PROTECTION**

**IGNITION PROTECTION**

**BATTERIES AND ASSOCIATED CONDUCTORS**

**GROUNDING**

**INSULATION**

A particular electrical component may be affected by some or all of the above categories. Those categories related to product design have been complied with, however, many additional details must be considered by the installer of the equipment as well in order to achieve compliance with this standard. It is suggested that the actual standard be familiarized when installing equipment. Perhaps one of the most critical requirements is ignition protection. A product that is marked "Ignition Protected" can be used in that area of a boat that is not isolated from a gasoline fuel vapor source. Refer to the actual standard for a determination of what parts of a boat require Ignition Protected products. If a product is not plainly marked "Ignition Protected" then assume it is not.

**FOR DETAILS ON ALL OF THE ABOVE, OBTAIN THE FOLLOWING:  
U.S.C.G. SAFETY STANDARDS FOR ELECTRICAL SYSTEMS  
CFR TITLE 33, CHAPTER 1, SUBCHAPTER S, PART 183, SUBPART I.**

## BATTERY SELECTOR SWITCHES

### IGNITION PROTECTED

STANDARD FEATURES INCLUDE A MAKE BEFORE BREAK DESIGN, FOR USE WITH TWO OR MORE BATTERIES AND SINGLE OR DUAL ENGINE SYSTEMS\*. THEY PERMIT SELECTION BETWEEN BATTERIES FOR STARTING AND CHARGING OR OPERATION OF BOTH BATTERIES IN PARALLEL. THEY ALLOW THE ADDITION OF AN EXTRA BATTERY FOR USE WITH ACCESSORIES. THE "OFF" POSITION ALSO ACTS AS AN EMERGENCY DISCONNECT IN THE EVENT OF AN ELECTRICAL PROBLEM. IN ADDITION SOME MODELS OFFER UNIQUE OPTIONS SUCH AS A KEYLOCK FOR EXTRA THEFT PROTECTION.

*Protected by the following U.S. Patents; Design 260,637 - 4,280,028 - 4,424,424*

Surface Mount, Red Plastic Housing with Large Black Plastic Knob. Incorporates an improved design to protect the copper contacts and brass terminals used as electrical connections.

For use with systems under 50 volts. Capacity — 250 AMPS Continuous, 360 AMPS Intermittent.

#### ORDERING INFORMATION

Features:	Display Pkg.-5 pkgs. 1 Pc. per pkg.	Standard Pkg.-5 pcs. OEM Pkg.-25 pcs.	Diameter Inches	Depth Inches	Weight Pounds
Standard	8501 DP	8501	5¼	2⅝	1
with Keylock	8502 DP	8502	5¼	2⅝	1



Fig. 8501



Fig. 8502



\*For Dual Engine Systems, two switches are required.

## ALTERNATOR FIELD DISCONNECT MODELS

In addition to the standard features listed above the advantage these models feature is that they will prevent damage to the alternator\* if accidentally switched to the "OFF" position while the engine is running.

#### ORDERING INFORMATION

Features:	Display Pkg.-5 pkgs. 1 Pc. per pkg.	Standard Pkg.-5 pcs. OEM Pkg.-25 pcs.	Diameter Inches	Depth Inches	Weight Pounds
Standard	8503 DP	8503	5¼	2⅝	1
with Keylock	8504 DP	8504	5¼	2⅝	1



Fig. 8503



Fig. 8504



\*When used with Non-Unitized Alternators, these models will interrupt the field current (reducing the possibility of damage) if turned "OFF" with the engine running.



## MAIN BATTERY SWITCHES

### IGNITION PROTECTED

These units are the same basic design and construction as our 8500 Series, except they are offered as main disconnect switches.

For use with systems under 50 volts.  
Capacity — 250 AMPS Continuous, 360 AMPS Intermittent.

Protected by the following U.S. Patents; Design 260,637 - 4,280,028 - 4,424,424

#### ORDERING INFORMATION

Features:	Display Pkg.-5 pkgs. 1 Pc. per pkg.	Standard Pkg.-5 pcs. OEM Pkg.-25 pcs.	Diameter Inches	Depth Inches	Weight Pounds
Standard	9601 DP	9601	5¼	2⅝	1
with Keylock	9602 DP	9602	5¼	2⅝	1



Fig. 9601



Fig. 9602



## ALTERNATOR FIELD DISCONNECT MODELS

In addition to the standard features the advantage these models feature is that they will prevent damage to the alternator\* if accidentally switched to the "OFF" position while the engine is running.

#### ORDERING INFORMATION

Features:	Display Pkg.-5 pkgs. 1 Pc. per pkg.	Standard Pkg.-5 pcs. OEM Pkg.-25 pcs.	Diameter Inches	Depth Inches	Weight Pounds
Standard	9603 DP	9603	5¼	2⅝	1
with Keylock	9604 DP	9604	5¼	2⅝	1



Fig. 9603



Fig. 9604



\*When used with Non-Unitized Alternators, these models will interrupt the field current (reducing the possibility of damage) if turned "OFF" with the engine running.

## BATTERY SELECTOR SWITCHES WITH REMOTE INDICATOR PANEL

### IGNITION PROTECTED

These units have the same basic features and construction as Figs. 8501 & 8502 plus provisions for use with a remote indicator panel.

For use with systems under 50 volts.  
Indicator panel supplied with 12 volt lamps only.  
Capacity — 250 AMPS Continuous, 360 AMPS Intermittent.

Protected by the following U.S. Patents; Design 260,367 - 4,280,028 - 4,424,424

#### ORDERING INFORMATION

Features:	Display Pkg.-5 pkgs. 1 Pc. per pkg.	Standard Pkg.-5 pcs. OEM Pkg.-25 pcs.	Diameter Inches	Depth Inches	Weight Pounds
Standard	8505 DP	8505	5¼	2⅝	1
with Keylock	8506 DP	8506	5¼	2⅝	1

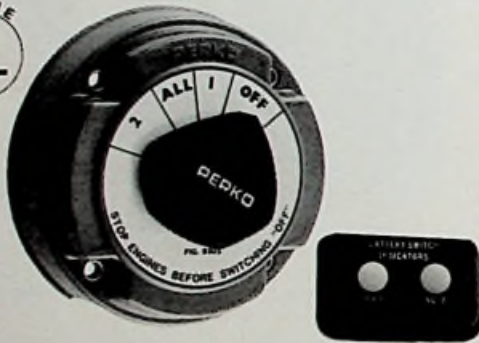

Fig. 8505

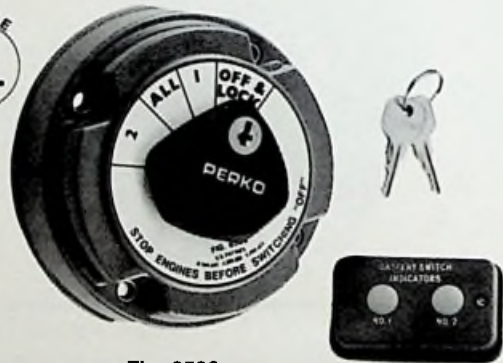

Fig. 8506



These Switches are Designed to Meet Federal Specification-Ambulance (KKK-A-1822B).

### IGNITION STARTER SWITCH FIG. 310

3 Position: Off-Ign/Run-Start. Rated for 15 Amps at 12 Volts.  
Automatically returns from start to run position.

Chrome Plated Brass Face Nut with Plain Brass Body

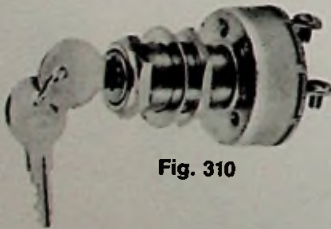

Fig. 310

#### ORDERING INFORMATION

For Dash Thickness Inches	Diameter Neck Inches	Length Overall Inches	Display Pkg.-10 cds. 1 Pc. per card	Standard Pkg.-10 pcs.	Weight Ounces
1	13/16	2¾	310 DP CHR	310 000 CHR	4½

Note: This Item Is Not Ignition Protected.



## PUSH-PULL SWITCHES FIG. 105

**2 Position: Off-On. Rated for 15 Amps at 12 Volts**

**Chrome Plated Brass Face Nut and Plastic Knob  
with Plain Brass Body**

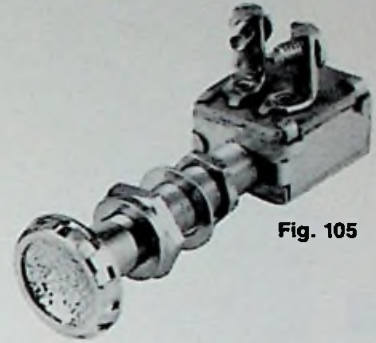

Fig. 105

### ORDERING INFORMATION

For Dash Thickness Inches	Diameter Neck Inches	Length Overall Inches	Display Pkg.-10 cds. 1 Pc. per card	Std. Pkg.-10 pcs. OEM Pkg.-50 pcs.	Weight Ounces
1	3/8	3	105 DP1 CHR	105 001 CHR	2 1/2



## PUSH-PULL SWITCH FIG. 366

**3 Position: 2 Circuit, Off-On-On. Rated for 15 Amps at 12 Volts**

For use with Combination Masthead/All-Round Lights together with running lights. Second "On" Position turns off running lights and turns on both compartments of Masthead/All-Round Light.

**Chrome Plated Brass Face Nut and Plastic Knob  
with Plain Brass Body**

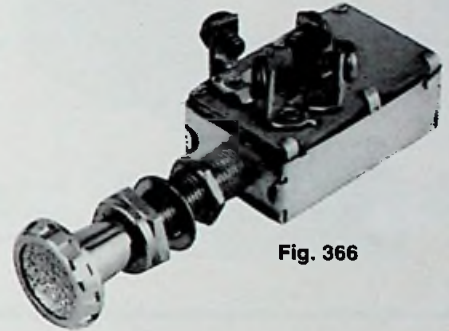

Fig. 366

### ORDERING INFORMATION

For Dash Thickness Inches	Diameter Neck Inches	Length Overall Inches	Display Pkg.-10 cds. 1 Pc. per card	Standard Pkg.-10 pcs.	Weight Ounces
1	3/8	3 3/4	366 DP CHR	366 000 CHR	3 1/4



## PUSH-PULL SWITCH FIG. 381

**3 Position: Off-On-On. Rated for 15 Amps at 12 Volts**

First "On" Position Energizes One Terminal  
Second "On" Position Energizes Both Terminals

**Chrome Plated Brass Face Nut and Plastic Knob  
with Plain Brass Body**

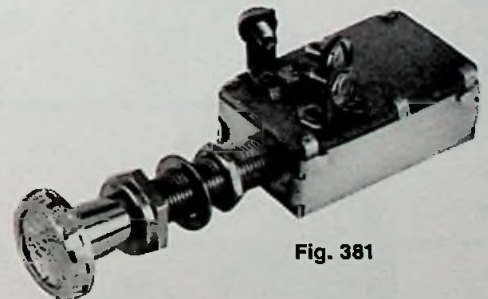

Fig. 381

### ORDERING INFORMATION

For Dash Thickness Inches	Diameter Neck Inches	Length Overall Inches	Display Pkg.-10 cds. 1 Pc. per card	Standard Pkg.-10 pcs.	Weight Ounces
1	3/8	3 3/4	381 DP CHR	381 000 CHR	3 1/4



**Important Note: None of the above Switches are Ignition Protected. See Page 75.**

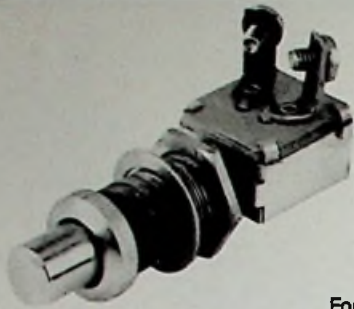

## MOMENTARY SWITCH FIG. 255

Single Pole  
Rated for 15 Amps at 12 Volts

Chrome Plated Brass Button and Face Nut  
with Plain Brass Body

### ORDERING INFORMATION

PERKO Dp	Fig. 255	For Dash Thickness Inches	Diameter Neck Inches	Length Overall Inches	Display Pkg.-10 cds. 1 Pc. per card	Std. Pkg.-10 pcs. OEM Pkg.-50 pcs.	Weight Ounces
		1	5/8	2 3/4	255 DP CHR	255 000 CHR	2 1/2



## MOMENTARY SWITCH FIG. 306

Single Pole  
Rated for 15 Amps at 12 Volts

Chrome Plated Brass Button with Plain Brass Body  
and Weather Resistant Neoprene Cover Over Button

### ORDERING INFORMATION

PERKO Dp NEW	Fig. 306	For Dash Thickness Inches	Diameter Neck Inches	Length Overall Inches	Display Pkg.-10 cds. 1 Pc. per card	Std. Pkg.-10 pcs. OEM Pkg.-50 pcs.	Weight Ounces
		1	5/8	2 3/4	306 DP CHR	306 000 CHR	3



## PUSH BUTTON SWITCH FIG. 701

Push-On, Push-Off  
Rated for 2 Amps at 12 Volts

Black Plastic with Weather Resistant Cover

### ORDERING INFORMATION

PERKO Dp NEW	Fig. 701	Maximum Thickness of Panel Inches	Diameter Neck Inches	Display Pkg.-10 bags 1 Pc. per bag	Weight Ounces
		1/8	3/8	701 DP	1/2



## PUSH BUTTON SWITCH FIG. 703

Push-On, Push-Off  
Rated for 2 Amps at 12 Volts

Nickel Plated Button  
with Brushed Aluminum Face Nut

### ORDERING INFORMATION

PERKO Dp	Fig. 703	Maximum Thickness of Panel Inches	Diameter Neck Inches	Display Pkg.-10 bags 1 Pc. per bag	Weight Ounces
		1/8	3/8	703 DP NKL	1/2

**Important Note: None of the above Switches are Ignition Protected. See Page 75.**

## SWITCH PANELS FIGS. 517 & 517A

**BLACK PLASTIC**

Rated for 15 Amps at 12 Volts. For 1/4" x 1 1/4" Fuses.  
Complete with Switches, Name Plates  
and Fuse Holders for 1/4" x 1 1/4" Fuses.

Will Mount on Curved or Flat Surfaces, Textured Finish,  
Engraved Lettering

If Name Plates Other Than Those Shown Are Desired  
Specify Fig. 517A and Names Required. See Fig. 519.

### ORDERING INFORMATION

Dimensions Inches	Display Pkg.-5 boxes 1 Pc. per box	Std. Pkg.-1 pc. OEM Pkg.-50 pcs.	Standard Pkg.-1 pc.	Weight Ounces
6 1/2 x 4 1/2	517 DP BLK	517 000 BLK	517 A00 BLK	8

Screw Size #6

Spare Switches, Cat. No. 514 DP.

Spare Fuse Holder Cap, Cat. No. 522 DP.

Spare Fuse Holders, Cat. No. 516 DP.

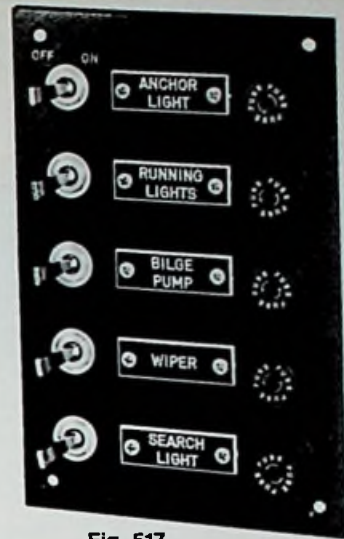

Fig. 517



## SWITCH PANEL NAME PLATES FIG. 519

**Black Plastic With Engraved White Lettering**

### ORDERING INFORMATION

For the ordering number insert number of plate needed from the list below, in the  
space provided between the "519" and "BLK" (i.e., 519 001 BLK Anchor Light).

Length Inches	Width Inches	Standard Pkg.-5 pcs.	Screw Size	Weight Per Std. Pkg. Ounces
1 1/2	1/2	519 ___ BLK	4	1/4

No.	No.	No.	No.
001. Anchor Light	004. Blower	035. Running Lights	044. Wiper
003. Bilge Pump	019. Horn	036. Searchlight	045. 12 Volt
			047. 110V AC



Fig. 519



Special name plates are available (Min. 50 pcs. per Name), price upon request.

## TOGGLE SWITCH FIG. 514

Single Pole, Single Throw (Off-On). Rated for 6 Amps at 12 Volts  
Nickel Plated Brass Toggle with Chrome Plated Face Nut

ORDERING INFORMATION			
Maximum Thickness of Panel Inches	Diameter Neck Inches	Display Pkg.-10 bags 1 Pc. per bag	Weight Ounces
5/16	7/16	514 DP	3/4



Fig. 514



## TOGGLE SWITCH FIG. 688

Single Pole, Single Throw (Off-On). Rated for 15 Amps at 12 Volts.  
Nickel Plated Brass Toggle with Chrome Plated Face Nut

ORDERING INFORMATION			
Maximum Thickness of Panel Inches	Diameter Neck Inches	Display Pkg.-10 bags 1 Pc. per bag	Weight Ounces
3/16	7/16	688 DP NKL	1

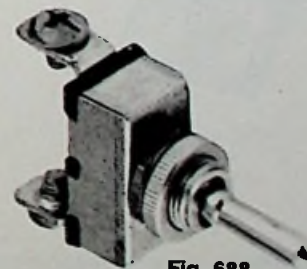
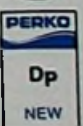

Fig. 688



**Important Note: None of the above Switches are Ignition Protected. See Page 75.**

## FUSE PANELS FIG. 626



Fig. 626

Rated for 20 Amps at 12 Volts  
For 1/4" x 1 1/4" Fuses

Molded Plastic Base with Brass Hardware

### ORDERING INFORMATION

Number of Gangs	Display Pkg.-5 bags 1 Pc. per bag	Standard Pkg.-5 pcs.	Dimensions Inches	Weight Ounces
3	626 003 DP	626 003	2 1/4 x 2 7/16 x 3/16	2
4	626 004 DP	626 004	3 x 2 7/16 x 3/16	2 1/4
5	626 005 DP	626 005	3 3/4 x 2 7/16 x 3/16	2 1/2
6	626 006 DP	626 006	4 1/2 x 2 7/16 x 3/16	2 3/4

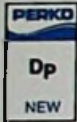

## FUSE PANELS FIG. 629

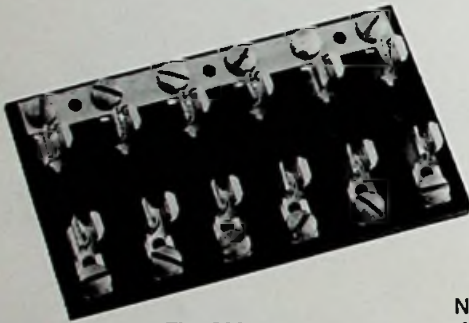

Fig. 629

Rated for 20 Amps at 12 Volts  
For 1/4" x 1 1/4" Fuses

Single Bus Bar  
Molded Plastic Base with Brass Hardware

### ORDERING INFORMATION

Number of Gangs	Display Pkg.-5 bags 1 Pc. per bag	Standard Pkg.-5 pcs.	Dimensions Inches	OEM Package	Weight Ounces
4	629 004DP	629 004	3 x 2 7/16 x 3/16	50	2
6	629 006 DP	629 006	4 1/2 x 2 7/16 x 3/16	—	3
8	629 008 DP	629 008	6 x 2 7/16 x 3/16	50	3
12	629 012 DP	629 012	9 x 2 7/16 x 3/16	25	6 1/2



## FUSE PANEL FIG. 694



Fig. 694

Rated for 20 Amps at 12 Volts  
For 1/4" x 1 1/4" Fuses

Includes Center Clip for Spare Fuse.  
Molded Plastic Base with Brass Hardware

### ORDERING INFORMATION

Number of Gangs	Display Pkg.-5 bags 1 Pc. per bag	Std. Pkg.-5 pcs. OEM Pkg.-50 pcs.	Dimensions Inches	Weight Ounces
2	694 DP	694	2 7/16 x 1 1/2 x 3/16	1 1/2

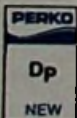

**Important Note: All of the Above Items Conform to U.S.C.G. Electrical Standards. See Page 75.**



## COMBINATION FUSE & TERMINAL BLOCK FIG. 647

Rated for 20 Amps at 12 Volts  
For 1/4" x 1 1/4" Fuses

Heavy Duty Binding Posts  
Molded Plastic Base with Brass Hardware



Fig. 647

### ORDERING INFORMATION

Number of Gangs	Display Pkg.-5 bags 1 Pc. per bag	Standard Pkg.-5 pcs.	Dimensions Inches	OEM Package	Weight Ounces
4	647 004 DP	647 004	3 x 3 5/16 x 3/16	50	3 1/2
6	647 006 DP	647 006	4 1/2 x 3 5/16 x 3/16	50	5
8	647 008 DP	647 008	6 x 3 5/16 x 3/16	---	7
12	647 012 DP	647 012	9 x 3 5/16 x 3/16	---	11



## TERMINAL BLOCKS FIG. 627

Rated for 30 Amps at 12 Volts

Molded Plastic Base with Brass Hardware



Fig. 627

### ORDERING INFORMATION

Number of Gangs	Display Pkg.-5 bags 1 Pc. per bag	Std. Pkg.-5 pcs. OEM Pkg.-50 pcs.	Dimensions Inches	Weight Ounces
2	627 002 DP	627 002	1 1/2 x 1 1/2 x 3/16	1
4	627 004 DP	*627 004	3 x 1 1/2 x 3/16	2
6	627 006 DP	627 006	4 1/2 x 1 1/2 x 3/16	2 1/4

\*No OEM Package Available



## IN-LINE FUSEHOLDER FIG. 786

Rated for 20 Amps at 12 Volts  
For 1/4" x 1 1/4" Fuses

Complete with 12 Volt, 20 Amp Fuse  
and 7 1/2 Inch Wire Lead.



Fig. 786

Molded Plastic

### ORDERING INFORMATION

Length Inches	Diameter Inches	Display Pkg.-10 bags 1 Pc. per bag	OEM Pkg.-50 pcs.	Weight Ounces
2 1/8	1 1/16	786 DP	786	3/4



**Important Note: All of the Above Items Conform to U.S.C.G. Electrical Standards. See Page 75.**

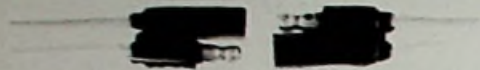

Fig. 720-2

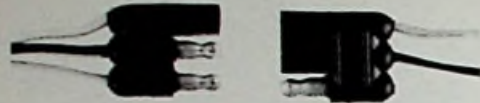

Fig. 720-3

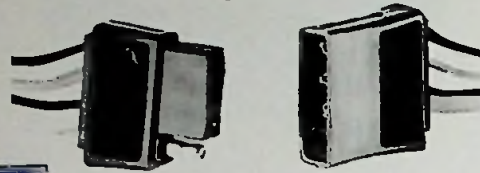

Fig. 720-4 — Shrouded

## FLAT LINE CONNECTORS FIG. 720

Rated for 15 Amps at 12 Volts  
Polarized

Both Sides Have 12 Inch, 18 Gauge Color Coded Wire Leads.

Molded Plastic Bodies with Brass Contacts

### ORDERING INFORMATION

Number of Poles	Display Pkg.-5 bags 1 Pc. per bag	Standard Pkg.-5 pcs.	Width Inches	Weight Ounces
2	720 DP2	720 002	5/8	1
3	720 DP3	720 003	7/8	1½
4	*720 DP4	*720 004	1 1/8	2

\*All contacts are shrouded.



Fig. 1189 — Chrome Plated Brass  
Fig. 1190 — Chrome Plated Zinc

## WATERTIGHT DECK CONNECTIONS FIGS. 1189 & 1190

Rated for 15 Amps at 12 Volts  
Polarized Double Contact Connector

Fig. 1189, Chrome Plated Brass  
Fig. 1190, Chrome Plated Zinc

Flange Gasket with Integral Waterproof Cap  
For Base When Plug is Removed.

### ORDERING INFORMATION

Diameter Inches	Height Inches	Display Pkg.-10 bags 1 Pc. per bag	Std. Pkg.-10 pcs. OEM Pkg.-50 pcs.	Screw Size	Weight Ounces
1 5/8	1 3/16	1189 DP CHR	1189 000 CHR	4	2 1/2
1 5/8	1 3/16	1190 DP CHR	1190 000 CHR	4	2 1/2

Spare Connector with Cover, Cat. No. 1189 DP 99A.

Spare Connector Only, Cat. No. 42.

**Note: These Items Are Not Ignition Protected.**



**Important Note: All of the Above Items Conform to U.S.C.G. Electrical Standards. See Page 75.**



Fig. 424 — Chrome Plated Brass  
Fig. 1191 — Chrome Plated Zinc

## WATERTIGHT CABLE OUTLETS FIGS. 424 & 1191

For 5/16 Inch O.D. Cable

Fig. 424, Chrome Plated Brass  
Fig. 1191, Chrome Plated Zinc

Equipped with Rubber Grommet  
for Watertight Passage of Cable.

### ORDERING INFORMATION

Diameter Base Inches	Display Pkg.-10 bags 1 Pc. per bag	Standard Pkg.-10 pcs.	Screw Size	Weight Ounces
1 1/4	424 DP CHR	424 000 CHR	4	1
1 1/4	1191 DP CHR	1191 000 CHR	4	1



## BRASS CABLE STRAPS FIG. 121

For Cable, Tubing, Control Wire, Etc.

### ORDERING INFORMATION

I.D. Inches	Length Inches	Display Pkg.-10 bags 10 Pcs. per bag
1/8	1 7/16	121 DP1 PLB
3/16	1 3/8	121 DP2 PLB
1/4	1 5/16	121 DP3 PLB
5/16	1 3/16	121 DP4 PLB
3/8	1 5/8	121 DP5 PLB
7/16	1 5/8	121 DP6 PLB
1/2	1 1/2	121 DP7 PLB
5/8	1 3/4	121 DP8 PLB
3/4	1 7/8	121 DP9 PLB



Fig. 121

Width all sizes — 1/2 inch.

Note: This Item Conforms to U.S.C.G. Fuel Standards.



## PLASTIC CABLE STRAPS FIG. 196

Black Plastic, Ultra-Violet Stabilized for Weather Resistance. Eliminates the Need for Insulating Cushion.

### ORDERING INFORMATION

I.D. Inches	Display Pkg.-10 bags 10 Pcs. per bag	OEM Pkg.-500 pcs.
3/16	196 DP1	196 001
1/4	196 DP2	196 002
5/16	196 DP3	196 003
3/8	196 DP4	196 004
1/2	196 DP5	196 005
5/8	196 DP6	196 006
3/4	196 DP7	196 007



Fig. 196

Width All Sizes — 1/2 inch.

NOTE: This Item Conforms to U.S.C.G. Electrical Standards.



## LINE SUPPORT CLIPS FIGS. 163, 164 & 165

Aluminum with Synthetic Rubber Cushion

### ORDERING INFORMATION

For O.D. Line Inches	Width Inches	ORDERING INFORMATION		
		Single Display Pkg.-10 bags 10 Pcs. per bag	Double Display Pkg.-10 bags 10 Pcs. per bag	Triple Display Pkg.-10 bags 10 Pcs. per bag
3/16	3/8	163 DP1 ALU	164 DP1 ALU	_____
1/4	3/8	163 DP2 ALU	164 DP2 ALU	_____
5/16	1/2	163 DP3 ALU*	164 DP3 ALU	165 DP3 ALU
3/8	1/2	163 DP4 ALU*	164 DP4 ALU	165 DP4 ALU
1/2	1/2	163 DP5 ALU	164 DP5 ALU*	165 DP5 ALU*
5/8	1/2	163 DP6 ALU*	_____	_____



Fig. 163  
Single

Fig. 164  
Double

Fig. 165  
Triple

\*OEM Package -500 pcs. Replace "DP" With "00" When Ordering.

Note: This Item Conforms to U.S.C.G. Electrical and Fuel Standards.

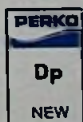

## DOUBLE CONTACT BAYONET BASE BULBS

FIG. 337

CLEAR



Fig. 337

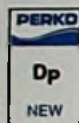

Nominal Voltage	Candle Power	Amps	ORDERING INFORMATION		Bulb Diameter Inches	Mfr. Lamp No.
			Standard Pkg.-10 pcs.	Display Pkg.-5 bags 2 Pcs. per bag		
12	6	.58	-----	337 011 DP	3/4	90
12	15	.94	-----	337 012 DP	3/4	1004
12	21	1.44	-----	337 013 DP	1	1142
32	9	.37	337 018 CLR	-----	3/4	624
32	15	.45	337 019 CLR	-----	1	1228
32	21	.61	337 020 CLR	-----	1	1692
32	32	.74	337 021 CLR	-----	1 3/8	1054
120	15W	—	-----	337 023 DP	7/8	15T7

## DOUBLE ENDED BULBS

FIG. 70

CLEAR

Rust-Proof Nickel Plated Brass Caps

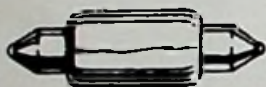

Fig. 70



Nominal Voltage	Candle Power	Amps	ORDERING INFORMATION		Bulb Diameter Inches	Bulb Length Inches
			Display Pkg.-5 bags 2 Pcs. per bag	OEM Pkg.-100 pcs.		
12	6	.74	70 DP0 CLR	70 000 CLR	9/16	1 1/16
12	12	.97	70 DP1 CLR	70 001 CLR	9/16	1 1/16
32	12	.40	70 DP2 CLR	70 002 CLR	3/8	1 5/8

## MEDIUM SCREW BASE BULBS

FIG. 340

FROSTED

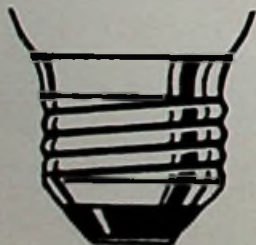

Fig. 340



Nominal Voltage	Wattage	ORDERING INFORMATION			Mfg. Lamp No.
		Standard Pkg.-6 pcs.	Type	L.C.L. Inches	
12	15	340 005 FRD	A-17	2 3/8	15-A
12	25	340 006 FRD	A-19	2 9/16	25-A
12	50	340 007 FRD	A-21	3 7/16	50-A21
32	15	340 011 FRD	A-17	2 3/8	15-A
32	25	*340 012 FRD	A-19	2 9/16	25-A
32	50	*340 013 FRD	A-21	3 7/16	50-A21

\*Standard package — 2 pcs.

**NOTE: High Power Bulbs and Sealed Beam Units for Searchlights, See Searchlight Section.  
ELECTRIC BULBS ARE NOT RETURNABLE. ORDER CAREFULLY.**

## CHROMALEX® COWL VENTILATOR FIG. 1312

Chrome Plated Zinc Cowl with Black Plastic Base

3 Inch Duct Threads into Neck, Hose Clamps Not Required

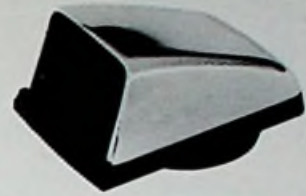

Fig. 1312

Mouth Opening Square Inches	Length Overall Inches	Width Overall Inches	Height Overall Inches	ORDERING INFORMATION			
				Display Pkg.-5 cds. 1 Pc. per card	Std. Pkg.-5 boxes 1 Pc. per box	OEM Pkg.	Weight Ounces
7	5 $\frac{1}{4}$	4 $\frac{3}{8}$	2 $\frac{5}{8}$	1312 DP CHR	1312 000 CHR	50	12

Screw Size #8.



## COWL VENTILATOR FIG. 870

Chrome Plated Zinc

3 Inch Duct Threads into Neck, Hose Clamps Not Required

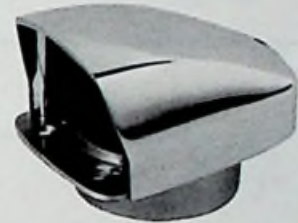

Fig. 870

Mouth Opening Square Inches	Length Overall Inches	Width Overall Inches	Height Overall Inches	ORDERING INFORMATION	
				Standard Pkg.-5 pcs.	Weight Ounces
7	5 $\frac{1}{4}$	4	2 $\frac{3}{4}$	870 000 CHR	21

Screw Size #10.

## COWL VENTILATOR FIG. 510

Polished or Chrome Plated Brass  
Cast Bronze Deck Plate

Internal thumb screw allows cowl to be locked in any position.  
Ventilators are painted white inside only.

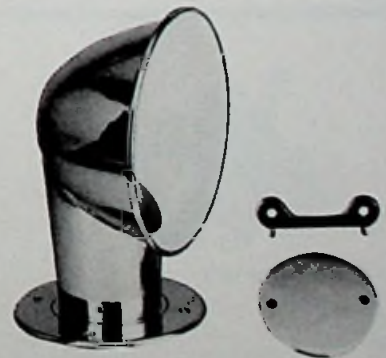

Fig. 510

Deck Plate Size Inches	Diam. Mouth Inches	Height Overall Inches	ORDERING INFORMATION		Weight Pounds
			Polished Brass Standard Pkg.-1 pc.	Chrome Plated Brass Standard Pkg.-1 pc.	
4	8	11	510 004 POL	510 004 CHR	6 $\frac{3}{8}$
5	10	13	510 005 POL	510 005 CHR	9 $\frac{3}{8}$

Screw Size #10.



Fig. 315

## CLAM SHELL VENTILATOR FIG. 315

Chrome Plated Brass

### ORDERING INFORMATION

Dimensions Base Inches	Height Opening Inches	Width Opening Inches	Display Pkg.-10 bags 1 Pc. per bag	Std. Pkg.-10 pcs. OEM Pkg.-100 pcs.	Screw Size	Weight Ounces
1 5/8 x 1 1/2	7/16	7/8	315 DP1 CHR	315 001 CHR	4	1/2
2 x 2	9/16	1 1/8	315 DP2 CHR	315 002 CHR	6	1 1/4



Fig. 339

## CLAM SHELL VENTILATOR FIG. 339

Chrome Plated Brass

### ORDERING INFORMATION

Dimensions Base Inches	Height Opening Inches	Width Opening Inches	Display Pkg.-5 cds. 1 Pc. per card	Std. Pkg.-5 pcs. OEM Pkg.-25 pcs.	Screw Size	Weight Ounces
4 x 3 3/4	1 5/8	2 1/2	339 DP CHR	339 000 CHR	6	5 1/2



Fig. 505

## GAS TANK VENT FIG. 505

Chrome Plated Bronze

With Removable 30 Mesh, Monel Wire Screen Flame Arrester.

Designed to meet the requirements of the National Fire Protection Assn. Booklet No. 302, Section No. 323 on vent pipe outlets. The 1/2" N.P.T. is off center to create a water baffle.

### ORDERING INFORMATION

O.D. Flange Inches	O.D. Neck Inches	Length Neck Inches	Display Pkg.-5 bags 1 Pc. per bag	Std. Pkg.-5 pcs. OEM Pkg.-25 pcs.	Screw Size	Weight Ounces
2 1/2	1 3/16	1 1/2	505 DP CHR	505 000 CHR	8	6 1/2



Fig. 506

## GAS TANK VENT FIG. 506

Chrome Plated Zinc

With Black Plastic Splash Guard and  
Removable 30 Mesh, Monel Wire Screen Flame Arrester.

### ORDERING INFORMATION

Hose Size Inches	Max. Hull Thickness Inches	Display Pkg.-10 bags 1 Pc. per bag	Std. Pkg.-10 pcs. OEM Pkg.-50 pcs.	Weight Ounces
5/8	3/4	506 DP4 CHR	506 004 CHR	2 1/2

Spare Splash Guard, Cat. No. 518 000 BLK.



**NOTE: FIGS. 505 & 506 ABOVE ARE DESIGNED TO MEET THE REQUIREMENTS OF U.S.C.G. SAFETY STANDARDS JANUARY 31, 1977, FOR GASOLINE FUEL SYSTEMS.**

## GAS TANK VENT WITH SWIVEL ELBOW FIG. 561

**Chrome Plated Zinc Cap  
With Removable 30 Mesh, Monel Wire Screen Flame Arrester  
and Black Plastic Splash Guard.**

Design Allows Elbow to be Rotated to any Position.



Fig. 561

### ORDERING INFORMATION

Hose Size Inches	Max. Hull Thickness Inches	Display Pkg.-10 bags 1 Pc. per bag	Std. Pkg.-10 pcs. OEM Pkg.-50 pcs.	Weight Ounces
5/8	1	561 DP4 CHR	561 004 CHR	3 1/4



## GAS TANK VENT FIG. 509

**Chrome Plated Bronze  
With Removable 30 Mesh, Monel Wire Screen Flame Arrester.**



Fig. 509

### ORDERING INFORMATION

Hose Size Inches	Max. Hull Thickness Inches	Display Pkg.-5 bags 1 Pc. per bag	Std. Pkg.-5 pcs. OEM Pkg.-50 pcs.	Weight Ounces
5/8	3/4	509 DP4 CHR	509 004 CHR	4
3/4	5/8	509 DP5 CHR	509 005 CHR	6



## GAS TANK VENT FIG. 503

**Chrome Plated Bronze  
With Removable 30 Mesh, Monel Wire Screen Flame Arrester.**



Fig. 503

### ORDERING INFORMATION

Thread Size Inches	Max. Hull Thickness Inches	Display Pkg.-5 bags 1 Pc. per bag	Std. Pkg.-5 pcs. OEM Pkg.-50 pcs.	Weight Ounces
3/8	7/8	503 DP3 CHR	503 003 CHR	5 1/2
1/2	7/8	503 DP4 CHR	503 004 CHR	6



## GAS TANK VENT FIG. 515

**Chrome Plated Bronze  
With Removable 30 Mesh, Monel Wire Screen Flame Arrester.**



Fig. 515

### ORDERING INFORMATION

Thread Size Inches	Max. Hull Thickness Inches	Display Pkg.-5 bags 1 Pc. per bag	Std. Pkg.-5 pcs. OEM Pkg.-50 pcs.	Weight Ounces
3/8	5/8	515 DP3 CHR	515 003 CHR	3
1/2	5/8	515 DP4 CHR	515 004 CHR	4



**NOTE: ALL OF THE ABOVE VENTS ARE DESIGNED TO MEET THE REQUIREMENTS OF U.S.C.G. SAFETY STANDARDS JANUARY 31, 1977, FOR GASOLINE FUEL SYSTEMS.**

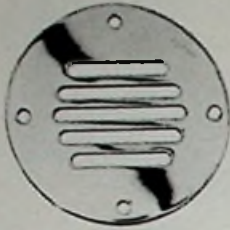

Fig. 330

## LOCKER VENTILATOR FIG. 330

Chrome Plated Brass

### ORDERING INFORMATION

O.D. Inches	Display Pkg.-10 bags 1 Pc. per bag	Std. Pkg.-10 pcs. OEM Pkg.-100 pcs.	Screw Size	Weight Ounces
2½	330 DP1 CHR	330 001 CHR	6 R.H.	¾
3¼	330 DP2 CHR	330 002 CHR	6 R.H.	1

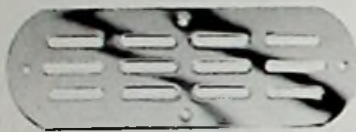

Fig. 550

## TRANSOM OR LOCKER VENTILATOR FIG. 550

Chrome Plated Brass

### ORDERING INFORMATION

Dimensions Inches	Display Pkg.-10 bags 1 Pc. per bag	Std. Pkg.-10 pcs. OEM Pkg.-25 pcs.	Screw Size	Weight Ounces
7 x 2½	550 DP CHR	550 000 CHR	8	3

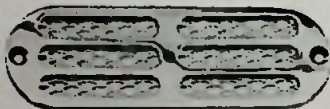

Fig. 1271

## TRANSOM OR LOCKER VENTILATOR FIG. 1271

Chrome Plated Zinc  
With Anodized Aluminum Grill Type Screen.

### ORDERING INFORMATION

Dimensions Inches	Display Pkg.-10 bags 1 Pc. per bag	Std. Pkg.-10 pcs. OEM Pkg.-25 pcs.	Screw Size	Weight Ounces
6 x 2	1271 DP CHR	1271 000 CHR	8	3



Fig. 1238

## TRANSOM OR LOCKER VENTILATOR FIG. 1238

Chrome Plated Zinc  
With Anodized Aluminum Grill Type Screen.

### ORDERING INFORMATION

Dimensions Inches	Display Pkg.-10 bags 1 Pc. per bag	Std. Pkg.-10 pcs. OEM Pkg.-50 pcs.	Screw Size	Weight Ounces
8¾ x 2¼	1238 DP CHR	1238 000 CHR	8	4

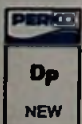



## LOUVER VENTILATOR FIG. 334

Chrome Plated Brass

### ORDERING INFORMATION

Dimensions Inches	Length Louvers Inches	Standard Pkg.-10 pcs.	Weight Ounces
3 x 2½	2	*334 002 CHR	1½
4 x 2½	3	334 02A CHR	1½
5½ x 2½	2	334 004 CHR	2½
7½ x 2½	3	334 04A CHR	3½
8 x 2½	2	334 006 CHR	3½
11 x 2½	3	334 06A CHR	4½

Screw Size #4 R.H.

\*O.E.M. Pkg. 25 pcs.

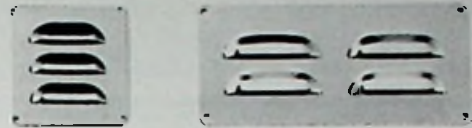

#2

#4

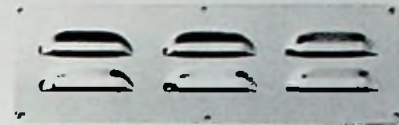

#6

Fig. 334

## LOUVER VENTILATOR FIG. 335

Chrome Plated Brass

### ORDERING INFORMATION

Dimensions Inches	Length Louvers Inches	Standard Pkg.-10 pcs.	Weight Ounces
3 x 3	2	335 003 CHR	1½
4 x 3½	3	335 03A CHR	2
5½ x 3	2	335 006 CHR	3
7½ x 3½	3	335 06A CHR	4½
8 x 3	2	335 009 CHR	4
11 x 3½	3	335 09A CHR	6½

Screw Size #4 R.H.



#3

#6

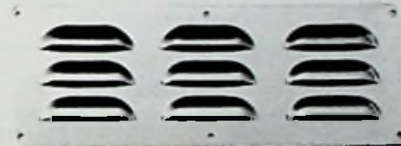

#9

Fig. 335

## LOUVER VENTILATOR FIG. 336

Chrome Plated Brass

### ORDERING INFORMATION

Dimensions Inches	Length Louvers Inches	Standard Pkg.-10 pcs.	OEM Package	Weight Ounces
3¾ x 3	2	336 004 CHR	—	2
4¾ x 4	3	336 04A CHR	25	3
4½ x 3	2	336 005 CHR	—	2½
5¾ x 4	3	336 05A CHR	—	3½
5¼ x 3	2	336 006 CHR	—	2½
6¾ x 4	3	336 06A CHR	25	4½

Screw Size #4 R.H.

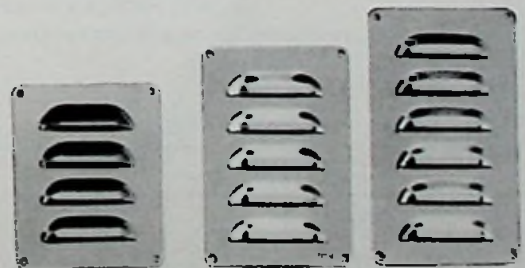

#4

#5

#6

Fig. 336

THE 8, 10, AND 12 INCH BELLS LISTED ON THIS PAGE HAVE BEEN REVIEWED BY THE U.S. COAST GUARD AND COMPLY WITH C.G. 169 REGULATIONS FOR SOUND SIGNAL APPLIANCES AS REQUIRED BY ANNEX III PARAGRAPH 2 OF THE 72 COLREGS. THE 8 AND 10 INCH SIZES ARE FOR USE ON VESSELS UNDER 20 METERS (65.6 FT.) IN LENGTH. THE 12 INCH SIZE IS FOR USE ON VESSELS OF ANY LENGTH.

## FOG BELL FIG. 420

Cast Bronze

Polished or Chrome Plated Bronze  
Medium Weight, Removable

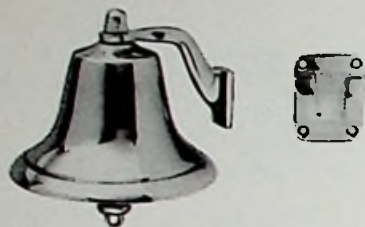

Fig. 420

### ORDERING INFORMATION

Bottom Diameter Inches	Height Overall Inches	Polished Bronze Std. Pkg.-1 pc.	Chrome Plated Bronze Std. Pkg.-1 pc.	Weight Pounds
6	5	420 006 POL	420 006 CHR	4¼
8	6½	420 008 POL	420 008 CHR	7½

Screw Size #8 F.H.

## FOG BELL FIG. 150

Cast Bronze

Plain, Polished, or Chrome Plated Bronze  
Heavy Weight, Removable



Fig. 150

### ORDERING INFORMATION

Bottom Diameter Inches	Height Overall Inches	Plain Bronze Std. Pkg.-1 pc.	Polished Bronze Std. Pkg.-1 pc.	Chrome Plated Bronze Std. Pkg.-1 pc.	Weight Pounds
8	8	150 008 PLB	150 008 POL	150 008 CHR	11
10	10½	150 010 PLB	150 010 POL	150 010 CHR	20½
12	12	150 012 PLB	150 012 POL	150 012 CHR	28¼

Screw Size ¼" F.H.

### SPARE PARTS ORDERING INFORMATION FOR PAGES 92 & 93.

FOR COMPLETE SPARE PART No. INSERT THE FINISH CODE: P or PLB, for Plain Bronze or Brass Finish (i.e. 420 P06 99A or 127 000 PLB)  
B or POL, for Polished Bronze or Brass Finish (i.e. 420 B06 99A or 127 000 POL)  
C or CHR, for Chrome Plated Finish (i.e. 420 C06 99A or 127 000 CHR)

#### ARMS

#### WALL PLATES

#### CLAPPERS

#### EYE BOLTS

#### ACORN NUTS

Figure No.	Spare Part No.	Figure No.	Spare Part No.	Figure No.	Spare Part No.	Figure No.	Spare Part No.	Figure No.	Spare Part No.
420-6"	420-99A-6"	420-6"	127	420-6"	153	420-6"	113	420-6"	465 004
420-8"	171	420-8"	127	420-8"	144	420-8"	123	420-8"	465 008
150-8"	171	150-8"	127	150-8"	144	150-8"	123	150-8"	465 008
150-10"	150-99A-10"	150-10"	150-99B-10"	150-10"	150-99C	*150-10"	150-99D	150-10"	465 009
150-12"	150-99A-12"	*150-12"	150-99B-12"	*150-12"	172	*150-12"	172	150-12"	465 009
*158-12"	158-99A-12"	*158-12"	158-99A-12"	*158-12"	172	*158-12"	172	158-12"	465 009
*158-14"	158-99A-14"	*158-14"	158-99A-14"	*158-14"	172	*158-14"	172	158-14"	465 009
179	179 000 99A	*179	179 000 99A	179	144	179	179-99B	179	465 008
159-6"	159-99A	159-6"	166	159-6"	159-99B	159-6"	113	159-6"	465 004
159-8"	159-99A	159-8"	166	159-8"	153	159-8"	113	159-8"	465 004

\*Includes Wall Bracket

\*Includes Arm

\*Includes Eye Bolt

\*Includes Clapper

THE 8 AND 12 INCH BELLS LISTED ON THIS PAGE HAVE BEEN REVIEWED BY THE U.S. COAST GUARD AND COMPLY WITH C.G. 169 REGULATIONS FOR SOUND SIGNAL APPLIANCES AS REQUIRED BY ANNEX III PARAGRAPH 2 OF THE 72 COLREGS. THE 8 INCH SIZE IS FOR USE ON VESSELS UNDER 20 METERS (65.6 FT.) IN LENGTH. THE 12 INCH SIZE IS FOR USE ON VESSELS OF ANY LENGTH.

## FOG BELL FIG. 158

**Cast Bronze**

Plain, Polished, or Chrome Plated Bronze  
Heavy Weight, Fixed Mounting



Fig. 158

### ORDERING INFORMATION

Bottom Diameter Inches	Height Overall Inches	Plain Bronze Std. Pkg.-1 pc.	Polished Bronze Std. Pkg.-1 pc.	Chrome Plated Bronze Std. Pkg.-1 pc.	Weight Pounds
12	12	158 012 PLB	158 012 POL	158 012 CHR	29 $\frac{3}{4}$

Bolt Size  $\frac{1}{4}$ " R.H.

## FOG BELL FIG. 179

**Wrought Brass**

Plain Brass  
Light Weight, Fixed Mounting



Fig. 179

### ORDERING INFORMATION

Bottom Diameter Inches	Height Overall Inches	Standard Pkg.-1 pc.	Weight Pounds
12	8	179 012 PLB	7 $\frac{3}{4}$

Screw Size #12 R.H.

## FOG BELL FIG. 159

**Stamped Brass**

Plain, Polished, or Chrome Plated Brass  
Light Weight, Removable



Fig. 159

### ORDERING INFORMATION

Bottom Diameter Inches	Height Overall Inches	Chrome Plated Display Pkg.-2 cds. 1 Pc. per card	Plain Brass Std. Pkg.-1 pc.	Polished Brass Std. Pkg.-1 pc.	Chrome Plated Brass Std. Pkg.-1 pc.	Weight Pounds
6	4	159 DP6 CHR	159 006 PLB	159 006 POL	159 006 CHR	1 $\frac{1}{2}$
8	5	-----	159 008 PLB	159 008 POL	159 008 CHR	2 $\frac{3}{4}$

Screw Size #4 R.H.



**NOTE: FIGS. 162 & 349 CONFORM TO A.B.Y.C. STANDARD A-23 IN ACCORDANCE WITH THE '72 COLREGS AND U.S. INLAND RULES FOR USE ON VESSELS UNDER 5 METERS (16.4 FT.) IN LENGTH.**



Fig. 162

## FOG HORN FIG. 162

**Aluminum with White Baked Enamel Finish  
Nylon Mouthpiece**

### ORDERING INFORMATION

Length Inches	Display Pkg.-5 bags 1 Pc. per bag	Standard Pkg.-5 pcs.	Weight Ounces
12½	162 DP WHT	162 000 WHT	6



Fig. 349

## "BALL TYPE" WHISTLE FIG. 349

**Orange Plastic**

### ORDERING INFORMATION

Length Inches	Width Inches	Display Pkg.-10 bags 1 Pc. per bag	OEM Pkg.-100 pcs.	Weight Ounces
2¼	¾	349 DP	349	1½



Fig. 441

## PORTLIGHT CHAIN FIG. 441

**Stainless Steel Chain with Chrome Plated Fittings**

### ORDERING INFORMATION

Length Inches	Length Strap Inches	Screw Size	Display Pkg.-5 bags 1 Pc per bag	Std. Pkg.-5 pcs. OEM Pkg.-50 pcs.	Weight Ounces
7	1⅞	8	441 DP CHR	441 000 CHR	2

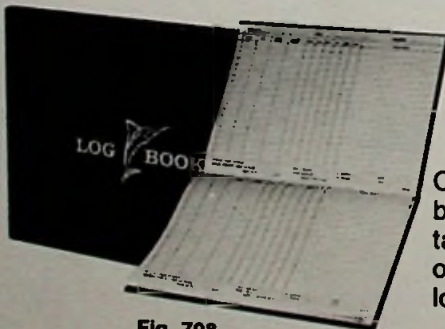
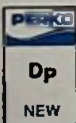

Fig. 708

## YACHT LOG BOOK FIG. 708

**112 Pages 8¼" x 11"**

Cover is hard plastic coated with a water resistant washable finish. Navy blue with gold lettering. In addition to pages for log data, these books contain useful information such as extracts from Bowditch Practical Navigator on symbols for weather, state of sea, cloud formations, force of wind, guest log and marine telephone log.

### ORDERING INFORMATION

Display Pkg.-5 bags 1 Pc. per bag	Weight Ounces
708 DP	18

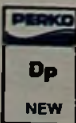

## INTAKE WATER STRAINERS FIGS. 493 & 500

### CAST BRONZE

PERKO WATER STRAINERS ARE DESIGNED FOR EASY INSTALLATION AND CLEANING. FEATURES INCLUDE MOUNTING LUGS CAST INTO BOTH SIDES TO ASSURE UNIVERSAL MOUNTING, FOUR OUTSIDE TIE RODS AND A 304 STAINLESS STEEL STRAINER BASKET TO MINIMIZE ELECTROLYSIS. HINGED LUGS FOR THE CAST BRONZE COVER PERMIT EASY REMOVAL AND CLEANING OF THE STRAINER BASKET. A DRAIN PLUG IN THE BOTTOM CASTING IS PROVIDED FOR EASILY REMOVING SEDIMENT AND DRAINING FOR WINTERIZING.

FOR APPLICATIONS REQUIRING HIGHER CAPACITY SEE FIG. 500 BELOW.



Fig. 493

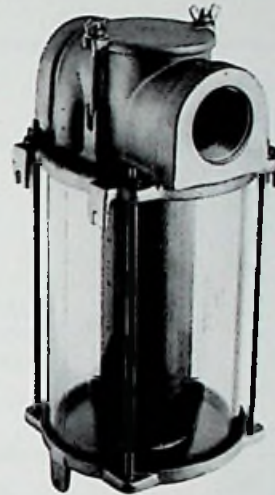

Fig. 500

#### ORDERING INFORMATION FIG. 493

Pipe Size Inches	Height Overall Inches	Width Overall Inches	Standard Pkg.-1 pc.	Dimensions Cylinder Inches	Dimensions Basket Inches	Open Area To Pipe Size Ratio	Weight Pounds
3/8	4 1/4	3 1/4	493 003 PLB	2 3/4 x 2 1/2	1 3/16 x 2 3/4	22:1	2 1/2
1/2	5 3/4	4 1/2	493 004 PLB	3 1/2 x 4	1 13/16 x 4 3/8	30:1	5
3/4	8 3/8	4 1/2	493 005 PLB	3 1/2 x 6	1 13/16 x 6 1/4	25:1	5
1	9 1/2	5 1/2	493 006 PLB	4 1/2 x 5 1/2	2 5/8 x 5 7/8	20:1	8
1 1/4	10	5 1/2	493 007 PLB	4 1/2 x 6	2 5/8 x 6 1/4	13:1	8
1 1/2	11 1/2	7 1/4	493 008 PLB	6 x 8	3 5/16 x 8 7/16	17:1	14
2	16	7 1/2	493 009 PLB	6 x 12	3 5/16 x 12 1/4	13:1	18
2 1/2	16	7 1/2	493 010 PLB	6 x 12	3 5/16 x 12 1/2	10:1	18

#### ORDERING INFORMATION FIG. 500

Pipe Size Inches	Height Overall Inches	Width Overall Inches	Standard Pkg.-1 pc.	Dimensions Cylinder Inches	Dimensions Basket Inches	Open Area To Pipe Size Ratio	Weight Pounds
2	14 1/2	9	500 009 PLB	8 x 10	3 7/8 x 10 1/4	20:1	34
2 1/2	16 1/2	9	500 010 PLB	8 x 12	3 7/8 x 12 1/4	18:1	34
3	18 1/2	9	500 011 PLB	8 x 14	3 7/8 x 14 1/4	14:1	34

#### SPARE PARTS ORDERING INFORMATION

For Spare Part No. Insert a Spare Part Code Listed Below in Place of the "PLB" in the Strainer's Catalog Number (i.e., 493 006 99A, Top Casting for 1" Strainer).

Top Casting	99A	Cover With Gasket	99E	Gasket Kit	99M	Cover Gaskets (2 per bag)	99N
Bottom Casting	99B	Hinged Bolt for Cover		Consists of:		Tie Rods, Nuts and Washers	99P
Transparent Cylinder Basket Strainer	99C 99D	With Pin, Nut And Washer	99L	1-Cover Gasket and 2-Cylinder Gaskets		Consists of:	
						(4 of Each for 493 Series) (1 of Each for 500 Series)	

## DECK PLATES FOR PIPE FIG. 528

**Cast Bronze  
Plain or Chrome Plated**

Complete with Fig. No. 1248 Key and O-Ring.  
1¼ and 1½ Inch Caps Have a Slot Between the Holes.



Fig. 528

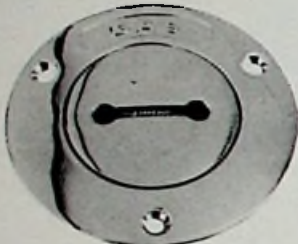

Fig. 528-G



Fig. 528-D



Fig. 528-W

### ORDERING INFORMATION For Unmarked Deck Plates

Pipe Size Inches	O.D. Flange Inches	Plain Bronze Std. Pkg.-1 pc.	Chrome Plated Bronze Std. Pkg.-1 pc.	Screw Size	Weight Ounces
1	27/8	528 006 PLB	528 006 CHR	8	12
1¼	35/16	528 007 PLB	528 007 CHR	8	12
1½	35/8	528 008 PLB	*528 008 CHR	8	16
2	4¼	528 009 PLB	528 009 CHR	8	33½
2½	45/8	528 010 PLB	528 010 CHR	10	33½
3	53/8	528 011 PLB	528 011 CHR	10	43½

### \*\*ORDERING INFORMATION For Gas Deck Plates

Pipe Size Inches	O.D. Flange Inches	Plain Bronze Std. Pkg.-1 pc.	Chrome Plated Bronze Std. Pkg.-1 pc.	Screw Size	Weight Ounces
1¼	35/16	528 G07 PLB	528 G07 CHR	8	12
1½	35/8	528 G08 PLB	*528 G08 CHR	8	16
2	4¼	528 G09 PLB	*528 G09 CHR	8	33½

### ORDERING INFORMATION For Diesel Deck Plates

Pipe Size Inches	O.D. Flange Inches	Plain Bronze Std. Pkg.-1 pc.	Chrome Plated Bronze Std. Pkg.-1 pc.	Screw Size	Weight Ounces
1¼	35/16	528 D07 PLB	528 D07 CHR	8	12
1½	35/8	528 D08 PLB	*528 D08 CHR	8	16
2	4¼	528 D09 PLB	528 D09 CHR	8	33½

### ORDERING INFORMATION For Water Deck Plates

Pipe Size Inches	O.D. Flange Inches	Plain Bronze Std. Pkg.-1 pc.	Chrome Plated Bronze Std. Pkg.-1 pc.	Screw Size	Weight Ounces
1¼	35/16	528 W07 PLB	*528 W07 CHR	8	12
1½	35/8	528 W08 PLB	*528 W08 CHR	8	16
2	4¼	528 W09 PLB	528 W09 CHR	8	33½

\*O.E.M. Pkg.-10 pcs.

\*\*NOTE: These Deck Plates Meet the Requirements of U.S.C.G. Safety Standards, January 31, 1977, for Gasoline Fuel Systems, 33CFR183.

### SPARE PARTS ORDERING INFORMATION

Pipe Size Inches	Plain Bronze Cap*	Chrome Plated Bronze Cap*	O-Rings Only (2 per bag)	Spare Key
1	528 P06 99A	528 C06 99A	513 006	1248 006 ZNC
1¼	528 P07 99A	528 C07 99A	513 007	1248 7-8 DP
1½	528 P08 99A	528 C08 99A	513 008	1248 7-8 DP
2	528 P09 99A	528 C09 99A	513 009	1248 009 ZNC
2½	528 P10 99A	528 C10 99A	513 010	1248 010 ZNC
3	528 P11 99A	528 C11 99A	513 011	528 011 99C

\*Complete With O-Ring.

## WASTE DECK PLATE FOR PIPE FIG. 524

### Chrome Plated Bronze

Complete with Fig. No. 1248 Key and O-Ring.  
Cap Has a Slot Between the Holes.

#### ORDERING INFORMATION

Pipe Size Inches	O.D. Flange Inches	Chrome Plated Bronze Std. Pkg.-1 pc.	OEM Pkg.	Screw Size	Weight Ounces
1½	3⅝	524 000 CHR	10	8	16

Spare Cap with O-Ring, Cat. No. 524 000 99A.  
Spare Key, Cat. No. 1248 7-8 DP.

Spare O-Rings Only (2 per bag), Cat. No. 513 008.



Fig. 524

## WASTE DECK PLATE FOR HOSE FIG. 507

### Chrome Plated Bronze

Complete with Fig. No. 1248 Key and O-Ring.  
Cap Has a Slot Between the Holes.

#### ORDERING INFORMATION

Hose Size Inches	O.D. Flange Inches	Length Neck Inches	Std. Pkg.-1 pc. OEM Pkg.-25 pcs.	Screw Size	Weight Ounces
1½	3⅝	3½	507 000 CHR	8	14

Spare Cap with O-Ring, Cat. No. 507 000 99A.  
Spare Key, Cat. No. 1248 7-8 DP.

Spare O-Rings Only (2 per bag), Cat. No. 513 008.



Fig. 507

## WASTE DECK PLATE FOR HOSE FIG. 508

### Chrome Plated Bronze Black Plastic Cap

Complete with Fig. No. 1248 Key and O-Ring.  
Cap Has a Slot Between the Holes.

#### ORDERING INFORMATION

Hose Size Inches	O.D. Flange Inches	Length Neck Inches	Std. Pkg.-1 pc. OEM Pkg.-25 pcs.	Screw Size	Weight Ounces
1½	3⅝	3½	508 000 CHR	8	11

Spare Cap with O-Ring, Cat. No. 508 000 99A.  
Spare Key, Cat. No. 1248 7-8 DP.

Spare O-Rings Only (2 per bag), Cat. No. 513 008.



Fig. 508

## WASTE DECK PLATE FOR HOSE FIG. 1269

### Chrome Plated Zinc Black Plastic Cap

Complete with Fig. No. 1248 Key and O-Ring.  
Cap Has a Slot Between the Holes.

#### ORDERING INFORMATION

Hose Size Inches	O.D. Flange Inches	Length Neck Inches	Std. Pkg.-1 pc. OEM Pkg.-50 pcs.	Screw Size	Weight Ounces
1½	3½	2½	1269 000 CHR	8	8

Spare Cap with O-Ring, Cat. No. 1269 000 99A.  
Spare Key, Cat. No. 1248 7-8 DP.

Spare O-Rings (2 per bag), Cat. No. 513 008.



Fig. 1269

**NOTE:** These Items Comply with Adopted Standards on "Fittings" A.B.Y.C. Recommended Practices Standards Covering Sewage Holding and/or Treatment Devices for Marine Waste Systems.

## DECK PLATES FOR HOSE FIG. 520



Fig. 520

### Chrome Plated Bronze

Complete with Fig. No. 1248 Key,  
O-Ring and Fig. No. 537 Retaining Cable on Cap.  
Caps Have a Slot Between the Holes.

#### ORDERING INFORMATION

Marked For:	Hose Size Inches	O.D. Flange Inches	Length Neck Inches	Std. Pkg.-1 pc. OEM Pkg.-25 pcs.	Screw Size	Weight Ounces
*Gas	1½	3⅞	3½	520 G00 CHR	8	14
Diesel	1½	3⅞	3½	520 D00 CHR	8	14
Water	1½	3⅞	3½	520 W00 CHR	8	14

Spare Cap with O-Ring and Retaining Cable, Cat. No. 520 000 99A.  
Spare Key, Cat. No. 1248 7-8 DP.

Spare O-Rings (2 per bag), Cat. No. 513 008.

## DECK PLATES FOR HOSE FIG. 521

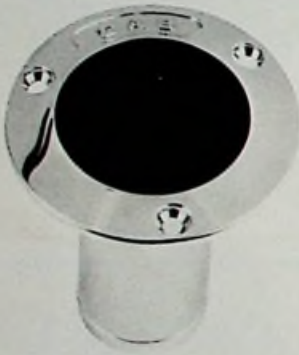

Fig. 521

### Chrome Plated Bronze Black Plastic Cap

Complete with Fig. No. 1248 Key,  
O-Ring and Fig. No. 537 Retaining Cable on Cap.  
Caps Have a Slot Between the Holes.

#### ORDERING INFORMATION

Marked For:	Hose Size Inches	O.D. Flange Inches	Length Neck Inches	Std. Pkg.-1 pc. OEM Pkg.-50 pcs.	Screw Size	Weight Ounces
*Gas	1½	3⅞	3½	521 G00 CHR	8	11
Diesel	1½	3⅞	3½	521 D00 CHR	8	11
Water	1½	3⅞	3½	521 W00 CHR	8	11

Spare Gas Cap with O-Ring and Retaining Cable, Cat. No. 521 G00 99A.  
Spare Diesel Cap with O-Ring and Retaining Cable, Cat. No. 521 D00 99A.  
Spare Water Cap with O-Ring and Retaining Cable, Cat. No. 521 W00 99A.

Spare O-Rings (2 per bag), Cat. No. 513 008.  
Spare Key, Cat. No. 1248 7-8 DP.

## DECK PLATES FOR HOSE FIG. 1270



Fig. 1270

### Chrome Plated Zinc Black Plastic Cap

Complete with Fig. No. 1248 Key,  
O-Ring and Fig. No. 537 Retaining Cable on Cap.  
Caps Have a Slot Between the Holes.

#### ORDERING INFORMATION

Marked For:	Hose Size Inches	O.D. Flange Inches	Length Neck Inches	Std. Pkg.-1 pc. OEM Pkg.-25 pcs.	Screw Size	Weight Ounces
*Gas	1½	3½	2½	1270 G00 CHR	8	8
Diesel	1½	3½	2½	1270 D00 CHR	8	8
Water	1½	3½	2½	1270 W00 CHR	8	8

Spare Gas Cap with O-Ring and Retaining Cable, Cat. No. 1270 G00 99A.  
Spare Diesel Cap with O-Ring and Retaining Cable, Cat. No. 1270 D00 99A.  
Spare Water Cap with O-Ring and Retaining Cable, Cat. No. 1270 W00 99A.

Spare O-Rings (2 per bag), Cat. No. 513 008.  
Spare Key, Cat. No. 1248 7-8 DP.

\*NOTE: These Items Meet the Requirements of U.S.C.G. Safety Standards, January 31, 1977, for Gasoline Fuel Systems, 33CFR183.



## CHROMALEX® FILLS FIGS. 1313, 1329 & 1399

Patent No. 3,828,714

### Chrome Plated Zinc Black Plastic Flange and Cap

Complete with Grounding Screw and Integral Cap Retainer/Gasket.  
Locking Cap Has a Cover for the Key Hole.



Fig. 1313 — Gas  
Fig. 1329 — Water



Fig. 1399



#### ORDERING INFORMATION

Marked For:	For Hose Size Inches	Length Neck Inches	O.D. Overall Inches	ORDERING INFORMATION		Weight Ounces
				Display Pkg.-5 cds. 1 Pc. per card	Std. Pkg.-5 pcs. OEM Pkg.-50 pcs.	
*Gas	1½	1⅞	3⅞	1313 DP CHR	1313 000 CHR	6
Water	1½	1⅞	3⅞	1329 DP BLK	1329 000 BLK	6
*Gas w/Lock	1½	1⅞	3⅞	1399 DP CHR	1399 000 CHR	6

Screw Size #6.

Spare Non-Locking Cap, Cat. No. 126 DP BLK.

Spare Locking Cap, Cat. No. 1324 DP BLK.

## CHROMALEX® GAS FILL FIG. 1413

### Chrome Plated Zinc Black Plastic Cap and Base

Complete with Integral Cap Retainer/Gasket.



Fig. 1413

#### ORDERING INFORMATION

For Hose Inches	Length Neck Inches	Dimensions Overall Inches	ORDERING INFORMATION		Screw Size	Weight Ounces
			Std. Pkg.-1 pc. OEM Pkg.-50 pcs.			
1½	1⅞	3 x 3	*1413 000 CHR		6	7

Spare Cap, Cat. No. 126 DP BLK.

\*NOTE: These Fills Meet the Requirements of U.S.C.G. Safety Standards, January 31, 1977, for Gasoline Fuel Systems, 33CFR183.

## CHROMALEX® CAPS FIGS. 126 & 1324

### Black Plastic Complete with Gasket Fig. 1324 has a Built-in Lock with Cover

Fig. 1324 is Supplied with 2 Keys  
Both Caps Will Fit all PERKO CHROMALEX® Fills

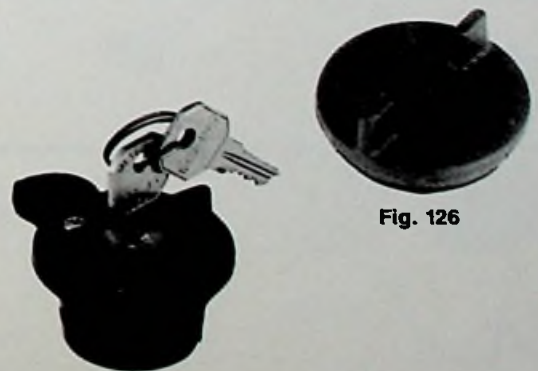

Fig. 126

Fig. 1324

#### ORDERING INFORMATION

	Display Pkg.-5 bags** 1 Pc. per bag	Weight Ounces
Non-Locking	126 DP BLK	½
Locking	1324 DP BLK	3

\*\*All Keyed Alike



## DECK PLATE KEY FIG. 1247



Fig. 1247

**Cast Zinc Chrome Plated**

Compact Size With Hole for Key Chain.  
Will Fit PERKO 1¼" and 1½" Deck Plates  
and Many Other "Slot" Type Opening Deck Plates.

### ORDERING INFORMATION

C. to C. of Lugs	Length Spade Inches	Length Overall Inches	Display Pkg.-10 bags 1 Pc. per bag	Weight Ounces
1½"	1"	1¾"	1247 DP CHR	1



## DECK PLATE KEY FIG. 1248



Fig. 1248

**Plain Zinc**

The Keys For 1" Thru 1½" Deck Plates Have a 1 Inch Spade On Handle That Allows Them to Fit Many Other "Slot" Type Opening Deck Plates.

### ORDERING INFORMATION

For Deck Plate Size Inches	C. to C. Of Lugs Inches	Length Overall Inches	Standard Pkg.-10 pcs.	Display Pkg.-10 bags 1 Pc. per bag	Weight Ounces
1"	5/8"	3 3/8"	1248 006 ZNC	-----	2
1¼ & 1½"	1 1/8"	3 3/8"	-----	1248 7-8 DP	2
2"	1 11/16"	4 3/8"	1248 009 ZNC	-----	2½
2½"	2"	4 3/8"	*1248 010 ZNC	-----	2½

\*Standard Pkg.-1 pc.



## ADJUSTABLE DECK PLATE KEY FIG. 826

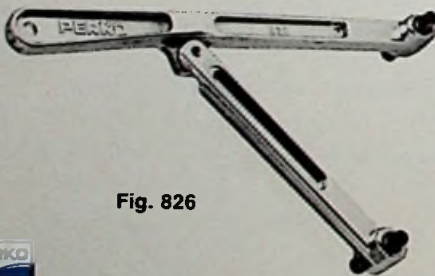

Fig. 826

**Chrome Plated Zinc**

Hardened Steel Pins  
Will Fit Sizes Up To 8 Inch Diameter.

### ORDERING INFORMATION

Length Overall Inches	Display Pkg.-5 cds. 1 Pc. per card	Standard Pkg.-5 pcs.	Weight Ounces
8½"	826 DP CHR	826 000 CHR	9½



## RETAINING CABLE FOR DECK PLATES FIG. 537

**Stainless Steel Cable and Fittings with 1 3/8" Stainless Steel Ring and Self Tapping Screw**



Fig. 537

### ORDERING INFORMATION

Length Cable Inches	Display Pkg.-5 bags 1 Pc. per bag	OEM Pkg.-25 pcs.	Weight Ounces
7"	537 DP	537	½



## REGULAR DECK PLATE FIG. 526

**Cast Bronze  
Plain or Chrome Plated**

Complete with Key

### ORDERING INFORMATION

I.D. Opening Inches	O.D. Overall Inches	Plain Bronze	Chrome Plated Bronze	Screw Size	Weight Pounds
		Standard Pkg.-1 pc.	Standard Pkg.-1 pc.		
3	5 $\frac{5}{8}$	526 003 PLB	526 003 CHR	10	2
4	7 $\frac{1}{16}$	526 004 PLB	526 004 CHR	10	3 $\frac{3}{8}$
5	8 $\frac{3}{8}$	526 005 PLB	526 005 CHR	10	4 $\frac{3}{4}$
6	9 $\frac{3}{8}$	526 006 PLB	526 006 CHR	$\frac{1}{4}$	7 $\frac{1}{2}$
8	10 $\frac{1}{4}$	526 008 PLB	-----	$\frac{1}{4}$	8 $\frac{3}{4}$

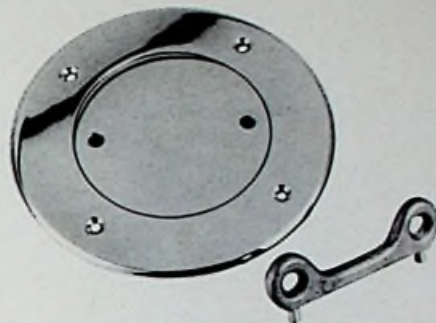

Fig. 526

### SPARE PARTS ORDERING INFORMATION

I.D. Opening Inches	Plain Bronze Cap	Chrome Plated Bronze Cap	Spare Key Only
3	526 P03 99A	526 C03 99A	539 003 ZNC
4	526 P04 99A	526 C04 99A	539 004 PLB
5	526 P05 99A	526 C05 99A	539 005 PLB
6	526 P06 99A	526 C06 99A	539 006 PLB
8	526 P08 99A	-----	539 008 PLB

## WATER INLET FITTING FIG. 499

**Chrome Plated Bronze**

Standard Female Swivel Hose Connector.  
Complete With Black Plastic Watertight Plug and Stainless Steel Bead Chain.

For Obtaining Water Under Pressure At Dockside.

### ORDERING INFORMATION

Pipe Size Inches	O.D. Flange Inches	Display Pkg.-5 cds. 1 Pc. per card	Std. Pkg.-5 pcs. OEM Pkg.-25 pcs.	Screw Size	Weight Ounces
$\frac{1}{2}$	2 $\frac{3}{4}$	499 DP CHR	499 000 CHR	8	8

Spare Plug with Chain, Cat. No. 499 DP 99A.



Fig. 499



## WATER OUTLET FITTING FIG. 504

**Chrome Plated Bronze**

Standard Male Hose Connector.  
Complete with a Watertight Black Plastic Cap and Stainless Steel Bead Chain.  
For Use with On-board Washdown Systems.

### ORDERING INFORMATION

Pipe Size Inches	O.D. Flange Inches	Display Pkg.-5 cds. 1 Pc. per card	Std. Pkg.-5 pcs. OEM Pkg.-10 pcs.	Screw Size	Weight Ounces
$\frac{1}{2}$	2 $\frac{3}{4}$	504 DP CHR	504 000 CHR	8	8

Spare Cap with Chain, Cat. No. 504 DP 99A.

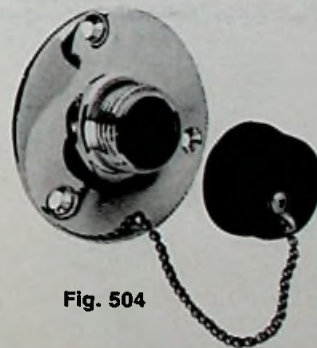

Fig. 504



## THRU-HULL SCUPPERS FIGS. 323 & 356

### Molded White Plastic Soft Black Flapper Valve

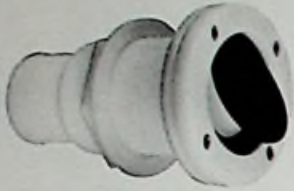

Fig. 323

Fig. 323 Complete With Nut And Mounting Hardware.  
For Mounting Through The Transom.

Fig. 356 Without Nut And Mounting Hardware.  
For Mounting On Outboard Wells, etc.

#### ORDERING INFORMATION

Hose Size Inches	Maximum Hull Thickness Inches	O.D. Flange Inches	Std. Pkg.-5 pcs. OEM Pkg.-50 pcs.	Weight Ounces
1½	2⅞	2⅞	323	5
1½	2⅞	2⅞	356	5



Fig. 365

## SCUPPER VALVE ASSEMBLY FIG. 365

### Molded White Plastic Soft Black Flapper Valve

Without Thru-Hull and Mounting Hardware.  
For Surface Mount Applications.

#### ORDERING INFORMATION

O.D. Flange Inches	Display Pkg.-5 bags 1 Pc. per bag	Std. Pkg.-5 pcs. OEM Pkg.-50 pcs.	Weight Ounces
2⅞	365 DP	365	1



Fig. 285

## COCKPIT SCUPPER FIG. 285

### Molded White Plastic Flush Mount

For Use When Discharge is Above the Waterline.  
Insert Prevents Passage of Large Objects  
Without Restricting Water Flow.

#### ORDERING INFORMATION

Hose Size Inches	Maximum Hull Thickness Inches	O.D. Flange Inches	I.D. Inches	Std. Pkg.-5 pcs. OEM Pkg.-50 pcs.	Weight Ounces
1½	1¾	2¾	1½	285	5

## COCKPIT SCUPPER FIG. 142

**Cast Bronze**  
**Plain or Chrome Plated**

**Rubber Check Ball**

Complete With Key.  
For Use When Discharge Is Below The Waterline.  
Angle Of Outlet Is 45 Degrees.

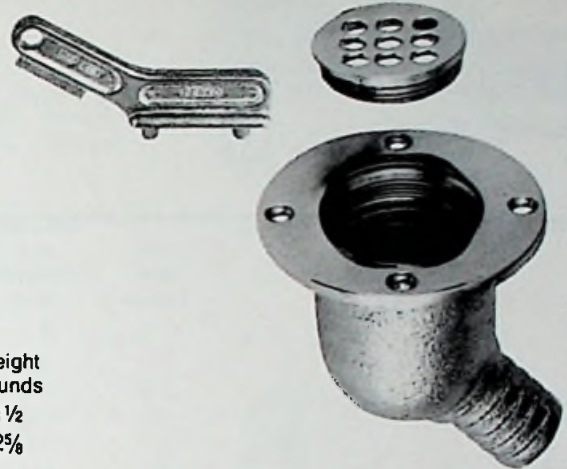

Fig. 142

### ORDERING INFORMATION

Hose Size Inches	O.D. Grate Inches	O.D. Flange Inches	Plain Bronze Std. Pkg.-1 pc.	Chrome Plated Bronze Std. Pkg.-1 pc.	Weight Pounds
1	1 <sup>3</sup> / <sub>16</sub>	3 <sup>1</sup> / <sub>4</sub>	142 001 PLB	142 001 CHR	1 <sup>1</sup> / <sub>2</sub>
1 <sup>1</sup> / <sub>2</sub>	2 <sup>1</sup> / <sub>4</sub>	3 <sup>3</sup> / <sub>4</sub>	142 002 PLB	*142 002 CHR	2 <sup>5</sup> / <sub>8</sub>

\*O.E.M. Pkg.-10 pcs.  
Screw Size #8.

### SPARE PARTS ORDERING INFORMATION

Hose Size Inches	Plain Bronze Grate	Chrome Plated Bronze Grate	Check Ball Only	Spare Key Only
1	142 P01 99A	142 C01 99A	142 001 99B	1248 7-8 DP
1 <sup>1</sup> / <sub>2</sub>	142 P02 99A	142 C02 99A	142 002 99B	1248 7-8 DP

## THRU-HULL CONNECTION FIG. 322

**Cast Bronze**

Flange is Machined to Fit Hull and Grooved to Retain Bedding Compound.  
Neck is Threaded to Approximately <sup>3</sup>/<sub>8</sub> Inch from Flange.

### ORDERING INFORMATION

Pipe Size Inches	Maximum Hull Thickness Inches	O.D. Flange Inches	Standard Package-1 pc.	OEM Pkg.	Spare Flanged Nut Only	Weight Pounds
<sup>3</sup> / <sub>8</sub>	1 <sup>3</sup> / <sub>4</sub>	1 <sup>1</sup> / <sub>2</sub>	322 003 PLB	25	75 003 PLB	<sup>3</sup> / <sub>8</sub>
<sup>1</sup> / <sub>2</sub>	1 <sup>3</sup> / <sub>8</sub>	1 <sup>3</sup> / <sub>8</sub>	322 004 PLB	25	75 004 PLB	<sup>3</sup> / <sub>8</sub>
<sup>3</sup> / <sub>4</sub>	1 <sup>1</sup> / <sub>2</sub>	1 <sup>7</sup> / <sub>8</sub>	322 005 PLB	25	75 005 PLB	<sup>1</sup> / <sub>2</sub>
1	1 <sup>7</sup> / <sub>8</sub>	2 <sup>1</sup> / <sub>4</sub>	322 006 PLB	25	75 006 PLB	<sup>7</sup> / <sub>8</sub>
1 <sup>1</sup> / <sub>4</sub>	2	2 <sup>7</sup> / <sub>8</sub>	322 007 PLB	25	75 007 PLB	1 <sup>1</sup> / <sub>4</sub>
1 <sup>1</sup> / <sub>2</sub>	2 <sup>1</sup> / <sub>4</sub>	3	322 008 PLB	10	75 008 PLB	1 <sup>3</sup> / <sub>4</sub>
2	2 <sup>3</sup> / <sub>8</sub>	3 <sup>5</sup> / <sub>8</sub>	322 009 PLB	—	75 009 PLB	2
2 <sup>1</sup> / <sub>2</sub>	2 <sup>5</sup> / <sub>8</sub>	4 <sup>7</sup> / <sub>16</sub>	322 010 PLB	—	75 010 PLB	3 <sup>1</sup> / <sub>2</sub>
3	2 <sup>3</sup> / <sub>4</sub>	5	322 011 PLB	—	75 011 PLB	5



Fig. 322



## EXTRA LONG THRU-HULL CONNECTION FIG. 348

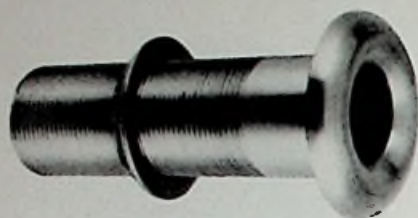

Fig. 348



**Cast Bronze**

Similar to Fig. 322 Except Extended Neck is Threaded to Between 1 and 1½ Inches from Flange.

### ORDERING INFORMATION

Pipe Size Inches	Maximum Hull Thickness Inches	O.D. Flange Inches	Standard Pkg.-1 pc.	OEM Pkg.	Spare Flanged Nut Only	Weight Pounds
¾	5	1⅞	348 005 PLB	25	75 005 PLB	⅞
1	4⅞	2¼	348 006 PLB	10	75 006 PLB	1¼
1¼	4⅝	2¾	348 007 PLB	10	75 007 PLB	2⅞
1½	4⅝	3	348 008 PLB	10	75 008 PLB	2¼
2	4½	3⅝	348 009 PLB	---	75 009 PLB	3
2½	4¼	4⅝	348 010 PLB	---	75 010 PLB	4

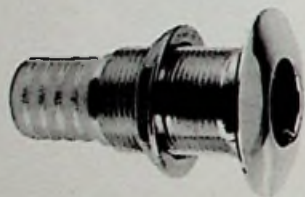

Fig. 350



## THRU-HULL CONNECTION FIG. 350

**Cast Bronze**  
**Plain or Chrome Plated**  
**For Use With Hose\*\***

Flange is Machined to Fit Hull and Grooved to Retain Bedding Compound. Neck is Threaded to Approximately ¾ Inch From Flange.

### ORDERING INFORMATION

Hose Size Inches	Maximum Hull Thickness Inches	O.D. Flange Inches	Plain Bronze Standard Pkg.-1 pc.	Chrome Plated Bronze Standard Pkg.-1 pc.	OEM Pkg.	Spare Flanged Nut Only	Weight Pounds
⅝	1⅞	1½	*350 004 PLB	350 004 CHR	25	75 004 PLB	⅞
¾	1⅝	1⅞	350 005 PLB	350 005 CHR	10	75 005 PLB	½
1	1¾	2¼	350 006 PLB	350 006 CHR	10	75 006 PLB	⅞
1⅞	1¾	2¼	350 06A PLB	350 06A CHR	10	75 006 PLB	⅞
1¼	1⅞	2¾	350 007 PLB	*350 007 CHR	10	75 007 PLB	1⅞
1½	1⅞	3⅞	350 008 PLB	350 008 CHR	10	75 008 PLB	1½

\*No O.E.M. Package Available.



\*\*NOTE: Thru-Hull Connections For Use With Hose Are Not Recommended For Use Below The Waterline Per A.B.Y.C. "Safety Standards For Small Craft" Section H-27.

## THRU-HULL CONNECTION FIG. 311

Chrome Plated Bronze

For Use With Hose\*\*

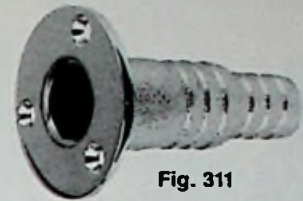

Fig. 311

### ORDERING INFORMATION

Hose Size Inches	Length Overall Inches	I.D. Inches	O.D. Flange Inches	Standard Pkg.-1 pc.	Screw Size	Weight Ounces
3/4 & 1	3 1/8	9/16	2	311 000 CHR	8	8



## THRU-HULL CONNECTION FIG. 301

Molded White Plastic

Narrow Flange

For Use With Hose\*\*

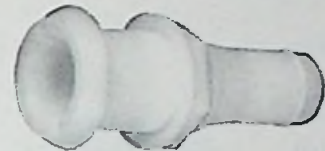

Fig. 301

### ORDERING INFORMATION

Hose Size Inches	Maximum Hull Thickness Inches	O.D. Flange Inches	Standard Pkg.-10 pcs.	OEM Pkg.	Weight Ounces
1/2	1 1/4	1 1/4	301 004	100	1
5/8	1 1/4	1 1/4	301 04A	100	1
3/4	1 7/16	1 1/2	301 005	100	1 1/2
1	1 1/2	1 7/8	*301 006	50	2
1 1/8	1 1/2	1 7/8	*301 06A	50	2
1 1/2	1 7/8	2 1/2	*301 008	50	4



\*Std. Pkg.-5 pieces.

## THRU-HULL CONNECTION FIG. 328

Molded White Plastic

Broad Flange

For Use With Hose\*\*



Fig. 328

### ORDERING INFORMATION

Hose Size Inches	Maximum Hull Thickness Inches	O.D. Flange Inches	Display Pkg.-10 bags 1 Pc. per bag	Standard Pkg.-10 pcs.	OEM Pkg.	Weight Ounces
1/2	1 1/4	1 1/2	328 DP4	328 004	100	1
5/8	1 1/4	1 1/2	328 DP4A	328 04A	100	1
3/4	1 7/16	2 1/16	328 DP5	328 005	100	1 1/2
1	1 1/2	2 1/4	*328 DP6	**328 006	50	2
1 1/8	1 1/2	2 1/4	*328 DP6A	**328 06A	50	2
1 1/2	1 7/8	3	*328 DP8	**328 008	50	4

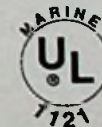

\*Display Pkg.-5 bags

\*\*Std. Pkg.-5 pieces



\*\*NOTE: Thru-Hull Connections For Use With Hose Are Not Recommended For Use Below The Waterline Per A.B.Y.C. "Safety Standards For Small Craft" Section H-27.

## SEACOCKS FIGS. 834 & 835

Ball Valve Design

Cast Bronze

Complete With Thru-Hull, Hose Adapter, Drain Plug, Four Pre-Drilled Mounting Holes and Bonding Screw.

Fig. 834 — With 90° Curved Hose Adapter.  
Fig. 835 — With Straight Hose Adapter.

PERKO Seacocks Incorporate a Plastic Ball and Seat Assuring a Tight Seal and Ease of Operation. Drain Plugs for Winterizing. Handles Easily Removed.



Fig. 834



Fig. 835

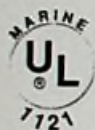

### ORDERING INFORMATION

Hose Size Inches	Pipe Size Inches	Fig. 834 Standard Pkg.-1 pc.	Fig. 835 Standard Pkg.-1 pc.	OEM Pkg.	Bolt Size	Weight Pounds
3/4	3/4	834 005 PLB	835 005 PLB	5	5/16	3 1/8
1	1	834 006 PLB	835 006 PLB	--	3/8	5 1/8
1 1/4	1 1/4	834 007 PLB	835 007 PLB	5	3/8	6 3/4
1 1/2	1 1/2	834 008 PLB	*835 008 PLB	5	3/8	10
2	2	834 009 PLB	835 009 PLB	--	3/8	22
2 1/2	2 1/2	834 010 PLB	835 010 PLB	--	1/2	25
3	3	834 011 PLB	835 011 PLB	--	1/2	32

\*No O.E.M. Package Available.

## SEACOCK BODY FIG. 805

Ball Valve Design

Cast Bronze

These Valve Bodies are Offered to Meet the Needs of Applications that Require Extra Long, Scoop or Flush Type Thru-Hulls.



Fig. 805

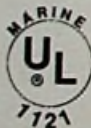

### ORDERING INFORMATION

Pipe Size Inches	Standard Pkg.-1 pc.	OEM Pkg.	Weight Pounds
3/4	805 005 PLB	5	2 1/2
1	805 006 PLB	5	4
1 1/4	805 007 PLB	5	5 1/8
1 1/2	805 008 PLB	5	6 3/8
2	805 009 PLB	--	11 3/8
2 1/2	805 010 PLB	--	19
3	805 011 PLB	--	24

### SPARE PARTS ORDERING INFORMATION

The Repair Kits Listed Below Consists of: 1 Ball, 2 Ball Seats and 2 O-Rings for the Valve Stem.

Pipe Size Inches	Repair Kit	Pipe Size Inches	Repair Kit	Pipe Size Inches	Repair Kit
3/4	805 005 99B	1 1/2	805 008 99B	3	805 011 99B
1	805 006 99B	2	805 009 99B		
1 1/4	805 007 99B	2 1/2	805 010 99B		



## INLINE VALVE FIG. 825

**Cast Bronze**

Complete with Drain Plug and Bonding Screw.  
Ball Valve for Smooth Operation.

### ORDERING INFORMATION

Pipe Size Inches	Standard Pkg.-1 pc.	OEM Pkg.	Weight Pounds
1/2	825 004 PLB	10	1
3/4	825 005 PLB	10	1 1/4
1	825 006 PLB	10	1 3/4
1 1/4	825 007 PLB	10	2 3/4
1 1/2	825 008 PLB	5	4 1/4



Fig. 825

## PIPE TO HOSE ADAPTER FIG. 63

**Cast Bronze**  
**Curved 90 Degrees**

### ORDERING INFORMATION

Pipe Size Inches	Hose Size Inches	Length Overall Inches	Standard Pkg.-1 pc.	OEM Pkg.	Weight Pounds
3/4	3/4	4 1/4	63 005 PLB	25	1/2
1	1	4 3/4	63 006 PLB	25	3/4
1 1/4	1 1/4	5 1/2	63 007 PLB	25	1
1 1/2	1 1/2	6	63 008 PLB	10	1 1/4
2	2	7	63 009 PLB	—	2 1/2
2 1/2	2 1/2	8 1/2	63 010 PLB	—	3 7/8
3	3	10	63 011 PLB	—	6 3/8



Fig. 63



NOTE: The Above Item Meets the Requirements of U.S.C.G. Safety Standards, January 31, 1977 for Gasoline Fuel Systems, 33CFR183.

## PIPE TO HOSE ADAPTER FIG. 76

**Cast Bronze**

### ORDERING INFORMATION

Pipe Size Inches	Hose Size Inches	Length Overall Inches	Standard Pkg.-1 pc.	OEM Pkg.	Weight Pounds
1/2	5/8	1 5/8	76 004 PLB	25	1/8
3/4	3/4	1 3/4	76 005 PLB	25	1/4
1	1	1 3/4	76 006 PLB	25	3/8
1 1/4	1 1/4	2	76 007 PLB	25	1/2
1 1/2	1 1/2	2 1/4	76 008 PLB	25	3/4
2	2	2 5/8	76 009 PLB	25	1
2 1/2	2 1/2	4	76 010 PLB	—	2 1/8
3	3	5 1/8	76 011 PLB	—	3



Fig. 76



NOTE: The Above Item Meets the Requirements of U.S.C.G. Safety Standards, January 31, 1977 for Gasoline Fuel Systems, 33CFR183.

## INTAKE STRAINER FIG. 65



Fig. 65



**Cast Bronze**

### ORDERING INFORMATION

Pipe Size Inches	Maximum Hull Thickness Inches	Dimensions Strainer Inches	Std. Pkg.-1 pc. OEM Pkg.-10 pcs.	Spare Flanged Nut Only	Weight Pounds
1/2	2 1/4	3 x 4	65 004 PLB	75 004 PLB	3/4
3/4	2 3/16	3 x 4	65 005 PLB	75 005 PLB	1
1	2 1/2	3 x 4	65 006 PLB	75 006 PLB	1 1/4
1 1/4	3	3 1/4 x 4 1/4	65 007 PLB	75 007 PLB	2

Screw Size #8.

## SCOOP STRAINER FIG. 66



Fig. 66



**Cast Bronze**

### ORDERING INFORMATION

For Thru-Hull Size Inches	Dimensions Overall Inches	Standard Pkg.-5 pcs.	Weight Pounds
1/2	3 1/2 x 2 1/2	66 001 PLB	1 3/4
1	5 x 3 1/4	66 002 PLB	4 1/2
1 1/4	6 1/4 x 4 1/4	66 003 PLB	6 3/8
2	8 x 5 1/8	66 004 PLB	10

Screw Size #8.

## ROUND STRAINER FIG. 86



Fig. 86



**Cast Bronze**

### ORDERING INFORMATION

For Thru-Hull Size Inches	O.D. Inches	I.D. Inches	Standard Pkg.-5 pcs.	OEM Pkg.	Screw Size	Weight Pounds
1/2	2 1/2	1 5/8	86 001 PLB	—	8	3/16
3/4	3	2	86 002 PLB	25	8	1/4
1	3 1/2	2 3/8	86 003 PLB	25	8	3/8
1 1/4	4	3	86 004 PLB	—	8	1/2
2	5	3 3/4	86 005 PLB	25	8	3/4
2 1/2	6	4 1/2	*86 006 PLB	10	10	1 1/4
3	8	6 1/4	*86 007 PLB	—	10	2 1/2

\*Standard Pkg.-1 pc.

## PUMP STRAINER FIG. 709

Cast Bronze



Fig. 709



### ORDERING INFORMATION

Hose Size Inches	Length Overall Inches	Width Overall Inches	Display Pkg.-5 bags 1 Pc. per bag	Std. Pkg.-5 pcs. OEM Pkg.-25 pcs.	Weight Ounces
5/8	3 5/8	1 3/4	709 DP PLB	709 000 PLB	6

## PUMP STRAINERS FIGS. 704 & 705

Cast Bronze



Fig. 704

### ORDERING INFORMATION

Hose Size Inches	Length Overall Inches	Width Overall Inches	Standard Pkg.-1 pc.	OEM Pkg.	Weight Pounds
1 1/4	6 3/8	2 3/4	704 000 PLB	10	2
1 1/4	4 1/2	2 3/4	705 000 PLB	---	1 1/2



Fig. 705

## PUMP STRAINERS FIGS. 721 & 722

Cast Bronze

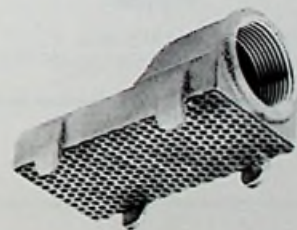

Fig. 721

### ORDERING INFORMATION

Pipe Size Inches	Length Overall Inches	Width Overall Inches	Standard Pkg.-1 pc.	OEM Pkg.	Weight Pounds
1 1/4	4 3/4	2 3/4	721 000 PLB	---	1 3/4
1 1/4	4 1/2	2 3/4	722 000 PLB	10	1 3/8

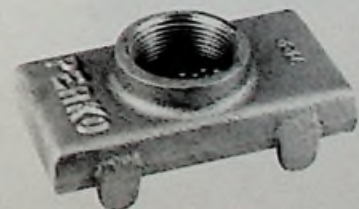

Fig. 722

## FUEL FILTER AND SEPARATOR FIG. 299

Cast Bronze

Microporous Filter Element

Complete with Adjustable Mounting Bracket, Drain Plug and O-Ring.  
These Units Separate Water from Gasoline or Diesel Fuel and  
Filter Out Particles of 40 Microns or Larger in Size.

### ORDERING INFORMATION

Pipe Size Inches	Height Overall Inches	O.D. Overall Inches	Standard Pkg.-1 pc.	Dimensions Element Inches	Screw Size	Weight Pounds
3/8	5 1/2	2 3/8	299 001 PLB	1 3/4 x 1 3/4	8	3 3/4
1/2	6 1/4	3 1/8	299 002 PLB	2 1/4 x 2	10	5 1/2

Spare Element and O-Ring for 3/8", Cat. No. 324 001 ELM.  
Spare Element and O-Ring for 1/2", Cat. No. 324 002 ELM.



Fig. 299



NOTE: This Item Meets the Requirements of U.S.C.G. Safety Standards, January 31, 1977, for Gasoline Fuel Systems, 33CFR183.

## TRANSOM DRAIN PLUG FIG. 414

Brass  
Black Plastic Handle  
Expandable Plug



Fig. 414

I.D. Tube Inches	Length Tube Inches	Length Overall Inches	Display Pkg.-10 bags 1 Pc. per bag	Standard Pkg.-10 pcs.	Weight Ounces
1	2	2 1/2	414 DP1 PLB	414 001 PLB	3 1/2

Spare Plug, Cat. No. 414 DP 99A.  
Spare Tube, Cat. No. 414 001 99B.

## GARBOARD DRAIN PLUGS FIGS. 263, 266 & 363

### Cast Bronze

#### ORDERING INFORMATION

Pipe Size Inches	Length Threaded Neck Inches	O.D. Flange Inches	Standard Pkg.-5 pcs.	OEM Pkg.	Screw Size	Weight Ounces
3/4	5/8	2 3/8	263 000 PLB	---	8	12
3/4	5/8	2 3/8	266 000 PLB	---	8	12
3/4	1 1/4	2 3/8	*363 000 PLB	25	-	15

\*Maximum Hull Thickness 3/4 inch.

Spare Plug, Cat. No. 370 000 PLB.



Fig. 263

Fig. 266

Fig. 363



## GARBOARD DRAIN PLUGS FIGS. 714 & 737

### Cast Bronze Flange Brass Plug

Fig. 737 Complete With Brass Backing Plate and Fasteners.  
No. 2 Style has Stainless Steel Pins.

#### ORDERING INFORMATION

Pipe Size Inches	Maximum Hull Thickness Inches	O.D. Flange Inches	Display Pkg.-5 bags 1 Pc. per bag	Standard Pkg.-5 pcs.	Screw Size	Weight Ounces
1/2	---	2	714 DP1 PLB	*714 001 PLB	8	4
1/2	---	2	-----	*714 002 PLB	8	4
1/2	7/16	2	-----	*737 001 PLB	8-32	5
1/2	7/16	2	-----	737 002 PLB	8-32	5

\*O.E.M. Pkg.-50 pcs.

Spare No. 1 Plug, Cat. No. 742 001

Spare No. 2 Plug, Cat. No. 742 002



Fig. 714 No. 1

Fig. 714 No. 2



Fig. 737 No. 1

Fig. 737 No. 2

## GARBOARD DRAIN PLUG FIG. 124

### Cast Bronze Flange Brass Plug

Complete with Zinc Plated Steel Wrench.

#### ORDERING INFORMATION

Pipe Size Inches	Length Threaded Neck Inches	O.D. Flange Inches	Standard Pkg.-5 pcs.	Screw Size	Weight Pounds
1	1	3 1/2	124 000 PLB	10	1 1/4

Spare Wrench, Cat. No. 124 000 99A.

Spare Plug, Cat. No. 124 000 99B.



Fig. 124



## STUFFING BOX FIG. 320

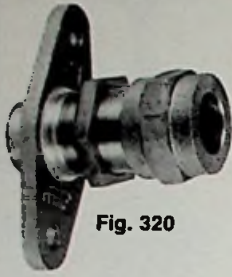

Fig. 320

Cast Bronze

### ORDERING INFORMATION

For Shaft O.D. Inches	Dimensions Flange Inches	Length Bearing Inches	Standard Pkg.-1 pc.	Bolt Size Inches	Weight Pounds
3/4	4 x 1 3/4	2 1/8	320 003 PLB	3/8	1 1/8
1	4 1/4 x 2 1/8	2 5/8	320 005 PLB	7/16	1 3/4
1 1/8	4 7/8 x 2 1/8	2 7/8	320 006 PLB	1/2	2 1/4
1 1/4	5 3/4 x 2 3/8	2 7/8	320 007 PLB	1/2	3
1 1/2	6 1/2 x 3	3	320 009 PLB	1/2	3 1/2

## STUFFING BOX FIG. 672

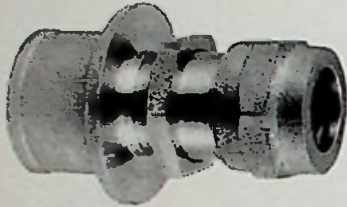

Fig. 672

Cast Bronze

### ORDERING INFORMATION

For Shaft Log Cat. No.	For Shaft O.D. Inches	Length Neck Inches	Length Bearing Inches	Standard Pkg.-1 pc.	Weight Pounds
-----	7/8	1 3/16	1 5/8	672 004 PLB	1 1/2
671 005 PLB	1	1 3/16	1 5/8	672 005 PLB	1 1/2
671 007 PLB	1 1/4	1 11/16	2	672 007 PLB	2 1/2
671 009 PLB	1 1/2	2	2 1/4	672 009 PLB	3 3/8

## HEAVY DUTY STUFFING BOX FIG. 819

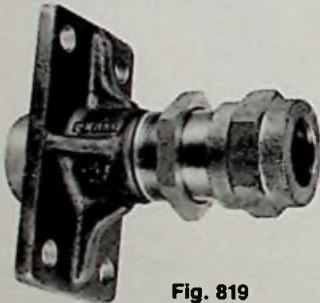

Fig. 819

Cast Bronze

### ORDERING INFORMATION

For Shaft O.D. Inches	Dimensions Flange Inches	Length Bearing Inches	Standard Pkg.-1 pc.	Bolt Size	Weight Pounds
1 1/4	5 5/8 x 3 5/8	4 1/4	819 007 PLB	1/2	6 1/2
1 1/2	6 x 4 3/8	5 1/2	819 009 PLB	1/2	10

## SELF-ALIGNING STUFFING BOX FIG. 734

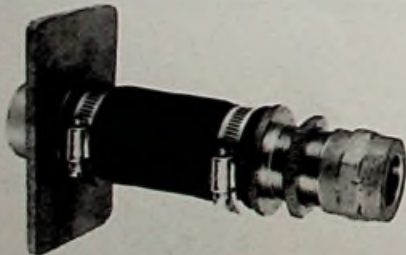

Fig. 734

Cast Bronze  
Flange Not Drilled

### ORDERING INFORMATION

For Shaft O.D. Inches	Dimensions Flange Inches	Length from Flange to End of Box* Inches	Standard Pkg.-1 pc.	Weight Pounds
1	5 x 3 1/4	6 3/4	734 005 PLB	5
1 1/4	6 x 4 1/4	7 3/4	734 007 PLB	9 1/2
1 1/2	7 x 4 1/2	8 1/4	734 009 PLB	13

\*NOTE: Length Does Not Include Packing Nut or Space For Packing.

NOTE: 3/16" Flax Packing Fits All Sizes of the Above Stuffing Boxes.

## SELF-ALIGNING SHAFT LOG FIG. 671

Cast Bronze

### ORDERING INFORMATION

For Shaft O.D. Inches	Dimensions Base Inches	Length Overall Inches	Degrees Of Angle	Standard Pkg.-1 pc.	Weight Pounds
1	11 $\frac{3}{8}$ x 3 $\frac{1}{2}$	18	12	671 005 PLB	5 $\frac{1}{4}$
1 $\frac{1}{4}$	16 $\frac{1}{2}$ x 4 $\frac{1}{4}$	23 $\frac{1}{2}$	10	671 007 PLB	10 $\frac{1}{4}$
1 $\frac{1}{2}$	19 x 5	28	10	671 009 PLB	17 $\frac{3}{4}$



Fig. 671

NOTE:  $\frac{3}{16}$ " Flax Packing Fits All Sizes of the Above Shaft Log.  
All Bases Are Spotted For Bolt Holes, But Not Drilled.

## RUDDER STUFFING BOX FIG. 1088

Cast Bronze

### ORDERING INFORMATION

For Shaft O.D. Inches	Dimensions Flange Inches	Length Bearing Inches	Standard Pkg.-1 pc.	Bolt Size	Weight Pounds
1	3 $\frac{3}{4}$ x 3 $\frac{3}{4}$	5 $\frac{1}{4}$	1088 005 PLB	$\frac{3}{8}$	3
1 $\frac{1}{4}$	3 $\frac{3}{4}$ x 3 $\frac{3}{4}$	6 $\frac{1}{4}$	1088 007 PLB	$\frac{3}{8}$	4



Fig. 1088

NOTE:  $\frac{3}{16}$ " Flax Packing Fits All Sizes of Above Stuffing Box.

## STUFFING BOX HOSE FIG. 673

### ORDERING INFORMATION

For Shaft Log Cat. No.	Standard Pkg.-1 pc.	I.D. Inches	Length Overall Inches	Weight Ounces
	673 004	1 $\frac{1}{4}$	4	3
671 005 PLB	673 005	1 $\frac{3}{4}$	4	3
671 007 PLB	673 007	2 $\frac{1}{8}$	5	10
671 009 PLB	673 009	2 $\frac{5}{8}$	5	10

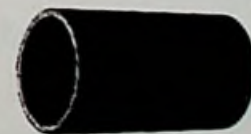

Fig. 673

## UNIVERSAL STRUT FIG. 1055

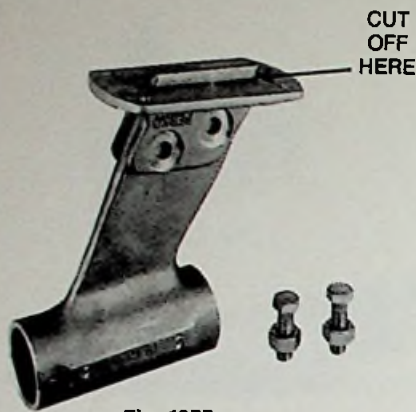

Fig. 1055

### Manganese Bronze For Rubber Bearings (Not Included)

These Struts Can Be Made Any Length Shorter Than Standard By Sliding the Shank Up Through the Base to the Required Length. The Necessary Angle for the Shaft is Also Obtained in the Same Way. Extreme Drop to Center of Shaft is 7 Inches.

#### ORDERING INFORMATION

For Shaft O.D. Inches	For Bearing O.D. Inches	Dimensions Base Inches	Length Bearing Inches	Standard Pkg.-1 pc.	Bolt Size	Weight Pounds
1	1½	5⅜ × 3⅜	4	1055 005 PLB	⅝	7½
1¼	1¾	5⅝ × 3⅝	5	1055 007 PLB	⅝	7½



Fig. 815

## BRONZE COLLAR FIG. 815

#### ORDERING INFORMATION

For Shaft O.D. Inches	O.D. Inches	Length Inches	Standard Pkg.-1 pc.	Weight Ounces
1	1¾	1⅝	815 005 PLB	7
1¼	2⅞	1⅝	815 007 PLB	11
1½	2½	1⅞	815 009 PLB	19



Fig. 307

## CAULKING IRON FIG. 307

### Malleable Iron

#### ORDERING INFORMATION

Thickness Blade Inches	Width Blade Inches	Length Overall Inches	Standard Pkg.-10 pcs.	Weight Ounces
⅓₂	2	5	307 000	5
⅙₁₆	2½	5⅝	307 00A	6½
⅙₈	2¼	5⅞	307 001	7

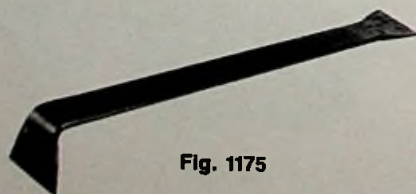

Fig. 1175

## DOUBLE END SCRAPER FIG. 1175

### Heat Treated Steel

#### ORDERING INFORMATION

Length Overall Inches	Width Blade Inches	Width Shank Inches	Thickness Shank Inches	Standard Pkg.-5 pcs.	Weight Pounds
15	1¾	1	¼	1175	1



## CLOSED BASE CLEAT FIG. 566

Chrome Plated Zinc



Fig. 566

### ORDERING INFORMATION

Length Overall Inches	Dimensions Base Inches	Max. Rope Size Inches	Display Pkg.	Standard Pkg.	Display Pkg.-5 cds. Pcs. per card	Std. Pkg.	Screw Size	Weight Ounces
2	2 <sup>3</sup> / <sub>16</sub> x 1 <sup>1</sup> / <sub>8</sub>	5 <sup>1</sup> / <sub>16</sub>	566 DP2 CHR	566 002 CHR	2	10	6	1 <sup>1</sup> / <sub>2</sub>
3	3 <sup>1</sup> / <sub>8</sub> x 1 <sup>1</sup> / <sub>2</sub>	3 <sup>3</sup> / <sub>8</sub>	566 DP3 CHR	566 003 CHR	2	10	8	4 <sup>1</sup> / <sub>2</sub>
4 <sup>1</sup> / <sub>2</sub>	4 <sup>7</sup> / <sub>16</sub> x 1 <sup>7</sup> / <sub>8</sub>	1/2	566 DP4 CHR	566 004 CHR	2	10	10	8 <sup>1</sup> / <sub>2</sub>
6	5 <sup>1</sup> / <sub>2</sub> x 2	3/4	566 DP6 CHR	566 006 CHR	1	5	12	13 <sup>1</sup> / <sub>2</sub>



## CLOSED BASE CLEAT FIG. 1251

Chrome Plated Zinc



Fig. 1251

### ORDERING INFORMATION

Length Overall Inches	Dimensions Base Inches	Max. Rope Size Inches	Display Pkg.-10 bags 1 Pc. per bag	Standard Pkg.-10 pcs.	OEM Pkg.	Screw Size	Weight Ounces
3	1 <sup>3</sup> / <sub>8</sub> x 1 <sup>3</sup> / <sub>16</sub>	3/8	1251 DP3 CHR	1251 003 CHR	—	8	2 <sup>1</sup> / <sub>3</sub>
4 <sup>1</sup> / <sub>2</sub>	1 <sup>1</sup> / <sub>2</sub> x 1 <sup>1</sup> / <sub>4</sub>	1/2	1251 DP4 CHR	1251 004 CHR	50	8	6



## OPEN BASE CLEAT FIG. 1252

Chrome Plated Zinc



Fig. 1252

### ORDERING INFORMATION

Length Overall Inches	Dimensions Base Inches	Max. Rope Size Inches	Display Pkg.-5 cds. 2 Pcs. per card	Std. Pkg.-10 pcs. OEM Pkg.-50 pcs.	Screw Size	Weight Ounces
6 <sup>1</sup> / <sub>2</sub>	3 x 1 <sup>1</sup> / <sub>8</sub>	3/4	1252 DP CHR	1252 000 CHR	1/4	7





Fig. 572

## OPEN BASE CLEAT FIG. 572

Chrome Plated Bronze

### ORDERING INFORMATION

Length Overall Inches	Dimensions Base Inches	Display Pkg. -5 cds. 1 Pc. per card	Standard Pkg.	Std. Pkg.	OEM Pkg.	Screw Size	Weight Pounds
*4½	2 <sup>5</sup> / <sub>16</sub> × 1 <sup>11</sup> / <sub>16</sub>	-----	572 04A CHR	10	---	10	½
*5½	2 <sup>13</sup> / <sub>16</sub> × 1¾	-----	572 05A CHR	10	---	10	5/8
*6½	3 <sup>5</sup> / <sub>16</sub> × 1 <sup>7</sup> / <sub>8</sub>	572 DP6 CHR	572 06A CHR	5	10	12	¾
8	4 × 2¼	572 DP8 CHR	572 008 CHR	5	10	¼	1¼
10	5 <sup>1</sup> / <sub>16</sub> × 2 <sup>13</sup> / <sub>16</sub>	-----	572 010 CHR	1	---	5/16	1¾
12	6 <sup>1</sup> / <sub>16</sub> × 2 <sup>7</sup> / <sub>8</sub>	-----	572 012 CHR	1	---	5/16	2½

\*These Sizes Are Solid, Balance of Sizes Are Hollow.

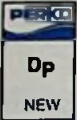

Fig. 1188

## OPEN BASE CLEAT FIG. 1188

Chrome Plated Zinc

### ORDERING INFORMATION

Length Overall Inches	Dimensions Base Inches	Display Pkg.	Standard Pkg.	Display Pkg. -5 cds. Pcs. per card	Std. Pkg.	OEM Pkg.	Screw Size	Weight Pounds
4	2 <sup>1</sup> / <sub>8</sub> × 1½	1188 DP4 CHR	1188 004 CHR	2	10	---	10	¼
6	3 × 1¾	1188 DP6 CHR	1188 006 CHR	1	5	---	10	½
8	4 × 2 <sup>1</sup> / <sub>8</sub>	1188 DP8 CHR	1188 008 CHR	1	5	25	¼	¾
10	5 × 2 <sup>3</sup> / <sub>8</sub>	-----	1188 010 CHR	-	1	10	¼	1½
12	6 × 3	-----	1188 012 CHR	-	1	10	5/16	2½

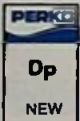

## OPEN BASE CLEAT FIG. 1210

Chrome Plated Zinc  
Zinc Plated Steel Studs

### ORDERING INFORMATION

Length Overall Inches	Dimensions Base Inches	Catalog Number	Std. Pkg.	OEM Pkg.	Stud Size	Weight Ounces
4	2 <sup>1</sup> / <sub>8</sub> × 1½	1210 004 CHR	10	50	12-24 × 1¼	5½
6	3 × 1¾	1210 006 CHR	10	30	¼-20 × 2	8
8	4 × 2 <sup>1</sup> / <sub>8</sub>	1210 008 CHR	5	30	¼-20 × 2	12½

Fig. 1210

## OPEN BASE CLEAT FIG. 530

### Plain Aluminum

#### ORDERING INFORMATION

Length Overall Inches	Dimensions Base Inches	Standard Pkg.-1 pc.	Screw Size	Weight Pounds
8	4 x 2¼	530 008 ALU	½	1⅛
10	4½ x 3	530 010 ALU	½	1¾
12	6½ x 2⅞	530 012 ALU	⅝	3½
15	7 x 3¼	530 015 ALU	¾	4⅞



Fig. 530

## CLEAT FIG. 545

### Plain Aluminum

Length Overall Inches	Dimensions Base Inches	ORDERING INFORMATION		Display Pkg.-5 bags Pcs. per bag	Std. Pkg.	Screw Size	Weight Ounces
		Display Pkg.	Standard Pkg.				
3	1½ x ⅝	545 DP3 ALU	545 003 ALU	2	10	8	1½
4	1⅝ x ¾	545 DP4 ALU	545 004 ALU	2	10	10	2
5	2 x ⅞	545 DP5 ALU	545 005 ALU	2	10	¼	3
6	2¼ x ⅞	545 DP6 ALU	545 006 ALU	**1	10	¼	4
*8	2⅝ x 1⅞	545 DP8 ALU	545 008 ALU	**1	10	¼	5
*10	3⅝ x 1½	-----	545 010 ALU	—	5	⅝	9
*12	4 x 1½	-----	545 012 ALU	—	5	⅝	14



Fig. 545



\*These Sizes are Open Base, Balance of Sizes are Closed Base.

\*\*Display Pkg.-10 bags.



## CLEAT FIG. 544

### Cast Bronze Polished or Chrome Plated

#### ORDERING INFORMATION

Length Overall Inches	Dimensions Base Inches	Chrome Plated Bronze	Polished Bronze	Chrome Plated Bronze	Display Pkg.-5 cds. Pcs. per card	Std. Pkg.	Screw Size	Weight Pounds
		Display Pkg.	Standard Pkg.	Standard Pkg.				
3	1½ x ⅝	544 DP3 CHR	544 003 POL	544 003 CHR	2	10	8	⅛
4	1⅝ x ¾	544 DP4 CHR	544 004 POL	544 004 CHR	1	5	10	¼
5	2 x ⅞	-----	544 005 POL	544 005 CHR	—	5	¼	¾
6	2¼ x ⅞	-----	544 006 POL	544 006 CHR	—	5	¼	1⅞
*8	2⅝ x 1½	-----	544 008 POL	**544 008 CHR	—	1	¼	2

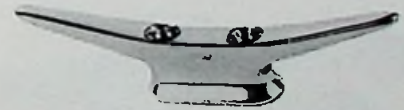

Fig. 544



\*This Size is Open Base, Balance of Sizes are Closed Base.

\*\*O.E.M. Pkg.-10 pcs.



## CHROMALEX® CLEATS

PATENT NO. 3,828,714

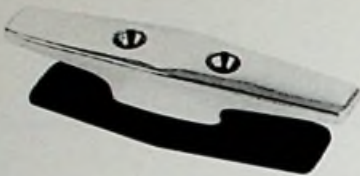

Fig. 1305

### CLOSED BASE CLEAT FIG. 1305

**Chrome Plated Zinc  
Black Plastic Base**

#### ORDERING INFORMATION

Length Overall Inches	Max. Rope Size Inches	Display Pkg.	Standard Pkg.	Display Pkg.-5 cds. Pcs. per card	Std. Pkg.	OEM Pkg.	Screw Size	Weight Ounces
4½	¾	1305 DP1 CHR	1305 001 CHR	2	10	50	10	5
6	½	1305 DP2 CHR	1305 002 CHR	1	5	50	¼	10

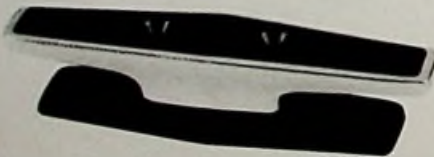

Fig. 1405

### CLOSED BASE CLEAT FIG. 1405

**Chrome Plated Zinc  
Black Plastic Base and Insert**

#### ORDERING INFORMATION

Length Overall Inches	Max. Rope Size Inches	Display Pkg.	Standard Pkg.	Display Pkg.5 cds. Pcs. per card	Std. Pkg.	OEM Pkg.	Screw Size	Weight Ounces
4½	¾	1405 DP1 CHR	1405 001 CHR	2	10	50	10	5
6	½	1405 DP2 CHR	1405 002 CHR	1	5	50	¼	10



## CHROMALEX® CLEATS

PATENT NO. 3,828,714

### CLOSED BASE CLEAT FIG. 1315

Chrome Plated Zinc  
Black Plastic Base  
Zinc Plated Steel Studs, Nuts and Washers



Fig. 1315

#### ORDERING INFORMATION

Length Overall Inches	Max. Rope Size Inches	Standard Pkg.	Std. Pkg.	OEM Pkg.	Stud Size	Weight Ounces
4½	¾	1315 001 CHR	10	50	12-24 x 1½	6½
6	½	1315 002 CHR	5	40	¼ x 1½	12

### CLOSED BASE CLEAT FIG. 1415

Chrome Plated Zinc  
Black Plastic Base and Insert  
Zinc Plated Steel Studs, Nuts and Washers



Fig. 1415

#### ORDERING INFORMATION

Length Overall Inches	Max. Rope Size Inches	Standard Pkg.	Std. Pkg.	OEM Pkg.	Stud Size	Weight Ounces
4½	¾	1415 001 CHR	10	50	12-24 x 1½	6½
6	½	1415 002 CHR	5	40	¼ x 1½	12

## CHROMALEX® CLEATS

PATENT NO. 3,828,714



Fig. 1306

### OPEN BASE CLEAT FIG. 1306

Chrome Plated Zinc  
Black Plastic Base

#### ORDERING INFORMATION

Length Overall Inches	Max. Rope Size Inches	Display Pkg.	Standard Pkg.	Display Pkg.-5 cds. Pcs. per card	Std. Pkg.	OEM Pkg.	Screw Size	Weight Ounces
4½	¾	1306 DP1 CHR	1306 001 CHR	2	10	50	10	4
6	½	1306 DP2 CHR	1306 002 CHR	1	5	50	¼	8½

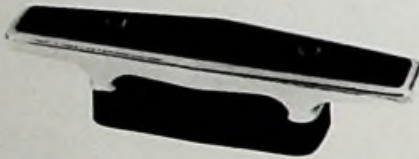

Fig. 1406

### OPEN BASE CLEAT FIG. 1406

Chrome Plated Zinc  
Black Plastic Base and Insert

#### ORDERING INFORMATION

Length Overall Inches	Max. Rope Size Inches	Display Pkg.	Standard Pkg.	Display Pkg.-5 cds. Pcs. per card	Std. Pkg.	OEM Pkg.	Screw Size	Weight Ounces
4½	¾	1406 DP1 CHR	1406 001 CHR	2	10	50	10	4
6	½	1406 DP2 CHR	1406 002 CHR	1	5	50	¼	8½
8	¾		1406 003 CHR	-	1	50	¼	11

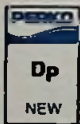

Fig. 573

### OPEN BASE CLEAT FIG. 573

Chrome Plated Bronze  
Black Plastic Base

#### ORDERING INFORMATION

Length Overall Inches	Dimensions Base Inches	Max. Rope Size Inches	Std. Pkg.-5 pcs. OEM Pkg.-25 pcs.	Screw Size	Weight Ounces
6	3⅝ x 7/8	½	573 006 CHR	¼	9

## CHROMALEX® CLEATS

PATENT NO. 3,828,714

### OPEN BASE CLEAT FIG. 1316

Chrome Plated Zinc  
Black Plastic Base  
Zinc Plated Steel Studs, Nuts and Washers



Fig. 1316

#### ORDERING INFORMATION

Length Overall Inches	Max. Rope Size Inches	Standard Pkg.	Std. Pkg.	OEM Pkg.	Stud Size	Weight Ounces
4½	¾	1316 001 CHR	10	50	12-24 x 1½	5
6	½	1316 002 CHR	5	40	¼ x 1½	10½

### OPEN BASE CLEAT FIG. 1416

Chrome Plated Zinc  
Black Plastic Base and Insert  
Zinc Plated Steel Studs, Nuts and Washers



Fig. 1416

#### ORDERING INFORMATION

Length Overall Inches	Max. Rope Size Inches	Standard Pkg.	Std. Pkg.	OEM Pkg.	Stud Size	Weight Ounces
4½	¾	1416 001 CHR	10	50	12-24 x 1½	5
6	½	1416 002 CHR	5	40	¼ x 1½	10½
8	¾	1416 003 CHR	1	30	¼ x 1½	13



Fig. 546

## BOW CHOCKS FIG. 546

Chrome Plated Bronze

### ORDERING INFORMATION

Max. Rope Size Inches	Length Overall Inches	Width Inches	Display Pkg.-5 cds. 1 Pair per card	Standard Pkg.-5 prs.	Screw Size	Weight per Pair Pounds
5/8	4	3/4	546 DP4 CHR	546 004 CHR	10	1/2
7/8	5	7/8	546 DP5 CHR	546 005 CHR	10	1



Fig. 1223

## SKENE BOW CHOCKS FIG. 1223

Chrome Plated Zinc

### ORDERING INFORMATION

Max. Rope Size Inches	Length Overall Inches	Width Inches	Display Pkg.-5 cds. 1 Pair per card	Std. Pkg.-5 prs. OEM Pkg.-50 prs.	Screw Size	Weight per Pair Ounces
1/2	3 1/2	7/8	1223 DP CHR	1223 000 CHR	8	4



Fig. 160

## SKENE BOW CHOCKS FIG. 160

Chrome Plated Bronze

### ORDERING INFORMATION

Max. Rope Size Inches	Length Overall Inches	Width Inches	Catalog Number	Std. Pkg. Prs.	Screw Size	Weight per Pair Pounds
3/4	5 1/8	1 1/8	160 002 CHR	5	10	1 1/2
7/8	7 1/4	1 3/8	160 003 CHR	1	5/16	4



## STRAIGHT CHOCK FIG. 119

Chrome Plated Bronze



Fig. 119

### ORDERING INFORMATION

Max. Rope Size Inches	Length Overall Inches	Width Inches	Display Pkg.-5 cds. 1 Pc. per card	Standard Pkg.	Std. Pkg.	Screw Size	Weight Each Pounds
3/4	4	7/8	119 DP4 CHR	119 004 CHR	5	8	1/4
1	6	1 1/8	-----	119 006 CHR	1	12	3/4



## STRAIGHT CHOCKS FIG. 1230

Chrome Plated Zinc



Fig. 1230

### ORDERING INFORMATION

Max. Rope Size Inches	Length Overall Inches	Width Inches	Display Pkg.-10 cds. 1 Pair per card	Std. Pkg.-10 prs. OEM Pkg.-50 prs.	Screw Size	Weight per Pair Ounces
3/4	4	7/8	1230 DP CHR	1230 000 CHR	8	6



## CHROMALEX® CHOCKS

PATENT NO. 3,828,714

## SKENE CHOCKS FIG. 1307

Chrome Plated Zinc  
Black Plastic Base



Fig. 1307

### ORDERING INFORMATION

Max. Rope Size Inches	Length Overall Inches	Width Inches	Display Pkg.-5 cds. 1 Pair per card	Standard Pkg.-5 prs.	OEM Pkg. Prs.	Screw Size	Weight per Pair Ounces
3/8	3 1/2	7/8	1307 DP1 CHR	1307 001 CHR	50	10	5
1/2	5	1 1/4	1307 DP2 CHR	1307 002 CHR	25	1/4	12



## STRAIGHT CHOCKS FIG. 1308

Chrome Plated Zinc  
Black Plastic Base



Fig. 1308

### ORDERING INFORMATION

Max. Rope Size Inches	Length Overall Inches	Width Inches	Display Pkg.-5 cds. 1 Pair per card	Standard Pkg.-5 prs.	OEM Pkg. Prs.	Screw Size	Weight per Pair Ounces
3/8	3 1/2	7/8	1308 DP1 CHR	1308 001 CHR	50	10	5
1/2	5	1 1/4	1308 DP2 CHR	1308 002 CHR	25	1/4	12

## MOORING BITTS FIGS. 608 & 1219

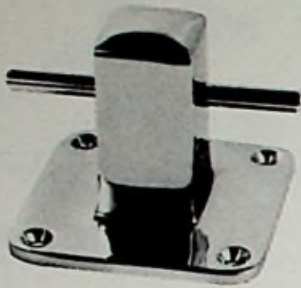

Fig. 608 — Chrome Plated Bronze  
Fig. 1219 — Chrome Plated Zinc

Fig. 608 — Chrome Plated Bronze  
Fig. 1219 — Chrome Plated Zinc

Hollow

### ORDERING INFORMATION

Dimensions	Height	Fig. 608	Fig. 1219	Bolt	Weight
Base	Inches	Standard	Standard	Size	Pounds
Inches	Inches	Pkg.-1 pc.	Pkg.-1 pc.		
3 x 3	2½	608 001 CHR	-----	10	7/8
4¼ x 4¼	3½	608 002 CHR	-----	¼	17/8
5 x 5	4¾	608 02A CHR	1219 02A CHR	3/8	3½
6 x 6	5	608 003 CHR	-----	3/8	4½

## COMBINATION BITT AND ROPE DECK PIPES FIGS. 431 & 1237

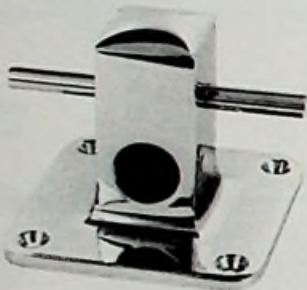

Fig. 431 — Chrome Plated Bronze  
Fig. 1237 — Chrome Plated Zinc

Fig. 431 — Chrome Plated Bronze  
Fig. 1237 — Chrome Plated Zinc

Hollow

### ORDERING INFORMATION

Dimensions	Opening	Height	Fig. 431	Fig. 1237	Bolt	Weight
Base	For Rope	Inches	Standard	Standard	Size	Pounds
Inches	Size	Inches	Pkg.-1 pc.	Pkg.-1 pc.		
Inches	Inches	Inches				
4¼ x 4¼	¾	3½	431 002 CHR	-----	¼	1¾
5 x 5	1	4¾	431 02A CHR	1237 02A CHR	3/8	3¼
6 x 6	1	5	431 003 CHR	-----	3/8	4

## HAWSE HOLE PLATE FIG. 1250

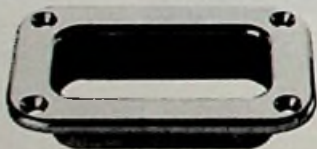

Fig. 1250

Chrome Plated Zinc

### ORDERING INFORMATION

Dimensions	Dimensions	Length	Std. Pkg.-1 pc.	Screw	Weight
Outside	Inside	Spigot	OEM Pkg.-10 pcs.	Size	Pounds
Inches	Inches	Inches			
3⅝ x 5⅝	2⅛ x 4⅛	1	1250 000 CHR	¼	¾

## HAWSE HOLE PLATE FIG. 752

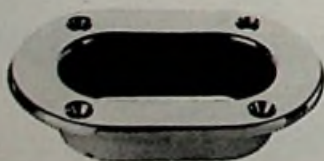

Fig. 752

Forged Bronze  
Plain or Chrome Plated

### ORDERING INFORMATION

Dimensions	Dimensions	Length	Plain	Chrome Plated	Screw	Weight
Outside	Inside	Spigot	Bronze	Bronze	Size	Pounds
Inches	Inches	Inches	Standard	Std. Pkg.-1 pc.		
Inches	Inches	Inches	Pkg.-1 pc.	OEM Pkg.-10 pcs.		
4¼ x 6	2⅛ x 4⅛	1¼	752 000 PLB	752 000 CHR	¼	1½

## ROPE AND CHAIN DECK PIPE FIG. 750

**Chrome Plated Forged Bronze**

The Cover Has a Hook for Hanging Chain and a Stainless Steel Cable Retainer.



Fig. 750

Opening For Chain Size Inches	Dimensions Flange Inches	Height Overall Inches	ORDERING INFORMATION			
			Display Pkg.-5 cds. 1 Pc. per card	Std. Pkg.-5 pcs. OEM Pkg.-10 pcs.	Screw Size	Weight Pounds
3/8	5/4 x 4	1 3/8	750 DP CHR	750 000 CHR	8	2

Spare Cover with Hook and Cable, Cat. No. 750 000 99A.

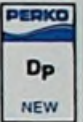

## ROPE DECK PIPE FIG. 1057

**U.V. Stabilized, Fiber Reinforced, High Impact Black or White Plastic**

Hinged, Snap-Down Cover



Fig. 1057

Color	Max. Rope Size Inches	O.D. Flange Inches	ORDERING INFORMATION				
			Display Pkg.-5 cds. 1 Pc. per card	Standard Pkg.-5 pcs.	OEM Pkg.	Screw Size	Weight Ounces
Black	7/8	3 3/4	1057 DP BLK	1057 000 BLK	25	8	3 3/4
White	7/8	3 3/4	1057 DP WHT	1057 000 WHT	25	8	3 3/4



## ROPE DECK PIPE FIG. 741

**Chrome Plated Bronze**

### ORDERING INFORMATION

Max. Rope Size Inches	O.D. Flange Inches	Standard Pkg.-1 pc.	OEM Pkg.	Screw Size	Weight Pounds
5/8	3	741 000 CHR	10	8	3/4
1	4 1/4	741 001 CHR	—	8	1 1/2



Fig. 741

Spare No. 0 Cap with Chain, Cat. No. 741 000 99A.  
Spare No. 1 Cap with Chain, Cat. No. 741 001 99A.

## ROPE DECK PIPE FIG. 757

**Chrome Plated Zinc**

### ORDERING INFORMATION

Max. Rope Size Inches	O.D. Flange Inches	Display Pkg.-5 cds. 1 Pc. per card	Std. Pkg.-5 pcs. OEM Pkg.-10 pcs.	Screw Size	Weight Pounds
1	3 3/8	757 DP CHR	757 000 CHR	8	1/2



Fig. 757





## ANCHOR CHOCKS FIGS. 903

Chrome Plated Bronze  
Polished or Burnished

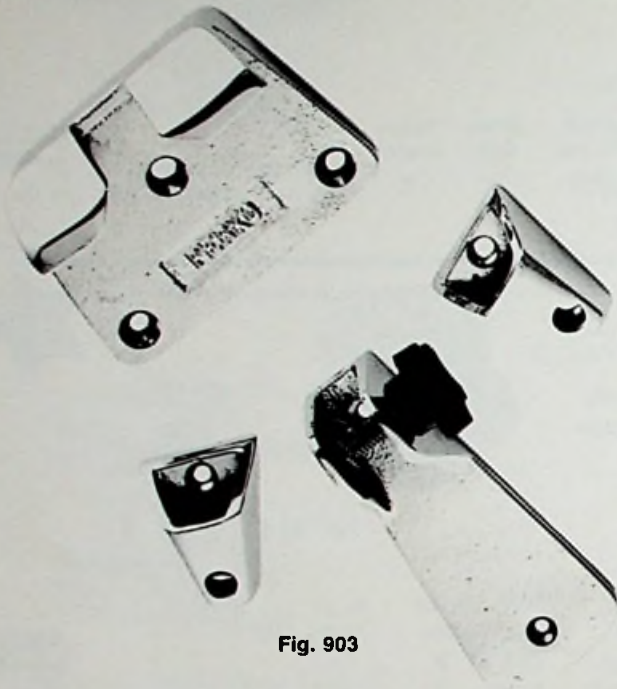

Fig. 903

Size No. 1 Fits		
Fortress™ Models FX7-FX16	Danforth® Models	
	H <sup>o</sup> 500	T™ 570
U.S. Anchor Mfg., INC. Models 2½, 4, 8, 13	H <sup>o</sup> 960	T™ 1200
	H <sup>o</sup> 1500	T™ 1800
	S <sup>o</sup> 160	T™ 2500
	S <sup>o</sup> 300	T™ 3000
	S <sup>o</sup> 600	D™ 375
	S <sup>o</sup> 920	D™ 750
	S <sup>o</sup> 1300	D™ 1150
	VSB™ 900	D™ 1650
	VSB™ 13000	
	VSB™ 1900	
Size No. 2 Fits		
Fortress™ Models FX23-FX55	Danforth® Models	
	H <sup>o</sup> 1800	T™ 4000
	H <sup>o</sup> 3100	T™ 6000
	H <sup>o</sup> 3600	T™ 7000
	D™ 2000	
	D™ 2500	
U.S. Anchor Mfg., INC. Models 18 & 22	S <sup>o</sup> 1600	
	S <sup>o</sup> 2000	
	S <sup>o</sup> 3000	
	VSB™ 2500	
	VSB™ 3600	

### ORDERING INFORMATION

Polished Chrome Plated Bronze	Polished Chrome Plated Bronze	Burnished Chrome Plated Bronze	Burnished Chrome Plated Bronze	Screw Size	Weight Per Set Pounds
Display Pkg.-5 cds. 1 Set per card	Standard Pkg.-5 sets	Display Pkg.-5 cds. 1 Set per card	Standard Pkg.-5 sets		
903 DP1 CHR	903 001 CHR	903 DP1 BUR	903 001 BUR	10	2
903 DP2 CHR	903 002 CHR	903 DP2 BUR	903 002 BUR	10	2¼

### SPARE PARTS ORDERING INFORMATION

To Specify Size Replace the Sixth Digit with the Size Number (i.e. 903 001 99A or 903 B01 99A).



Spare Polished Chrome Shank Support, Cat. No. 903 000 99A.  
Spare Pair, Polished Chrome Fluke Supports, Cat. No. 903 000 99B.  
Spare Polished Chrome Crown Support, Cat. No. 903 000 99C.  
Spare Knob, Cat. No. 1144 A00 BLK.

Spare Burnished Chrome Shank Support, Cat. No. 903 B00 99A.  
Spare Pair, Burnished Chrome Fluke Supports, Cat. No. 903 B00 99B.  
Spare Burnished Chrome Crown Support, Cat. No. 903 B00 99C.



Fig. 759

## DOCK LINE SPRING FIG. 759

Galvanized Spring Steel

### ORDERING INFORMATION

For Rope Size Inches	Length Overall Inches	O.D. Inches	Compression Inches	Standard Pkg.-5 pcs.	Weight Pounds
½	10	1½	4½	759 001 ZNC	7/8

**NOTE: The Bow Eyes and Transom Eyes Illustrated on this Page are not Designed to Bear the Weight of the Vessel and Therefore Should Not Be Used For Lifting.**

## BOW EYE FIG. 237

**Non-Magnetic 300 Series Stainless Steel Shank  
Stainless Steel Nuts & Washers**

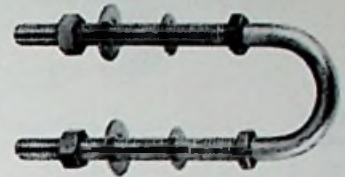

Fig. 237

### ORDERING INFORMATION

Length Shank Inches	O.D. Shank Inches	I.D. Eye Inches	Length Thread Inches	Display Pkg.-10 bags 1 Pc. per bag	Standard Pkg. 237 001 STS	Std. Pkg. 10	OEM Pkg. 25	Weight Ounces 4	Safe Working Load Pounds 1800
3	5/16	1	3	237 DP1 STS	237 001 STS	10	25	4	1800
6	5/16	1	6	237 DP2 STS	237 002 STS	10	—	5 1/2	1800
3	3/8	1 1/8	3	*237 DP3 STS	237 003 STS	5	25	5	3000
3/4	1/2	1 1/2	3/4	*237 DP4 STS	237 004 STS	5	—	12	4600

\*Display Pkg.-5 bags, 1 Pc. per bag.



## BOW EYE FIG. 1235

**Chrome Plated Zinc Eye  
Zinc Plated Steel "U" Bolt, Nuts & Washers**

**Safe Working Load 2000 Pounds**

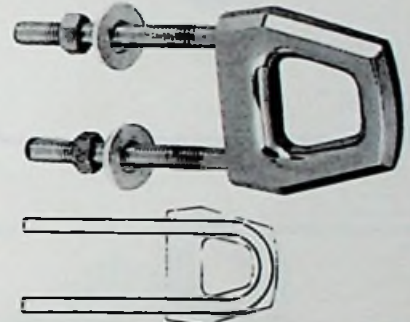

Fig. 1235

### ORDERING INFORMATION

Length Shank Inches	O.D. Shank Inches	I.D. Eye Inches	Length Thread Inches	Display Pkg.-10 cds. 1 Pc. per card	Standard Pkg.-10 pcs.	Weight Ounces
3	5/16	1	2 3/4	1235 DP CHR	1235 000 CHR	11



## TRANSOM EYE FIG. 236

**Non-Magnetic 300 Series Stainless Steel Shank  
Stainless Steel Finishing Plate, Nuts & Washers**

**For Use as Towing or Lashing Eye**

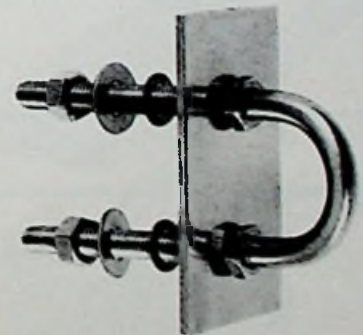
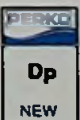

Fig. 236

### ORDERING INFORMATION

Length Shank Inches	O.D. Shank Inches	I.D. Eye Inches	Dimensions Plate Inches	Display Pkg.-5 bags 1 Pc. per bag	Standard Pkg.	Std. Pkg. 10	Weight Ounces 6	Safe Working Load Pounds 1800
3	5/16	1	3 x 1 3/4	*236 DP1 STS	236 001 STS	10	6	1800
3	3/8	1 1/8	3 x 1 3/4	236 DP3 STS	236 003 STS	5	10	3000
3/4	1/2	1 1/2	4 x 1 3/4	236 DP4 STS	236 004 STS	5	14 1/2	4600

\*Display Pkg.-10 bags, 1 Pc. per bag.



**IMPORTANT NOTE: The Safe Working Load Information Given for the Items Above is Based on a Straight Axial Pull. This Information Would Not Apply in Cases Where Installation or Use Creates Angular Loading Since These Variations Make it Impracticable to Offer Accurate Test Data.**

## WATER SKI TOWING HOOK FIG. 863

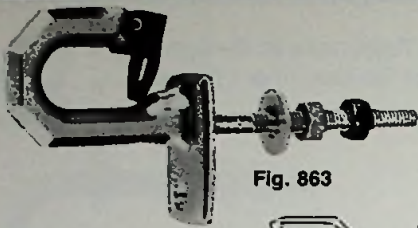
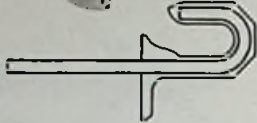

Fig. 863

**Chrome Plated Zinc Body  
Zinc Plated Steel Shank, Nuts & Washers**

### ORDERING INFORMATION

Length Overall Inches	Length Shank Inches	O.D. Shank Inches	Length Thread Inches	Display Pkg.-5 cds. 1 Pc. per card	Std. Pkg.-5 pcs. OEM Pkg.-25 pcs.	Weight Ounces
6	3¼	5/16	2½	863 DP CHR	863 000 CHR	10



## LIFTING EYE FIG. 429

**Chrome Plated Manganese Bronze  
Integral Flange**

**Safe Working Load 3000 Pounds**

### ORDERING INFORMATION



Fig. 429

For Rod Inches	I.D. Eye Inches	O.D. Eye Inches	O.D. Base Inches	Standard Pkg.-1 pc.	Screw Size	Weight Ounces
5/8	1½	2¼	2¼	429 000 CHR	8	19

## LIFTING EYE FIG. 430

**Chrome Plated Manganese Bronze  
Loose Flange**

**Safe Working Load 3000 Pounds**

### ORDERING INFORMATION



Fig. 430

For Rod Inches	I.D. Eye Inches	O.D. Eye Inches	O.D. Flange Inches	Standard Pkg.-1 pc.	Screw Size	Weight Ounces
5/8	1½	2¼	2½	430 000 CHR	8	17

## LIFTING EYE AND CLEAT FIG. 434

**Chrome Plated Manganese Bronze**

**Safe Working Load 4000 Pounds**

### ORDERING INFORMATION



Fig. 434

For Rod Inches	I.D. Eye Inches	Length Overall Inches	Dimensions Base Inches	Standard Pkg.-1 pc.	Screw Size	Weight Ounces
5/8	1 1/16	5 1/8	3 1/2 x 2 1/2	434 000 CHR	10	18

**IMPORTANT NOTE: The Safe Working Load Information Given for the Items Above is Based on a Straight Axial Pull. This Information Would Not Apply in Cases Where Installation or Use Creates Angular Loading Since These Variations Make It Impracticable to Offer Accurate Test Data.**

## STEP PLATE FIG. 1043

Chrome Plated Bronze Frames  
Soft Black Plastic Pads

### ORDERING INFORMATION

Dimensions Inches	Standard Pkg.-6 pcs.	Screw Size	Weight Ounces
8¾ x 3¼	1043 001 CHR	6	8
11½ x 5¾	1043 002 CHR	8	12

Spare Pad for Size No. 1, Cat. No. 1050 DP1 BLK.  
Spare Pad for Size No. 2, Cat. No. 1050 DP2 BLK.



Fig. 1043

## STEP PLATE FIG. 1325

Chrome Plated Zinc Frames  
Soft Black Plastic Pads

### ORDERING INFORMATION

Dimensions Inches	Display Pkg.-5 cds. 2 Pcs. per card	Standard Pkg.-10 pcs.	OEM Pkg.	Screw Size	Weight Ounces
8¾ x 2¼	1325 DP0 CHR	1325 000 CHR	50	8	5
8¾ x 3¼	1325 DP1 CHR	1325 001 CHR	50	8	8
11½ x 5¾	1325 DP2 CHR	1325 002 CHR	25	8	12

Spare Pad for Size No. 0, Cat. No. 1050 DP0 BLK. Spare Pad for Size No. 2, Cat. No. 1050 DP2 BLK.  
Spare Pad for Size No. 1, Cat. No. 1050 DP1 BLK.



Fig. 1325

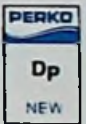

## FIXED STEPS FIGS. 351 & 501

Chrome Plated Bronze

### ORDERING INFORMATION

Dimensions Step Inches	Dimensions Bracket Inches	Standard Pkg.-1 pc.	Bolt Size	Weight Pounds
6 x 4¼	6 x 2	351 000 CHR	⅝ R.H.	1½
11 x 4½	11 x 2	501 000 CHR	⅝ R.H.	2½



Fig. 351

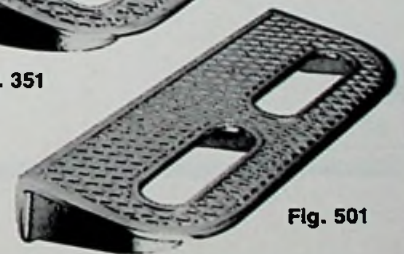

Fig. 501

## FOLDING STEP FIG. 344

Chrome Plated Bronze

Stainless Steel Spring Holds Step in Open or Closed Position.

### ORDERING INFORMATION

Dimensions Step Inches	Dimensions Bracket Inches	Projection Folded Inches	Display Pkg.-5 cds. 1 Pc. per card	Standard Pkg.-5 pcs.	Bolt Size	Weight Pounds
4⅞ x 2¼	4¼ x 1¾	1¾	344 000 CHR	344 000 CHR	⅝ R.H.	1½

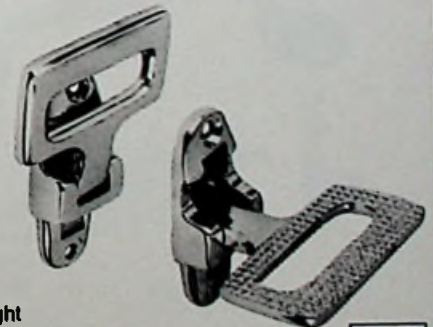

Fig. 344



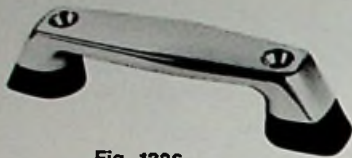

Fig. 1336

## CHROMALEX® HANDLE FIG. 1336

Chrome Plated Zinc  
Black Plastic Bases

### ORDERING INFORMATION

Length Overall Inches	Length Inside Inches	Height Inside Inches	Display Pkg.-5 cds. 2 Pcs. per card	Std. Pkg.-10 pcs. OEM Pkg.-50 pcs.	Screw Size	Weight Ounces
6¼	3½	1	1336 DP CHR	1336 000 CHR	¼	10



Fig. 1346

## CHROMALEX® HANDLE FIG. 1346

Chrome Plated Zinc  
Black Plastic Bases

### ORDERING INFORMATION

Length Overall Inches	Length Inside Inches	Height Inside Inches	Std. Pkg.-10 pcs. OEM Pkg.-50 pcs.	Stud Size	Weight Ounces
6¼	3½	1	1346 000 CHR	¼-20x1½	10

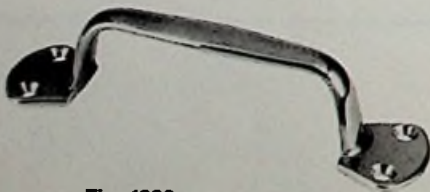

Fig. 1222

## HANDLE FIG. 1222

Chrome Plated Zinc

### ORDERING INFORMATION

Length Overall Inches	Length Inside Inches	Height Inside Inches	Display Pkg.-5 cds. 2 Pcs. per card	Std. Pkg.-10 pcs. OEM Pkg.-100 pcs.	Screw Size	Weight Ounces
5¾	3⅝	1¼	1222 DP CHR	1222 000 CHR	8	3½





## HANDLE FIG. 1231

Chrome Plated Zinc



Fig. 1231

### ORDERING INFORMATION

Length Overall Inches	Length Inside Inches	Height Inside Inches	Display Pkg.-5 cds. 2 Pcs. per card	Std. Pkg.-10 pcs. OEM Pkg.-50 pcs.	Screw Size	Weight Ounces
6	3½	1⅝	1231 DP CHR	1231 000 CHR	¼	7¼



## HANDLE FIG. 775

Chrome Plated Bronze



Fig. 775

### ORDERING INFORMATION

Length Overall Inches	Length Inside Inches	Height Inside Inches	Display Pkg.-5 cds. 2 Pcs. per card	Standard Pkg.-10 pcs.	OEM Pkg.	Screw Size	Weight Ounces
4¼	2½	7/8	775 DP1 CHR	775 001 CHR	50	6	2
5¾	3⅝	1⅜	775 DP2 CHR	775 002 CHR	50	8	4



## AXE BRACKETS FIG. 325

Stainless Steel



Fig. 325

### ORDERING INFORMATION

For Blade Width Inches	Standard Pkg.-10 sets	Socket Screw Size	Bracket Screw Size	Weight Per Set Ounces
6	325 000 STS	10 R.H.	6	4½

## FLUSH FLAG POLE SOCKETS FIGS. 218 & 219



**Bow**  
Fig. 218



**Stern**  
Fig. 219

**Chrome Plated Bronze**

**Fig. 218 — Bow Socket**  
**Fig. 219 — Stern Socket**

### ORDERING INFORMATION

I.D. Socket Inches	O.D. Flange Inches	Depth Socket Inches	Fig. 218 Standard Pkg.-1 pc.	Fig. 219 Standard Pkg.-1 pc.	Screw Size	Weight Ounces
3/4	2	1 1/2	218 001 CHR	219 001 CHR	8	4 1/2
1	2 3/8	1 3/4	218 002 CHR	219 002 CHR	8	5
1 1/4	2 5/8	2	218 003 CHR	219 003 CHR	8	9



**Bow**  
Fig. 220



**Stern**  
Fig. 221

## UPRIGHT FLAG POLE SOCKETS FIGS. 220 & 221

**Chrome Plated Bronze**

**Fig. 220 — Bow Socket**  
**Fig. 221 — Stern Socket**

### ORDERING INFORMATION

I.D. Socket Inches	O.D. Base Inches	Height Overall Inches	Fig. 220 Display Pkg.-5 cds. 1 Pc. per card	Fig. 220 Standard Pkg.-1 pc.	Fig. 221 Display Pkg.-5 cds. 1 Pc. per card	Fig. 221 Standard Pkg.-1 pc.	Screw Size	Weight Ounces
3/4	2 1/8	1 3/4	220 DP1 CHR	*220 001 CHR	221 DP1 CHR	*221 001 CHR	8	5 1/4
1	2 1/2	2	-----	220 002 CHR	-----	221 002 CHR	8	6 3/4
1 1/4	2 3/4	2 1/8	-----	220 003 CHR	-----	221 003 CHR	8	10 3/4

\*Std. Pkg.-5 pcs.

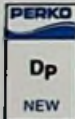

**Fig. 1302**

## CLAMP-ON FLAG POLE SOCKET FIG. 1302

**Chrome Plated Zinc**  
**Black Plastic Knob**

For Rail Sizes 3/4 or 1 Inch.

### ORDERING INFORMATION

I.D. Socket Inches	Dimensions Bracket Inches	Display Pkg.-5 cds. 1 Pc. per card	Std. Pkg.-5 pcs. OEM Pkg.-50 pcs.	Weight Ounces
3/4	2 x 1 3/4	1302 DP CHR	1302 000 CHR	11



## FLAG STAFF FIG. 495

**Chrome Plated Zinc Base and Top**  
**Anodized Aluminum Tube**

Sizes 2 and 3 For Use With  
Fig. 1302 Clamp-On Socket Only

### ORDERING INFORMATION

O.D. Base Inches	Length Overall Inches	Display Pkg.-5 bags 1 Pc. per bag	Standard Pkg.-5 pcs.	Weight Ounces
1/2	14	495 DP1 CHR	495 001 CHR	3
3/4	14	495 DP2 CHR	495 002 CHR	4
3/4	18	495 DP3 CHR	495 003 CHR	5

**Fig. 495**

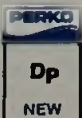

## GRAB RAIL POSTS FIGS. 1297 & 1298

Chrome Plated Zinc

Fig. 1297 — End Post  
Fig. 1298 — Center Post

Hollow, For 3/4 Inch O.D. Tubing



Fig. 1297 End Post



Fig. 1298 Center Post

### ORDERING INFORMATION

Height Overall Inches	O.D. Base Inches	Fig. 1297 Standard Pkg.-4 pcs.	Fig. 1298 Standard Pkg.-2 pcs.	Screw Size	Weight Ounces
1 3/4	1 5/8	1297 000 CHR	1298 000 CHR	6	2 3/4

## GRAB RAIL POSTS FIGS. 380 & 380A

Chrome Plated Bronze

Fig. 380 — End Post  
Fig. 380A — Center Post

Hollow, For 1 Inch O.D. Tubing



Fig. 380 End Post



Fig. 380A Center Post

### ORDERING INFORMATION

Height Overall Inches	O.D. Base Inches	Fig. 380 Standard Pkg.-1 pc.	Fig. 380A Standard Pkg.-1 pc.	Screw Size	Weight Ounces
3 3/8	2 1/2	380 000 CHR	380 A00 CHR	8	10

## GRAB RAIL POSTS FIGS. 413 & 413A

Chrome Plated Bronze

Fig. 413 — End Post  
Fig. 413A — Center Post

Hollow, For 1 Inch O.D. Tubing  
with .035 Inch Wall Thickness



Fig. 413 End Post



Fig. 413A Center Post

### ORDERING INFORMATION

Height Overall Inches	Dimensions		Standard Pkg.-1 pc.	Screw Size	Weight Ounces
	Base Inches				
2 1/4	3 x 2		413 000 CHR	8	10
2 1/4	2 3/4 x 1 1/2		413 A00 CHR	8	7 1/4

## ANODIZED ALUMINUM TUBING FIG. 497



Fig. 497

### ORDERING INFORMATION

O.D. Inches	Length Feet	Standard Pkg.-3 pcs.	Weight Ounces
3/4	6	497 000 ALU	10



## POLISHED 18-8 STAINLESS STEEL TUBING FIG. 498



Fig. 498

### ORDERING INFORMATION

O.D. Inches	Length Feet	B & S Gauge	Standard Pkg.-3 pcs.	Weight Pounds
1	6	20	498 000 STS	2 1/4



## FITTINGS FOR WOOD GUARD RAILS FIGS. 180 & 185

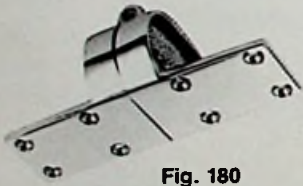

Fig. 180

### Chrome Plated Bronze

Hinge — Fig. 180

Latch — Fig. 185



Fig. 185

### ORDERING INFORMATION

For Rail Dimensions Inches	Length Overall Inches	Fig. 180 Standard Pkg.-1 pc.	Fig. 185 Standard Pkg.-1 pc.	Screw Size	Weight Pounds
2 3/8 x 1 3/8	5	180 001 CHR	185 001 CHR	8	3/4
2 7/8 x 1 1/4	5 1/2	180 002 CHR	185 002 CHR	8	1

## TRANSOM PLATES FIG. 1224

Chrome Plated Zinc  
Soft Black Plastic Pad



Fig. 1224

### ORDERING INFORMATION

Length Overall Inches	O.D. Pad Inches	Display Pkg.-10 cds. 1 Pr. per card	Screw Size	Weight per Pair Ounces
3 1/2	1 7/8	1224 DP CHR	8	2 3/4



## RING BUOY HOLDER FIG. 1017

**Brass**  
**Plain or Chrome Plated**



Fig. 1017

### ORDERING INFORMATION

Width Mounting Plate Inches	Height Overall Inches	Chrome Plated Brass		Plain Brass		Screw Size	Weight Pounds
		Display Pkg.-5 bags 1 Pc. per bag		Standard Pkg.-5 pcs.	OEM Pkg.-20 pcs.		
3	4½	1017 DP CHR		1017 000 PLB	1017 000 CHR	8	½



## BOAT HOOK HOLDERS FIG. 492

**Stainless Steel**



Fig. 492

### ORDERING INFORMATION

Maximum Pole O.D. Inches	Length Inches	Width Inches	Display Pkg.-10 bags 1 Pr. per bag	OEM Pkg.-50 prs.	Screw Size	Weight per Pair Ounces
1½	3½	1	492 DP STS	492 000 STS	6	1½



## POLE STORAGE CLIPS FIG. 477

**Soft Black Plastic**

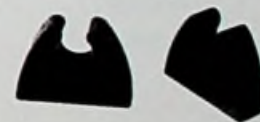

Fig. 477

### ORDERING INFORMATION

For Pole O.D. Inches	Display Pkg.-10 bags 1 Pr. per bag	OEM Pkg.-50 prs.	Screw Size	Weight per Pair Ounces
¾	477 DP BLK	477 000 BLK	8	3



## SPRING CLAMPS FIG. 502

**Stainless Steel**



Fig. 502

### ORDERING INFORMATION

Min. I.D. Inches	Max. I.D. Inches	Projection Inches	Width Clamp Inches	Display Pkg.-10 bags 1 Pr. per bag	Screw Size	Weight per Pair Ounces
5/8	1¼	1½	½	502 DP1 STS	6 R.H.	2
1	1¾	2¼	5/8	502 DP2 STS	6 R.H.	2½



## ROPE PULLEY FIG. 1255



Fig. 1255

**Chrome Plated Zinc  
White Plastic Sheave**

**Coaming Type  
Maximum Rope Size 1/4 Inch.**

### ORDERING INFORMATION

O.D. Sheave Inches	Dimensions Plate Inches	Display Pkg.-10 bags 1 Pc. per bag	Screw Size	Weight Ounces
2 <sup>5</sup> / <sub>16</sub>	4 <sup>7</sup> / <sub>8</sub> x 1 <sup>1</sup> / <sub>4</sub>	1255 DP CHR	6	1/2



## ROPE PULLEY FIG. 565



Fig. 565

**Stainless Steel  
White Plastic Sheave**

**Swivel Type with Strap  
Maximum Rope Size 1/4 Inch.**

### ORDERING INFORMATION

O.D. Sheave Inches	Length Overall Inches	Length Strap Inches	Display Pkg.-5 bags 2 Pcs. per bag	Screw Size	Weight Ounces
2 <sup>5</sup> / <sub>16</sub>	3 <sup>3</sup> / <sub>4</sub>	1 <sup>5</sup> / <sub>8</sub>	565 DP	10 R.H.	2



## ROPE PULLEY FIG. 634



Fig. 634

**Stainless Steel  
White Plastic Sheave**

**Swivel Snap Hook Type  
Maximum Rope Size 1/4 Inch.**

### ORDERING INFORMATION

O.D. Sheave Inches	Length Overall Inches	Opening Snap Throat Inches	Display Pkg.-5 bags 2 Pcs. per bag	Weight Ounces
2 <sup>5</sup> / <sub>16</sub>	4 <sup>5</sup> / <sub>8</sub>	1/2	634 DP	2 <sup>1</sup> / <sub>2</sub>



## ROPE CLAMP FIG. 358

**Plain Cast Bronze**

For 1/8 or 3/16 Inch Rope.



Fig. 358

### ORDERING INFORMATION

Length Overall Inches	Width Inches	Display Pkg.-10 bags 2 Pcs. per bag	OEM Pkg.-100 pcs.	Weight Ounces
1 1/4	1 1/16	358 DP PLB	358 000 PLB	1



## ROPE CLAMP FIG. 1226

**Chrome Plated Zinc**

For 1/8 or 3/16 Inch Rope.



Fig. 1226

### ORDERING INFORMATION

Length Overall Inches	Width Inches	Display Pkg.-25 bags 2 Pcs. per bag	Weight Ounces
1 1/4	1 1/16	1226 DP CHR	1



## ROPE GUIDES FIGS. 1256 & 1261

**Chrome Plated Zinc**

### ORDERING INFORMATION

I.D. Hole Inches	Dimensions Base Inches	Display Pkg.-25 bags 2 Pcs. per bag	OEM Pkg.-100 pcs.	Screw Size	Weight Ounces
5/16	1 1/4 x 3/4	1256 DP CHR	1256 000 CHR	6	1/2
5/16	1 1/4 x 3/4	1261 DP CHR	1261 000 CHR	6	1/2



Fig. 1256



Fig. 1261

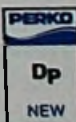



Fig. 1243

## ROPE GUIDE FIG. 1243

**Chrome Plated Zinc  
White Plastic Sheave**

### ORDERING INFORMATION

Maximum Rope Size Inches	O.D. Sheave Inches	Dimensions Base Inches	Display Pkg.-10 bags 1 Pc. per bag	Screw Size	Weight Ounces
1/4	7/8	2 x 3/4	1243 DP CHR	8	1 3/4

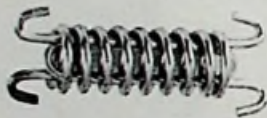

Fig. 732

## ROPE TIGHTENER FIG. 732

**Zinc Plated Spring Steel  
or  
Stainless Steel**

### ORDERING INFORMATION

Finish	Length Normal Inches	Length Compressed Inches	O.D. Inches	Display Pkg.-5 bags 2 Pcs. per bag	Weight Ounces
Zinc	4	5	1	732 DP CAD	3 1/2
Stainless	4	5	1	732 DP STS	2 1/4



Fig. 754

## ROPE TIGHTENER FIG. 754

**Zinc Plated Spring Steel**

### ORDERING INFORMATION

Length Normal Inches	Length Compressed Inches	O.D. Inches	Display Pkg.-10 bags 2 Pcs. per bag	Weight Ounces
4 3/4	6 1/2	7/8	754 DP CAD	2 3/4

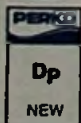



## EYE STRAP FIG. 881

Chrome Plated Forged Bronze



Fig. 881

Length Overall Inches	I.D. Eye Inches	O.D. Stock at Eye Inches	ORDERING INFORMATION				
			Display Pkg.-25 bags 2 Pcs. per bag	OEM Pkg.	OEM Pkg.	Screw Size	Weight Ounces
1 $\frac{7}{8}$	$\frac{1}{4}$	$\frac{1}{4}$	881 DP0 CHR	881 000 CHR	100	8	$\frac{1}{2}$
2 $\frac{1}{4}$	$\frac{5}{16}$	$\frac{9}{32}$	881 DP1 CHR	881 001 CHR	—	10	$\frac{3}{4}$
2 $\frac{3}{4}$	$\frac{1}{2}$	$\frac{5}{16}$	*881 DP2 CHR	881 002 CHR	100	10	1 $\frac{1}{2}$

\*Display Pkg.-10 bags, 2 Pcs. per bag.



## EYE STRAP FIG. 1242

Chrome Plated Zinc



Fig. 1242

Length Overall Inches	I.D. Eye Inches	ORDERING INFORMATION			Screw Size	Weight Ounces
		Display Pkg.-10 bags 5 Pcs. per bag	OEM Pkg.-100 pcs.			
1 $\frac{7}{8}$	$\frac{5}{16}$	1242 DP CHR	1242 000 CHR	8	$\frac{1}{4}$	



## EYE STRAP FIG. 562

300 Series Stainless Steel



Fig. 562

Length Overall Inches	I.D. Eye Inches	ORDERING INFORMATION			Screw Size	Weight Ounces
		Display Pkg.-10 bags 5 Pcs. per bag	OEM Pkg.-100 pcs.			
1 $\frac{5}{8}$	$\frac{1}{4}$	562 DP STS	562 000 STS	10 R.H.	$\frac{1}{8}$	





Fig. 1299

## FENDER LOCK FIG. 1299

Chrome Plated Zinc

The Eye is to be Permanently Attached to the Fender Line.

### ORDERING INFORMATION

I.D. Eye Inches	O.D. Flange Inches	Display Pkg.-10 cds. 2 Pcs. per card	Screw Size	Weight Ounces
3/8	1 1/2	1299 DP CHR	8	1

Spare Eye, Cat. No. 1299 000 99A.



Fig. 1246

## FENDER HOOK FIG. 1246

Chrome Plated Zinc

### ORDERING INFORMATION

Maximum Rope Size Inches	Dimensions Plate Inches	Display Pkg.-10 cds. 2 Pcs. per card	Screw Size	Weight Ounces
3/8	1 3/4 x 1 1/4	1246 DP CHR	6	1 1/4



Fig. 1309

## SNAP TYPE FENDER HOOK FIG. 1309

Chrome Plated Zinc

### ORDERING INFORMATION

Maximum Rope Size Inches	Dimensions Plate Inches	Display Pkg.-10 cds. 2 Pcs. per card	OEM Pkg.-100 pcs.	Screw Size	Weight Ounces
1/4	1 7/16 x 1 3/8	1309 DP CHR	1309 000 CHR	6	1 1/2

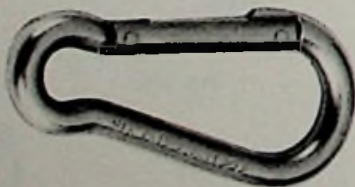

Fig. 614

## FAST EYE SNAP HOOK FIG. 614

Non-Magnetic 316 Series Stainless Steel

Interlocking Tongue

### ORDERING INFORMATION

I.D. Eye Inches	Length Overall Inches	O.D. Stock Inches	Standard Pkg.-10 pcs.	Weight Ounces	Safe Working Load Pounds
3/8	3	5/16	614 000 STS	2 1/2	350



**NOTE: The Snaps Illustrated Below Should Not Be Used For Lifting, Winching, Towing, Mooring or Like Applications.**

## FAST EYE BOAT SNAP FIG. 612

**Plain Bronze**



### ORDERING INFORMATION

I.D. Eye Inches	Length Overall Inches	Standard Pkg.-10 pcs.	Weight Ounces
3/8	2 1/16	612 000 PLB	1
5/8	2 7/8	612 001 PLB	1 1/2
3/4	3	612 002 PLB	2
3/4	3 7/8	612 003 PLB	4

Fig. 612



## SWIVEL EYE BOAT SNAP FIG. 613

**Plain Bronze**



### ORDERING INFORMATION

I.D. Eye Inches	Length Overall Inches	Standard Pkg.-10 pcs.	Weight Ounces
9/16	3 1/4	613 001 PLB	2
1 1/16	3 5/8	613 002 PLB	3
3/4	4 5/8	613 003 PLB	4

Fig. 613



## SWIVEL EYE SNAP FIG. 659

**Plain Bronze**

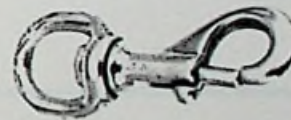

### ORDERING INFORMATION

I.D. Eye Inches	I.D. Hook Inches	Length Overall Inches	Display Pkg.-10 cds. 1 Pc. per card	Weight Ounces
3/4	7/16	3 1/2	659 DP PLB	2 1/2

Fig. 659



## SWIVEL EYE SNAP FIG. 1289

**Chrome Plated Zinc**

**Interlocking Tongue**



### ORDERING INFORMATION

I.D. Eye Inches	Length Overall Inches	Display Pkg.-10 cds. 1 Pc. per card	Weight Ounces
5/8	3	1289 DP CHR	2 1/2

Fig. 1289



**NOTE: The Snaps Illustrated Below Should Not Be Used For Lifting, Winching, Towing, Mooring or Like Applications.**

## SWIVEL EYE BABY SNAP FIG. 1041

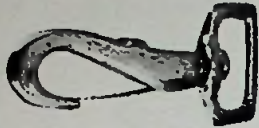

Fig. 1041



**Plain Bronze**

### ORDERING INFORMATION

Dimensions Eye Inches	Length Overall Inches	Standard Pkg.-50 pcs.	Weight Ounces
5/8 x 5/16	1 3/4	1041 000 PLB	1/2

## SWIVEL EYE BABY SNAP FIG. 1042



Fig. 1042



**Plain Bronze**

### ORDERING INFORMATION

I.D. Eye Inches	Length Overall Inches	Standard Pkg.-50 pcs.	Weight Ounces
3/8	2 1/8	1042 000 PLB	1/2

## FAST EYE BABY SNAP FIG. 842



Fig. 842



**Plain Bronze**

### ORDERING INFORMATION

I.D. Eye Inches	Length Overall Inches	Standard Pkg.-50 pcs.	Weight Ounces
3/8	1 7/8	842 000 PLB	1/2

## HAND WINDSHIELD WIPER FIG. 533

**Chrome Plated Zinc  
400 Series Stainless Steel Arm and Blade Holder**

For Straight and Curved Windshields,  
the Arm is Extendable from 6 3/4 to 10 1/2 Inches  
(Length Overall is 8 to 11 1/2 Inches), and the Spring Tension is Adjustable.

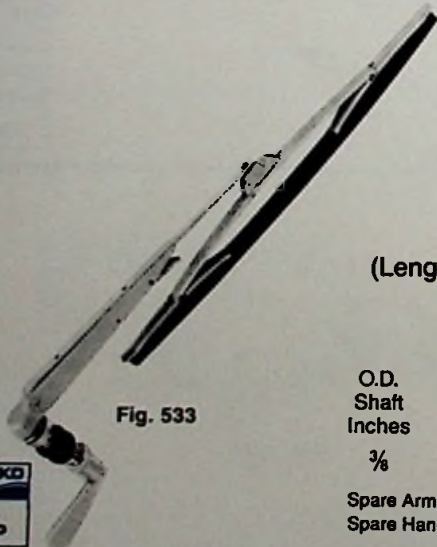

Fig. 533

### ORDERING INFORMATION

O.D. Shaft Inches	Maximum Thickness of Panel Inches	Length Handle Inches	Length Blade Inches	Display Pkg.-5 cds. 1 Pc. per card	Std. Pkg.-5 pcs. OEM Pkg.-25 pcs.	Weight Ounces
3/8	1 1/8	2 3/8	12	533 DP STS	533 000 STS	8

Spare Arm, Cat. No. 533 000 99A.  
Spare Handle, Cat. No. 533 000 99D.

Spare Curved Blade, Cat. No. 533 000 99B.



## NORTH RIVER TYPE ROWLOCK HORNS FIG. 1227

**Zinc  
Plain or Chrome Plated**



Fig. 1227

Finish	O.D. Shank Inches	Length Shank Inches	Between Horns Inches	ORDERING INFORMATION		Weight per Pair Ounces
				Display Pkg.-10 cds. 1 Pr. per card	Standard Pkg.-10 prs.	
Plain	1/2	1 3/4	1 3/4	1227 DP ZNC	1227 000 ZNC	10
Chrome	1/2	1 3/4	1 3/4	1227 DP CHR	1227 000 CHR	10



## ROUND TYPE ROWLOCK HORNS FIG. 1267

**Zinc  
Plain or Chrome Plated**



Fig. 1267

Finish	O.D. Shank Inches	Length Shank Inches	I.D. Horn Inches	ORDERING INFORMATION		Weight per Pair Ounces
				Display Pkg.-10 cds. 1 Pr. per card	Standard Pkg.-10 prs.	
Plain	1/2	1 3/4	2	1267 DP ZNC	1267 000 ZNC	9 1/2
Chrome	1/2	1 3/4	2	1267 DP CHR	1267 000 CHR	9 1/2



## RIBBED TYPE ROWLOCK HORNS FIG. 1262

**Zinc  
Plain or Chrome Plated**



Fig. 1262

Finish	O.D. Shank Inches	Length Shank Inches	Between Horns Inches	ORDERING INFORMATION		Weight per Pair Ounces
				Display Pkg.-10 cds. 1 Pr. per card	Standard Pkg.-10 prs.	
Plain	1/2	1 3/4	1 3/4	1262 DP ZNC	1262 000 ZNC	8
Chrome	1/2	1 3/4	1 3/4	1262 DP CHR	1262 000 CHR	8



## TOP MOUNT ROWLOCK SOCKETS FIG. 1185



Fig. 1185

**Zinc**  
**Plain or Chrome Plated**  
**Black Plastic Bearings**

**ORDERING INFORMATION**

Finish	Length Inches	Width Inches	Depth Inches	Display Pkg.-10 cds. 1 Pr. per card	Std. Pkg.-10 prs. OEM Pkg.-50 prs.	Weight per Pair Ounces
Plain	2 <sup>7</sup> / <sub>8</sub>	1 <sup>1</sup> / <sub>8</sub>	1 <sup>1</sup> / <sub>8</sub>	1185 DP ZNC	1185 000 ZNC	5
Chrome	2 <sup>7</sup> / <sub>8</sub>	1 <sup>1</sup> / <sub>8</sub>	1 <sup>1</sup> / <sub>8</sub>	1185 DP CHR	1185 000 CHR	5

Screw Size #10.

Spare Plastic Bearing, Cat. No. 1155 000 BLK.



## SIDE MOUNT ROWLOCK SOCKETS FIG. 1186

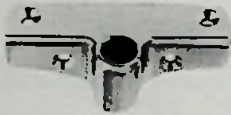

Fig. 1186

**Zinc**  
**Plain or Chrome Plated**  
**Black Plastic Bearings**

**ORDERING INFORMATION**

Finish	Length Inches	Width Inches	Depth Inches	Display Pkg.-10 cds. 1 Pr. per card	Standard Pkg.-10 prs.	OEM Pkg. Prs.	Weight per Pair Ounces
Plain	4	7 <sup>7</sup> / <sub>8</sub>	1 <sup>1</sup> / <sub>8</sub>	1186 DP ZNC	1186 000 ZNC	50	9
Chrome	4	7 <sup>7</sup> / <sub>8</sub>	1 <sup>1</sup> / <sub>8</sub>	1186 DP CHR	1186 000 CHR	—	9

Screw Size #10.

Spare Plastic Bearing, Cat. No. 1155 000 BLK.



## SIDE MOUNT ROWLOCK SOCKETS FIG. 1187



Fig. 1187

**Zinc**  
**Plain or Chrome Plated**  
**Black Plastic Bearings**

**ORDERING INFORMATION**

Finish	Length Inches	Depth Inches	Display Pkg.-10 cds. 1 Pr. per card	Standard Pkg.-10 prs.	OEM Pkg. Prs.	Weight per Pair Ounces
Plain	4	1 <sup>1</sup> / <sub>4</sub>	1187 DP ZNC	1187 000 ZNC	50	6
Chrome	4	1 <sup>1</sup> / <sub>4</sub>	1187 DP CHR	1187 000 CHR	—	6

Screw Size #10.

Spare Plastic Bearing, Cat. No. 1155 000 BLK.



## OAR LEATHERS & BUTTONS FIG. 233



Fig. 233

**Leather**

**ORDERING INFORMATION**

Dimensions Leather Inches	Dimensions Button Inches	Standard Pkg.-5 prs.	Weight per Pair Ounces
7 x 6 <sup>1</sup> / <sub>2</sub>	1 <sup>1</sup> / <sub>2</sub> x 13	233 001	10

Note: Pair consists of 2 Leathers and 2 Buttons.



## NORTH RIVER TYPE ROWLOCK HORNS FIG. 830

Plain Manganese Bronze

### ORDERING INFORMATION

O.D. Shank Inches	Length Shank Inches	Between Horns Inches	Display Pkg.-5 cds. 1 Pr. per card	Standard Pkg.-5 prs.	Weight per Pair Ounces
1/2	2 1/8	2 1/8	830 DP PLB	830 000 PLB	13



Fig. 830



## ROUND TYPE ROWLOCK HORNS FIG. 829

Plain Manganese Bronze

### ORDERING INFORMATION

O.D. Shank Inches	Length Shank Inches	I.D. Horns Inches	Display Pkg.-5 cds. 1 Pr. per card	Standard Pkg.-5 prs.	Weight per Pair Ounces
1/2	2 1/8	2	829 DP0 PLB	829 000 PLB	14
1/2	2 1/8	2 1/4	829 DP1 PLB	829 001 PLB	16



Fig. 829

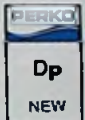

## RIBBED TYPE ROWLOCK HORNS FIG. 828

Plain Manganese Bronze

### ORDERING INFORMATION

O.D. Shank Inches	Length Shank Inches	Between Horns Inches	Display Pkg.-5 cds. 1 Pr. per card	Standard Pkg.-5 prs.	Weight per Pair Ounces
1/2	2 1/8	2	828 DP PLB	828 000 PLB	13



Fig. 828



## ROWLOCK SOCKETS FIGS. 831, 832 & 833

Plain Manganese Bronze

### ORDERING INFORMATION

Length Inches	Width Inches	Depth Inches	Display Pkg.-5 cds. 1 Pr. per card	Standard Pkg.-5 prs.	Weight per Pair Ounces
2 3/8	7/8	1	831 DP PLB	831 000 PLB	4
3 5/8	—	1 1/8	832 DP PLB	832 000 PLB	7
4	3/4	1 1/4	833 DP PLB	833 000 PLB	8

Screw Size #10.



Fig. 833



Fig. 831



Fig. 832





## TABLE BRACKETS FIG. 148

**Chrome Plated Brass**

For Removable Tables

Supplied in Sets Consisting of Two Brackets and Two Wall Plates.



Fig. 148

Dimensions		Dimensions		ORDERING INFORMATION			Weight
Angle Bracket	Wall Plate	Display Pkg.-5 cds.	Std. Pkg.-5 sets	Screw	per Set		
Inches	Inches	1 Set per card	OEM Pkg.-25 sets	Size	Ounces		
2 3/4 x 1 1/16	3 3/8 x 2	148 DP CHR	148 000 CHR	10	12		
Spare Brackets, Cat. No. 148 000 99A.				Spare Wall Plates, Cat. No. 148 000 99B.			

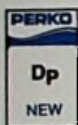

## LADDER LOCKS FIG. 669

**Chrome Plated Bronze**



Fig. 669

Height		Length		ORDERING INFORMATION		Weight
Overall	Socket	Bracket	Std. Pkg.-5 sets	Screw	per Set	
Inches	Inches	Inches	OEM Pkg.-25 sets	Size	Ounces	
1 1/4	1	1 3/4	669 000 CHR	8	12	
Spare Pair of Sockets, Cat. No. 669 000 99A.						



Fig. 411

## SAIL MAKER'S PALM FIG. 411

**Leather  
Right Hand**

ORDERING INFORMATION		Weight
Standard	Pkg.-10 pcs.	Ounces
411		2





## WINDSHIELD ADJUSTERS FIGS. 1290 & 1291

Chrome Plated Zinc  
Black Plastic Knob

Fig. 1290 — Side Mount  
Fig. 1291 — Offset Mount

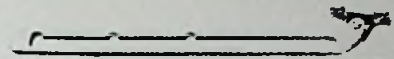

Side  
Mount  
Fig. 1290

Offset  
Mount  
Fig. 1291

### ORDERING INFORMATION

Length Overall Inches	Length Adjustment Inches	Fig. 1290 Std. Pkg.-1 pr. OEM Pkg.-10 prs.	Fig. 1291 Std. Pkg.-1 pr. OEM Pkg.-10 prs.	Screw Size	Weight per Pair Pounds
12	9½	1290 000 CHR	1291 000 CHR	8	1½

### SPARE PARTS ORDERING INFORMATION

Figure No	Port Adjuster	Starboard Adjuster	Mounting Bracket W/Knob	Knob Only
1290	1290 P00 99A	1290 S00 99A	1290 000 99B	1292 000 BLK
1291	1291 P00 99A	1291 S00 99A	1291 000 99B	1292 000 BLK

NOTE: Illustration is Port Side.

## WINDSHIELD ADJUSTER FIG. 82

Chrome Plated Brass and Bronze  
Black Plastic Knob

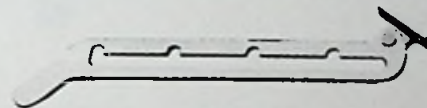

Fig. 82

### ORDERING INFORMATION

Length Overall Inches	Length Adjustment Inches	Standard Pkg.-1 pr.	Screw Size	Weight per Pair Pounds
12	9½	82 000 CHR	8	2¾

Spare Port Adjuster, Cat. No. 82 P00 99B.  
Spare Starboard Adjuster, Cat. No. 82 S00 99B.  
Spare Black Knob, Cat. No. 82 000 99A.

NOTE: Illustration is Starboard Side.

## WINDSHIELD ADJUSTER FIG. 360

Chrome Plated Brass and Zinc  
Black Plastic Knob

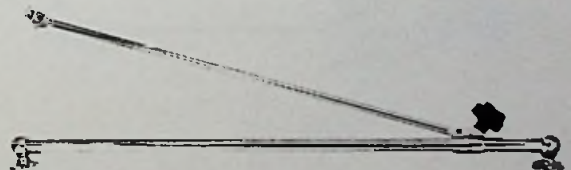

Fig. 360

### ORDERING INFORMATION

Length Base Overall Inches	Length Windshield Arm Inches	Length Adjustment Inches	Standard Pkg.-1 pc.	Bracket Screw Size	Deck Socket Screw Size	Weight Pounds
27½	23	22½	360 000 CHR	8	6	3¾

Spare Knob, Cat. No. 360 000 99A.  
Spare Slide Body & Pad, Cat. No. 360 000 99B.

## WINDSHIELD ADJUSTER FIG. 1179

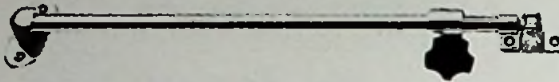

Fig. 1179

Chrome Plated Brass and Zinc  
Black Plastic Knob

### ORDERING INFORMATION

Length Closed Inches	Length Open Inches	O.D. Tube Inches	Display Pkg.-5 cds. 1 Pc. per card	Std. Pkg.-5 pcs. OEM Pkg.-20 pcs.	Screw Size	Weight Ounces
10	18	1/2	1179 DP1 CHR	1179 001 CHR	6	9
12	20	1/2	1179 DP2 CHR	1179 002 CHR	6	11

Spare Knob, Cat. No. 1117 DP BLK.



## WINDSHIELD ADJUSTER FIG. 1180

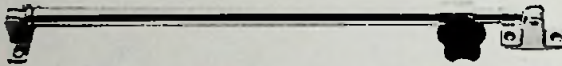

Fig. 1180

Chrome Plated Brass and Zinc  
Black Plastic Knob

### ORDERING INFORMATION

Length Closed Inches	Length Open Inches	O.D. Tube Inches	Display Pkg.-5 cds. 1 Pc. per card	Std. Pkg.-5 pcs. OEM Pkg.-20 pcs.	Screw Size	Weight Ounces
12	21	1/2	1180 DP CHR	1180 000 CHR	6	10

Spare Knob, Cat. No. 1117 DP BLK.



## WINDSHIELD ADJUSTER FIG. 1116

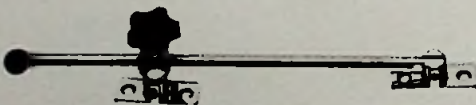

Fig. 1116

Chrome Plated Brass and Zinc  
Black Plastic Knob

### ORDERING INFORMATION

Length Rod Inches	O.D. Rod Inches	Display Pkg.-5 cds. 1 Pc. per card	Standard Pkg.-5 pcs.	OEM Pkg.	Screw Size	Weight Ounces
8	3/8	1116 DP1 CHR	1116 001 CHR	20	8	8
10	3/8	1116 DP2 CHR	1116 002 CHR	—	8	10
12	3/8	1116 DP3 CHR	1116 003 CHR	20	8	12

Spare Knob, Cat. No. 1117 DP BLK.

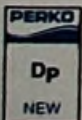

## HATCH ADJUSTER FIG. 797

**Chrome Plated Brass and Zinc  
Black Plastic Knob**

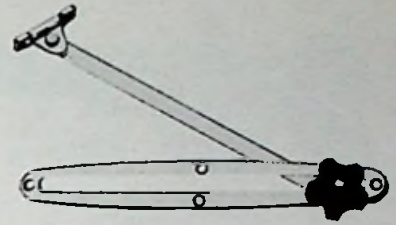
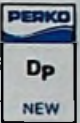

Fig. 797

ORDERING INFORMATION						
Length Arm Inches	Length Adjustment Inches	Length Slide Inches	Display Pkg.-5 cds. 1 Pc. per card	Std. Pkg.-5 pcs. OEM Pkg.-20 pcs.	Screw Size	Weight Ounces
10	9½	10¾	797 DP CHR	797 000 CHR	8	13



## HATCH SUPPORT BRACES FIG. 762

**Chrome Plated Brass**

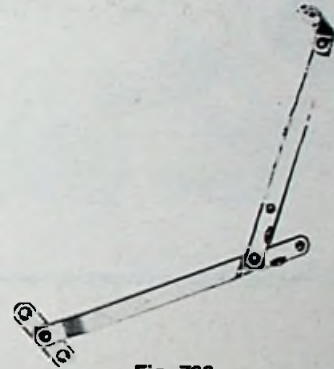

Fig. 762

ORDERING INFORMATION					
Length Open Inches	Display Pkg.-5 cds. 1 Pair per card	Standard Pkg.-5 prs.	OEM Pkg. Prs.	Screw Size	Weight per Pair Ounces
10	762 DP1 CHR	762 001 CHR	20	8	10
12	762 DP2 CHR	762 002 CHR	20	8	12
14	762 DP3 CHR	762 003 CHR	20	8	14

NOTE: Illustration is Port Side.



## HATCH FASTENER OR WINDSHIELD KEEPER FIG. 155

**Chrome Plated Brass and Zinc  
Phosphor Bronze Spring**



Fig. 155

ORDERING INFORMATION					
Length Overall Inches	Dimensions Mounting Base Inches	Display Pkg.-5 bags 1 Pc. per bag	Std. Pkg.-5 pcs. OEM Pkg.-50 pcs.	Screw Size	Weight Ounces
3¾	1½ x ¾	155 DP CHR	155 000 CHR	6	3¼



## HATCH FASTENER OR WINDSHIELD KEEPER FIG. 769



Fig. 769

**Chrome Plated Brass and Zinc  
Black Plastic Handle**

### ORDERING INFORMATION

Dimensions Base Inches	Display Pkg.-5 cds. 1 Pc. per card	Std. Pkg.-5 pcs. OEM Pkg.-25 pcs.	Screw Size	Weight Ounces
1 1/2 x 5/8	769 DP CHR	769 000 CHR	8	6

Spare Keeper, Cat. No. 769 000 99A.  
Spare Handle with Stud, Cat. No. 769 000 99C.



## HATCH FASTENER OR WINDSHIELD KEEPER FIG. 697

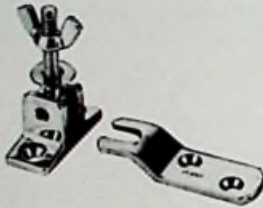

Fig. 697

**Chrome Plated Brass and Zinc**

### ORDERING INFORMATION

Length Bolt Inches	Dimensions Bracket Inches	Dimensions Keeper Inches	Display Pkg.-10 bags 1 Pc. per bag	Standard Pkg.-10 pcs.	Weight Ounces
1 1/2	1 1/2 x 5/8	1 1/2 x 3/4	697 DP CHR	697 000 CHR	3



## HATCH FASTENER OR WINDSHIELD KEEPER FIG. 967



Fig. 967

**Chrome Plated Bronze**

### ORDERING INFORMATION

Length Bolt Inches	Dimensions Bracket Inches	Dimensions Keeper Inches	Display Pkg.-5 cds. 1 Pc. per card	Standard Pkg.-5 pcs.	Screw Size	Weight Ounces
1 1/2	1 1/16 x 1	1 7/8 x 7/8	967 DP CHR	967 000 CHR	8	6



## HATCH FASTENER FIG. 770



Fig. 770

**Chrome Plated Bronze  
Black Plastic Knob**

### ORDERING INFORMATION

Dimensions Overall Inches	Adjustment Thread Inches	Display Pkg.-5 cds. 1 Pc. per card	Std. Pkg.-5 pcs. OEM Pkg.-25 pcs.	Screw Size	Weight Ounces
3 3/4 x 1 5/8	2 1/4	770 DP CHR	770 000 CHR	8	6



## HOLD-DOWN CLAMP FIG. 1112

Chrome Plated Bronze

Flat Mounting



Fig. 1112

### ORDERING INFORMATION

Length Inches	Width Inches	Display Pkg.-5 cds. 1 Pc. per card	Std. Pkg.-5 pcs. OEM Pkg.-25 pcs.	Screw Size	Weight Ounces
3	1½	1112 DP CHR	1112 000 CHR	8	5½



## HOLD-DOWN CLAMP FIG. 1113

Chrome Plated Bronze

Angle Mounting



Fig. 1113

### ORDERING INFORMATION

Length Inches	Width Inches	Display Pkg.-5 cds. 1 Pc. per card	Std. Pkg.-5 pcs. OEM Pkg.-25 pcs.	Screw Size	Weight Ounces
2½	1½	1113 DP CHR	1113 000 CHR	8	5½



## LOCKABLE HOLD-DOWN CLAMP FIG. 1108

Chrome Plated Bronze

### ORDERING INFORMATION

Dimensions Base Inches	Clearance Padlock Inches	Display Pkg.-5 cds. 1 Pc. per card	Std. Pkg.-5 pcs. OEM Pkg.-25 pcs.	Screw Size	Weight Ounces
2¾ x 1¾	¼	1108 DP CHR	1108 000 CHR	6	4



Fig. 1108



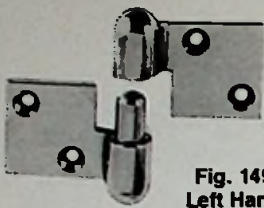

Fig. 149  
Left Hand

## PULL APART HINGES FIGS. 149 & 152

Chrome Plated Bronze

Fig. 149 — Left Hand

Fig. 152 — Right Hand

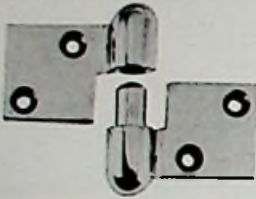

Fig. 152  
Right Hand

Use 2 Left Hand or 2 Right Hand For Quick Removal of Hatches, Motor Covers, etc. or Together (1 each Left & Right) as a Heavy Duty Hinge.

### ORDERING INFORMATION

Length Open Inches	Width Overall Inches	Display Pkg.-5 cds. 1 Pc. per card	Std. Pkg.-5 pcs. OEM Pkg.-25 pcs.	Screw Size	Weight Ounces
3¾	2	149 DP CHR	149 000 CHR	10	5½
3¾	2	152 DP CHR	152 000 CHR	10	5½



## HATCH TRIM FIG. 258

Polished Stainless Steel

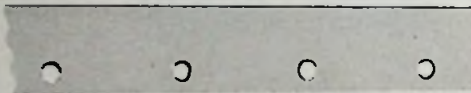
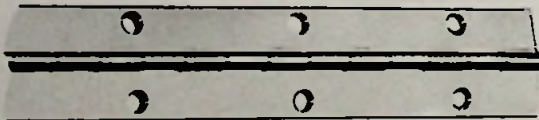

Fig. 258 — Polished Stainless Steel

### ORDERING INFORMATION

Width Inches	Length Overall Inches	Standard Pkg.-10 pcs.	Screw Size	Weight Pounds
1¼	72	258 002 STS	6	1
1½	72	258 004 STS	6	1½



## CONTINUOUS HINGE FIG. 212

Polished Stainless Steel

Countersunk holes are two inches apart, center to center.

Fig. 212 — Polished Stainless Steel

### ORDERING INFORMATION

Width Open Inches	Length Overall Inches	Standard Pkg.-10 pcs.	Screw Size	Weight Pounds
1¼	72	212 002 STS	5	1½
1½	72	212 004 STS	5	2



## BUTT HINGE FIG. 1002

**Heavy Gauge Extruded Brass  
Plain or Chrome Plated  
Fast Pin**

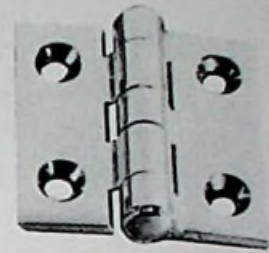

Fig. 1002

ORDERING INFORMATION							
Height Pin Inches	Width Open Inches	Plain Brass Catalog No.	Chrome Plated Brass Catalog No.	Std. Pkg. Prs.	Screw Size	No. of Holes	Weight per Pair Pounds
1½	1½	1002 002 PLB	1002 002 CHR	5	6	4	¼
2	1½	1002 003 PLB	1002 003 CHR	5	6	4	¼
2	2	1002 004 PLB	1002 004 CHR	5	6	6	¾
2½	2	1002 005 PLB	1002 005 CHR	1	8	6	½
2½	2½	1002 006 PLB	1002 006 CHR	1	8	6	⅝
3	2	1002 007 PLB	1002 007 CHR	1	8	6	⅝
3	2½	1002 008 PLB	1002 008 CHR	1	8	6	¾
3	3	1002 009 PLB	1002 009 CHR	1	10	6	1¼
3½	2½	1002 010 PLB	1002 010 CHR	1	10	6	⅞
3½	3	1002 011 PLB	1002 011 CHR	1	10	6	1¼
4	3	1002 012 PLB	1002 012 CHR	1	10	6	1½
4	4	1002 013 PLB	1002 013 CHR	1	¼	6	1¾
5	4	1002 014 PLB	1002 014 CHR	1	¼	8	2¼



## BUTT HINGE FIG. 1003

**Heavy Gauge Extruded Brass  
Plain or Chrome Plated  
Removable Pin**

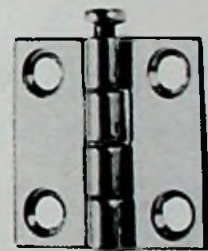
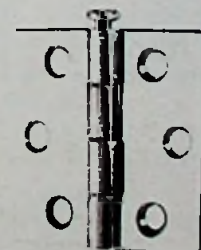

Fig. 1003

ORDERING INFORMATION							
Height Pin Inches	Width Open Inches	Plain Brass Catalog No.	Chrome Plated Brass Catalog No.	Std. Pkg. Prs.	Screw Size	No. of Holes	Weight per Pair Pounds
1½	1½	1003 002 PLB	1003 002 CHR	5	6	4	¼
2	1½	1003 003 PLB	1003 003 CHR	5	6	4	¼
2	2	1003 004 PLB	1003 004 CHR	5	6	6	¾
2½	2	1003 005 PLB	1003 005 CHR	1	8	6	½
2½	2½	1003 006 PLB	1003 006 CHR	1	8	6	⅝
3	2	1003 007 PLB	1003 007 CHR	1	8	6	⅝
3	2½	1003 008 PLB	1003 008 CHR	1	8	6	¾
3	3	1003 009 PLB	1003 009 CHR	1	10	6	1¼
3½	2½	1003 010 PLB	1003 010 CHR	1	10	6	⅞
3½	3	1003 011 PLB	1003 011 CHR	1	10	6	1¼
4	3	1003 012 PLB	1003 012 CHR	1	10	6	1½
4	4	1003 013 PLB	1003 013 CHR	1	¼	6	1¾
5	4	1003 014 PLB	1003 014 CHR	1	¼	8	2¼



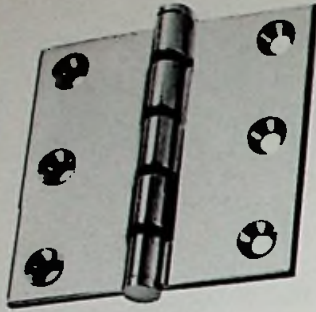

Fig. 1004

## BUTT HINGE FIG. 1004

**Chrome Plated Extruded Brass  
Extra Heavy Duty, Plastic Bearings  
Removable Pin**

For Transom Doors and Other Applications Where Extra Strength is Required.

### ORDERING INFORMATION

Height Pin Inches	Width Open Inches	Standard Pkg.-1 pr.	Screw Size	No. of Holes	Weight per Pair Pounds
4	4	1004 000 CHR	¼	6	1½

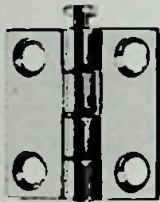

Fig. 1293

## BUTT HINGE FIG. 1293

**Chrome Plated Zinc  
Removable Pin**

### ORDERING INFORMATION

Height Pin Inches	Width Open Inches	Display Pkg.-5 bags 1 Pr. per bag	Standard Pkg.-5 prs.	OEM Pkg. Prs.	Screw Size	No. of Holes	Weight per Pair Ounces
1½	1½	1293 DP2 CHR	1293 002 CHR	—	8	4	2
2	1½	1293 DP3 CHR	1293 003 CHR	—	8	4	2½
2	2	1293 DP4 CHR	1293 004 CHR	50	8	4	3
2½	2	1293 DP5 CHR	1293 005 CHR	25	8	6	4½
2½	2½	1293 DP6 CHR	1293 006 CHR	25	8	6	5
3	3	1293 DP9 CHR	1293 009 CHR	25	10	6	7½

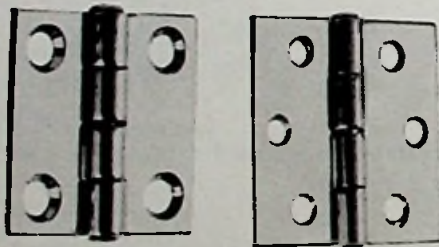

Fig. 949

## BUTT HINGE FIG. 949

**Heavy Gauge Stamped Brass  
Plain or Chrome Plated  
Fast Pin**

### ORDERING INFORMATION

Height Pin Inches	Width Open Inches	Chrome Plated Brass		Std. Pkg. Prs.	Screw Size	No. of Holes	Weight per Pair Ounces	
		Display Pkg.-5 bags 1 Pr. per bag	Plain Brass Standard Pkg.					
1½	1¼	949 DP1 CHR	949 001 PLB	*949 001 CHR	5	6	4	2
1½	1½	949 DP2 CHR	949 002 PLB	*949 002 CHR	5	6	4	2½
2	1½	949 DP3 CHR	949 003 PLB	*949 003 CHR	5	6	4	2¾
2	2	949 DP4 CHR	949 004 PLB	949 004 CHR	5	6	6	4
2½	2	949 DP5 CHR	949 005 PLB	949 005 CHR	1	8	6	5
2½	2½	949 DP6 CHR	949 006 PLB	949 006 CHR	1	8	6	6¾
3	3	949 DP9 CHR	949 009 PLB	949 009 CHR	1	10	6	9½



\*No O.E.M. Pkg. Available.



## BUTT HINGE FIG. 952

Heavy Gauge Stamped Brass  
Plain or Chrome Plated  
Removable Pin

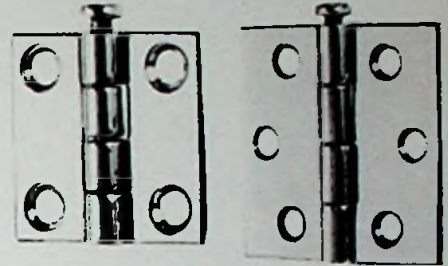

Fig. 952

### ORDERING INFORMATION

Height Pin Inches	Width Open Inches	Chrome Plated Brass		Chrome Plated Brass Standard Pkg.	Std. Pkg. Prs.	Screw Size	No. of Holes	Weight per Pair Ounces
		Display Pkg.-5 bags 1 Pr. per bag	Plain Brass Standard Pkg.					
1½	1¼	952 DP1 CHR	952 001 PLB	952 001 CHR	5	6	4	2
1½	1½	952 DP2 CHR	952 002 PLB	952 002 CHR	5	6	4	2½
2	1½	952 DP3 CHR	952 003 PLB	952 003 CHR	5	6	4	2¾
2	2	952 DP4 CHR	952 004 PLB	*952 004 CHR	5	6	6	4
2½	2	952 DP5 CHR	952 005 PLB	*952 005 CHR	1	8	6	5
2½	2½	952 DP6 CHR	*952 006 PLB	952 006 CHR	1	8	6	6¾
3	3	952 DP9 CHR	*952 009 PLB	*952 009 CHR	1	10	6	9½

\*O.E.M. Pkg.-25 prs.



## HINGE FIG. 773

Chrome Plated Bronze  
Removable Pin



Fig. 773

### ORDERING INFORMATION

Length Overall Inches	Width Overall Inches	Standard Pkg.-1 pr.	Screw Size	Weight per Pair Ounces
3½	2¾	773 000 CHR	10	1½

## HINGE FIG. 951

Chrome Plated Bronze



Fig. 951

### ORDERING INFORMATION

Length Open Inches	Width Overall Inches	Display Pkg.-5 cds. 1 Pr. per card	Std. Pkg.-5 prs. OEM Pkg.-25 prs.	Screw Size	Weight per Pair Ounces
3	1½	951 DP1 CHR	951 001 CHR	8	3½
4	1½	951 DP2 CHR	951 002 CHR	8	5½



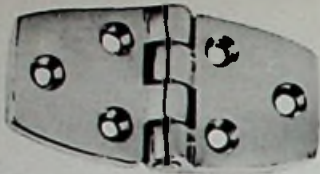

Fig. 808

## HINGE FIG. 808

Chrome Plated Zinc



Length Open Inches	Width Overall Inches	ORDERING INFORMATION			Screw Size	Weight per Pair Ounces
		Display Pkg.-10 cds. 1 Pr. per card	Std. Pkg.-10 prs. OEM Pkg.-50 prs.			
3	1½	808 DP CHR	808 000 CHR	8	3½	



## SHORTSIDE HINGES FIGS. 987 & 1213

Fig. 987 — Chrome Plated Bronze  
Fig. 1213 — Chrome Plated Zinc

Fig. 987 — Chrome Plated Bronze  
Fig. 1213 — Chrome Plated Zinc



Length Open Inches	Width Overall Inches	Length Shortside Inches	ORDERING INFORMATION		Screw Size	Weight per Pair Ounces
			Display Pkg.-5 bags 1 Pr. per bag	Std. Pkg.-5 prs. OEM Pkg.-50 prs.		
2¼	1½	¾	987 DP1 CHR	987 001 CHR	8	3½
2¾	1½	¾	987 DP2 CHR	*987 002 CHR	8	4
2½	1½	¾	1213 DP1 CHR	1213 001 CHR	8	3

\*No OEM Package Available.

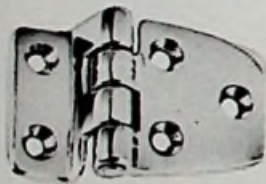

## OFFSET SHORTSIDE HINGES FIGS. 988 & 1214

Fig. 988 — Chrome Plated Bronze  
Fig. 1214 — Chrome Plated Zinc

Fig. 988 — Chrome Plated Bronze  
Fig. 1214 — Chrome Plated Zinc



Length Open Inches	Width Overall Inches	Length Shortside Inches	Offset Inches	ORDERING INFORMATION		Screw Size	Weight per Pair Ounces
				Display Pkg.-5 bags 1 Pr. per bag	Std. Pkg.-5 prs. OEM Pkg.-50 prs.		
2¼	1½	¾	¾	—————	988 001 CHR	8	4
2¾	1½	¾	¾	—————	*988 002 CHR	8	5
2¼	1½	¾	¾	1214 DP1 CHR	1214 001 CHR	8	4

\*No O.E.M. Pkg. Available.



Fig. 999

## SHORTSIDE HINGE FIG. 999

Chrome Plated Bronze

### ORDERING INFORMATION

Length Open Inches	Width Overall Inches	Length Shortside Inches	Std. Pkg.-5 prs. OEM Pkg.-25 prs.	Screw Size	Weight per Pair Ounces
3½	1½	1½	999 000 CHR	8	5

## OFFSET HINGE FIG. 942

**Chrome Plated Zinc**

### ORDERING INFORMATION

Length Open Inches	Width Overall Inches	Offset Inches	Std. Pkg.-5 prs. OEM Pkg.-50 prs.	Screw Size	Weight per Pair Ounces
1½	1½	¾	942 000 CHR	8	2½



Fig. 942

## BUTT HINGE FIG. 941

**Chrome Plated Zinc**

### ORDERING INFORMATION

Length Open Inches	Width Overall Inches	Std. Pkg.-5 prs. OEM Pkg.-50 prs.	Screw Size	Weight per Pair Ounces
1½	1½	941 000 CHR	8	2½

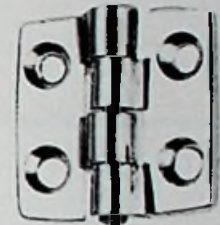

Fig. 941

## INSET HINGE FIG. 271

**Semi-Concealed  
For Inset Doors**

**Stamped Brass  
Plain or Chrome Plated**

**¾ Inch Inset**

### ORDERING INFORMATION

Dimensions Inches	Chrome Plated Brass Display Pkg.-10 bags 1 Pr. per bag	Plain Brass Std. Pkg.-10 prs. OEM Pkg.-100 prs.	Chrome Plated Brass Std. Pkg.-10 prs. OEM Pkg.-100 prs.	Screw Size	Weight per Pair Ounces
2¾ x 2½	271 DP CHR	271 000 PLB	271 000 CHR	4	2½

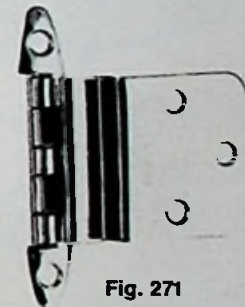

Fig. 271



## FLUSH HINGE FIG. 272

**Semi-Concealed  
For Overlay Doors**

**Stamped Brass  
Plain or Chrome Plated**

### ORDERING INFORMATION

Dimensions Inches	Chrome Plated Brass Display Pkg.-10 bags 1 Pr. per bag	Plain Brass Std. Pkg.-10 prs. OEM Pkg.-100 prs.	Chrome Plated Brass Std. Pkg.-10 prs. OEM Pkg.-100 prs.	Screw Size	Weight per Pair Ounces
2¾ x 2½	272 DP CHR	272 000 PLB	272 000 CHR	4	2½

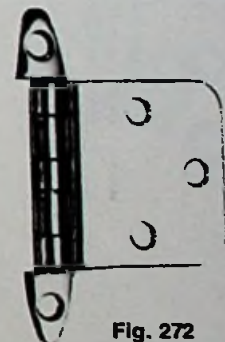

Fig. 272





Fig. 120

## STRAP HINGE FIG. 120

Chrome Plated Bronze

### ORDERING INFORMATION

Length Open Inches	Width Pin Inches	Display Pkg.-5 cds. 1 Pr. per card	Std. Pkg.-5 prs. OEM Pkg.-25 prs.	Screw Size	No. of Holes	Weight per Pair Ounces
4	1 $\frac{1}{8}$	120 DP1 CHR	120 001 CHR	10	4	6
6	1 $\frac{1}{8}$	120 DP2 CHR	120 002 CHR	10	6	8
8	1 $\frac{3}{8}$	120 DP3 CHR	*120 003 CHR	12	6	16

\*No O.E.M. Pkg. Available.



Fig. 122

## SHORTSIDE STRAP HINGE FIG. 122

Chrome Plated Bronze

### ORDERING INFORMATION

Length Open Inches	Width Pin Inches	Shortside Length Inches	Standard Pkg.-5 prs.	Screw Size	No. of Holes	Weight per Pair Ounces
4 $\frac{7}{8}$	1 $\frac{1}{8}$	2 $\frac{1}{8}$	122 000 CHR	10	5	7

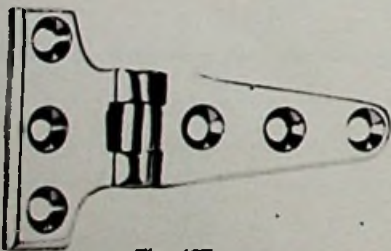

Fig. 197

## "T" HINGE FIG. 197

Chrome Plated Bronze

### ORDERING INFORMATION

Length Open Inches	Width Overall Inches	Length "T" Side Inches	Standard Pkg.	Std. Pkg. Prs.	OEM Pkg. Prs.	Screw Size	No. of Holes	Weight per Pair Ounces
4	2 $\frac{1}{8}$	1 $\frac{5}{16}$	197 001 CHR	5	10	10	6	8
6	3	1 $\frac{1}{2}$	197 002 CHR	1	—	10	7	16
8	3 $\frac{3}{8}$	2	197 003 CHR	1	—	12	8	25

## HINGE FIG. 924

**Chrome Plated Stamped Brass**



Fig. 924

Length Open Inches	Width Overall Inches	ORDERING INFORMATION			Screw Size	Weight per Pair Ounces
		Display Pkg.-10 cds. 1 Pr. per card	Std. Pkg.-10 prs. OEM Pkg.-50 prs.			
3	1½	924 DP CHR	924 000 CHR	6	2½	



## NON-MORTISED HINGE FIG. 957

**Stamped Brass  
Plain or Chrome Plated**

Easily Installs Without Mortising.

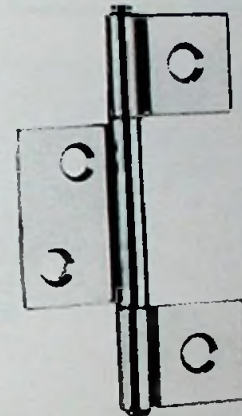

Fig. 957

Height Pin Inches	Width Closed Inches	ORDERING INFORMATION			Screw Size	Weight per Pair Ounces
		Chrome Plated Brass Display Pkg.-5 bags 1 Pr. per bag	Plain Brass Std. Pkg.-5 prs. OEM Pkg.-50 prs.	Chrome Plated Brass Std. Pkg.-5 prs. OEM Pkg.-50 prs.		
3¾	¾	957 DP CHR	957 000 PLB	957 000 CHR	8	4



## HASP FIG. 998

**Bronze  
Plain or Chrome Plated**



Fig. 998

Length Closed Inches	Width Inches	Padlock Clearance Inches	ORDERING INFORMATION			Screw Size	Weight Ounces
			Chrome Plated Bronze Display Pkg.-10 bags 1 Pc. per bag	Plain Bronze Standard Pkg.-10 pcs.	Chrome Plated Bronze Standard Pkg.-10 pcs.		
2	1	⅜	998 DP1 CHR	998 001 PLB	998 001 CHR	6	2
3	1	⅜	998 DP2 CHR	998 002 PLB	998 002 CHR	6	3

Spare Plain Keeper, Cat. No. 959 000 PLB.  
Spare Chrome Keeper, Cat. No. 959 000 CHR.





Fig. 1198

## HASP FIG. 1198

Chrome Plated Zinc

### ORDERING INFORMATION

Length Closed Inches	Width Inches	Padlock Clearance Inches	Display Pkg.-10 bags 1 Pc. per bag	Standard Pkg.-10 pcs.	Screw Size	Weight Ounces
2	1	1/4	1198 DP1 CHR	1198 001 CHR	6	1 1/2
3	1	1/4	1198 DP2 CHR	*1198 002 CHR	6	2 1/4
3 3/4	1	1/4	1198 DP3 CHR	1198 003 CHR	6	2 1/2

Spare Keeper, Cat. No. 1261 DP CHR.

\*OEM Pkg.-25 pcs.

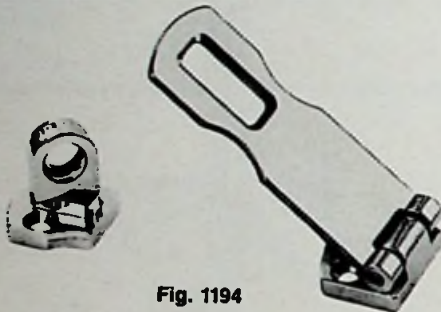

Fig. 1194

## SWIVEL EYE HASP FIG. 1194

Chrome Plated Zinc

Padlock Eye Swivels to Act as a Latch.

### ORDERING INFORMATION

Length Closed Inches	Width Inches	Padlock Clearance Inches	Display Pkg.-10 bags 1 Pc. per bag	Std. Pkg.-10 pcs. OEM Pkg.-50 pcs.	Screw Size	Weight Ounces
3	1	1 1/32	1194 DP CHR	1194 000 CHR	6	2 1/2

Spare Keeper, Cat. No. 1194 000 99A.

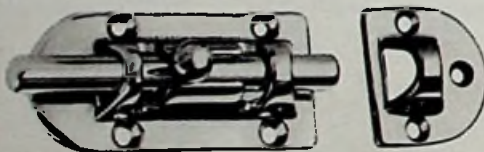

Fig. 947

## BARREL BOLT FIG. 947

Cast Bronze  
Plain or Chrome Plated

Supplied with Friction Pad to Eliminate Rattle  
and Provide Smooth Operation.

### ORDERING INFORMATION

Dimensions Overall Inches	Chrome Plated Bronze Display Pkg.-5 cds. 1 Pc. per card	Plain Bronze Std. Pkg.-5 pcs. OEM Pkg.-25 pcs.	Chrome Plated Bronze Std. Pkg.-5 pcs. OEM Pkg.-25 pcs.	Weight Ounces
3 1/16 x 1 1/16	947 DP1 CHR	947 001 PLB	947 001 CHR	4
4 5/16 x 1 1/16	947 DP2 CHR	947 002 PLB	947 002 CHR	4
5 1/4 x 1 1/16	947 DP3 CHR	*947 003 PLB	947 003 CHR	5

\*No O.E.M. Pkg. Available.

Screw Size #6.



## BARREL BOLT FIG. 1244

**Chrome Plated Zinc**

Integral Friction Pad Eliminates Rattle  
and Provides Smooth Operation.



Fig. 1244

### ORDERING INFORMATION

Dimensions	Display Pkg.-5 cds.	Std. Pkg.-5 pcs.	Screw	Weight
Overall	1 Pc. per card	OEM Pkg.-25 pcs.	Size	Ounces
Inches	1244 DP CHR	1244 000 CHR	6	3
3 $\frac{3}{8}$ x 1 $\frac{1}{4}$				



## SHIP BOLT FIG. 1053

**Chrome Plated Bronze**

Supplied with Brass Friction Spring to Eliminate Rattle  
and Provide Smooth Operation.

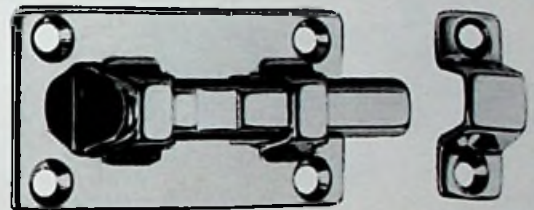

Fig. 1053

### ORDERING INFORMATION

Dimensions	Display Pkg.-5 cds.	Std. Pkg.-5 pcs.	Screw	Weight
Overall	1 Pc. per card	OEM Pkg.-25 pcs.	Size	Ounces
Inches	1053 DP CHR	1053 000 CHR	6	1 $\frac{3}{4}$
2 $\frac{5}{8}$ x 1 $\frac{1}{4}$				



## CABIN DOOR HOOK FIG. 956

**Cast Bronze**  
**Plain or Chrome Plated**

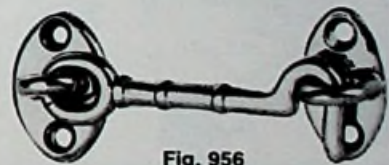

Fig. 956

### ORDERING INFORMATION

Length Hook Inches	Chrome Plated Bronze	Plain Bronze Standard	Chrome Plated Bronze Standard	Chrome OEM Pkg.	Weight Ounces
	Display Pkg.-5 bags 1 Pc. per bag	Pkg.-5 pcs.	Pkg.-5 pcs.		
1 $\frac{1}{2}$	956 DP1 CHR	956 001 PLB	956 001 CHR	50	1
2	956 DP2 CHR	956 002 PLB	956 002 CHR	50	1 $\frac{1}{2}$
2 $\frac{1}{2}$	956 DP3 CHR	956 003 PLB	956 003 CHR	50	1 $\frac{3}{4}$
3	956 DP4 CHR	956 004 PLB	956 004 CHR	50	2
3 $\frac{1}{2}$	956 DP5 CHR	956 005 PLB	956 005 CHR	—	2 $\frac{1}{2}$
4	956 DP6 CHR	956 006 PLB	956 006 CHR	—	3
5	956 DP7 CHR	956 007 PLB	956 007 CHR	—	3 $\frac{1}{2}$
6	956 DP8 CHR	956 008 PLB	956 008 CHR	25	5

Screw Size #6.

Spare Plain Bronze Keeper, Cat. No. 959 000 PLB.

Spare Chrome Keeper, Cat. No. 959 000 CHR.





Fig. 1199

## CABIN DOOR HOOK FIG. 1199

Chrome Plated Zinc

### ORDERING INFORMATION

Length Hook Inches	Display Pkg.-20 bags 1 Pc. per bag	Std. Pkg.-20 pcs. OEM Pkg.-50 pcs.	Screw Size	Weight Ounces
1¾	1199 DP1 CHR	1199 001 CHR	6	1¼
2¼	1199 DP2 CHR	1199 002 CHR	6	1¾
3	1199 DP3 CHR	1199 003 CHR	6	1½
4	1199 DP4 CHR	1199 004 CHR	6	1¾

Spare Keeper, Cat. No. 1261 DP CHR.



Fig. 1287

## CABIN DOOR HOOK FIG. 1287

Chrome Plated Zinc

Patent No. 197,531

### ORDERING INFORMATION

Length Hook Inches	Display Pkg.-20 bags 1 Pc. per bag	Std. Pkg.-20 pcs. OEM Pkg.-50 pcs.	Screw Size	Weight Ounces
2	1287 DP1 CHR	1287 001 CHR	6	1¼
2½	1287 DP2 CHR	1287 002 CHR	6	1½
3	1287 DP3 CHR	1287 003 CHR	6	1¾

Spare Keeper, Cat. No. 1261 DP CHR.

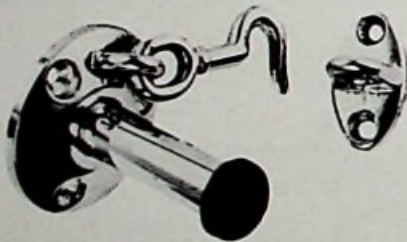

Fig. 574

## DOOR STOP AND HOLDER FIG. 574

Chrome Plated Bronze  
Rubber Bumper

### ORDERING INFORMATION

Length Inches	O.D. Inches	Display Pkg.-5 cds. 1 Pc. per card	Std. Pkg.-5 pcs. OEM Pkg.-25 pcs.	Stop Screw Size	Keeper Screw Size	Weight Ounces
2¾	1¾	574 DP1 CHR	574 001 CHR	8	6	4½
3¼	1¾	574 DP2 CHR	574 002 CHR	8	6	5½

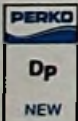

Fig. 1177

## DOOR STOP FIG. 1177

Chrome Plated Zinc  
Rubber Bumper

### ORDERING INFORMATION

Length Inches	O.D. Inches	Display Pkg.-5 bags 1 Pc. per bag	Std. Pkg.-5 pcs. OEM Pkg.-50 pcs.	Screw Size	Weight Ounces
1	1¼	1177 DP CHR	1177 000 CHR	4	1





## DOOR HOLDER FIG. 1065

**Stainless Steel Clip  
Chrome Plated Zinc Arrow**

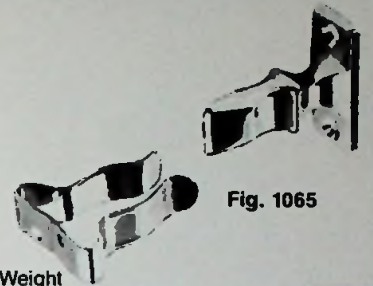

Fig. 1065

Dimensions		ORDERING INFORMATION				
Arrow Base	Clip Base	Projection	Display Pkg.-5 bags	Standard Pkg.-5 pcs.	Screw Size	Weight Ounces
Inches	Inches	Inches	1 Pc. per bag			
1 5/8 x 3/4	1 3/8 x 7/16	1 3/4	1065 DP CHR	1065 000 CHR	8	2



## DOOR CATCH FIG. 554

**White Plastic**

**Stainless Steel Spring  
Chrome Plated Brass Screw**



Fig. 554

Dimensions		ORDERING INFORMATION			Weight
Screw Size	Catch	Display Pkg.-25 bags	OEM Pkg.-100 pcs.	Screw Size	per 50 Ounces
Inches	Inches	2 Pcs. per bag			
3/4 x #8	1 1/4 x 5/8	554 DP	554	4 R.H.	4



## DOOR CATCH FIG. 559

**Black Plastic**



Fig. 559

Dimensions		ORDERING INFORMATION			Weight
Stud	Catch	Display Pkg.-25 bags	OEM Pkg.-100 pcs.	Screw Size	per 50 Ounces
Inches	Inches	2 Pcs. per bag			
1 1/8 x 3/8	1 3/8 x 7/8	559 DP	559	4 R.H.	4



## DOOR BUTTONS FIGS. 1216 & 1217

**Chrome Plated Zinc  
Black Plastic Knob**



Figs. 1216 & 1217

Fig. 1216 — Supplied with Phosphor Bronze Tension Spring.

Fig. 1217 — Supplied without Spring and Requires a No. 8 Oval-Head Pivot Screw.

ORDERING INFORMATION					
O.D. Overall Inches	Display Pkg.-10 bags	OEM Pkg.-50 pcs.	Std. Pkg.	Screw Size	Weight Ounces
	1 Pc. per bag				
1 3/4	1216 DP CHR	1216 000 CHR	—	6	1 1/2
1 3/4	_____	1217 000 CHR	10	6	1 1/2

Spare Knob for Both, Cat. No. 1216 000 99A.



## CUPBOARD BOLT FIG. 1101

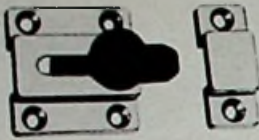

Fig. 1101

**Chrome Plated Zinc  
Black Plastic Slide and Knob**

### ORDERING INFORMATION

Dimensions Overall Inches	Display Pkg.-5 cds. 1 Pc. per card	Std. Pkg.-5 pcs. OEM Pkg.-50 pcs.	Screw Size	Weight Ounces
2 1/8 x 1 1/2	1101 DP CHR	1101 000 CHR	6	2



## CUPBOARD CATCH FIG. 1102

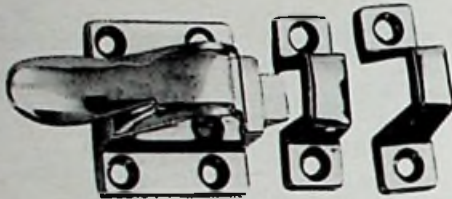

Fig. 1102

Flush Offset

**Chrome Plated Zinc**

**No. 1 Supplied with Flush Strike  
No. 2 Supplied with 3/8 Inch Offset Strike**

### ORDERING INFORMATION

Dimensions Overall Inches	Display Pkg.-5 cds. 1 Pc. per card	Std. Pkg.-5 pcs. OEM Pkg.-50 pcs.	Screw Size	Weight Ounces
1 1/2 x 1 7/8	1102 DP1 CHR	1102 001 CHR	6	3 1/2
1 1/2 x 1 7/8	1102 DP2 CHR	1102 002 CHR	6	3 1/2



## CUPBOARD TURN FIG. 978

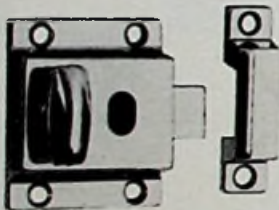

Fig. 978

**Chrome Plated Zinc**

### ORDERING INFORMATION

Dimensions Overall Inches	Display Pkg.-5 cds. 1 Pc. per card	Standard Pkg.-5 pcs.	Screw Size	Weight Ounces
2 1/8 x 2 1/4	978 DP CHR	978 000 CHR	6	5

Spare Strike Plate, Cat. No. 976 000 CHR.

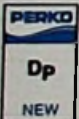

## LATCH FIG. 948

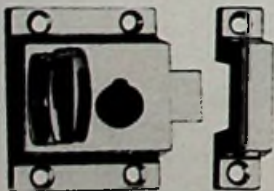

Fig. 948

**Chrome Plated Zinc**

**Sliding Lock Button**

### ORDERING INFORMATION

Dimensions Overall	Display Pkg.-5 cds. 1 Pc. per card	Standard Pkg.-5 pcs.	Screw Size	Weight Ounces
2 1/8 x 2 1/4	948 DP CHR	948 000 CHR	6	5

Spare Strike Plate, Cat. No. 976 000 CHR.

Spare Bevel with Cam, Cat. No. 984 000 CHR.

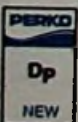

## FLUSH LOCK & LATCH FIGS. 921 & 922

Chrome Plated Zinc

Fig. 921 — Locking Latch with 2 Keys  
Fig. 922 — Non-Locking Latch

Easily Installs in a 1½ Inch Dia. Hole.



For Door Thickness Inches	Dimensions Face Plate Inches	ORDERING INFORMATION		
		Display Pkg.-5 cds. 1 Pc. per card	Std. Pkg.-5 pcs. OEM Pkg.-25 pcs.	Weight Ounces
½-¾	2¼ x 2	921 DP CHR	921 000 CHR	6½
½-¾	2¼ x 2	922 DP CHR	922 000 CHR	6

Spare Cam Bar, Cat. No. 980

Fig. 921



## FLUSH LOCK & LATCH FIGS. 931 & 932

Chrome Plated Zinc and Black Plastic With Brass Stem, Lock Nut and Washer

Fig. 931 — Locking Latch with 2 Keys  
Fig. 932 — Non-Locking Latch

No. 1 with Flush Cam Bar and Flexible Plastic Strike Plate.  
No. 2 with Offset Adjustable Cam Bar.

Detents Indicate Open or Closed Position.  
Easily Installs in a 2 Inch Dia. Hole.



Cat. No. 931 001 BLK



Cat. No. 932 002 BLK

For Door Thickness Inches	Dimensions Face Plate Inches	Adjustment Latch Bar Inches	ORDERING INFORMATION		
			Display Pkg.-5 cds. 1 Pc. per card	Std. Pkg.-5 pcs. OEM Pkg.-25 pcs.	Weight Ounces
¼-1½	2½ x 2½	¾-3	931 DP1 BLK	931 001 BLK	8
¼-1½	2½ x 2½	¾-3	931 DP2 BLK	931 002 BLK	8½
¼-1½	2½ x 2½	¾-3	932 DP1 BLK	932 001 BLK	7
¼-1½	2½ x 2½	¾-3	932 DP2 BLK	932 002 BLK	7½

Spare Flush Cam Bar, Cat. No. 931 001 99A.

Spare Offset Adjustable Cam Bar, Cat. No. 931 002 99A.

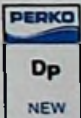

## TRIM RINGS FIGS. 1024 & 1025

Chrome Plated Zinc  
Designed for Use with Figs. 931 & 932

Fig. 1024 — Has Gripper Teeth on the Under Side for Carpeted Surfaces.  
Fig. 1025 — Has a Flat Under Side for Smooth Surfaces.



Flush Lock Not Included

Outside Dimensions Inches	Std. Pkg.-5 pcs. OEM Pkg.-25 pcs.	Weight Ounces
2⅞ x 2⅞	1024 000 CHR	2
2⅞ x 2⅞	1025 000 CHR	2

Fig. 1025



## DETERMINING THE BEVEL REQUIRED ON A LOCK OR LATCH.

**When Standing Outside**

**If the Door Opens Away From You, Then You Need a Lock or Latch with a Regular Bevel.**

**If the Door Opens Toward You, Then You Need a Lock or Latch with a Reverse Bevel.**

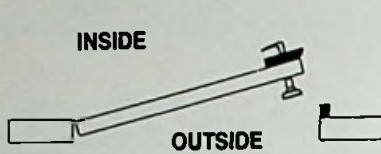

Right Hand Door Showing Regular Bevel Lock With Interchangeable Knob and Lever.

Door Opening Inward.

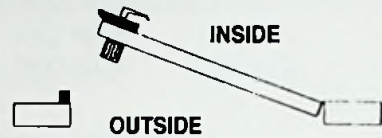

Left Hand Door Showing Regular Bevel Lock With Non-Interchangeable Knob and Lever.

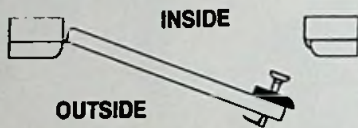

Right Hand Door Showing Reverse Bevel Lock With Interchangeable Knob and Lever.

Door Opening Outward.

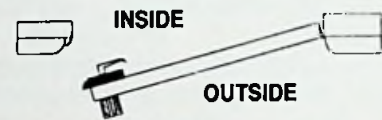

Left Hand Door Showing Reverse Bevel Lock With Non-Interchangeable Knob and Lever.

**All PERKO Lock and Latch Sets May Be Used On Either Right or Left Hand Doors.**



### LATCH FIG. 983

**Chrome Plated Zinc**

**Sliding Lock Button**

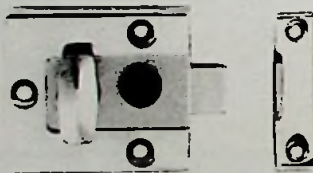

Fig. 983

#### ORDERING INFORMATION

Dimensions Overall	Display Pkg.-5 cds. 1 Pc. per card	Standard Pkg.-5 pcs.	Screw Size	Weight Ounces
2 x 2 1/4	983 DP CHR	983 000 CHR	8	5

Spare Strike Plate, Cat. No. 977 000 CHR.  
Spare Bevel with Cam, Cat. No. 984 000 CHR.



### CUPBOARD TURN FIG. 986

**Chrome Plated Zinc**

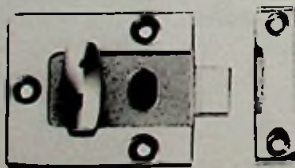

Fig. 986

#### ORDERING INFORMATION

Dimensions Overall Inches	Display Pkg.-5 cds. 1 Pc. per card	Standard Pkg.-5 pcs.	Screw Size	Weight Ounces
2 x 2 1/4	986 DP CHR	986 000 CHR	8	5

Spare Strike Plate, Cat. No. 977 000 CHR.  
Spare Bevel with Cam, Cat. No. 984 000 CHR.





## FLUSH CUP RIM LATCH SETS FIGS. 1239 & 1240

Chrome Plated Zinc

Sliding Lock Button

Fig. 1239 — Regular Bevel with Box Strike  
 Fig. 1240 — Reverse Bevel with Flush Strike

Supplied with Black Plastic Spacer.

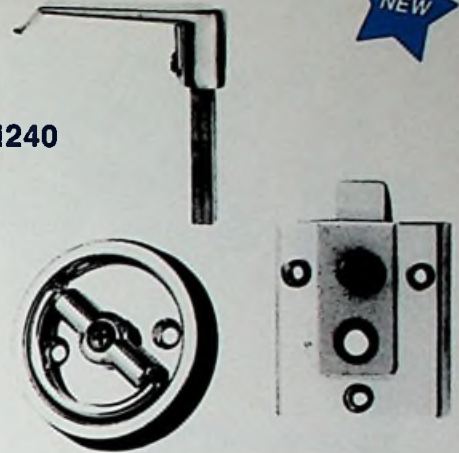

### ORDERING INFORMATION

For Door Thickness Inches	Dimensions Case Inches	O.D. Cup Inches	Fig.		Screw Size Case	Screw Size Cup	Weight Pounds
			1239	1240			
5/8-1	2 x 2 1/4	2 1/4	Std. Pkg.-1 set OEM Pkg.-10 sets	Std. Pkg.-1 set OEM Pkg.-10 sets	8	8	1
			1239 000 CHR	1240 000 CHR			

Spare Box Strike Plate, Cat. No. 977 000 CHR.  
 Spare Flush Strike Plate, Cat. No. 912 000 CHR.

Spare Regular Bevel with Cam, Cat. No. 984 000 CHR.  
 Spare Reverse Bevel with Cam, Cat. No. 920 000 CHR.

Fig. 1239 Fig. 1240

## MORTISE LATCH SETS FIGS. 991 & 992

Chrome Plated Zinc

Sliding Lock Button

Fig. 991 — Regular Bevel with Flush Strike  
 Fig. 992 — Reverse Bevel with Flush Strike

### ORDERING INFORMATION

For Door Thickness Inches	Dimensions Case Inches	Dimensions Escutcheon Inches	Fig.		Screw Size	Weight Pounds
			991	992		
1/2-3/4	1 5/8 x 1 5/8	2 x 2 1/4	Std. Pkg.-1 set OEM Pkg.-10 sets	Std. Pkg.-1 set OEM Pkg.-10 sets	6	1
1/2-3/4	1 5/8 x 1 5/8	2 x 2 1/4	991 000 CHR	992 000 CHR	6	1

Spare Strike Plate, Cat. No. 912 000 CHR.  
 Spare Knob and Handle Assembly, Cat. No. 995 000 CHR.

Spare Regular Bevel with Cam, Cat. No. 984 000 CHR.  
 Spare Reverse Bevel with Cam, Cat. No. 920 000 CHR.

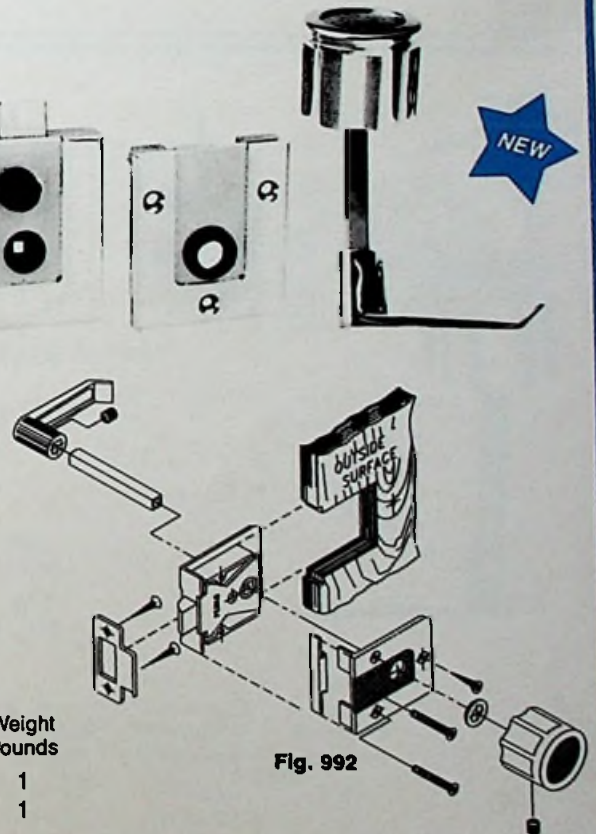
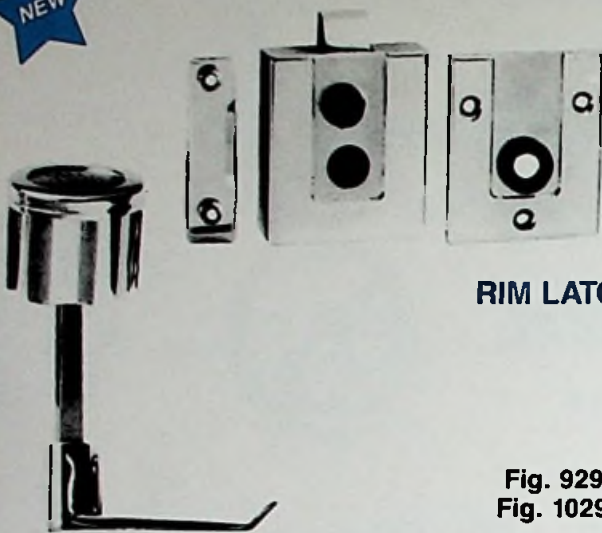

Fig. 992



## RIM LATCH SETS FIGS. 929 & 1029

Chrome Plated Zinc

Sliding Lock Button

Fig. 929 — Regular Bevel with Box Strike

Fig. 1029 — Reverse Bevel with Box Strike

For Door Thickness Inches	Dimensions Case Inches	Dimensions Escutcheon Inches	ORDERING INFORMATION				
			Display Pkg.-5 boxes 1 Set per box	OEM Pkg.-10 sets	Std. Pkg.	Screw Size	Weight Pounds
1/2-1	2 x 2 1/4	2 x 2 1/4	929 DP CHR	929 000 CHR	5	6	3/4
1/2-1	2 x 2 1/4	2 x 2 1/4		1029 000 CHR	1	6	3/4



Spare Strike Plate, Cat. No. 977 000 CHR.

Spare Knob and Handle Assembly, Cat. No. 995 000 CHR.

Spare Regular Bevel with Cam, Cat. No. 984 000 CHR.

Spare Reverse Bevel with Cam, Cat. No. 920 000 CHR.

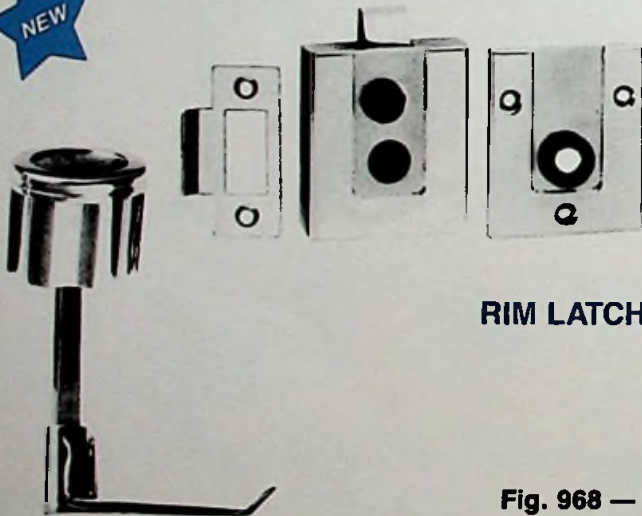

## RIM LATCH SETS FIGS. 968 & 1068

Chrome Plated Zinc

Sliding Lock Button

Fig. 968 — Regular Bevel with Flush Strike

Fig. 1068 — Reverse Bevel with Flush Strike

For Door Thickness Inches	Dimensions Case Inches	Dimensions Escutcheon Inches	ORDERING INFORMATION				
			Display Pkg.-5 boxes 1 Set per box	OEM Pkg.-10 sets	Std. Pkg.	Screw Size	Weight Pounds
1/2-1	2 x 2 1/4	2 x 2 1/4	968 DP CHR	968 000 CHR	5	6	3/4
1/2-1	2 x 2 1/4	2 x 2 1/4		1068 000 CHR	1	6	3/4



Spare Strike Plate, Cat. No. 912 000 CHR.

Spare Knob and Handle Assembly, Cat. No. 995 000 CHR.

Spare Regular Bevel with Cam, Cat. No. 984 000 CHR.

Spare Reverse Bevel with Cam, Cat. No. 920 000 CHR.

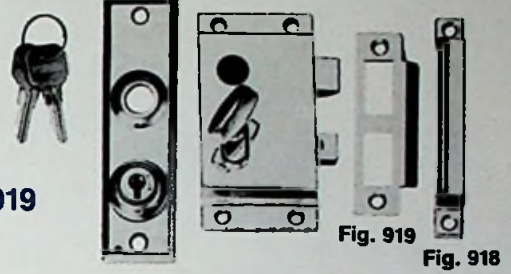

## RIM LOCK SETS FIGS. 918 & 919

Chrome Plated Zinc

Fig. 918 — Regular Bevel with Box Strike  
 Fig. 919 — Reverse Bevel with Flush Strike

Locked by Turn Button from Inside or Key from Outside.



For Door Thickness Inches	Dimensions Case Inches	Dimensions Escutcheon Inches	ORDERING INFORMATION			
			Display Pkg.-5 boxes 1 Set per box	Std. Pkg.-5 sets OEM Pkg.-10 sets	Screw Size	Weight Pounds
5/8-1 3/8	3 7/8 x 2	4 3/8 x 1 1/4	918 DP CHR	918 000 CHR	6	1 1/4
5/8-1 3/8	3 7/8 x 2	4 3/8 x 1 1/4	919 DP CHR	919 000 CHR	6	1 1/4

Spare Box Strike Plate, Cat. No. 918 000 99A.

Spare Flush Strike Plate, Cat. No. 913 000 CHR.

Spare Knob and Handle Assembly, Cat. No. 962 000 CHR.

Spare Bevel with Cam for Both, Cat. No. 920 000 CHR.

Spare Escutcheon Plate with Keys, Cat. No. 953 000 CHR.

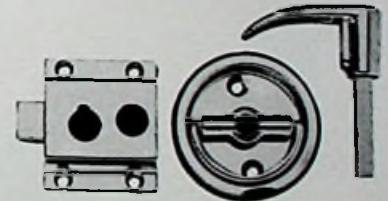

## FLUSH CUP RIM LATCH SETS FIGS. 1279 & 1280

Chrome Plated Zinc

Sliding Lock Button

Fig. 1279 — Regular Bevel with Box Strike  
 Fig. 1280 — Reverse Bevel with Flush Strike

Supplied with Black Plastic Spacer.

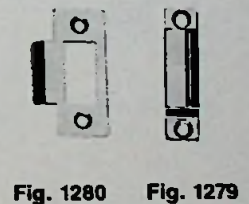

For Door Thickness Inches	Dimensions Case Inches	O.D. Cup Inches	ORDERING INFORMATION		Screw Size Case	Screw Size Cup	Weight Pounds
			Fig. 1279 Std. Pkg.-1 set OEM Pkg.-10 sets	Fig. 1280 Std. Pkg.-1 set OEM Pkg.-10 sets			
3/4-1 1/8	2 1/16 x 1 3/4	2 1/4	1279 000 CHR	1280 000 CHR	6	8	1

Spare Box Strike Plate, Cat. No. 976 000 CHR.

Spare Flush Strike Plate, Cat. No. 912 000 CHR.

Spare Regular Bevel with Cam, Cat. No. 984 000 CHR.

Spare Reverse Bevel with Cam, Cat. No. 920 000 CHR.

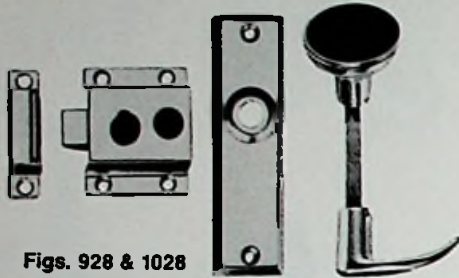

Figs. 928 & 1028

## RIM LATCH SETS FIGS. 928 & 1028

Chrome Plated Zinc

Sliding Lock Button

Fig. 928 — Regular Bevel with Box Strike

Fig. 1028 — Reverse Bevel with Box Strike

For Door Thickness Inches	Dimensions Case Inches	Dimensions Escutcheon Inches	ORDERING INFORMATION				Weight Pounds
			Display Pkg.-5 boxes 1 Set per box	OEM Pkg.-10 sets	Std. Pkg.	Screw Size	
5/8-1 3/8	2 1/8 x 1 3/4	4 3/8 x 1 1/4	928 DP CHR	928 000 CHR	5	6	3/4
5/8-1 3/8	2 1/8 x 1 3/4	4 3/8 x 1 1/4	-----	1028 000 CHR	1	6	3/4



Spare Strike Plate, Cat. No. 976 000 CHR.

Spare Knob and Handle Assembly, Cat. No. 962 000 CHR.

Spare Regular Bevel with Cam, Cat. No. 984 000 CHR.

Spare Reverse Bevel with Cam, Cat. No. 920 000 CHR.

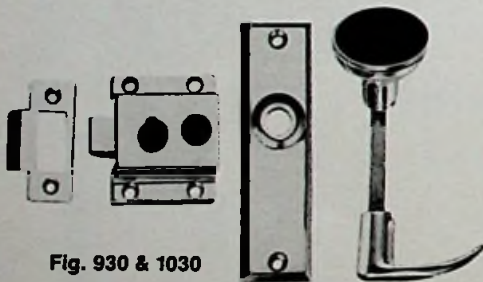

Fig. 930 & 1030

## RIM LATCH SETS FIGS. 930 & 1030

Chrome Plated Zinc

Sliding Lock Button

Fig. 930 — Reverse Bevel with Flush Strike

Fig. 1030 — Regular Bevel with Flush Strike

For Door Thickness Inches	Dimensions Case Inches	Dimensions Escutcheon Inches	ORDERING INFORMATION				Weight Pounds
			Display Pkg.-5 boxes 1 Set per box	OEM Pkg.-10 sets	Std. Pkg.	Screw Size	
5/8-1 3/8	2 1/8 x 1 3/4	4 3/8 x 1 1/4	930 DP CHR	930 000 CHR	5	6	3/4
5/8-1 3/8	2 1/8 x 1 3/4	4 3/8 x 1 1/4	-----	1030 000 CHR	1	6	3/4



Spare Strike Plate, Cat. No. 912 000 CHR.

Spare Knob and Handle Assembly, Cat. No. 962 000 CHR.

Spare Regular Bevel with Cam, Cat. No. 984 000 CHR.

Spare Reverse Bevel with Cam, Cat. No. 920 000 CHR.



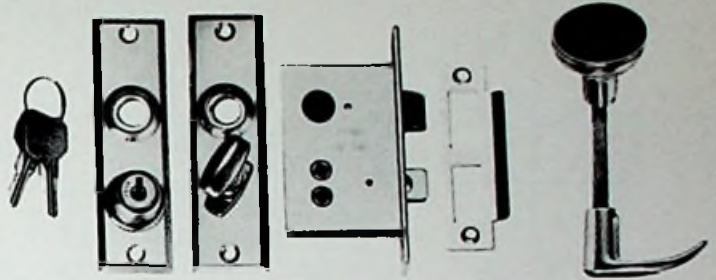

Fig. 927

## MORTISE LOCK SET FIG. 927

**Chrome Plated Zinc**

Locked by Turn Button from Inside or Key from Outside.

### ORDERING INFORMATION

For Door Thickness Inches	Dimensions Case Inches	Dimensions Escutcheon Inches	Std. Pkg.-1 set OEM Pkg.-10 sets	Screw Size	Weight Pounds
1-13/8	2 3/4 x 2	4 3/8 x 1 1/4	927 000 CHR	6	1 1/4

Spare Strike Plate, Cat. No. 913 000 CHR.

Spare Bevel with Cam, Cat. No. 920 000 CHR.

Spare Knob and Handle Assembly, Cat. No. 962 000 CHR.

Spare Escutcheon Plate with Keys, Cat. No. 927 000 99B.

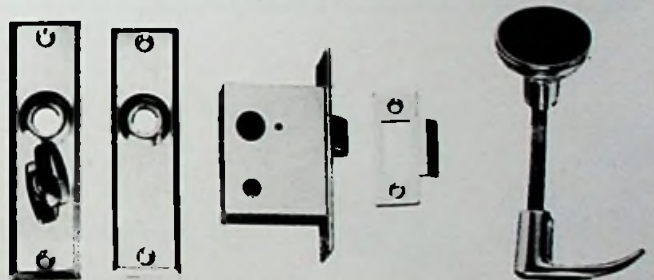

Fig. 960

## MORTISE LATCH SET FIG. 960

**Chrome Plated Zinc**

**Turn Button Lock**

### ORDERING INFORMATION

For Door Thickness Inches	Dimensions Case Inches	Dimensions Escutcheon Inches	Std. Pkg.-1 set OEM Pkg.-10 sets	Screw Size	Weight Pounds
1-13/8	2 1/4 x 1 13/16	4 3/8 x 1 1/4	960 000 CHR	6	1

Spare Strike Plate, Cat. No. 912 000 CHR.

Spare Bevel with Cam, Cat. No. 920 000 CHR.

Spare Knob and Handle Assembly, Cat. No. 962 000 CHR.

## TUBULAR LATCH SET FIG. 567

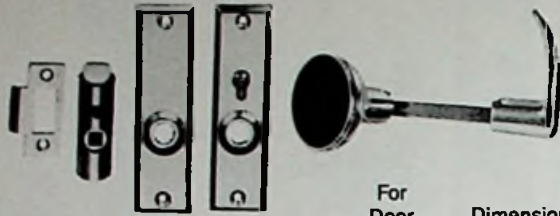

Fig. 567

Chrome Plated Zinc

Sliding Lock Button

For Door Thickness Inches	Dimensions Escutcheon Inches	O.D. Tube Inches	Display Pkg.-5 cds. 1 Set per card	ORDERING INFORMATION	Std. Pkg.-5 sets OEM Pkg.-10 sets	Screw Size	Weight Pounds
1-13/8	4 3/8 x 1 1/4	3/4	567 DP CHR		567 000 CHR	6	3/4

Spare Strike Plate, Cat. No. 912 000 CHR.  
Spare Knob and Handle Assembly, Cat. No. 962 000 CHR.

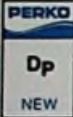

## PULL AND LATCH ASSEMBLY FIG. 938

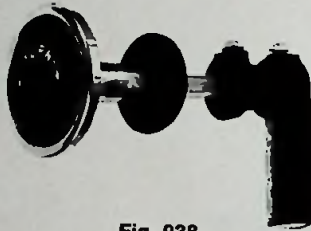
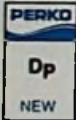

Fig. 938

Chrome Plated Zinc  
Black Plastic Insert  
Brass Stem

O.D. Knob inches	Max. Panel Thickness Inches	Display Pkg.-5 cds. 1 Pc. per card	ORDERING INFORMATION	Std. Pkg.-5 pcs. OEM Pkg.-50 pcs.	Weight Ounces
1 1/2	1 1/8	938 DP CHR		938 000 CHR	2

Spare Cam Bar, Cat. No. 938 000 99A.



## ELBOW CATCH FIG. 1056



Fig. 1056

Chrome Plated Zinc  
Stainless Steel Spring

Dimensions Inches	Display Pkg.-10 bags 1 Pc. per bag	ORDERING INFORMATION	Std. Pkg.-10 pcs. OEM Pkg.-50 pcs.	Screw Size	Weight Ounces
1 1/8 x 9/16	1056 DP CHR		1056 000 CHR	6	3/4



## ELBOW CATCH FIG. 1021



Fig. 1021

Black Plastic  
Integral Spring

Dimensions Inches	Display Pkg.-25 bags 2 Pcs. per bag	ORDERING INFORMATION	OEM Pkg.-100 pcs.	Screw Size	Weight Ounces
1 3/16 x 5/8	1021 DP BLK		1021 000 BLK	6	1/2



## KNOB FIG. 925

**Chrome Plated Brass  
Stainless Steel Screw**



Fig. 925

### ORDERING INFORMATION

O.D. Inches	Max. Panel Thickness Inches	Display Pkg.-10 bags 1 Pc. per bag	Std. Pkg.-10 pcs. OEM Pkg.-50 pcs.	Weight Ounces
1	1 1/8	925 DP CHR	925 000 CHR	1 1/2



## KNOB FIG. 926

**Chrome Plated Zinc  
Stainless Steel Screw  
Black Plastic Insert**



Fig. 926

### ORDERING INFORMATION

O.D. Inches	Max. Panel Thickness Inches	Display Pkg.-10 bags 1 Pc. per bag	Std. Pkg.-10 pcs. OEM Pkg.-100 pcs.	Weight Ounces
1 1/8	1 1/8	926 DP0 CHR	926 000 CHR	3/4
1 1/2	1 1/8	926 DP1 CHR	926 001 CHR	1



## FLUSH RING CATCH FIG. 1051

**Chrome Plated Zinc  
Phosphor Bronze Spring**

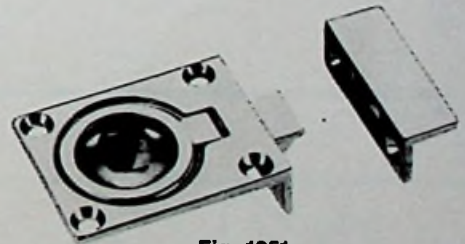

Fig. 1051

### ORDERING INFORMATION

Dimensions Overall Inches	Display Pkg.-10 bags 1 Pc. per bag	Std. Pkg.-10 pcs. OEM Pkg.-25 pcs.	Screw Size	Weight Ounces
2 1/4 x 1 3/8	1051 DP CHR	1051 000 CHR	6	1 1/2





Fig. 841

## FLUSH RING PULL FIG. 841

Chrome Plated Zinc

### ORDERING INFORMATION

Dimensions Face Plate Inches	Display Pkg.-10 bags 1 Pc. per bag	Std. Pkg.-10 pcs. OEM Pkg.-50 pcs.	Screw Size	Weight Ounces
1 3/4 x 1 3/4	841 DP CHR	841 000 CHR	6	1



Dp



Fig. 1232

## FLUSH RING PULL FIG. 1232

Chrome Plated Zinc

### ORDERING INFORMATION

O.D. Face Plate Inches	Display Pkg.-5 bags 1 Pc. per bag	Std. Pkg.-5 pcs. OEM Pkg.-50 pcs.	Screw Size	Weight Ounces
1 5/8	1232 DP1 CHR	1232 001 CHR	6	1
2	1232 DP2 CHR	1232 002 CHR	6	1 1/2



Dp



Fig. 1103

## FLUSH RING PULL FIG. 1103

Chrome Plated Bronze

### ORDERING INFORMATION

Dimensions Face Plate Inches	Display Pkg.-5 cds. 1 Pc. per card	Std. Pkg.-5 pcs. OEM Pkg.-50 pcs.	Screw Size	Weight Ounces
2 5/16 x 2	1103 DP CHR	1103 000 CHR	8	3 1/2



Dp



Fig. 575

## FLUSH LIFTING PULL FIG. 575

Chrome Plated Bronze

### ORDERING INFORMATION

Dimensions Face Plate Inches	Display Pkg.-10 cds. 1 Pc. per card	Std. Pkg.-10 pcs. OEM Pkg.-50 pcs.	Screw Size	Weight Ounces
2 5/8 x 2	575 DP CHR	575 000 CHR	8	3



Dp

## FLUSH PULL FIG. 1221

**Chrome Plated Zinc  
Black Plastic Finishing Flange**

Spring Loaded, Can be Mounted Horizontally or Vertically.

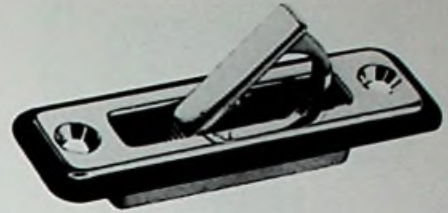

Fig. 1221

### ORDERING INFORMATION

Dimensions	Display Pkg.-5 bags	Std. Pkg.-5 pcs.	Screw	Weight
Flange	1 Pc. per bag	OEM Pkg.-50 pcs.	Size	Ounces
Inches				
3/4 x 3/4	1221 DP CHR	1221 000 CHR	8	3



## FLUSH RING PULLS FIGS. 1286 & 1288

**Chrome Plated Zinc**

**Fig. 1286 — For Surface Mounting with Black Plastic Spacer.  
Fig. 1288 — For Flush Mounting, Easily Installs in a 2 Inch Dia. Hole.**



Fig. 1286

### ORDERING INFORMATION

O.D. Cup	Display Pkg.-5 bags	Standard Pkg.-5 pcs.	Screw	Weight
Inches	1 Pc. per bag		Size	Ounces
2 1/4	1286 DP CHR	1286 000 CHR	8	3 1/2
2 1/4	1288 DP CHR	1288 000 CHR	8	3 1/2



## FLUSH LIFTING HANDLE FIG. 776

**Bronze  
Plain or Chrome Plated**

Size No. 2 (not shown) Has All Mounting Holes at Corners.



Fig. 776

### ORDERING INFORMATION

Dimensions Face Plate Inches	Dimensions Inside Handle Inches	Chrome Plated Bronze	Plain Bronze Standard	Chrome Plated Bronze	Weight Ounces
		Display Pkg.-5 cds. 1 Pc. per card	Pkg.-5 pcs.	Std. Pkg.-5 pcs. OEM Pkg.-25 pcs.	
3 x 2 1/4	1 7/8 x 1	776 DP1 CHR	776 001 PLB	776 001 CHR	3 1/2
3 3/4 x 2 3/4	2 3/16 x 1 3/16	776 DP2 CHR	776 002 PLB	776 002 CHR	5 1/2



## FLUSH LIFTING HANDLE FIG. 1220

**Chrome Plated Zinc**



Fig. 1220

### ORDERING INFORMATION

Dimensions Face Plate Inches	Dimensions Inside Handle Inches	Display Pkg.-5 cds. 1 Pc. per card	Std. Pkg.-5 pcs. OEM Pkg.-50 pcs.	Screw Size	Weight Ounces
3 x 2 1/4	1 7/8 x 1	1220 DP CHR	1220 000 CHR	8	3



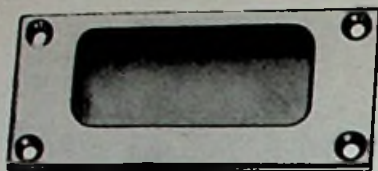

Fig. 1110

## FLUSH PULL FIG. 1110

Chrome Plated Zinc

### ORDERING INFORMATION

Dimensions Face Plate Inches	Depth Inches	Display Pkg.-5 bags 1 Pc. per bag	Std. Pkg.-5 pcs. OEM Pkg.-50 pcs.	Screw Size	Weight Ounces
3 <sup>1</sup> / <sub>16</sub> x 1 <sup>1</sup> / <sub>16</sub>	7/16	1110 DP CHR	1110 000 CHR	6	3

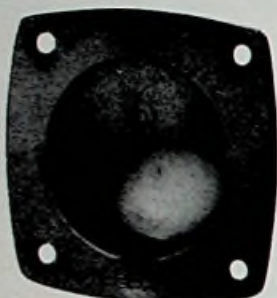

Fig. 1016

## FLUSH PULL FIG. 1016

Plastic  
Black or White

Easily Installs in a 1<sup>3</sup>/<sub>4</sub> Inch Dia. Hole.

### ORDERING INFORMATION

Color	Dimensions Face Plate Inches	Depth Inches	Display Pkg.-10 bags 1 Pc. per bag	OEM Pkg.-100 pcs.	Screw Size	Weight Ounces
Black	2 <sup>1</sup> / <sub>4</sub> x 2 <sup>1</sup> / <sub>4</sub>	1 <sup>5</sup> / <sub>16</sub>	1016 DP BLK	1016 000 BLK	6	1
White	2 <sup>1</sup> / <sub>4</sub> x 2 <sup>1</sup> / <sub>4</sub>	1 <sup>5</sup> / <sub>16</sub>	1016 DP WHT	1016 000 WHT	6	1



Fig. 958

## PULL FIG. 958

Chrome Plated Zinc

### ORDERING INFORMATION

Width Overall Inches	Width Inside Inches	Display Pkg.-10 bags 1 Pc. per bag	Standard Pkg.-10 pcs.	Weight Ounces
3 <sup>3</sup> / <sub>16</sub>	2 <sup>5</sup> / <sub>16</sub>	958 DP CHR	958 000 CHR	1

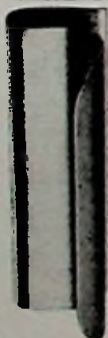

Fig. 954

## SLIDING WINDOW HANDLE FIG. 954

Stainless Steel

### ORDERING INFORMATION

For Glass Thickness Inches	Length Overall Inches	Display Pkg.-5 bags 1 Pc. per bag	Standard Pkg.-5 pcs.	Weight Ounces
1/4	3	954 DP STS	954 000 STS	1



## SLIDING WINDOW STOP FIG. 935

**Chrome Plated Zinc  
Plastic Cover on Stopping Plate**

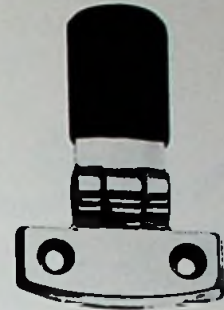

Fig. 935



Dimensions Mounting Plate Inches	Length Stopping Plate Inches	ORDERING INFORMATION			
		Display Pkg.-5 bags 1 Pc. per bag	Std. Pkg.-5 pcs. OEM Pkg.-50 pcs.	Screw Size	Weight Ounces
1 7/8 x 3/4	1 1/2	935 DP CHR	935 000 CHR	8	2

## SLIDING WINDOW LOCK & ANTI-RATTLER FIG. 937

**Chrome Plated Zinc  
Black Plastic Knob and Tip**



Fig. 937



Height Overall Inches	Dimensions Mounting Plate Inches	Adjustment Inches	ORDERING INFORMATION			
			Display Pkg.-5 bags 1 Pc. per bag	Standard Pkg.-5 pcs.	Screw Size	Weight Ounces
1 5/8	1 x 5/8	1 1/8	937 DP CHR	937 000 CHR	6	1 1/4

Spare Black Plastic Tip, Cat. No. 944.

## SLIDING WINDOW LOCK & ANTI-RATTLER FIG. 934

**Chrome Plated Zinc  
Black Plastic Knob and Tip**

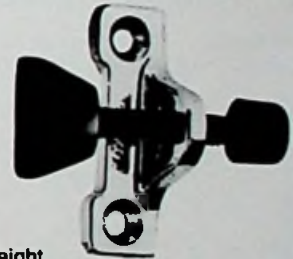

Fig. 934



Height Overall Inches	Dimensions Mounting Plate Inches	Adjustment Inches	ORDERING INFORMATION			
			Display Pkg.-5 bags 1 Pc. per bag	Std. Pkg.-5 pcs. OEM Pkg.-50 pcs.	Screw Size	Weight Ounces
1	2 x 5/8	1 1/8	934 DP CHR	934 000 CHR	6	1 1/4

Spare Black Plastic Tip, Cat. No. 944.

## FASTENER FIG. 719

**Chrome Plated Brass  
Black Plastic Knob with Stainless Steel Stud**



Fig. 719



Length Angle Inches	Width Angle Inches	ORDERING INFORMATION			
		Display Pkg.-5 bags 1 Pc. per bag	Std. Pkg.-5 pcs. OEM Pkg.-25 pcs.	Screw Size	Weight Ounces
1 3/8	1	719 DP CHR	719 000 CHR	8	3

Spare Knob, Cat. No. 719 000 99A.

Spare Angle Bracket, Cat. No. 719 000 99B.

Spare Flat Plate, Cat. No. 719 000 99C.



Fig. 1106

## UTILITY HOOK FIG. 1106

Chrome Plated Zinc

### ORDERING INFORMATION

Projection Inches	Width Base Inches	Display Pkg.-10 bags 1 Pc. per bag	Standard Pkg.-10 pcs.	Screw Size	Weight Ounces
3/4	1	1106 DP CHR	1106 000 CHR	6	3/4



Fig. 975

## UTILITY HOOK FIG. 975

Chrome Plated Zinc

### ORDERING INFORMATION

Projection Inches	Width Base Inches	Display Pkg.-10 bags 1 Pc. per bag	Std. Pkg.-10 pcs. OEM Pkg.-50 pcs.	Screw Size	Weight Ounces
2	1 1/8	975 DP1 CHR	975 001 CHR	6	1
3	1 1/4	975 DP2 CHR	975 002 CHR	6	1 1/2



Fig. 610

## UTILITY HOOK FIG. 610

Chrome Plated Zinc

### ORDERING INFORMATION

Projection Inches	Width Base Inches	Display Pkg.-10 bags 1 Pc. per bag	Std. Pkg.-10 pcs. OEM Pkg.-50 pcs.	Screw Size	Weight Ounces
1 1/8	1 1/8	610 DP CHR	610 000 CHR	6	1/2





## "DURABLE TYPE" FASTENERS FIGS. 869, 896, 898, 901 & 907

Figs. 896, 898, 901 & 907 — Nickel Plated Brass  
 Fig. 869 — Stainless Steel, 5/8 Inch Self Tapping Screw.

For Canvas to Surface, Use Figs. 869, 896 and 898.  
 For Canvas to Canvas, Use Figs. 896, 898, 901 and 907.

### ORDERING INFORMATION

Description	Std. Pkg.-100 pcs. OEM Pkg.-500 pcs.
Stud	869 000 STS
Stud	901 000 NKL
Socket	898 000 NKL
Button	896 000 NKL
Eyelet	907 000 NKL



Socket  
Fig. 898



Stud  
Fig. 901



Button  
Fig. 896



Eyelet  
Fig. 907



Stud  
Fig. 869

## "LIFT TYPE" FASTENERS FIGS. 60, 62, 116, 117 & 118

Figs. 60, 62, 116 & 118 — Nickel Plated Brass  
 Fig. 117 — Stainless Steel, 1/2 Inch Self Tapping Screw.

### ORDERING INFORMATION

Description	Standard Pkg.-100 pcs.
Clinch Stud	60 000 NKL
Clinch Washer	62 000 NKL
Clinch Plate	118 000 NKL
Stud	*117 000 STS
Socket	116 000 NKL

\*OEM Pkg.-500 pcs.



Clinch Washer  
Fig. 62



Clinch Stud  
Fig. 60



Socket  
Fig. 116

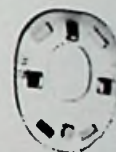

Clinch  
Plate  
Fig. 118



Stud  
Fig. 117

## CURTAIN FASTENERS FIGS. 994, 996 & 997

Nickel Plated Brass

### ORDERING INFORMATION

Description	Standard Pkg.-100 pcs.
Flanged Stud	994 000 NKL
Eyelet	996 000 NKL
Washer	997 000 NKL



Eyelet  
Fig. 996

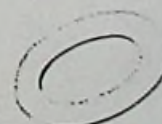

Washer  
Fig. 997



Flanged Stud  
Fig. 994





Socket  
No. 3



Slide  
No. 6  
Ltr. S



Side Plate  
No. 8



Hinge  
No. 1  
Ltr. H



Eye End  
Nos. 5, 9

## CONVERTIBLE TOP FITTINGS FIG. 395

Chrome Plated Zinc  
Stainless Steel Screws

### ORDERING INFORMATION

Description	Display Pkg.-5 bags 2 Pcs. per bag	Screw Size	Avg. Weight Ounces
Hinge for 3/4" fittings	395 DP1 CHR	8	2
Socket for 3/4" tubing	395 DP3 CHR	---	2
Eye End for 3/4" tubing with .049" wall	395 DP5 CHR	---	2
Slide for 3/4" tubing	395 DP6 CHR	---	2
Side Mounting Plate	395 DP8 CHR	10	2
Eye End for 7/8" tubing	395 DP9 CHR	---	2
Slide for 7/8" tubing	395 DPS CHR	---	2
Hinge for 7/8" fittings	395 DPH CHR	8	2



Fig. 1249

## UTILITY HOOK FIG. 1249

Chrome Plated Zinc

### ORDERING INFORMATION

Length Overall Inches	Width Overall Inches	Inside Hook Inches	Display Pkg.-10 bags 5 Pcs. per bag	OEM Pkg.-100 pcs.	Screw Size	Weight Ounces
1 5/16	1/2	1/4	1249 DP CHR	1249 000 CHR	6	1/2

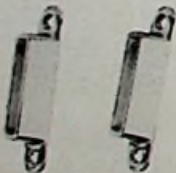

Fig. 578

## BOAT COVER SOCKETS FIG. 578

Chrome Plated Zinc

Will Accommodate 3/8 Inch Wood or Plastic Battens  
Up To 1 3/4 Inches Wide.

### ORDERING INFORMATION

Length Overall Inches	Dimensions Opening Inches	Width Overall Inches	Display Pkg.-10 bags 1 Pr. per bag	OEM Pkg.-50 prs.	Screw Size	Weight per Pair Ounces
3 1/4	1 7/8 x 7/16	5/8	578 DP CHR	578 000 CHR	6	1/2



## THE USAGE OF OUTRIGGERS

by "Hank" Gartner

Outriggers for sport fishing boats were devised some time ago when it was observed that many members of the billfish family would strike sharply at a trolled bait, literally destroying it, then proceed on their way without getting hooked.

With the use of outriggers, the fishing line, after leaving the rod tip, leads to the "trolling pin" in its raised position. After leaving the pin, the line proceeds aft to the proper position in the wake of the boat that the captain deems best to give the proper trolling "action" to the bait being trolled, whether it be mullet, ballyhoo, squid, line bait, etc.

Using outriggers, the fish, after striking vigorously at the trolled bait, releases the line from the pin. This creates a slack loop of line, which in turn lets the struck bait lie motionless in the water.

In theory, the fish believing his prey is stunned, grabs the bait and attempts to make off with it. When the fish runs out of the slack loop of line, he is brought up by the taut line; theoretically he should be hooked.

Outrigger poles should be parallel when in their vertical position. To accomplish this, it may be necessary to build up the deck under the bases of the outrigger pole holders with small teak wedges or fiberglass putty.

It is recommended to have the top guide a few inches down from the extreme tip of the pole. This precludes the possibility of the pin wrapping around and tangling on the pole. Should the owner wish to install dual pins, they should be approximately three feet apart on the same lead line. The small cleats should be secured aft of the outrigger base, thus keeping the "trolling pin" line clear of the outrigger pole and return line.

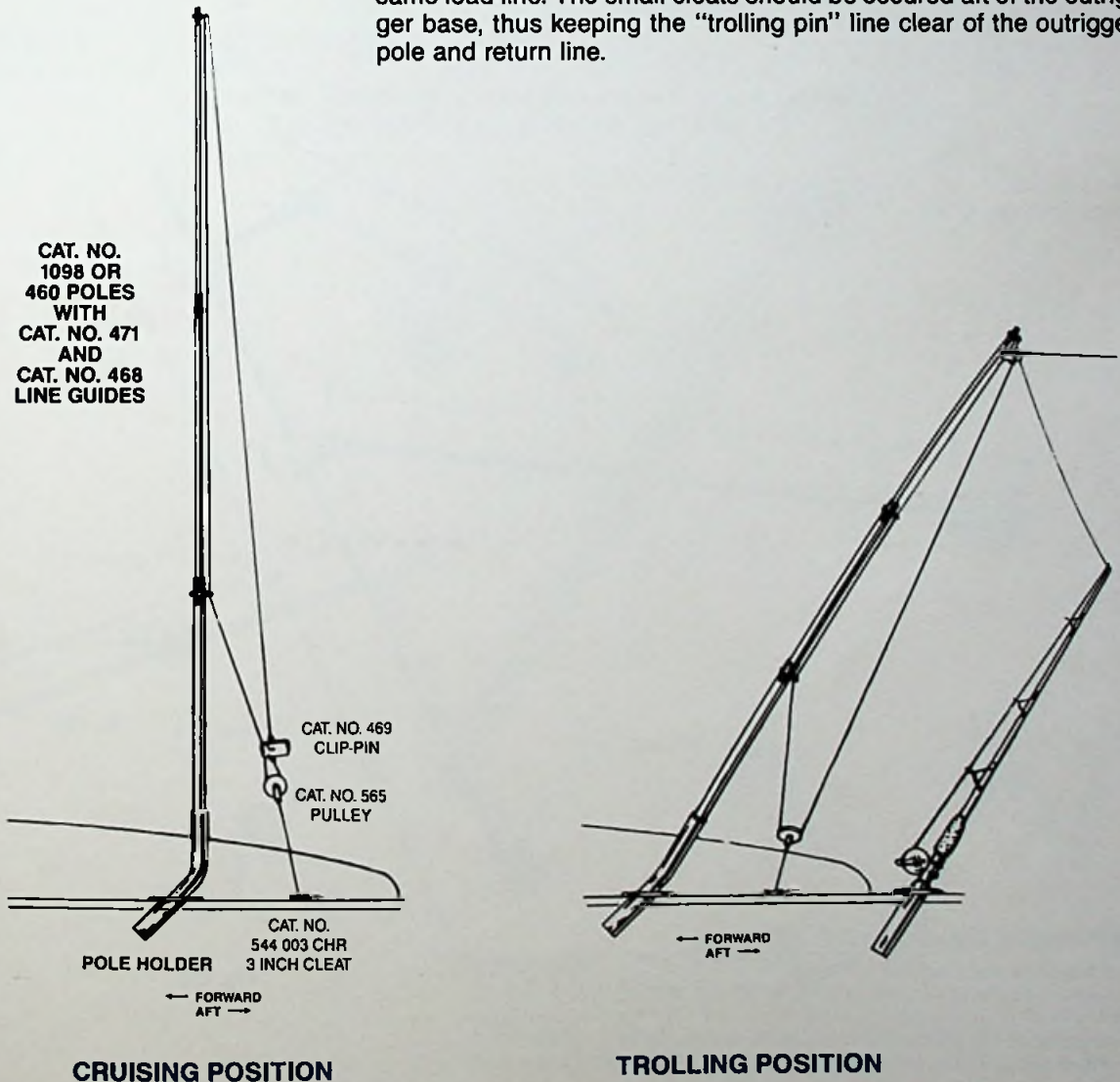

## FLYING BRIDGE RELEASE OUTRIGGER POLE HOLDERS FIG. 425

### STAINLESS STEEL MAIN TUBE AND SUPPORT ARMS CHROME PLATED BRONZE FITTINGS.

An adjustable length, hinged support arm allows the pole holder to be raised and lowered remotely with the use of a line running through an eye on the hinge and attached to the integral eye on the upper stop collar (Fig. No. 409). The main tube and both support arms have heavy swivel mounting bases for versatility of installation and use. Large knobs on the sliding clamps provide ready adjustment for all fishing positions. Stainless steel drift pins on both sliding clamps are pulled to release the pole holder to the down and aft position. Sturdy folding lay down hooks (Fig. No. 410) are included for supporting the outriggers in the down position. A second stop collar (Fig. No. 415) is included for presetting the desired fishing angle. The flying bridge holding bracket (Fig. No. 423) has a heavy swivel mounting base and is hinged for quick release.



#### ORDERING INFORMATION

"A" Length Main Tube Feet	Standard Pkg.-1 pr.	"B" Length Upper Arm Inches	"C" Length Lower Arm Inches	Weight Per Pair Pounds
4	425 004 CHR	23-33	41 $\frac{7}{8}$	65
6	425 006 CHR	35-45	50 $\frac{3}{8}$	75
8	425 008 CHR	46-56	74 $\frac{1}{2}$	95

For Use With Outriggers Cat. Nos. 1098 019 ALU, 1098 019 BLK, 1098 022 ALU,  
1098 022 BLK, 1098 025 ALU and 1098 025 BLK.

Main Tube O.D.-2".      Main Tube I.D.-1.900".  
Mounting Flanges O.D.-4".      Bolt Size- $\frac{1}{4}$ ".

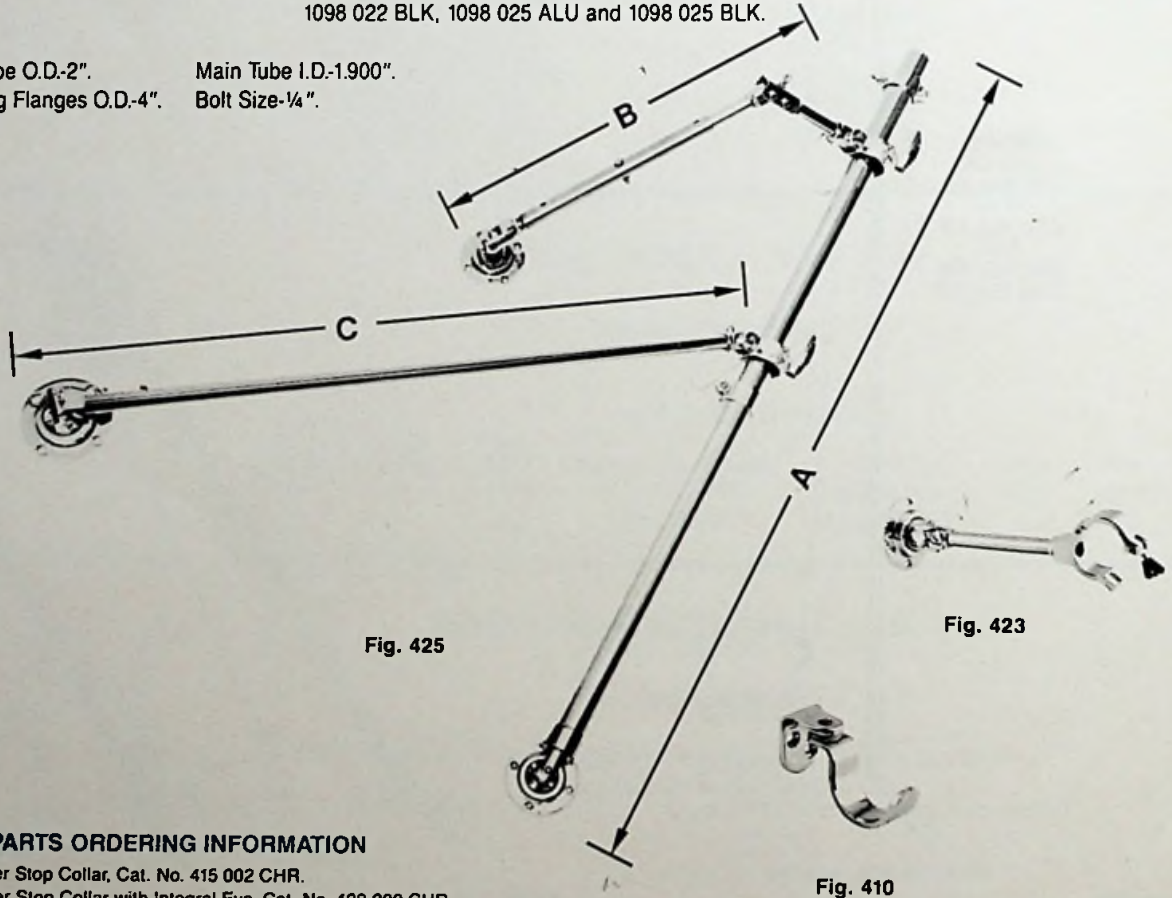

Fig. 425

Fig. 423

Fig. 410

#### SPARE PARTS ORDERING INFORMATION

Spare Lower Stop Collar, Cat. No. 415 002 CHR.  
Spare Upper Stop Collar with Integral Eye, Cat. No. 409 000 CHR.  
Spare Lay Down Hook, Cat. No. 410 002 CHR.  
Spare Knob for Sliding Clamp Assembly, Cat. No. 401 000 CHR.  
Spare Holding Bracket, Cat. No. 423 000 CHR.

## OUTRIGGER POLE HOLDERS FIG. 400

### STAINLESS STEEL MAIN TUBE AND SUPPORT ARMS CHROME PLATED BRONZE FITTINGS.

A large knob on the sliding clamps provide ready adjustment for all fishing positions. All joints swivel for easy installation and use. A stop collar, with an integral eye for the lifting line, is included for presetting the desired fishing angle. Sturdy folding lay down hooks (Fig. No. 410) are also included for supporting the outriggers in the down position. The upper holding bracket (Fig. No. 408) is hinged for quick release.

#### ORDERING INFORMATION

"A" Length Main Tube Feet	Standard Pkg.-1 pr.	"B" Length Upper Arm Inches	"C" Length Lower Arm Inches	Weight Per Pair Pounds
4	400 004 CHR	27 $\frac{1}{4}$	41 $\frac{7}{8}$	59
6	400 006 CHR	38 $\frac{7}{8}$	50 $\frac{3}{8}$	70
8	400 008 CHR	50 $\frac{3}{8}$	74 $\frac{1}{2}$	90

For Use With Outriggers Cat. Nos. 1098 019 ALU, 1098 019 BLK, 1098 022 ALU,  
1098 022 BLK, 1098 025 ALU and 1098 025 BLK.

Main Tube O.D.-2".      Main Tube I.D.-1.900".  
Mounting Flanges O.D.-4".      Bolt Size- $\frac{1}{4}$ ".

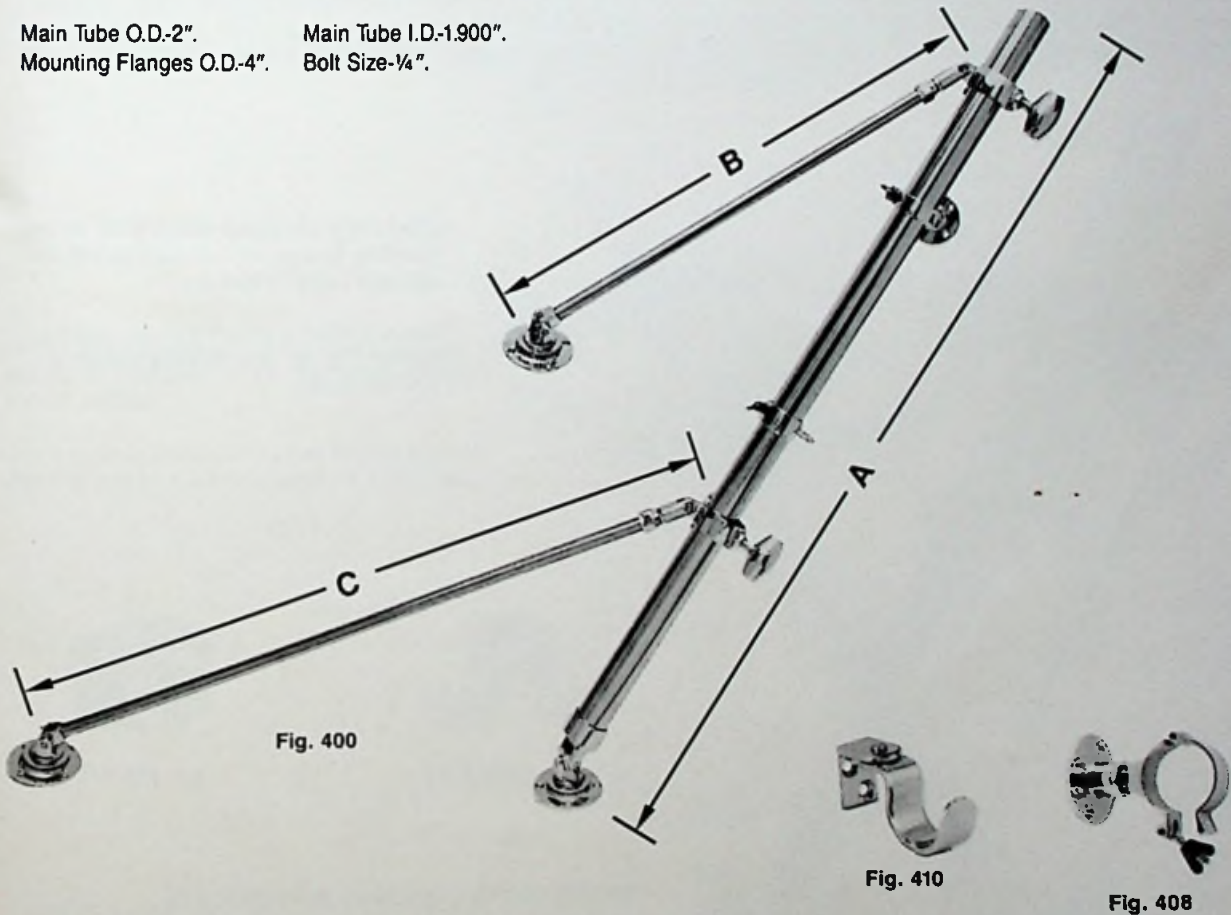

#### SPARE PARTS ORDERING INFORMATION

Spare Stop Collar, Cat. No. 409 000 CHR.  
Spare Lay Down Hook, Cat. No. 410 002 CHR.  
Spare Knob for Sliding Clamp Assembly, Cat. No. 401 000 CHR.  
Spare Holding Bracket, Cat. No. 408 000 CHR.

## OUTRIGGER POLE HOLDERS FIG. 445

### STAINLESS STEEL MAIN TUBE CHROME PLATED BRASS YOKE TUBING AND BRONZE FITTINGS.

A large knob on the sliding clamp provides ready adjustment for all fishing positions. A stainless steel drift pin in the sliding clamp is pulled to release the pole holder to a down and aft position. Features include heavy bidirectional hinged mounting base for easy installation on a horizontal or vertical surface. A stop collar (Fig. No. 415) included for presetting the desired fishing angle. Sturdy folding lay down hooks (Fig. No. 410) are also included for supporting the outriggers in the down position. The mounting yokes may be installed in an inverted position, rather than that shown, to accommodate various installation requirements.

#### ORDERING INFORMATION

Holder Size No.	I.D. Main Tube Inches	"A" Length Main Tube Inches	O.D. Main Tube Inches	Standard Pkg.-1 pr.	"B" Yoke Width Inches	Weight Per Pair Pounds	Bolt Size Inches
1	1.500	20	1 $\frac{5}{8}$	445 001 CHR	11 $\frac{3}{4}$	22	$\frac{1}{4}$
2	1.900	20	2	445 002 CHR	11 $\frac{3}{4}$	24	$\frac{1}{4}$
3	1.900	35	2	445 003 CHR	24	33	$\frac{1}{4}$

Size No. 1 For Use With Outrigger Poles, Cat. Nos. 1098 016 ALU, 1098 016 BLK, 1098 018 ALU and 1098 018 BLK.

Size No. 2 For Use With Outrigger Poles, Cat. Nos. 1098 019 ALU and 1098 019 BLK.

Size No. 3 For Use With Outrigger Poles, Cat. Nos. 1098 019 ALU, 0198 019 BLK, 1098 022 ALU, 1098 022 BLK, 1098 025 ALU and 1098 025 BLK.

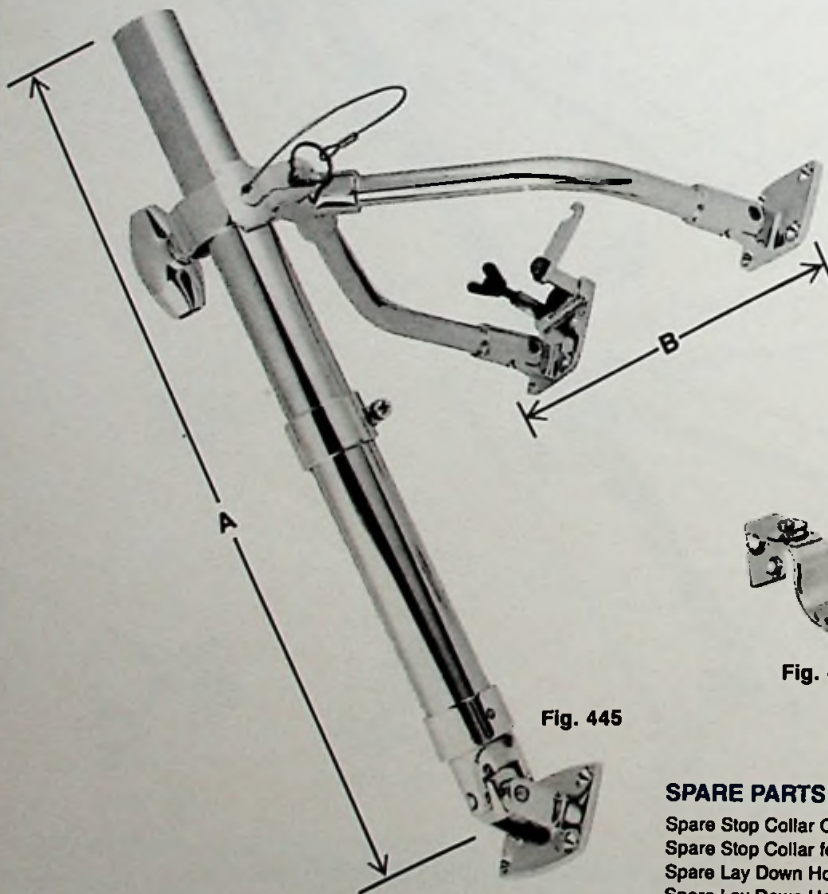

Fig. 445

Sizes 1 and 2 feature a retaining bar on one mounting bracket (as illustrated) to hold the outrigger in the vertical position.

Size 3 features a standard hinged holding bracket (Fig. No. 408) for quick release of the main tube.



Fig. 410



Fig. 415

#### SPARE PARTS ORDERING INFORMATION

Spare Stop Collar Only for Size 1 Holder, Cat. No. 415 001 CHR.

Spare Stop Collar for Size 2 and 3 Holders, Cat. No. 415 002 CHR.

Spare Lay Down Hook for Size 1 Holder, Cat. No. 410 001 CHR.

Spare Lay Down Hook for Size 2 and 3 Holders, Cat. No. 410 002 CHR.

Spare Port Locking Bar Assembly with Stud, Cat. No. 406 P00 99A.

Spare Starboard Locking Bar Assembly with Stud, Cat. No. 406 S00 99A.

Spare Knob for Sliding Clamp Assembly, Cat. No. 401 000 CHR.

## OUTRIGGER POLE HOLDERS FIG. 470

### STAINLESS STEEL MAIN TUBE CHROME PLATED BRASS YOKE TUBING AND BRONZE FITTINGS.

A large knob on the sliding clamp provides ready adjustment for all fishing positions. A stainless steel drift pin in the sliding clamp is pulled to release the pole holder to a down and aft position. Features include a heavy swivel mounting base for easy installation on a horizontal or vertical surface. A stop collar (Fig. No. 415) included for presetting the desired fishing angle. Sturdy folding lay down hooks (Fig. No. 410) are also included for supporting the outriggers in the down position. The mounting yokes may be installed in an inverted position, rather than that shown, to accommodate various installation requirements.

#### ORDERING INFORMATION

Holder Size No.	I.D. Main Tube Inches	"A" Length Main Tube Inches	O.D. Main Tube Inches	Standard Pkg.-1 pr.	"B" Yoke Width Inches	Weight Per Pair Pounds	Bolt Size Inches
1	1.500	20	1 $\frac{5}{8}$	470 001 CHR	11 $\frac{3}{4}$	22	$\frac{1}{4}$
2	1.900	20	2	470 002 CHR	11 $\frac{3}{4}$	24	$\frac{1}{4}$
3	1.900	35	2	470 003 CHR	24	33	$\frac{1}{4}$

Size No. 1 For Use With Outrigger Poles, Cat. Nos. 1098 016 ALU, 1098 016 BLK, 1098 018 ALU and 1098 018 BLK.

Size No. 2 For Use With Outrigger Poles, Cat. Nos. 1098 019 ALU and 1098 019 BLK.

Size No. 3 For Use With Outrigger Poles, Cat. Nos. 1098 019 ALU, 1098 019 BLK, 1098 022 ALU, 1098 022 BLK, 1098 025 ALU and 1098 025 BLK.

Sizes 1 and 2 feature a retaining bar on one mounting bracket (as illustrated) to hold the outrigger in the vertical position.

Size 3 features a standard hinged holding bracket (Fig. No. 408) for quick release of the main tube.



Fig. 415



Fig. 410

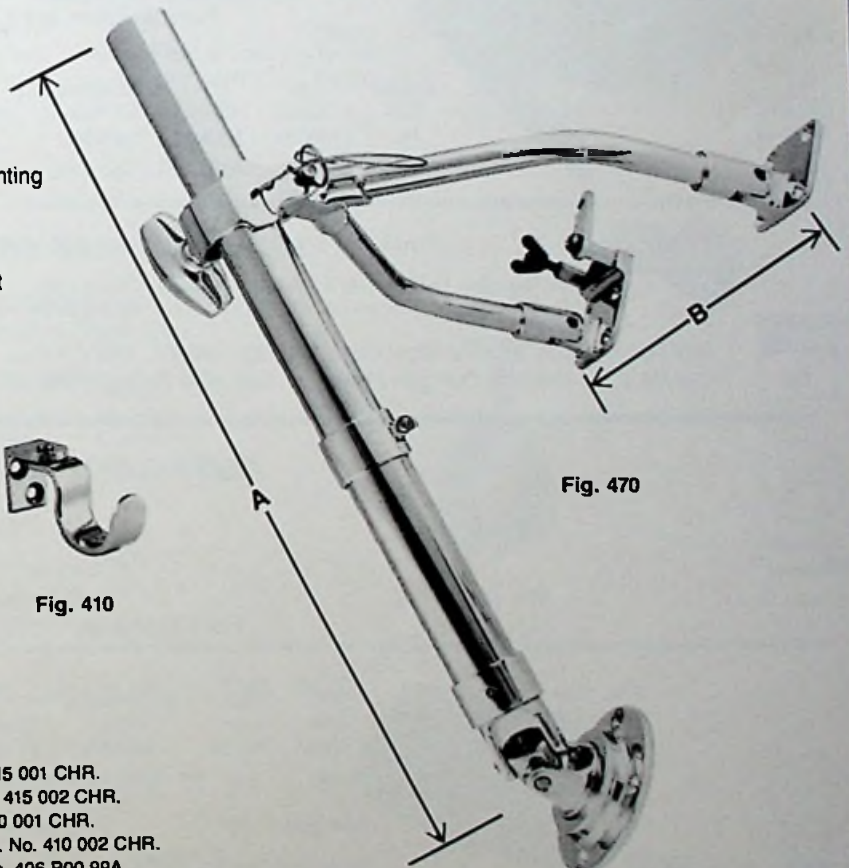

Fig. 470

#### SPARE PARTS ORDERING INFORMATION

Spare Stop Collar Only for Size 1 Holder, Cat. No. 415 001 CHR.

Spare Stop Collar for Size 2 and 3 Holders, Cat. No. 415 002 CHR.

Spare Lay Down Hook for Size 1 Holder, Cat. No. 410 001 CHR.

Spare Lay Down Hook for Size 2 and 3 Holders, Cat. No. 410 002 CHR.

Spare Port Locking Bar Assembly with Stud, Cat. No. 406 P00 99A.

Spare Starboard Locking Bar Assembly with Stud, Cat. No. 406 S00 99A.

Spare Knob for Sliding Clamp Assembly, Cat. No. 401 000 CHR.

## OUTRIGGER POLE HOLDERS

Removable Tubes Lift and Turn to Three Positions: Vertical, Fishing, and Lowered. Universal Tubes May Be Used on Either Side. Supplied in Pairs Consisting of Two Mounts and Two Tubes.

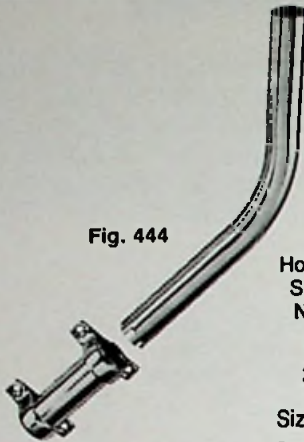

Fig. 444

### OUTRIGGER POLE HOLDERS FIG. 444

#### SIDE MOUNT

Chrome Plated Bronze Brackets  
 Size 1 Tubes are Polished Stainless Steel.  
 Size 2 Tubes are Chrome Plated Brass.

Holder Size No.	I.D. Tube Inches	O.D. Tube Inches	Dimensions Bracket Inches	ORDERING INFORMATION		Weight Per Pair Pounds
				Display Pkg.-5 pkgs. 1 Pr. per pkg.	Standard Pkg.-1 pr.	
1	1.120	1¼	4½ x 3	444 DP1 CHR	444 001 CHR	4½
2	1.500	1½	6½ x 4	-----	444 002 CHR	8¼

Size 1 Bolt Size — ¼". Size 2 Bolt Size — ⅝".

Spare Bracket For Size No. 1, Cat. No. 478 001 CHR. Spare Bracket For Size No. 2, Cat. No. 478 002 CHR.

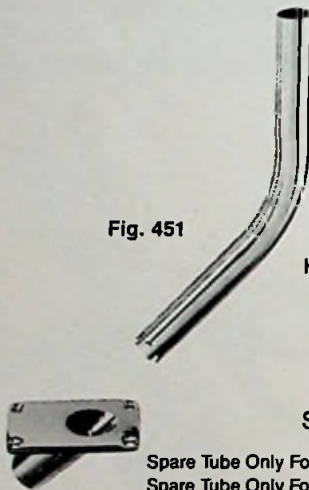

Fig. 451

### OUTRIGGER POLE HOLDERS FIG. 451

#### DECK MOUNT

Chrome Plated Bronze Plates  
 Size 1 Tubes are Polished Stainless Steel.  
 Size 2 Tubes are Chrome Plated Brass.

Holder Size No.	I.D. Tube Inches	O.D. Tube Inches	Dimensions Plate Inches	ORDERING INFORMATION		Weight Per Pair Pounds
				Display Pkg.-5 pkgs. 1 Pr. per pkg.	Standard Pkg.-1 pr.	
1	1.120	1¼	5 x 2½	451 DP1 CHR	451 001 CHR	6⅝
2	1.500	1½	6 x 3½	-----	451 002 CHR	11¼

Size 1 Bolt Size — ¼". Size 2 Bolt Size — ⅝".

Spare Tube Only For Figs. 444 & 451 Size 1, Cat. No. 479 001 STS.  
 Spare Tube Only For Figs. 444 & 451 Size 2, Cat. No. 479 002 CHR.

Spare Plate Only For Size No. 1, Cat. No. 474 001 CHR.  
 Spare Plate Only For Size No. 2, Cat. No. 474 002 CHR.



Size No. 1 For Use With Outrigger Poles, Cat. Nos. 460 015, 1098 011 ALU, 1098 011 BLK, 1098 015 ALU and 1098 015 BLK.  
 Size No. 2 For Use With Outrigger Poles, Cat. Nos. 1098 016 ALU, 1098 016 BLK, 1098 018 ALU and 1098 018 BLK.

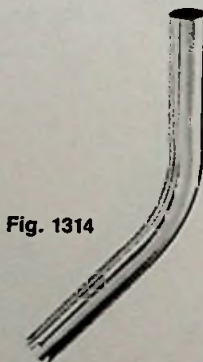

Fig. 1314

### OUTRIGGER POLE HOLDERS FIG. 1314

#### DECK MOUNT

Chrome Plated Zinc Plates\*  
 Stainless Steel Tubes.  
 For Fiberglass Outrigger Poles, Cat. No. 460 015.

I.D. Tube Inches	O.D. Tube Inches	Dimensions Plate Inches	ORDERING INFORMATION		Weight Per Pair Pounds
			Display Pkg.-5 pkgs. 1 Pr. per pkg.	Std. Pkg.-5 prs. OEM Pkg.-10 prs.	
1.120	1¼	5 x 2½	1314 DP CHR	1314 000 CHR	4¾

Bolt Size — ¼".

Spare Tube Only For Fig. 1314, Cat. No. 1321 000 STS.

Spare Plate Only For Fig. 1314, Cat. No. 1320 000 CHR.

\*NOT DESIGNED FOR USE WITH ALUMINUM POLES.





## OUTRIGGER POLES FIG. 460

### TELESCOPING FIBERGLASS With Reinforced Joints

Complete with Tip Roller (Fig. No. 471) and Standard (Fig. No. 468) Line Guides.

For Use With Nos. 444 001 CHR, 451 001 CHR and 1314 000 CHR Holders.

ORDERING INFORMATION					
Open Length Overall Feet	O.D. Base Inches	Closed Length Overall Feet	Number of Sections	Standard Pkg.-1 pr. Cat. No.	Weight Per Pair Pounds
15	1.120	5½	3	460 015	3½

Single Pole only, Cat. No. 460 015 98A.

Fig. 460

Fig. 476

## FIBERGLASS OUTRIGGER KIT FIG. 476

Consists of One Pair of Fig. No. 460 Poles with Fig. No. 471 Tip Roller Guides, Fig. No. 468 Standard Guides and Fig. No. 469 Clips.

Standard Pkg.-3 pr. 476

## OUTRIGGER POLE ROLLER TIP LINE GUIDE FIG. 471

### HIGH IMPACT BLACK PLASTIC With 7/8 Inch O.D. Nylon Sheave

#### ORDERING INFORMATION

I.D. Body Inches	For Use With Outrigger Pole Size	Maximum Rope Size Inches	Display Pkg.-5 cds. 1 Pr. per card	Weight per Pair Ounces
9/16	460 & 476	¼	471 DP1 BLK	1
5/8	1098 011 & 015	¼	471 DP2 BLK	1
¾	1098 016,018,019,022 & 025	¼	471-DP3 BLK	1



Fig. 471

## OUTRIGGER POLE LINE GUIDES FIG. 468

### HIGH IMPACT BLACK PLASTIC With 3/8 Inch I.D. Stainless Steel Eye

#### ORDERING INFORMATION

I.D. Body Inches	Display Pkg.-5 bags 2 Pcs. per bag	Weight per Pair Ounces
9/16	468 DP1 BLK	3
5/8	468 DP2 BLK	3½
¾	468 DP3 BLK	3½
1	468 DP4 BLK	3½
1 1/16	468 DP5 BLK	4
1 5/8	468 DP6 BLK	4½



Fig. 468

## OUTRIGGER TROLLING PIN OR CLIP FIG. 469

### HIGH IMPACT BLACK PLASTIC With Stainless Steel Eyes and Spring

#### ORDERING INFORMATION

Dimensions Inches	Display Pkg.-5 bags 2 Pcs. per bag	Weight Ounces
2¾ x 1¾	469 DP BLK	1½



Fig. 469



## OUTRIGGER POLES FIG. 1098

Silver Anodized Aluminum or Black PERKO•KOTE  
With Black Plastic Insulated Base

Complete with Tip Roller (Fig. No. 471) and  
Standard (Fig. No. 468) Line Guides.

Heavy duty poles for rough water use, sections are threaded for easy assembly.

### ORDERING INFORMATION

"A" Length Overall Feet	"B" Base Diameter Inches	Number of Sections	Silver Standard Pkg.-1 pr. Cat. No.	Black Standard Pkg.-1 pr. Cat. No.	Silver Single Pole Only Cat. No.	Black Single Pole Only Cat. No.	Weight per Pair Pounds
11 1/3	1.120	3	1098 011 ALU	1098 011 BLK	1098 011 99A	1098 B11 99A	4 3/4
15	1.120	4	1098 015 ALU	1098 015 BLK	1098 015 99A	1098 B15 99A	6 1/2
15	1.500	4	1098 016 ALU	1098 016 BLK	1098 016 99A	1098 B16 99A	8 1/4
18 2/3	1.500	5	1098 018 ALU	1098 018 BLK	1098 018 99A	1098 B18 99A	12 5/8
18 2/3	1.900	5	1098 019 ALU	1098 019 BLK	1098 019 99A	1098 B19 99A	12 3/4
22 1/4	1.900	6	1098 022 ALU	1098 022 BLK	1098 022 99A	1098 B22 99A	17 5/8
25 1/2	1.900	7	1098 025 ALU	1098 025 BLK	1098 025 99A	1098 B25 99A	24 5/8



## SPREADERS FIGS. 1114 & 1115

Anodized Aluminum  
Spreader Arms and Eye Bands  
Silver or Gold

Designed for use with our aluminum outrigger poles  
when maximum rigidity is desired.

Supplied in pairs consisting of: spreaders,  
stainless steel cable, eye bands and turnbuckles.

### ORDERING INFORMATION

For Use With Outriggers Cat. No.	Silver Single Spreader Cat. No.	Gold Single Spreader Cat. No.	Silver Double Spreader Cat. No.	Gold Double Spreader Cat. No.
1098 018 ALU & 1098 018 BLK	1114 018	1114 018 GLD	-----	-----
1098 019 ALU & 1098 019 BLK	1114 018	1114 018 GLD	-----	-----
1098 022 ALU & 1098 022 BLK	1114 022	1114 022 GLD	1115 022	1115 G22 GLD
1098 025 ALU & 1098 025 BLK	1114 025	1114 025 GLD	1115 025	1115 G25 GLD

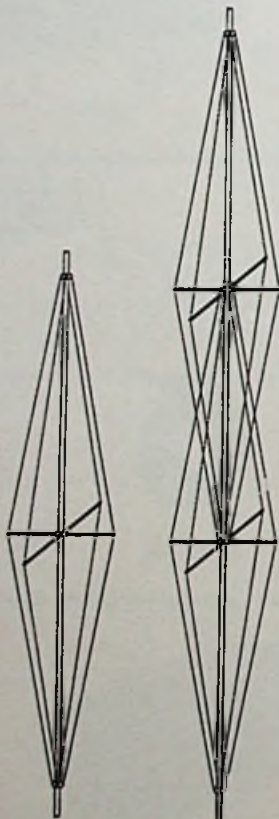
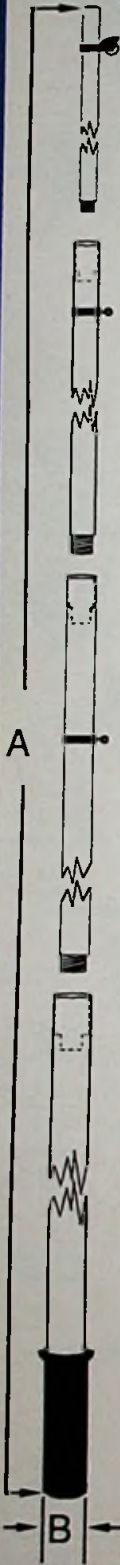

Fig. 1098

Fig. 1114  
SINGLE

Fig. 1115  
DOUBLE

## FISHING ROD HOLDER FIG. 1205

### FLUSH MOUNT

Chrome Plated Zinc Flange,  
Anodized Aluminum Tube  
with Soft Black Flange Gasket and Integral Flip-up Cap.

Fig. 1205

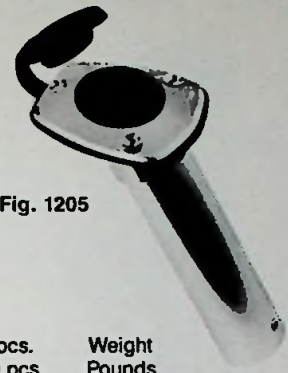

I.D. Tube Inches	O.D. Tube Inches	Length Under Flange Inches	Dimensions Flange Inches	ORDERING INFORMATION		
				Display Pkg.-5 pkgs. 1 Pc. per pkg.	Std. Pkg.-5 pcs. OEM Pkg.-20 pcs.	Weight Pounds
1 5/8	2	8	4 1/4 x 3 1/2	1205 DP CHR	1205 000 CHR	1 1/2

Bolt Size 1/4".



## FISHING ROD HOLDER FIG. 448

### FLUSH MOUNT

Chrome Plated Bronze Flange,  
Chrome Plated Brass Tube.

No. 1 Includes a Soft Black Flange Gasket with Integral Flip-up Cap.  
No. 2 Includes a Liner with Lip Only, as Illustrated.

Fig. 448-1

Fig. 448-2



I.D. Tube Inches	O.D. Tube Inches	Length Under Flange Inches	Dimensions Flange Inches	ORDERING INFORMATION				
				Display Pkg.-5 pkgs. 1 Pc. per pkg.	Std. Pkg. Catalog No.	Std. Pkg.	OEM Pkg.	Weight Pounds
1 5/8	2	8	4 1/4 x 3 1/2	448 DP1 CHR	448 001 CHR	5	10	2
1 7/8	2 1/4	12	4 7/8 x 4	*448 DP2 CHR	448 002 CHR	1	—	3 3/8

Bolt Size 1/4".

\*Display Pkg.-1 card, 1 Pc. per card.

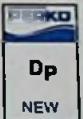

## FISHING ROD HOLDER FIG. 452

### FLUSH MOUNT

Polished Stainless Steel Flange,  
Stainless Steel Tube  
with Soft Black Flange Gasket and Integral Flip-up Cap.

Fig. 452



I.D. Tube Inches	O.D. Tube Inches	Length Under Flange Inches	Dimensions Flange Inches	ORDERING INFORMATION		
				Display Pkg.-5 pkgs. 1 Pc. per pkg.	Std. Pkg.-5 pcs. OEM Pkg.-10 pcs.	Weight Pounds
1 5/8	2	8 1/4	4 1/8 x 3 3/8	452 DP STS	452 000 STS	1 3/8

Bolt Size #10.



#### SPARE PARTS ORDERING INFORMATION

Spare Liner with Lip and Tube, See Fig. 482 DP, Specify Size, Page 192.

Spare Cap and Gasket Kit, See Figs. 480 DP & 481 DP, Specify Type, Page 192.

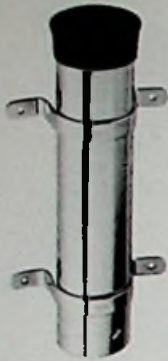

## FISHING ROD HOLDER FIG. 1100

### SIDE MOUNT

Chrome Plated Brass  
with Soft Black Liner.

#### ORDERING INFORMATION

I.D. Tube Inches	O.D. Tube Inches	Length Overall Inches	Width Bracket Inches	Display Pkg.-5 pkgs. 1 Pc. per pkg.	Std. Pkg.-5 pcs. OEM Pkg.-10 pcs.	Weight Pounds
1 $\frac{5}{8}$	2	9	3	1100 DP CHR	1100 000 CHR	1 $\frac{1}{4}$

Bolt Size #8 R.H.

Spare Bracket, Cat. No. 1107 000 CHR.

Spare Liner with Lip and Tube, Cat. No. 483 DP1 BLK.

Fig. 1100



## HEAVY DUTY FISHING ROD HOLDER FIG. 404

### SIDE MOUNT

Chrome Plated Brass and Bronze  
with Soft Black Liner.

#### ORDERING INFORMATION

I.D. Tube Inches	O.D. Tube Inches	Length Overall Inches	Width Bracket Inches	Display Pkg.-5 pkgs. 1 Pc. per pkg.	Std. Pkg. Catalog No.	Std. Pkg.	Weight Pounds
1 $\frac{5}{8}$	2	9	4 $\frac{3}{16}$	404 DP1 CHR	404 001 CHR	5	2
1 $\frac{7}{8}$	2 $\frac{1}{4}$	11	4 $\frac{3}{4}$	*404 DP2 CHR	404 002 CHR	1	3 $\frac{1}{8}$

Bolt Size  $\frac{1}{4}$ ".

\*Display Pkg.-1 card, 1 Pc. per card.

Spare Bracket for 2" Tube, Cat. No. 404 001 99A.

Spare Bracket for 2 $\frac{1}{4}$ " Tube, Cat. No. 404 002 99A.

Spare Liner with Lip and Tube, See Fig. 483 DP, Specify Size, Page 192.

Fig. 404

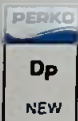

## FISHING ROD HOLDER FIG. 1104

### SIDE MOUNT

Black Plastic  
with Chrome Plated Brass Brackets.

#### ORDERING INFORMATION

I.D. Tube Inches	O.D. Tube Inches	Length Overall Inches	Width Bracket Inches	Display Pkg.-5 pkgs. 1 Pc. per pkg.	Std. Pkg.-5 pcs. OEM Pkg.-25 pcs.	Weight Pounds
1 $\frac{5}{8}$	2	9	3 $\frac{3}{4}$	1104 DP BLK	1104 000 BLK	$\frac{5}{8}$

Bolt Size #8 R.H.

Spare Bracket, Cat. No. 1107 000 CHR.

Fig. 1104



## FISHING ROD HOLDER FIG. 1118

### CLAMP ON

Chrome Plated Brass and Bronze with Soft Black Liner.

Clamp-On Feature Eliminates Drilling Rail and Simplifies Relocation.

Mounts on Vertical or Horizontal Rails.

Adjustable For Rails  $\frac{7}{8}$  to 1 Inch in Diameter  
and by Reducing Mounting Bolt Length,  $\frac{3}{4}$  Inch Diameter Rails.

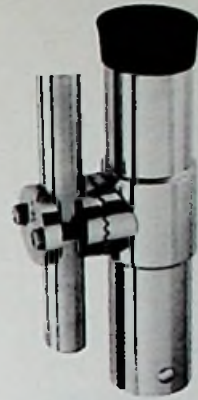

Fig. 1118

#### ORDERING INFORMATION

I.D. Tube Inches	O.D. Tube Inches	Length Overall Inches	Standard Pkg.-1 pc.	Weight Pounds
1 $\frac{5}{8}$	2	9	1118 000 CHR	2 $\frac{1}{4}$

Spare Face Plate with Bolts, Cat. No. 1118 000 99A.

Spare Intermediate Plate, Cat. No. 1118 000 99B.

Spare Liner with Lip and Tube, Cat. No. 483 DP1 BLK.

## FISHING ROD HOLDER FIG. 1215

### CLAMP ON

Chrome Plated Zinc with Stainless Steel Tube and Black Plastic Liner.

Clamp-On Feature Eliminates Drilling Rail and Simplifies Relocation.

Mounts on Vertical or Horizontal Rails.

Adjustable for Rails  $\frac{7}{8}$  to 1 Inch in Diameter  
and By Reducing Mounting Bolt Length,  $\frac{3}{4}$  Inch Diameter Rails.

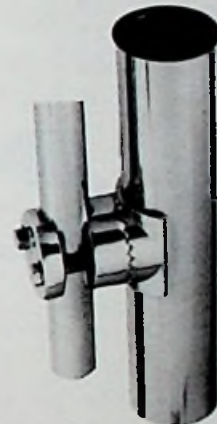

Fig. 1215

#### ORDERING INFORMATION

I.D. Tube Inches	O.D. Tube Inches	Length Overall Inches	Display Pkg.-5 pkgs. 1 Pc. per pkg.	Standard Pkg.-5 pcs.	Weight Pounds
1 $\frac{5}{8}$	2	9	1215 DP CHR	1215 000 CHR	2

Spare Face Plate with Bolts, Cat. No. 1215 000 99A.

Spare Intermediate Plate, Cat. No. 1215 000 99B.



## FISHING ROD HOLDER FIG. 475

### ADJUSTABLE

Chrome Plated Brass and Manganese Bronze with Soft Black Liner.

May be Adjusted Quickly to Desired Angle From Vertical  
to Horizontal and Locked in Place With a Large Thumb Bolt.

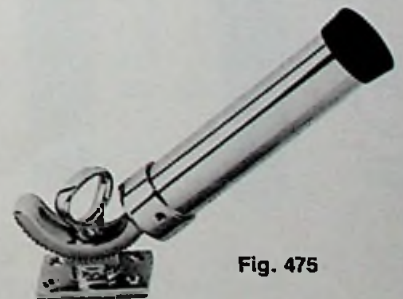

Fig. 475

#### ORDERING INFORMATION

I.D. Tube Inches	O.D. Tube Inches	Length Overall Inches	Dimensions Base Inches	Display Pkg.-1 card 1 Pc. per card	Standard Pkg.-1 pc.	Weight Pounds
1 $\frac{5}{8}$	2	9 $\frac{1}{2}$	3 $\frac{5}{8}$ x 2 $\frac{1}{4}$	475 DP CHR	475 000 CHR	3 $\frac{1}{4}$

Bolt Size  $\frac{1}{4}$ ".

Spare Saddle, Cat. No. 475 C00 99B.

Spare Thumb Bolt, Cat. No. 475 C00 99C.

Spare Base, Cat. No. 475 C00 99D.

Spare Liner with Lip and Tube, Cat. No. 483 DP1 BLK.



## FISHING ROD HOLDER FIG. 449

### REMOVABLE

Chrome Plated Brass and Manganese Bronze  
with Soft Black Liner.

Designed for Vertical Mounting, This Holder is Easily Removed  
When Not in Use, Leaving No Projecting Hardware.

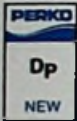

Fig. 449

I.D. Tube Inches		O.D. Tube Inches		Dimensions Bracket Inches	Display Pkg.-1 card 1 Pc. per card	Standard Pkg.-1 pc.	Weight Pounds
1 5/8		2		4 x 3 3/4	449 DP CHR	449 000 CHR	2 1/4

Screw Size #10.

Spare Holder Only, Cat. No. 449 000 99A.  
Spare Bracket Only, Cat. No. 449 000 99B.  
Spare Liner with Lip and Tube, Cat. No. 483 DP1 BLK.



## CAP AND GASKET KITS FIGS. 480 & 481

Soft Black Flange Gasket with Integral Flip-up Cap and Soft Black Lip.  
Replacement or Upgrade for Older Holders.



Fig. 480

### ORDERING INFORMATION

To Fit Cat. No.	Display Pkg.-5 bags 1 Kit per bag	Weight Ounces
448 001 CHR	480 DP BLK	3
1205 000 CHR	480 DP BLK	3
452 000 STS	481 DP BLK	3

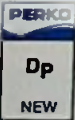

## LINERS, LIPS AND TUBES FIGS. 482 & 483

### FOR FISHING ROD HOLDERS

Except Figs. 1104 and 1215



Fig. 482



Fig. 483

### ORDERING INFORMATION

I.D. Inches	For Flush Mount Complete Display Pkg.-5 bags 1 Set per bag	For All Others Complete Display Pkg.-5 bags 1 Set per bag	Spare Lip Only For Fig. 482 Display Pkg.-5 bags 1 Pc. per bag	Spare Lip Only For Fig. 483 Display Pkg.-5 bags 1 Pc. per bag	Spare Tube Only For Fig. 482 Std. Pkg.-1 pc.	Spare Tube Only For Fig. 483 Std. Pkg.-1 pc.
1 5/8	482 DP1 BLK	483 DP1 BLK	482 DP1 99A	483 DP1 99A	482 001 99B	483 001 99B
1 7/8	482 DP2 BLK	483 DP2 BLK	482 DP2 99A	483 DP2 99A	482 002 99B	483 002 99B

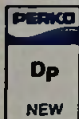

## NUMERICAL INDEX

Fig. No.	Page No.	Fig. No.	Page No.	Fig. No.	Page No.	Fig. No.	Page No.	Fig. No.	Page No.
02	34	121	85	220	132	309A	45	408	183
4D	44	122	158	221	132	309B	18	409	182 & 183
4F	31	123	92	222	26	310	78	410	182 to 185
5D	44	124	111	230	36	311	105	411	146
5F	31	125	13 & 16	231	36	312	69	412	45
06	34	126	99	233	144	313	51	413	133
7D	44	127	92	234	20	315	88	414	110
7F	31	128	69	235	20	318	71	415	182, 184 & 185
17	33	129	47	236	127	320	112	420	92
18	33	130	3	237	127	322	103	423	182
19	33	131	31, 33 & 44	246	36	323	102	424	84
20	33	132	71	248	38	324	110	425	182
21	47	133	46	249	43 & 48	325	131	429	128
23	47	134	32 & 43	250	28	328	105	430	128
24	36	135	6 & 8	255	80	329	28	431	124
52	36	136	2	256	38 & 48	330	90	433	49 to 51
60	179	137	72	257	70 & 71	334	91	434	128
62	179	138	36	258	152	335	91	435	49 & 50
63	107	139	4	259	38 & 48	336	91	440	49
65	108	140	72	260	38	337	37	441	94
66	108	141	69	261	38 & 48	337	86	444	186
69	37	142	103	263	111	339	88	445	184
70	37 & 86	144	92	265	73	340	37	448	189
71	37	148	146	266	111	340	86	449	192
72	37	149	152	268	38	342	48	450	74
74	38	150	92	269	38 & 48	344	129	451	186
75	103 & 104	152	152	271	157	346	71	452	189
76	107	153	92	272	157	347	48	454	46
82	147	155	149	276	36 & 45	348	104	455	19
86	108	158	93	278	38	349	94	460	187
91	30	159	93	280	73	350	104	465	92
92	30	160	122	281	38	351	129	468	187
97	33	162	94	283	38	356	102	469	187
98	30	163	85	284	38	358	137	470	185
99	30	164	85	285	102	360	147	471	187
102	33	165	85	286	36	362	18	474	186
105	79	166	92	287	36	363	111	475	191
106	38	168	69	290	36	365	102	476	187
107	6	171	92	291	34	366	79	477	20 & 135
108	18 & 29	172	92	292	34	371	18	478	186
109	29	179	93	293	34	373	48	479	186
110	29	180	134	294	44	374	37 & 48	480	192
111	29	185	134	296	38	375	37	481	192
112A	45	196	85	299	110	380	133	482	192
112B	18	197	158	300	70	381	79	483	192
113	92	200	25 to 28	301	105	395	180	492	135
116	179	201	38	303	48	400	183	493	95
117	179	212	152	305	51	401	182 to 185	495	132
118	179	217	74	306	80	403	45	497	134
119	123	218	132	307	114	404	190	498	134
120	22 to 24 & 158	219	132	308	70	406	184 & 185	499	101

## NUMERICAL INDEX

Fig. No.	Page No.	Fig. No.	Page No.	Fig. No.	Page No.	Fig. No.	Page No.	Fig. No.	Page No.
500	95	613	141	811	62	896	179	962	169
501	129	614	140	815	114	898	179	962	170
502	135	626	82	816	62	901	179	962	171
503	89	627	83	817	62	902	68	962	172
504	101	629	82	819	112	903	126	963	6
505	88	634	136	820	62	904	3	964	11
506	88	647	83	825	107	907	179	967	150
507	97	659	141	826	100	908	68	968	168
508	97	669	146	828	145	909	68	969	67
509	89	671	113	829	145	912	167 to 172	970	5
510	87	672	112	830	145	913	169	972	3
513	96 to 98	673	113	831	145	915	6	973	171
514	71 & 81	688	81	832	145	918	169	975	178
515	89	694	82	833	145	919	169	976	164, 169 & 170
516	81	697	150	834	106	920	167 to 171	977	166 to 168
517	81	701	80	835	106	921	165	978	164
518	88 & 89	703	80	836	62	922	165	980	165
519	81	704	109	837	62 & 66	924	159	982	47
520	98	705	109	839	62 & 66	925	173	983	166
521	98	708	94	840	66	926	173	984	166 to 170
522	81	709	109	841	174	927	171	985	47
524	97	714	111	842	142	928	170	986	166
526	101	719	177	844	62 & 66	929	168	987	156
528	96	720	84	845	62 & 66	930	170	988	156
530	117	721	109	846	62 & 66	931	165	991	167
533	142	722	109	847	66	932	165	992	167
534	50	732	138	848	66	934	177	994	179
535	50	734	112	851	51 & 67	935	177	995	167 & 168
537	100	737	111	852	51 & 67	937	177	996	179
538	49	741	125	859	66	938	172	997	179
539	101	742	111	860	62 & 66	939	8	998	159
544	117	750	125	863	128	940	8	999	156
545	117	752	124	869	179	941	157	1002	153
546	122	753	71	870	87	942	157	1003	153
550	90	754	138	872	64, 65 & 67	944	177	1004	154
554	163	757	125	873	64, 65 & 67	945	8	1016	176
555	71	759	126	874	67	946	8	1017	135
559	163	762	149	875	67	947	160	1021	172
561	89	769	150	876	67	948	164	1023	35
562	139	770	150	878	67	949	154	1024	165
565	136	773	155	879	67	951	155	1025	165
566	115	775	131	880	64, 65 & 67	952	155	1026	35
567	172	776	175	881	139	953	169	1027	35
572	116	786	83	883	54 & 55	954	176	1028	170
573	120	797	149	884	56 & 57	955	6	1029	168
574	162	805	106	885	58 & 59	956	161	1030	170
575	174	806	62 & 66	886	60 & 61	957	159	1040	73
578	180	807	62 & 66	889	68	958	176	1041	142
608	124	808	156	890	68	959	159	1042	142
610	178	809	62 & 66	891	68	959	161	1043	129
612	141	810	62 & 66	892	68	960	171	1044	72



## NUMERICAL INDEX

Fig. No.	Page No.	Fig. No.	Page No.	Fig. No.	Page No.	Fig. No.	Page No.	Fig. No.	Page No.
1045	5 & 8	1153	42	1221	175	1302	132	1934	68
1046	14	1154	42	1222	130	1303	74	1935	68
1047	5 & 14	1155	144	1223	122	1305	118	1936	68
1050	129	1156	35	1224	134	1306	120	8501	76
1051	173	1158	4, 11 to 13	1226	137	1307	123	8502	76
1053	161	1161	2	1227	143	1308	123	8503	76
1055	114	1164	41	1230	123	1309	140	8504	76
1056	172	1165	41	1231	131	1310	2	8505	78
1057	125	1166	41	1232	174	1311	17	8506	78
1059	16, 17 & 35	1167	41	1235	127	1312	87	9601	77
1060	17 & 35	1168	41	1237	124	1313	99	9602	77
1065	163	1169	40	1238	90	1314	186	9603	77
1068	168	1170	40	1239	167	1315	119	9604	77
1087	69	1172	40	1240	167	1316	121		
1088	113	1173	40	1242	139	1320	186		
1090	69	1174	40	1243	138	1321	186		
1098	188	1175	114	1244	161	1324	99		
1100	190	1177	162	1246	140	1325	129		
1101	164	1178	11	1247	100	1329	99		
1102	164	1179	148	1248	100	1330	16		
1103	174	1180	148	1249	180	1331	11		
1104	190	1181	12	1250	124	1332	9		
1105	40 to 42	1183	12	1251	115	1336	130		
1106	178	1184	12	1252	115	1346	130		
1107	190	1185	144	1253	70	1399	99		
1108	151	1186	144	1254	72	1400	20 & 35		
1109	36	1187	144	1255	136	1405	118		
1110	176	1188	116	1256	137	1406	120		
1111	46	1189	84	1261	137	1410	2		
1112	151	1190	84	1262	143	1411	17		
1113	151	1191	84	1264	6	1413	99		
1114	188	1192	13	1267	143	1415	119		
1115	188	1194	160	1269	97	1416	121		
1116	148	1196	12	1270	98	1430	15		
1117	148	1197	12	1271	90	1600	20 & 35		
1118	191	1198	160	1279	169	1601	7		
1119	40 to 42	1199	162	1280	169	1602	7		
1123	13	1201	4	1286	175	1603	4		
1124	13	1205	189	1287	162	1611	17		
1125	13	1209	16	1288	175	1612	5		
1127	32 & 43	1210	116	1289	141	1630	16		
1128	32 & 43	1211	5	1290	147	1631	15		
1129	32, 43 & 46	1212	5	1291	147	1640	14		
1130	32 & 43	1213	156	1292	147	1660	14		
1133	41	1214	156	1293	154	1901	64 & 65		
1134	19	1215	191	1295	74	1902	64 & 65		
1137	19	1216	163	1296	5	1903	64 & 65		
1143	40 & 41	1217	163	1297	133	1930	64 & 65		
1150	42	1218	3	1298	133	1931	64 & 65		
1151	42	1219	124	1299	140	1932	68		
1152	42	1220	175	1301	19	1933	68		

## ALPHABETICAL INDEX

A	PAGE
Adapter —	
Pipe to Hose.....	107
Adjusters —	
Hatch.....	149
Windshield .....	147 & 148
All-Round Lights .....	12 to 20, 26,27,28,29, 32, 34, 35, 40 to 43, 45 to 47
Anchor Chocks.....	126
Anchor Lights.....	12 to 20, 26,27,28, 29, 32, 34, 35, 40 to 43, 45 to 47
Assemblies, Control.....	65 & 67
Axe Brackets.....	131
B	
Bass Boat Lights.....	5
Bells —	
Fog.....	92 & 93
Smoke.....	69
Berth Lights.....	69 & 74
Bits.....	124
Boarding Steps.....	129
Bolts —	
Barrel.....	160 & 161
Cupboard.....	164
Ship.....	161
Book, Log.....	94
Bow —	
& Anchor Lights.....	12 & 13
Combination Lights.....	2 to 5, 22 to 26
Eyes.....	127
Boxes, Stuffing.....	112 & 113
Brackets —	
Axe.....	131
Table.....	146
Breakdown Lights.....	40 to 45
Bulbs, Electric.....	37, 48, 66 & 88
Butt Hinges.....	153 to 159
Buttons —	
Door.....	163
Horn Push.....	80
C	
Cabin —	
Door Hooks.....	161 & 162
Lamps, Oil.....	69
Cabinet Hinges.....	156 to 159
Cable —	
Outlet.....	84
Straps.....	85
Caps, Gas Tank.....	99
Catches, Door .....	163 & 164
Caulking Iron .....	114
Certification of Lights .....	1 & 39
Chain —	
Deck Pipe .....	125

C - Contd.	PAGE
Portlight .....	94
Chocks .....	122 & 123
Chocks, Anchor .....	126
Clam Shell Ventilators .....	88
Clamps —	
Hatch Hold-Down .....	151
Spring .....	20 & 135
Rope .....	137
Cleats .....	115 to 117 & 128
Clips —	
Line Support .....	85
Trolling .....	187
Coat & Hat Hooks .....	178
Cockpit Scupper .....	102 & 103
Collar, Rudder .....	114
Combination —	
Bow & Anchor	
Lights .....	12 & 13
Side Lights .....	2 to 5, 22 to 26
Connections —	
Electric .....	84
Thru-Hull .....	102 to 105
Watertight, Deck .....	84
Connectors, Electric .....	84
Connectors, Garden Hose .....	101
Continuous Hinge .....	152
Control —	
Assemblies .....	65 & 67
Convertible Boat Top	
Fittings .....	180
Courtesy Lights .....	72
Cowl Ventilators .....	87
Cupboard —	
Bolts .....	164
Catches .....	164
Turns .....	164
Curtain Fasteners .....	179
D	
Deck —	
Connection, Watertight .....	84
Lights .....	10 & 73
Pipes, Rope & Chain .....	124 & 125
Plate Keys .....	100
Plates .....	96 to 99 & 101
Dock Line Springs .....	126
Dome Lights.....	70 & 71.
Door —	
Buttons .....	163
Catches .....	163 & 164
Fasteners .....	150 & 151
Hinges .....	152 to 159
Holders .....	163
Hooks .....	161 & 162
Stops .....	162

## ALPHABETICAL INDEX

D - Contd.	PAGE
Drain Plugs .....	110 & 111
Drawer —	
Knobs .....	173
Pulls .....	170 to 172
Dredging Light .....	46
Durade Ventilator .....	87

### E

Elbow Catches .....	172
Electric —	
Bulbs .....	37, 48, 66 & 88
Cabin Fixtures .....	69 to 74
Connections .....	84
Lamps .....	69 to 74
Sockets .....	34, 36, 48, 65 to 68
Switches .....	75 to 81
European Representative .....	IX
Eyes —	
Bow .....	127
Flange .....	127 & 128
Halyard .....	20
Lashing .....	127 & 128
Lifting .....	128
Transom .....	127

### F

Fasteners —	
Curtain .....	179
Door .....	150 & 151
Hatch .....	150 & 151
Table Leg .....	177
Fender —	
Hooks .....	140
Locks .....	140
Filler, Tank .....	96 to 99
Filters, Fuel .....	110
Filters, Water .....	95
Fishing —	
Pole Holders .....	189 to 192
Fittings —	
For Boat Top .....	179 & 180
For Rails .....	133 & 134
Waste .....	97
Fixtures, Light —	
Bulkhead, Oil .....	69
Bulkhead, Electric .....	74
Electric Cabin .....	69 to 74
Vapor Proof .....	69
Flag Pole —	
Sockets .....	132
Flag Staffs .....	132
Flange Eyes .....	127 & 128
Flush —	
Hatch Lifting Handles .....	175
Hatch Lifting Rings .....	173 & 174

### F- Contd.

F- Contd.	PAGE
Pulls .....	165, 167, 169, 173 to 176
Ring Catch .....	173
Fog Horn .....	94
Fuel —	
Filter .....	110
Separator .....	110
Strainer .....	110
Tank Filler .....	96, 98 & 99
Fuse —	
Holder .....	81 to 83
Panels .....	81 to 83

### G

Gas —	
Strainer .....	110
Tank Caps .....	96, 98 & 99
Tank Filler .....	96, 98 & 99
Tank Vents .....	88 & 89
Globes .....	38, 48, 69 to 71
Grab Rail Posts .....	133 & 134
Grab Rails .....	133 & 134
Guides, Tiller Rope .....	137 & 138
Guides, Pole Line .....	187

### H

Halyard Eyes .....	20
Halyard Mount Lights .....	27
Handles —	
Flush Lifting .....	175
Sliding Window .....	176
Utility .....	130 & 131
Hasps .....	159 & 160
Hatch —	
Adjusters .....	149
Fasteners .....	149 & 150
Hinges .....	152 to 158
Hold-Down Clamps .....	151
Lifting Handles .....	130, 131 & 175
Lifting Rings .....	173 to 175
Support Braces .....	149
Hawse Hole Plate .....	124
Heights, Vertical Light .....	21
Hinges —	
Butt .....	153 to 159
Butterfly .....	159
Cabinet .....	152 to 157 & 159
Continuous .....	152
Cuddy Door .....	153 to 159
Hatch .....	152 to 159
Hatch Support .....	149
Non-Mortised .....	159
Piano .....	152
Pull Apart .....	152
Rail .....	134
Semi-Concealed .....	157

## ALPHABETICAL INDEX

H - Contd.	PAGE
Shortside .....	156 to 158
Strap .....	158
"T" .....	158
Holders —	
Boat Hook .....	135
Door .....	162 & 163
Fishing Pole .....	189 to 192
Ring Buoy .....	135
Outrigger Pole .....	182 to 186
Hooks —	
Cabin Door .....	161 & 162
Coat & Hat .....	174
Fender .....	140
Lashing .....	178
Ski Towing .....	128
Snap .....	140 to 142
Utility .....	140, 174 & 176
Wardrobe .....	174
Horn Push Button .....	80 & 81
Horn, Fog .....	94
Horns, For Rowlocks .....	143 & 145
Hull Connections .....	101 to 105

### I

Information —	
Certification of Navigation Lights .....	1 & 39
Electrical Standards .....	75
Light, Vertical Heights .....	21
Lock Bevels .....	166
Outrigger Pole Usage .....	181
PERKO, Story of .....	III & IV
Representatives .....	X & XI
Searchlight Bulb Data .....	53
Sales Policy & Terms .....	V
Warranty .....	V & XII
Inlet —	
Fittings for Fresh Water .....	101
Strainer .....	108
Iron, Caulking .....	114

### K

Keys, Deck Plate .....	100
Knobs, Drawer .....	173

### L

Ladder Locks .....	146
Lamps —	
Cabin .....	69 to 74
Cabin, Oil .....	69
Wall .....	69 & 74
Lashing Eyes .....	127 & 128
Lashing Hooks .....	178
Latches —	
Door .....	164 to 173
Flush .....	165 & 169

L - Contd.	PAGE
Mortise Latch Sets .....	167, 171 & 172
Rim Latch Sets .....	164, 166 to 170
Wood Rail .....	134
Leathers, Oar .....	144
Lenses .....	38, 48, 69 to 71
Lifting Eyes .....	127 & 128
Light Chart, Vertical Heights .....	21
Lights —	
All-Round .....	12 to 20, 26, 27, 28, 29, 32, 34, 35, 40 to 43, 45 to 47
Anchor .....	12 to 20, 26, 27, 28, 29, 32, 34, 35, 40 to 43, 45 to 47
Bass Boat .....	5
Berth .....	69 & 74
Bi-Color .....	2 to 6, 22 to 26
Breakdown .....	40 to 45
Combination .....	2 to 5, 12, 13 & 22 to 28
Courtesy .....	72
Deck .....	10, 22 & 73
Dredging Light .....	46
Dome .....	70 & 71
For Windshield .....	12 & 13
Mounting .....	4, 10 to 12, 19, 22 to 24, 26, 28, 29, 32, 40 to 45
Mast .....	10 to 13, 22 to 26, 28 to 33, 40 to 45 & 47
Masthead .....	28 to 33, 40 to 45 & 47
Meal & Absent .....	28
Not Under-Command .....	40 to 45
Pole .....	5, 8, 12 to 17 & 19
Range .....	40 to 45
Searchlights .....	49 to 64
Side .....	6 & 7, 22 to 26, 29 to 33, 40 to 45 & 47
Signal .....	29 to 34, 40 to 45 & 47
Spreader .....	73
Stern .....	8, 9, 22 to 26, 29 to 33, 40 to 45 & 47
Towing .....	25, 26, 29 to 33, 40 to 45 & 47
Utility .....	72
Vapor-Proof .....	69
Line Support Clips .....	85
Locks —	
Doors .....	165 to 171
Fender .....	140
Flush .....	165
Ladder .....	146
Mortise .....	171
Rim .....	169
Window .....	173
Log Book .....	94
Log, Shaft .....	113
Locker Ventilators .....	90
Louver Ventilators .....	91

## ALPHABETICAL INDEX

M	PAGE
Mast Lights ..	4, 10 to 12, 19, 22 to 24, 26, 28, 29, 32, 40 to 45
Masthead Lights ..	10 to 13, 22 to 26, 28 to 33, 40 to 45 & 47
Meal and Absent Light ..	28
Mooring Bitts ..	124

N	PAGE
Name Plates, Switch ..	81
Navigation Lights --	
For Vessels:	
Under 20 Meters (65.6 ft.) In Length .....	1 to 34
Over 20 Meters (65.6 ft) In Length .....	39 to 47

O	PAGE
Oar —	
Leather and Buttons ..	144
Locks ..	143 to 145
Outboard Motor Transom	
Plates ..	134
Outlets —	
Cable ..	84
Water ..	101
Outrigger —	
Holders ..	181 to 186
Kit ..	187
Pole Line Guides ..	187
Poles ..	187 & 188
Spreaders ..	188
Trolling Pins ..	187

P	PAGE
Paint Scraper ..	114
Palm, Sewing ..	146
Panels —	
Fuse ..	81 to 83
Switch ..	81
Piano Hinge ..	152
Pin, Trolling ..	187
Pipes, Rope Deck ..	124 & 125
Plates —	
Deck ..	96 to 101
Hawse Hole ..	124
Step ..	129
Transom ..	134
Plugs, Drain ..	110 & 111
Pole Holders —	
Fishing ..	189 to 192
Outrigger ..	181 to 186
Pole Light —	
Replacement Bases ..	35
Replacement Poles ..	35
Vertical Height Chart ..	21
Pole Lights ..	5, 8, 12 to 17 & 19
Pole Sockets, Flag ..	132

P - Contd.	PAGE
Poles —	
Flag ..	132
Outrigger ..	187 & 188
Posts —	
Grab Rail ..	133
Stanchion ..	133
Pulleys ..	136
Pulls —	
Drawer ..	173 to 176
Flush ..	165, 167, 169, 173 to 176
Pump Strainers ..	109

R	PAGE
Rail —	
Fittings ..	133
Hinges And Latches ..	134
Tubing ..	134
Rails, Grab ..	133 & 134
Range Lights ..	40 to 45
Representatives ..	X & XI
Rim Locks ..	167 & 169
Rim Latches ..	164, 166 to 170
Ring —	
Buoy Holders ..	135
Catches, Flush ..	169 & 173
Pulls ..	173 to 175
Rings, Hatch Lifting ..	174 & 175
Roller Tip Line Guide ..	187
Rope —	
Clamps ..	137
Guides ..	137 & 138
Pulleys ..	136
Rope Tighteners ..	138
Rowlocks ..	143 to 145
Rudder —	
Collar ..	114
Stuffing Boxes ..	112 & 114

S	PAGE
Safety Cable ..	100
Scraper ..	114
Scuppers —	
Cockpit ..	100 & 101
Thru-Hull ..	102
Valve Assembly ..	102
Seacocks ..	106
Searchlight —	
Bulbs ..	53, 62 & 66
Control Assemblies ..	65 & 67
Spare Parts ..	68
Searchlights ..	49 to 68
Separator, Fuel ..	110
Shaft Log ..	113
Shield, For Pole or Mast Lights ..	13

## ALPHABETICAL INDEX

S - Contd.	PAGE
Side Lights .....	6 & 7, 22 to 26, 29 to 33, 40 to 45 & 47
Signal Lights, Portable or Fixed .....	29 to 34, 40 to 45 & 47
Ski Towing Hook .....	128
Smoke Bell & Arm .....	69
Snap Hooks .....	140 to 142
Sockets —	
Boat Cover .....	180
Electric .....	34, 36, 48, 65 to 68
Fishing Rod .....	189 to 192
Flag Staff .....	132
Rowlock .....	144 & 145
Searchlight .....	65, 66 & 67
Spreaders For Outrigger Poles .....	188
Spreader Lights .....	73
Spring Clamps .....	135
Springs For Dock Line .....	126
Spring, Tiller Rope .....	138
Staffs, Flag .....	132
Steps —	
Boarding .....	129
Folding .....	129
Step Plates .....	129
Stern —	
Lights .....	8, 9, 22 to 26, 29 to 33 40 to 45 & 47
Pole Lights .....	8, 14 to 17
Stops —	
Door .....	162
Window .....	177
Strainers —	
Fuel .....	110
Gasoline .....	110
Thru-Hull .....	108
Inlet .....	95 & 108
Pump .....	109
Water .....	95
Strap Hinges .....	158
Straps, Cable .....	85
Strut .....	114
Stuffing Boxes .....	112 & 113
Switch —	
Name Plates .....	81
Panels .....	81
Switches —	
Battery .....	76 to 78
Electric .....	76 to 81
Master .....	77
Panel .....	81
Swivel —	
Eye Pulleys .....	136
Eye Snaps .....	141 & 142

### T

T Hinges .....	158
----------------	-----

T - Contd.	PAGE
Table Brackets .....	146
Table Leg Fasteners .....	177
Terminal Blocks .....	83
Thru Hull Connections .....	102 to 105
Tiller —	
Rope Clamps .....	137
Rope Guides .....	137 & 13
Rope Pulleys .....	136
Rope Tighteners .....	138
Towing Hooks .....	128
Towing Lights .....	25, 26, 29 to 33, 40 to 45 & 47
Transom —	
Eyes .....	127
Plates .....	134
Stern Light .....	8
Ventilators .....	90
Trim, Hatch .....	152
Trolling Pin .....	187
Tubing, Grab Rail .....	134
Tri-Color Lights .....	4, 26 & 28
Turns, Cupboard .....	164 & 166

### U

Universal Replacement Pole Light .....	35
Universal Strut .....	114
Utility Hooks .....	140, 174 & 180
Utility Lights .....	72

### V

Vapor Proof Fixtures .....	69
Ventilator —	
Cowl .....	87
Durade .....	87
Gas Tank .....	88 & 89
Locker .....	88
Louver .....	89
Clam Shell Type .....	86
Transom .....	88

### W

Wardrobe Hooks .....	178
Warranty Information .....	V & XII
Waste Fitting .....	97
Water Strainers .....	95
Whistle .....	94
Window —	
Anti-Rattler .....	177
Handle, Sliding .....	176
Lock .....	177
Stop .....	177
Windshield —	
Adjusters .....	147 & 148
Keeper & Plate .....	149 & 150
Pole Lights for .....	12 & 13
Wiper .....	142

# PERKO®

WE MAKE IT RIGHT. RIGHT HERE

Street Address  
16490 Northwest 13th Avenue  
Miami, Florida 33169-5707

Mailing Address  
P.O. Box 64000D  
Miami, Florida 33164-0510

Telephone Number  
(305) 621-7525

Fax Number  
(305) 620-9978

**THE DIFFERENCE®  
IS DISTINCTIVE**

**WE ARE MEMBERS OF THE FOLLOWING  
MARINE ASSOCIATIONS**



NATIONAL MARINE  
MANUFACTURERS ASSOCIATION



AMERICAN BOAT AND YACHT COUNCIL, INC.  
CHARTER MEMBER



THE PROPELLER CLUB OF THE  
UNITED STATES



MARINE RETAILERS ASSOCIATION  
OF AMERICA

# PERKO®

WE MAKE IT RIGHT. RIGHT HERE.

