

The logo for PERKO is rendered in a bold, blue, three-dimensional font with a metallic sheen and a registered trademark symbol (®) to the upper right.

The Difference is Distinctive®

CATALOG NO. 280

1997 - 1998



Manufacturer of Marine Lights, Hardware and Accessories
We Make It Right. Right Here!!



Started by Frederick Perkins in the late 1880's and later moved into a small plant in New York City. It's now four generations later, PERKO, Inc. is still a private family owned and operated corporation housed in a modern facility of over 425,000 square feet in Miami, Florida. This close control continues to allow us to respond quickly to the needs of our customers and changing market demands.

Our philosophy has always emphasized a long term commitment to quality leadership in the marine industry. Our employees are an integral part of our business family, dedicated to manufacturing the highest quality marine products.

PERKO is a truly vertically integrated manufacturer, producing most components from raw materials. This has enabled us to meet our objective of providing our customers with the highest quality marine lights, hardware and accessories at competitive market prices.

PERKO®

WE MAKE IT RIGHT, RIGHT HERE. . .

CATALOG NO. 280 1997 - 1998

STREET ADDRESS

16490 NORTHWEST 13TH AVENUE
MIAMI, FLORIDA 33169-5707

MAILING ADDRESS

P.O. Box 64000D
MIAMI, FLORIDA 33164-0510

TELEPHONE NUMBER

(305) 621-7525

FAX NUMBER

(305) 620-9978

© Perko, Inc. 1996
All Rights Reserved

Portions of this Catalog
Previously Copyrighted in
1936 - 1995 Inclusive



THE DIFFERENCE IS DISTINCTIVE®

MANUFACTURER OF
SHIP AND BOAT EQUIPMENT

NAVIGATION LIGHTS FOR
VESSELS UNDER 20 METERS
1 - 43

NAVIGATION LIGHTS FOR
VESSELS OVER 20 METERS
44 - 52

SEARCHLIGHTS
53 - 68

ELECTRICAL SWITCHES,
LIGHTING FIXTURES,
BULBS
69 - 87

COMPARTMENT VENTILATORS,
FUEL VENTS & BELLS
88 - 95

PIPE & HOSE DECK PLATES,
UNDERWATER FITTINGS,
STRAINERS & FILTERS
96 - 116

DECK HARDWARE, CLEATS,
CHOCKS, BITTS, BOW EYES,
ROWLOCKS, WINDSHIELD &
HATCH ADJUSTERS
117 - 146

CABINET & DOOR
HARDWARE,
LOCKS & LATCHES,
HINGES, HOOKS ETC.
147 - 182

FISHING EQUIPMENT
183 - 192

GENERAL INFORMATION

SALES POLICY

PERKO Products are sold through our established Distributors. We do not sell direct to the public or organizations. Therefore, possession of this catalog does not infer an offer to sell. Please contact your local marine supplier.

PRICES AND TERMS

Our costs are subject to change due to causes beyond our control. Therefore, our price list is only intended for the guidance of our customers and does not necessarily establish current prices. *A Repackaging Service Charge of \$5.00 net will apply to all broken packages.* All prices are subject to change without notice. Terms are 1% 10 days, net 30 days.

Orders from firms having no satisfactory history or credit rating with us must be prepaid. C.O.D. shipments will be made if a 25% deposit is sent with order. Cash discounts do not apply to C.O.D. shipments.

ONE YEAR LIMITED WARRANTY

PERKO, INC. (PERKO) warrants to the original consumer-purchaser that PERKO'S consumer products will be free from defective materials or workmanship, under normal use and service, for a period of one (1) year from the original purchase date.

All implied warranties, including merchantability, are also limited in duration to the one year period from the original purchase date. PERKO shall not be liable for loss of use of any of its consumer products, nor shall PERKO be liable for other incidental or consequential costs, expenses, or damages incurred by the original consumer-purchaser or by any other person, firm or corporation.

Some states do not allow limitations on how long an implied warranty lasts, so the above limitation may or may not apply to you. Some states do not allow the exclusion or limitation of incidental or consequential damages, so the above limitation or exclusion may not apply to you.

This Warranty is void if the consumer product warranted has been damaged by accident or unreasonable use, neglect, improper service or other cause not arising out of defects in material or workmanship. Excluded from this Warranty are electric light bulbs (lamps), sealed beam units and fuses.

During the warranty period, your PERKO product will either be repaired

or it will be replaced with a like product (at PERKO'S option) without charge to the original consumer-purchaser, when returned prepaid and insured, with proof-of-purchase date to PERKO at our factory in Miami, FL. In the event of replacement, the replacement product will continue the warranty of the original product, or ninety (90) days, whichever is longer. **Important: For this Warranty to be effective PERKO must be supplied with Proof-Of-Purchase date of the product.**

PERKO does not authorize any person or company to create for it any other obligation or liability in connection with any of its products.

This warranty gives you specific legal rights, and you may also have other rights which vary from state to state.

PERKOPLATE/PERKO•KOTE LIMITED WARRANTY

PERKO, Inc. guarantees that all of its products finished with the PERKOPLATE chromium plating process will maintain their original luster and brightness, or those finished with the PERKO•KOTE powder coating process will remain corrosion-free for as long as the original consumer-purchaser owns them. During the Warranty period, PERKO, Inc. agrees to repair or replace, (at PERKO'S option) without cost to the original consumer-purchaser, any product upon which the PERKOPLATE chromium finish corrodes, becomes dull or otherwise does not maintain its original luster and brightness, or any product upon which the PERKO•KOTE finish corrodes. For this Warranty to be effective, the PERKO product must be returned prepaid and insured, with proof of purchase to PERKO, at our factory in Miami, Florida. **Important: For this Warranty to be effective PERKO must be supplied with Proof-Of-Purchase of the product.**

This Warranty is void if the PERKOPLATE or PERKO•KOTE finish has been damaged by accident, unreasonable use, neglect, improper service or other cause not arising out of defects in material or workmanship. **In no event shall PERKO, INC. be liable for loss of use of its consumer products nor for other incidental or consequential costs, expenses, or damages incurred by the individual.** Some states do not allow the exclusion or limitation of incidental or consequential damage, so the above limitation

may not apply to you. This Warranty gives you specific legal rights, and you may also have other rights which vary from state to state.

DESIGNS

For the purpose of constant improvement in our products, the designs and specifications are subject to change without notice.

RETURN GOODS

Products made to order are not returnable. Stock products in new, saleable condition are only returnable when permission has been granted by us, and are subject to handling and repackaging charges. Return shipping charges must be prepaid. Purchase date and invoice number are required when requesting an R.G.A. (Return Goods Authorization) number. Permission must be requested within 30 days after receipt of goods.

WEIGHTS

The weights given in this catalog are approximate, but should be sufficient for general purposes.

SHIPPING INSTRUCTIONS

Customers should send specific shipping instructions; otherwise, we will use our own judgement in selecting route.

SHIPMENTS

F.O.B. our plant, Miami, Florida, unless quoted otherwise. We are not responsible for damage, loss or delay after goods are delivered to carrier. When loss or delay occurs, we will gladly assist in tracing or expediting, but such assistance is no criterion of responsibility.

When there is **loss or apparent visible damage** to a shipment, when tendered for delivery, **do not** give the carrier a clear receipt. Note such damage on the carrier's delivery receipt and **have the driver sign the receipt.**

CONCEALED DAMAGE OR LOSS

1. Advise the delivering carrier in writing as soon as discovered or at least no more than 15 days after delivery, and request carrier to make an inspection.
2. **Retain** for the carrier's inspection, the container and all packaging that the damaged or lost material was packaged in.
3. **Shortages** - Must be reported to us within 15 days after receipt of goods.

OUR MODERN SELF-CONTAINED FACILITY



HOME OF PERKO, INC
MODERN 425,000 SQ.FT. FACILITY LOCATED ON 16 ACRES
IN MIAMI, FLORIDA

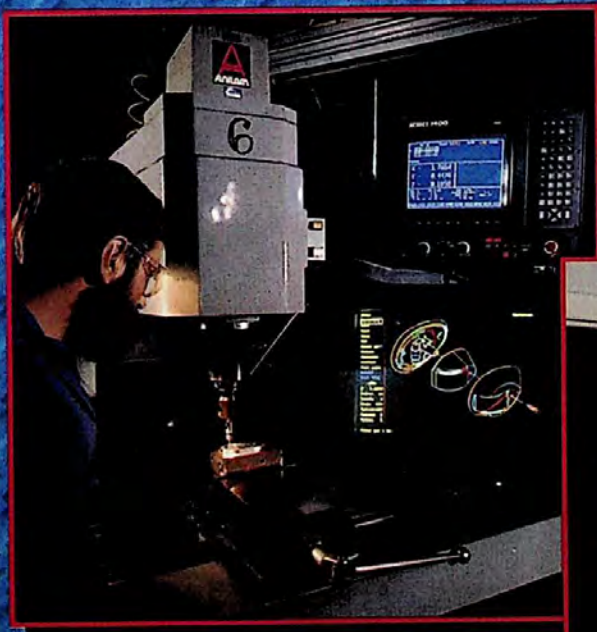

Above:
Computerized
Tool and Die
Department

Below:
Quality Control Lab Utilizing
Atomic Absorption
Spectrophotometry



OUR MODERN SELF-CONTAINED FACILITY

Top Left:
PERKOPLATE
Plating Department

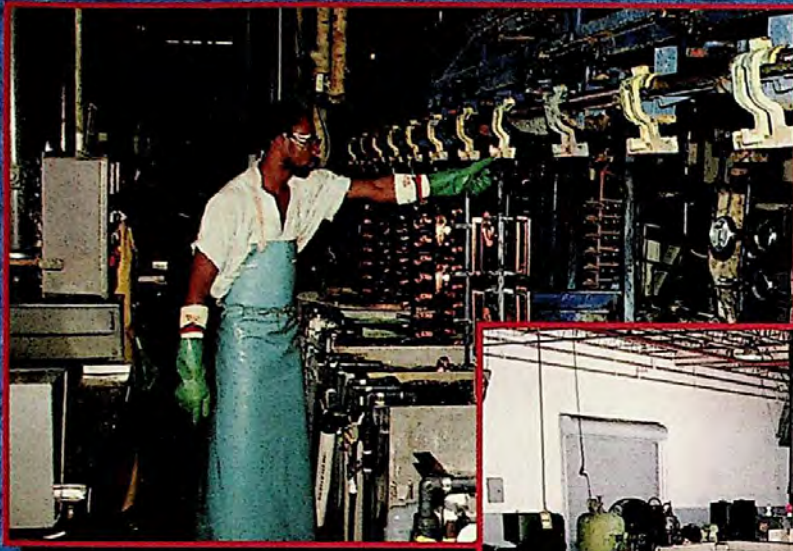

Below:
Die Cast
Department

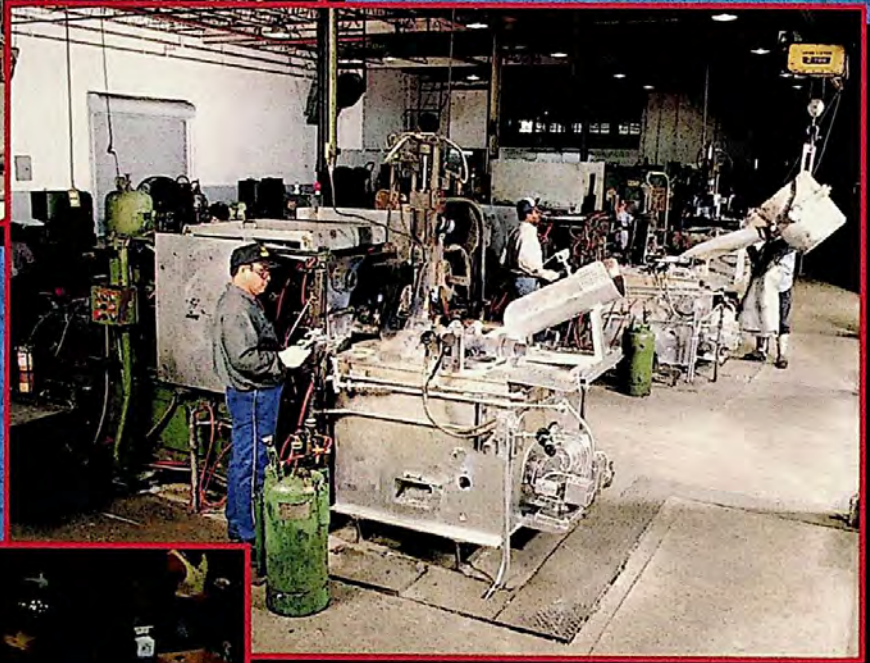

Below:
Searchlight
Department

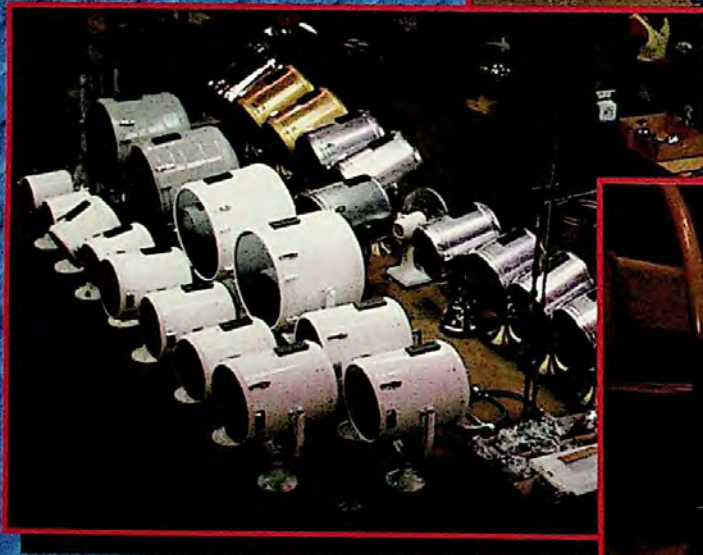

Bottom Right:
State-of-the-Art
Sand Cast Foundry



OUR MODERN SELF-CONTAINED FACILITY



Top Left:
*Plastic Injection Molding
Department*

Below:
*Battery Switch Assembly
Department*

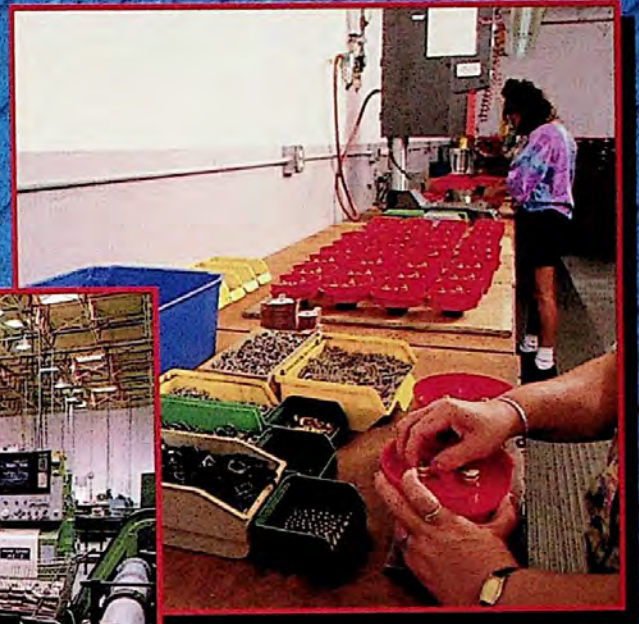

Right:
*Computerized
CNC Machining
Center*

Below:
*Automatic
Drilling Centers*



Below:
*Mechanical Power Press
Department*



Left:
*Ultrasonic Bonding of
Navigation Light Lenses*



REGIONAL SALES REPRESENTATIVES

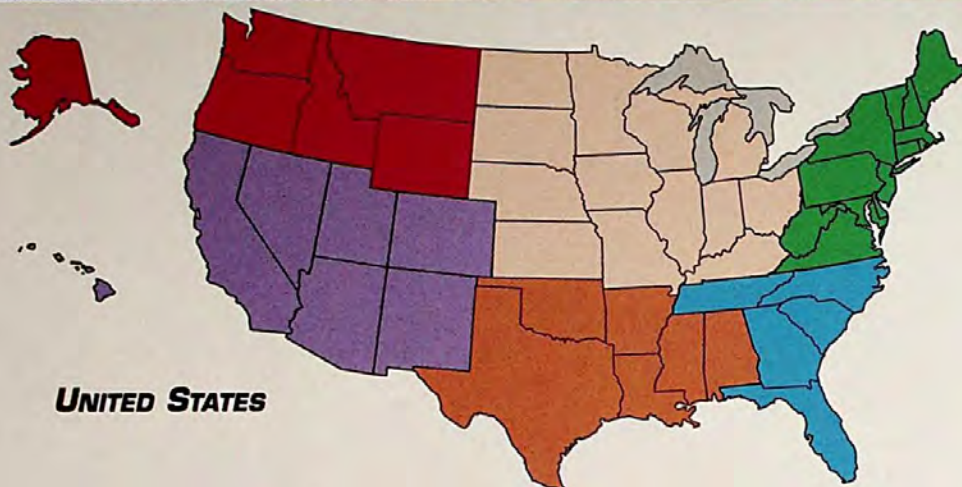

UNITED STATES

NORTHEAST

NEW HAMPSHIRE, VERMONT, CONNECTICUT, COASTAL MAINE

CGW Associates
354 Country Way/P.O. Box 414
Scituate, MA 02066
Phone 617-545-3790/Fax 617-545-0359
CHARLES W. O'CONNOR

NEW JERSEY, LONG ISLAND, NEW YORK, SO. MASS., RHODE ISLAND

CGW Associates
137 Brandt Island Road
Mattapoisett, MA 02739
Phone 508-758-2980/Fax 508-758-9705
WAYNE OLIVIERA

DELAWARE, E. PENNSYLVANIA MARYLAND, VIRGINIA

CGW Associates
1070 Ulmstead Circle, Arnold, MD 21012
Phone 410-757-9630/Fax 410-757-4365
KEVIN WILLIAMS

CENT. MAINE, E. CANADA, NO. MASS.

CGW Associates
4 King Street Ct., Rockport, MA. 01966
Phone 508-546-2085 Fax 508-546-5820
JACK HOGAN

N.Y. STATE, W. PENN., CENTRAL CANADA

CGW Associates
12 Cranswick Lane, Rochester, NY 14618
Phone 1-800-323-7816 Fax 716-385-6928
CHARLES KUIMJIAN

SOUTHEAST

NORTH & SOUTH CAROLINA

Henry S. Gartner & Associates, Inc.
235 Craven Street, New Bern, NC 28560
Phone 919-633-1210/Fax 919-633-1692
KEN WILLIAMS

GEORGIA, TENNESSEE

Henry S. Gartner & Associates, Inc.
Mac-Hugh & Associates
9411 Raven Hollow Rd, Brentwood, TN 37027
Phone 615-370-4132/Fax 615-373-3867
ROBERT TAYLOR

WESTERN & CENTRAL FLORIDA

Henry S. Gartner & Associates, Inc.
5125 Rolling Fairway Dr., Valrico, FL 32792
Phone 813-654-6561/Fax 813-654-7538
TRIPP HAMMACK

EASTERN & SOUTHERN FLORIDA

Henry S. Gartner & Associates, Inc.
2470 N.E. 22 Street/ P.O. Box 50227
Lighthouse Point, FL 33064
Phone 305-781-4303/Fax 305-781-4412
JACK BARNES & JAY BARNES

MIDWEST

MISSOURI, IOWA, NO. & SO. DAKOTA, NEBRASKA, KANSAS

Midwestern Sales Co., Inc.
3787 West 95th St., Overland Park, KS 66206
Phone 913-649-1270/Fax 913-649-2707
DENNIS WILLS & BILL LANNING

NO. ILLINOIS, MINNESOTA, WISCONSIN

Inland Marketing Associates, Inc.
601 Franklin Square/P.O. Box 680
Michigan City, IN 46360
Phone 219-879-2707/Fax 219-879-5224
EARL HENDERSON

ILLINOIS, E. WISCONSIN

Inland Marketing Associates, Inc.
730 N. Waukegan Road/P.O. Box 325
Deerfield, IL 60015
Phone 708-945-0545/Fax 708-945-0567
WM. D. GREENE

SO. ILLINOIS, SO. INDIANA, KENTUCKY, W. MICHIGAN

Inland Marketing Associates, Inc.
1071 Highland Ct./P.O. Box 414
Plymouth, IN 46563
Phone 219-936-6972/Fax 219-936-8248
ED KUYKENDALL

E. MICHIGAN, OHIO

Inland Marketing Associates, Inc.
500 S. Washington/Suite 1
Royal Oak, MI 48067
Phone 313-541-4404/Fax 313-541-4405
R. WILLIAM BURT

SOUTH CENTRAL

LOUISIANA, ALABAMA, MISSISSIPPI, SO. EAST ARKANSAS,

MAC-HUGH & Associates, Inc.
5540 Pepsi Street, Harahan, LA 70123
Phone 504-734-9411/Fax 504-734-5144
**KYLE McHUGH, BUZZ HUMPHREY,
DAVID HILDRETH,**

TEXAS, OKLAHOMA, ARKANSAS

MAC-HUGH & Associates, Inc.
10830 Tri-Cities Beach Road
Bay Town, TX 77520
Phone 713-383-2235
HUGH W. MULHOLLAND

SOUTH WEST

CALIFORNIA, NEVADA, UTAH, COLORADO, ARIZONA, NEW MEXICO HAWAII

Dugan & Associates, Inc.
3368 McGraw Road, Lafayette, CA 94549
Phone 510-284-4855/Fax 510-284-4856
WAYNE R. MOOERS

NORTH WEST

WASHINGTON, ALBERTA, BRITISH COLUMBIA, ALASKA, OREGON, IDAHO, MONTANA, WYOMING

Merifield Co., Inc.
927 N.W. 50th Street/P.O. Box 70626
Seattle, WA 98107
Phone 206-789-1800/Fax 206-783-7669
**TOM HARGER, IVAN CROSS &
CRAIG WESTLIN**

EUROPE

KEITH W. HEWITT
Penvic Marine Limited
32 Copperfields - Totton
Southampton Hampshire SO40FL
England
Phone (44) 0-1703-870341
Fax (44) 0-1703-663156

AFRICA, ASIA & PACIFIC RIM

Daniel J. Lyons
Greenwich Trading Company
69 Newton Turnpike
Westport, CT 06880-1807
Phone (203) 226-9697
Fax (203) 226-9935

JAPAN

Mrs. Masako Funabashi
ALTUS International LTD.
Gotanda K-1 Bldg. 5th Fl.
7-9, Higashi-Gotanda 4 Chome,
Shinagawa-Ku, Tokyo 141, Japan
Phone (03) 3444-2148
Fax (03) 3440-4166

For Information on other
Foreign Regions
Contact: Jose Martinez at Perko, Inc.

DISPLAY PACKAGING PROGRAM

SINCE THE PUBLICATION OF OUR LAST CATALOG, WE ARE CONTINUING TO INCREASE THE NUMBER OF PRODUCTS AVAILABLE IN "DISPLAY PACK" FORM. THESE ATTRACTIVE PACKAGES CONTINUE TO MAKE PERKO PRODUCTS EASIER TO SELL . . . AND EASIER FOR THE CUSTOMER TO BUY.

OUR COMMITMENT TO BETTER DEALER/DISTRIBUTOR SALES AND PROFITS IS BACKED BY OUR CONTINUING PROGRAM OF SERVICE AND SUPPORT. IT'S A PERKO PLUS!

AS YOU LOOK THROUGH THIS CATALOG YOU WILL FIND SYMBOLS, SIMILAR TO THE ONE BELOW, THAT REPRESENT THE "DISPLAY PACKED" ITEMS. THE FOUR "DISPLAY PACK" STYLES ARE ILLUSTRATED BELOW.



BAG



BLISTER PACK



BUBBLE PACK



SKIN PACK

SETS OF NAVIGATION LIGHTS

The lights that appear on this page are sets of navigation lights that complement each other in styling and design. They appear on the following pages grouped by function, rather than by style; therefore, use this page as a guide for selection of individual lights to form a series. A representative variety of available finishes (e.g. white, chrome or black) are shown below - refer to the lights as listed on the following pages for specific availability in the desired style.

For Use on Power Driven Vessels Under 20 Meters (65.6 ft.) in Length.



Fig. 253
Side Lights



Fig. 252
Bi-Color



Fig. 254
Side Lights

For Use on Sail or Power Driven Vessels Under 12 Meters (39.4 ft.) in Length.



Fig. 915
Side Lights



Fig. 904
Bi-Color



Fig. 955
Side Lights

For Use on Sail or Power Driven Vessels Under 12 Meters (39.4 ft.) in Length.



Fig. 963
Side Lights



Fig. 972
Bi-Color



Fig. 965
Stern



Fig. 945
Stern



Fig. 964
Masthead

Fig. 120 Series: For Use on Sail or Power Driven Vessels Under 12 Meters (39.4 ft.) in Length.

Fig. 170 Series: For Use on Sail or Power Driven Vessels Under 20 Meters (65.6 ft.) in Length.



Fig. 120/170
Side Lights



Fig. 120/170
Bi-Color



Fig. 120/170
Stern



Fig. 120/170
Masthead

Note: This Series of Lights Also Appears on Pages 30 to 32 as a Complete Series.

BI-COLOR LIGHTS

PATENT No. 4,500,947

RED AND GREEN LENSES, COMPLETE WITH 12 VOLT BULB.

FIG. 1310 - CHROME PLATED ZINC WITH BLACK PLASTIC BASE
FIG. 1161 - CHROME PLATED BRONZE WITH BLACK PLASTIC BASE
 For Use on Power Driven Vessels Under 12 Meters (39.4 ft.) in Length.



FIG. 1310 & 1161

1 MILE VISIBILITY

chromalex®

ORDERING INFORMATION

Dimensions Base Inches	Vertical Height Inches	Display Pkg. - 5 Cards 1 Pc. per Card	OEM Bulk Pkg. 50 Pcs.	Screw Size	Weight Ounces
4 x 3-1/8	1	1310 DP CHR	1310 000 CHR	8	5-1/2
4 x 3-1/8	1	1161 DP CHR	1161 000 CHR	8	5-1/2

Spare Bulbs (2 per card), Cat. No. 71 DP CLR. Spare Lens Set (1-Red & 1-Green), Cat. No. 283 DPA LNS.
 Spare Base with Socket Assembly, Cat. No. 136.



FIG. 1218 - CHROME PLATED ZINC WITH FLAG STAFF SOCKET
 For Use on Power Driven Vessels Under 12 Meters (39.4 ft.) in Length.



FIG. 1218

1 MILE VISIBILITY

ORDERING INFORMATION

Dimensions Base Inches	Vertical Height Inches	I.D. Socket Inches	Display Pkg. - 5 Cards 1 Pc. per Card	Screw Size	Weight Ounces
6-3/4 x 3-7/8	1-5/8	3/4	1218 DP CHR	8	12

Spare Bulbs (2 per card), Cat. No. 71 DP CLR. Spare Lens Set (1-Red & 1-Green), Cat. No. 259 DPA LNS.
 Spare Socket Assembly, Cat. No. 1218 DP 99A.



FIG. 904 - CHROME PLATED BRASS TOP WITH BLACK PLASTIC BASE
 For Use on Sail or Power Driven Vessels Under 12 Meters (39.4 ft.) in Length.



FIG. 904

1 MILE VISIBILITY

chromalex®

ORDERING INFORMATION

Length Inches	Width Inches	Vertical Height Inches	Display Pkg. - 5 Cards 1 Pc. per Card	OEM Bulk Pkg. 10 Pcs.	Screw Size	Weight Ounces
4-1/4	2-1/8	7/8	904 DP CHR	904 000 CHR	4	3-1/2

Spare Bulbs (2 per card), Cat. No. 71 DP CLR. Spare Lens Set (1-Red & 1-Green), Cat. No. 296 DP LNS.
 Spare Base with Socket Assembly, Cat. No. 107.

NOTE: To Use THE LIGHTS ON THIS PAGE IN A 24 VOLT SYSTEM, ORDER REPLACEMENT BULBS (2 PER CARD) CAT. NO. 72 DP1 CLR.

BI-COLOR LIGHTS

PATENT No. 4,500,947

RED AND GREEN LENSES, COMPLETE WITH 12 VOLT BULB.

FIG. 972 - CHROME PLATED BRASS TOP WITH BLACK PLASTIC BASE

For Use on Sail or Power Driven Vessels Under 12 Meters (39.4 ft.) in Length.

HORIZONTAL MOUNT

1 MILE VISIBILITY

chromalex®

ORDERING INFORMATION

O.D. Length Inches	Vertical Height Inches	Display Pkg. - 5 Cards 1 Pc. per Card	OEM Bulk Pkg. 25 Pcs.	Screw Size	Weight Ounces
2-3/8	7/8	972 DP CHR	972 000 CHR	4	3

Spare Bulbs (2 per card), Cat. No. 71 DP CLR.
Spare Base with Socket Assembly, Cat. No. 135.

Spare Lens Set (1 - Red & 1-Green), Cat. No. 296 DP LNS.
Spare Lens Set (1 - Red & 1-Green), Cat. No. 297 DP LNS.



Fig. 972

FIGS. 120 & 170 - CHROME PLATED BRASS TOPS WITH BLACK PLASTIC BASES

BLACK OR WHITE PLASTIC TOPS WITH BLACK PLASTIC BASES

VERTICAL MOUNT

ORDERING INFORMATION

Finish	Height Overall	Projection Overall	Width Inches	Display Pkg. 5 Cards 1 Pc. per Card	OEM Bulk Pkg. 10 Pcs.	Screw Size	Weight Ounces
	Inches	Inches	Inches				

FIGS. 120 - 1 Mile Visibility

For Use on Sail or Power Driven Vessels Under 12 Meters (39.4 ft.) in Length.

Chrome	3-5/8	2-1/2	4-1/8	120 MB DP1	120 MB 12V	10	5
Black	3-5/8	2-1/2	4-1/8	120 BB DP1	120 BB 12V	10	5
White	3-5/8	2-1/2	4-1/8	120 WB DP1	120 WB 12V	10	5

FIGS. 170 - 2 Mile Visibility

For Use on Sail or Power Driven Vessels Under 20 Meters (65.6 ft.) in Length.

Chrome	3-5/8	2-1/2	4-1/8	170 MB DP1	170 MB 12V	10	5
Black	3-5/8	2-1/2	4-1/8	170 BB DP1	170 BB 12V	10	5
White	3-5/8	2-1/2	4-1/8	170 WB DP1	170 WB 12V	10	5



Fig. 120 & 170 MB

Note: See Pages 30 through 32 for Complete Series, 24 Volt Options & Spare Parts Ordering Information.

FIG. 1201 - TRI-COLOR

For Use on Vessels Under Sail Alone Under 12 Meters (39.4 ft.) in Length.

BLACK PLASTIC AND CHROME PLATED ZINC TOP

WITH BLACK PLASTIC BASE

RED AND GREEN BI-COLOR - 1 MILE VISIBILITY

WHITE (STERN) - 2 MILE VISIBILITY

Complete with 12 Volt Bulb.

chromalex®

ORDERING INFORMATION

Vertical Height Inches	Dimensions Base Inches	Display Pkg. - 5 Cards 1 Pc. per Card	OEM Bulk Pkg. 50 Pcs.	Screw Size	Weight Ounces
3-1/4	1 x 2-5/8	1201 DP BLK	1201 000 BLK	8	7

Spare Bulbs (2 per card), Cat. No. 71 DP CLR.

Spare White Lenses (2 per card), Cat. No. 278 DP WHT.

Spare Bi-Color Lens Set (1-Red & 1-Green), Cat. No. 268 DP LNS.

Spare Top Cap with Screw, Cat. No. 1158 DP BLK.



Fig. 1201

NOTE: TO USE THE LIGHTS ON THIS PAGE (EXCEPT FIGS. 120 & 170) IN A 24 VOLT SYSTEM, ORDER REPLACEMENT BULBS (2 PER CARD) CAT. No. 72 DP1 CLR.

BI-COLOR LIGHTS & REMOVABLE BI-COLOR LIGHTS

PATENT No. 4,500,947

RED AND GREEN LENSES, COMPLETE WITH BULBS AS SPECIFIED BELOW.



FIG. 252 - BI-COLOR LIGHT

For Use on Power Driven Vessels under 20 Meters (65.6 ft.) in Length (12 or 24 Volt.)

2 MILE VISIBILITY.



**FIG. 252
CHROME TOP**

***CHROME PLATED BRONZE OR BLACK PLASTIC TOP AND BLACK PLASTIC BASE, WHITE PLASTIC TOP AND BASE WITH ULTRASONICALLY WELDED LENSES GASKETED TO THE BASE.**



**FIG. 252
PLASTIC TOP**

ORDERING INFORMATION

Finish	Length Inches	Width Inches	Height Inches	Display Pkg. 5 Cards 1 Pc. per Card	OEM Bulk Pkg. 25 Pcs.	Screw Size	Weight Ounces
Black-12V	3-1/2	2-1/4	1-5/8	252 BB DP1	252 BB 12V	8	3
Black-24V	3-1/2	2-1/4	1-5/8	252 BB DP2	252 BB 24V	8	3
White-12V	3-1/2	2-1/4	1-5/8	252 WB DP1	252 WB 12V	8	3
White-24V	3-1/2	2-1/4	1-5/8	252 WB DP2	252 WB 24V	8	3
*Chrome-12V	3-1/2	2-1/4	1-5/8	252 MB DP1	252 MB 12V	8	3
*Chrome-24V	3-1/2	2-1/4	1-5/8	252 MB DP2	252 MB 24V	8	3

Spare Bulbs (2 per card), Cat. No. 71 DP CLR.

Spare Black Base with Socket Assembly, Cat. No. 114 000 BLK.

* New Item

Spare Lens (1-Red/Green), Cat. No. 247 DP LNS.

Spare White Base with Socket Assembly, Cat. No. 114 000 WHT.

FIG. 1612 - BLACK PLASTIC TOP WITH CHROME PLATED BRASS AND BLACK PLASTIC BASE

For Use on Sail or Power Driven Vessels Under 12 Meters (39.4 ft.) in Length.

1 MILE VISIBILITY

chromalex®

ORDERING INFORMATION

Vertical Height Inches	O.D. Base Inches	Display Pkg. - 5 Cards 1 Pc. per Card	OEM Bulk Pkg. 50 Pcs.	Screw Size	Weight Ounces
9-3/4	2-1/4	1612 DP BLK	1612 000 BLK	8	7

Spare Bulbs (2 per card), Cat. No. 71 DP CLR.

Spare Lens Set For Fig. 1612 (1-Red & 1-Green), Cat. No. 283 DPA LNS.

Spare Mounting Base, Cat. No. 1045 P00 DP.



FIG. 1612

NOTE: TO USE THE LIGHTS ON THIS PAGE IN A 24 VOLT SYSTEM, ORDER REPLACEMENT BULBS (2 PER CARD) CAT. NO. 72 DP1 CLR.

REMOVABLE BI-COLOR LIGHTS

PATENT No. 4,500,947

REMOVABLE BI-COLOR LIGHT WITH UTILITY LIGHT 3/4 INCH DIAMETER ANODIZED ALUMINUM TUBE AND WATERPROOF COVER FOR BASES.



For Use on Power Driven Vessels under 20 Meters (65.6 ft.) in Length
Complete with 12 Volt Bulbs.

2 MILE VISIBILITY.

**FIG. 1421 - BLACK PLASTIC TOP WITH UTILITY LIGHT,
CHROME PLATED BRASS AND BLACK PLASTIC BASE**

**FIG. 1422 - BLACK PLASTIC TOP WITH UTILITY LIGHT,
CHROME PLATED ZINC BASE. POLE HAS A 5° ANGLE.**

**FIG. 1423 - BLACK PLASTIC TOP WITH UTILITY LIGHT, CHROME
PLATED BRASS AND BLACK PLASTIC BASE
WITH WATER RESISTANT SLIDE COVER**



Deck Illuminating Utility Light in the Rear Section of the Top,
Controlled by a Switch Located on the Top Cover.

chromalex®

ORDERING INFORMATION

Vertical Height Inches	Dimensions Base Inches	Display Pkg. - 5 Cards	OEM Bulk Pkg.	Screw Size	Weight Ounces
		1 Pc. per Card	50 Pcs.		
10	2-1/4 O.D.	1421 DP CHR	1421 000 CHR	8	8
10-1/4	3-3/4 x 1-3/4	1422 DP CHR	1422 000 CHR	8	8
10	3-1/2 x 1-1/2	1423 DP CHR	1423 000 CHR	8	8

Spare Bulbs for Bi-Color Section (2 per card), Cat. No. 71 DP CLR.
Spare Bulb for Utility Light, Cat. No. 64 000 CLR.
Spare Lens Set (1-Red & 1-Green), Cat. No. 241 DP LNS.
Spare Mounting Base for Fig. No. 1421, Cat. No. 1045 300 DP.
Spare Mounting Base for Fig. No. 1422, Cat. No. 1060 380 DP.
Spare Mounting Base for Fig. No. 1423, Cat. No. 1047 380 DP.

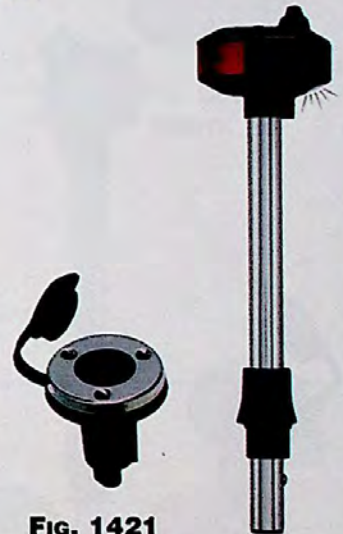

FIG. 1421

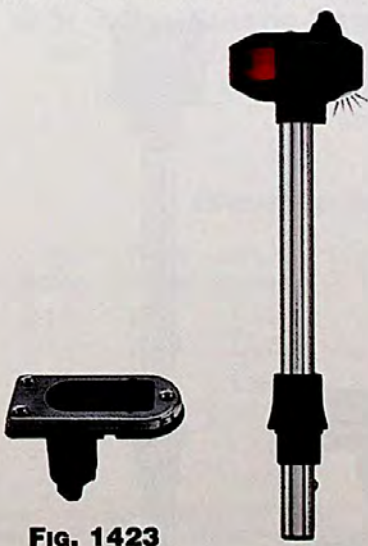

FIG. 1423

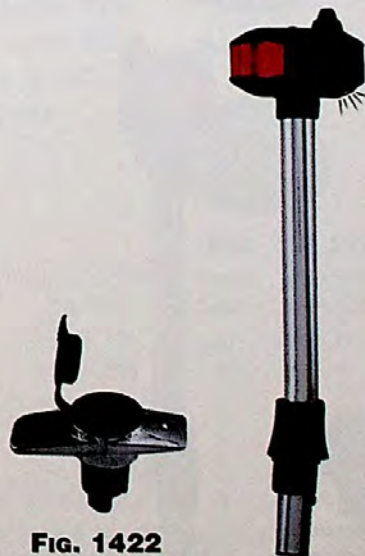

FIG. 1422

NOTE: TO USE THE LIGHTS ON THIS PAGE IN A 24 VOLT SYSTEM, ORDER REPLACEMENT BULBS (2 PER CARD) CAT. No. 72 DP1 CLR.

REMOVABLE BI-COLOR LIGHTS

PATENT No. 4,500,947

RED & GREEN LENSES, COMPLETE WITH 12 VOLT BULB.

3/4 INCH DIAMETER ANODIZED ALUMINUM TUBE AND WATERPROOF COVER FOR BASES.



FIG. 1211 - BLACK PLASTIC AND CHROME PLATED ZINC TOP WITH UTILITY LIGHT, CHROME PLATED BRASS AND BLACK PLASTIC BASE

FIG. 1212 - BLACK PLASTIC AND CHROME PLATED ZINC TOP WITH UTILITY LIGHT, CHROME PLATED ZINC BASE. POLE HAS A 5° ANGLE.

FIG. 1296 - BLACK PLASTIC AND CHROME PLATED ZINC TOP WITH UTILITY LIGHT, CHROME PLATED BRASS AND BLACK PLASTIC BASE WITH WATER RESISTANT SLIDE COVER

For Use on Sail or Power Driven Vessels Under 12 Meters (39.4 ft.) in Length.

1 MILE VISIBILITY

Deck Illuminating Utility Light in the Rear Section of the Top, Controlled by a Switch Located on the Top Cover.

chromalex®

ORDERING INFORMATION

Vertical Height Inches	Dimensions Base Inches	Display Pkg. - 5 Cards 1 Pc. per Card	OEM Bulk Pkg. 50 Pcs.	Screw Size	Weight Ounces
10	2-1/4 O.D.	1211 DP CHR	1211 000 CHR	8	8
10-1/4	3-3/4 x 1-3/4	1212 DP CHR	1212 000 CHR	8	8
10	3-1/2 x 1-1/2	1296 DP CHR	1296 000 CHR	8	8

Spare Bulbs for Bi-Color Section (2 per card), Cat. No. 71 DP CLR.
 Spare Bulb for Utility Light, Cat. No. 64 000 CLR.
 Spare Lens Set (1-Red & 1-Green), Cat. No. 268 DP LNS.
 Spare Mounting Base for Fig. No. 1211, Cat. No. 1045 300 DP.
 Spare Mounting Base for Fig. No. 1212, Cat. No. 1060 3B0 DP.
 Spare Mounting Base for Fig. No. 1296, Cat. No. 1047 3B0 DP.



Fig. 1211



Fig. 1212

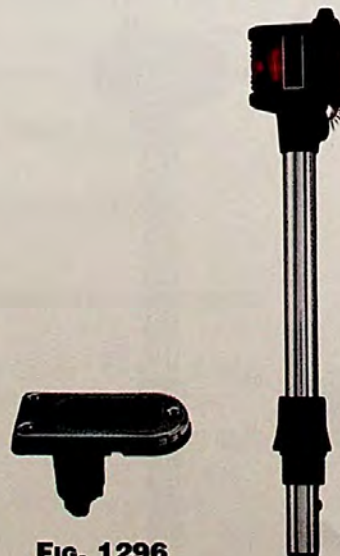

Fig. 1296

NOTE: TO USE THE LIGHTS ON THIS PAGE IN A 24 VOLT SYSTEM, ORDER REPLACEMENT BULBS (2 PER CARD) CAT. No. 72 DP1 CLR.

SIDE LIGHTS

RED AND GREEN LENSES, COMPLETE WITH 12 VOLT BULBS.

FIG. 253 - HORIZONTAL MOUNT SIDE LIGHT

For Use on Power Driven Vessels under 20 Meters
(65.6 ft.) in Length (12 or 24 Volt.)

NEW

2 MILE VISIBILITY.

***CHROME PLATED BRONZE OR BLACK PLASTIC TOP WITH BLACK PLASTIC BASE OR WHITE PLASTIC TOP AND BASE WITH ULTRASONICALLY WELDED LENSES GASKETED TO THE BASE. COMPLETE WITH 12 OR 24 VOLT BULBS**



FIG. 253 CHROME



FIG. 253 WHITE

ORDERING INFORMATION

Fig. 253 Finish	Length Inches	Width Inches	Height Inches	Display Pkg. 5 Cards 1 Pair per Card	OEM Bulk Pkg. 10 Pair	Screw Size	Weight/Pair Ounces
Black-12V	3-1/2	2-1/4	1-5/8	253 B DP1	253 B 12V	8	6
Black-24V	3-1/2	2-1/4	1-5/8	253 B DP2	253 B 24V	8	6
White-12V	3-1/2	2-1/4	1-5/8	253 W DP1	253 W 12V	8	6
White-24V	3-1/2	2-1/4	1-5/8	253 W DP2	253 W 24V	8	6
*Chrome-12V	3-1/2	2-1/4	1-5/8	253 M DP1	253 M 12V	8	6
*Chrome-24V	3-1/2	2-1/4	1-5/8	253 M DP2	253 M 24V	8	6

Fig. 253 Green Spare Lens Only, Cat. No. 273 DPG LNS.

Fig. 253 Spare Base with Socket Assembly, Cat. No. 114 000 BLK/WHT.

* New Item

Fig. 253 Red Spare Lens Only, Cat. No. 273 DPR LNS.

Spare Bulbs for Fig. 253 (2 per card), Cat. No. 71 DP CLR.

FIG. 254 - VERTICAL MOUNT SIDE LIGHT

For Use on Power Driven Vessels under 20 Meters (65.6 ft.) in Length (12 or 24 Volt.)

NEW

2 MILE VISIBILITY.

***CHROME PLATED BRONZE OR BLACK PLASTIC TOP WITH BLACK PLASTIC BASE OR WHITE PLASTIC TOP AND BASE. TOPS ARE GASKETED TO THE BASE. COMPLETE WITH 12 OR 24 VOLT BULBS**



FIG. 254 CHROME TOP



FIG. 254 BLACK TOP

ORDERING INFORMATION

Fig. 254 Finish	Length Inches	Width Inches	Height Inches	Display Pkg. 5 Cards 1 Pair per Card	OEM Bulk Pkg. 10 Pair	Screw Size	Weight/Pair Ounces
Black-12V	3-1/2	2-1/4	1-5/8	254 B DP1	254 B 12V	8	6
Black-24V	3-1/2	2-1/4	1-5/8	254 B DP2	254 B 24V	8	6
White-12V	3-1/2	2-1/4	1-5/8	254 W DP1	254 W 12V	8	6
White-24V	3-1/2	2-1/4	1-5/8	254 W DP2	254 W 24V	8	6
*Chrome-12V	3-1/2	2-1/4	1-5/8	254 M DP1	254 M 12V	8	6
*Chrome-24V	3-1/2	2-1/4	1-5/8	254 M DP2	254 M 24V	8	6

Fig. 254 Green Spare Lens Only, Cat. No. 277 DPG LNS.

Fig. 254 Spare Base with Socket Assembly, Cat. No. 254 BLK/WHT 99A.

* New Item

Fig. 254 Red Spare Lens Only, Cat. No. 277 DPR LNS.

12 Volt Spare Bulbs for Fig. 254 (2 per card), Cat. No. 71 DP8 CLR.

24 Volt Spare Bulbs for Fig. 254 (2 per card), Cat. No. 72 DP8 CLR.

NOTE: To Use THE LIGHTS ON THIS PAGE IN A 24 VOLT SYSTEM, ORDER REPLACEMENT BULBS (2 PER CARD) CAT. No. 72 DP1 CLR.

SIDE LIGHTS

RED AND GREEN LENSES, COMPLETE WITH 12 VOLT BULBS.



FIG. 915 - CHROME PLATED BRASS TOPS WITH BLACK PLASTIC BASES

For Use on Sail or Power Driven Vessels Under 12 Meters (39.4 ft.) in Length.

HORIZONTAL SURFACE MOUNT
1 MILE VISIBILITY

chromalex®

ORDERING INFORMATION



FIG. 915

Length Inches	Width Inches	Vertical Height Inches	Display Pkg. - 5 Cards 1 Pair per Card	OEM Bulk Pkg. 10 Pair	Screw Size	Weight Per Pair Ounces
4-1/4	2-3/8	7/8	915 DP CHR	915 000 CHR	4	7

Green Side Light Only, Cat. No. 915 G00 CHR.
Red Side Light Only, Cat. No. 915 R00 CHR.
Spare Bulbs (2 per card), Cat. No. 71 DP CLR.

Spare Lens Set (1-Red & 1-Green), Cat. No. 281 DPA LNS.
Spare Base with Socket Assembly, Cat. No. 107.

FIG. 955 - CHROME PLATED BRASS TOPS WITH BLACK PLASTIC BASES

For Use on Sail or Power Driven Vessels Under 12 Meters (39.4 ft.) in Length.

VERTICAL SURFACE MOUNT
1 MILE VISIBILITY

chromalex®

ORDERING INFORMATION



FIG. 955

Length Inches	Width Inches	Vertical Height Inches	Display Pkg. - 5 Cards 1 Pair per Card	OEM Bulk Pkg. 10 Pair	Screw Size	Weight Per Pair Ounces
4-1/4	2-3/8	1-5/8	955 DP CHR	955 000 CHR	4	7

Green Side Light Only, Cat. No. 955 G00 CHR.
Red Side Light Only, Cat. No. 955 R00 CHR.
Spare Bulbs (2 per card), Cat. No. 71 DP CLR.

Spare Lens Set (1-Red & 1-Green), Cat. No. 260 DP LNS.
Spare Base with Socket Assembly, Cat. No. 955 000 99A.



FIG. 963 - CHROME PLATED BRASS TOPS WITH BLACK PLASTIC BASES

For Use on Sail or Power Driven Vessels Under 12 Meters (39.4 ft.) in Length.

HORIZONTAL SURFACE MOUNT
1 MILE VISIBILITY

chromalex®

ORDERING INFORMATION



FIG. 963

O.D. Base Inches	Vertical Height Inches	Display Pkg. - 5 Cards 1 Pair per Card	OEM Bulk Pkg. 10 Pair	Screw Size	Weight Per Pair Ounces
2-3/8	7/8	963 DP CHR	963 000 CHR	4	6

Green Side Light Only, Cat. No. 963 G00 CHR.
Red Side Light Only, Cat. No. 963 R00 CHR.
Spare Bulbs (2 per card), Cat. No. 71 DP CLR.

Spare Lens Set (1-Red & 1-Green), Cat. No. 281 DPA LNS.
Spare Base with Socket Assembly, Cat. No. 135.

NOTE: TO USE LIGHTS ON THIS PAGE IN A 24 VOLT SYSTEM, ORDER REPLACEMENT BULBS (2 PER CARD) CAT. NO. 72 DP1 CLR.

SIDE LIGHTS

RED AND GREEN LENSES, COMPLETE WITH 12 VOLT OR 24 VOLT BULBS.

FIGS. 120 AND 170 - CHROME PLATED BRASS TOPS WITH BLACK PLASTIC BASES, BLACK OR WHITE PLASTIC TOPS WITH BLACK PLASTIC BASES.

VERTICAL MOUNT



Height Overall Inches	Projection Overall Inches	Width Inches	Screw Size	Weight Ounces
3-5/8	2-1/2	4-1/8	10	5



FIGS. 120 MSD & 170 MSD

**FIG. 120 - FOR USE ON
SAIL OR POWER DRIVEN VESSELS UNDER
12 METERS (39.4 FT.) IN LENGTH (12 VOLTS).**



FIGS. 120 MP & 170 MP

1 MILE VISIBILITY

ORDERING INFORMATION - 12 VOLT



FIGS. 120 BSD & 170 BSD

Description	Display Pkg. 5 - Cards 1 Pc. per Card	OEM Bulk Pkg. 10 Pcs.
Chrome		
Red Side Light	120 MP DP1	120 MP 12V
Green Side Light	120 MSD DP1	120 MSD 12V
Black Plastic		
Red Side Light	120 BP DP1	120 BP 12V
Green Side Light	120 BSD DP1	120 BSD 12V
White Plastic		
Red Side Light	120 WP DP1	120 WP 12V
Green Side Light	120 WSD DP1	120 WSD 12V



FIGS. 120 BP & 170 BP



FIGS. 120 WSD & 170 WSD

**FIG. 170 - FOR USE ON SAIL OR POWER DRIVEN
VESSELS UNDER 20 METERS (65.6 FT.) IN LENGTH
(12 OR 24 VOLTS).**

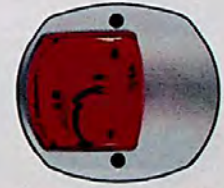

FIGS. 120 WP & 170 WP

2 MILE VISIBILITY

ORDERING INFORMATION - 12 VOLT

Description	Display Pkg. 5 - Cards 1 Pc. per Card	Std Pkg.- 1 Pc. OEM Pkg. - 10 Pcs.
Chrome		
Red Side Light	170 MP DP1	170 MP 12V
Green Side Light	170 MSD DP1	170 MSD 12V
Black Plastic		
Red Side Light	170 BP DP1	170 BP 12V
Green Side Light	170 BSD DP1	170 BSD 12V
White Plastic		
Red Side Light	170 WP DP1	170 WP 12V
Green Side Light	170 WSD DP1	170 WSD 12V

ORDERING INFORMATION - 24 VOLT

Description	Display Pkg. 5 - Cards 1 Pc. per Card	Std Pkg.- 1 Pc. OEM Pkg. - 10 Pcs.
Chrome		
Red Side Light	170 MP DP2	170 MP 24V
Green Side Light	170 MSD DP2	170 MSD 24V
Black Plastic		
Red Side Light	170 BP DP2	170 BP 24V
Green Side Light	170 BSD DP2	170 BSD 24V
White Plastic		
Red Side Light	170 WP DP2	170 WP 24V
Green Side Light	170 WSD DP2	170 WSD 24V

Note: See Pages 30 through 32 for Complete Series, 24 Volt Options & Spare Parts Ordering Information.

NAVIGATION LIGHTS FOR VESSELS UNDER 20 METERS

SIDE LIGHTS



FIG. 1601 - BLACK PLASTIC - NORMAL "BASE-DOWN" MOUNT
FIG. 1602 - BLACK PLASTIC - INVERTED "BASE-UP" MOUNT

For Use on Sail or Power Driven Vessels under 12 Meters (39.4 ft.) In Length.
 Complete with 12 Volt Bulb.



FIG. 1601

1 MILE VISIBILITY



FIG. 1602

ORDERING INFORMATION

Finish	Vertical Height Inches	Height Overall Inches	Dimensions Base Inches	Display Pkg. - 5 Cards 1 Pair per Card	OEM Bulk Pkg. 25 Pair	Screw Size	Weight Ounces
Black	1-1/8	1-7/8	1-1/8 x 3	1601 DP BLK	1601 000 BLK	8	2-1/4
Black	1-1/8	1-7/8	1-1/8 x 3	1602 DP BLK	1602 000 BLK	8	2-1/4

Spare Bulbs (2 per card), Cat No. 71 DP CLR. Red Spare Lens Only, Cat. No. 298 DPR LNS.
 Spare Base with Socket Assembly, Cat. No. 139 000 BLK. Green Spare Lens Only, Cat. No. 298 DPG LNS.



FIG. 1264 - CHROME PLATED ZINC WITH BLACK VINYL MOUNTING GASKET

VERTICAL SURFACE MOUNT

For Use on Power Driven Vessels under 12 Meters (39.4 ft.) in Length
 Complete with 12 Volt Bulb.



1 MILE VISIBILITY



FIG. 1264

ORDERING INFORMATION

Length Inches	Width Inches	Projection Overall Inches	Display Pkg. - 5 Cards 1 Pair per Card	Screw Size	Weight Per Pair Pounds
5-1/2	3-1/8	1-3/4	1264 DP CHR	8	1

Green Side Light Only, Cat. No. 1264 G00 CHR. Spare Lens Set (1-Red & 1-Green), Cat. No. 1264 DP LNS.
 Red Side Light Only, Cat. No. 1264 R00 CHR. Spare Socket Assembly, Cat. No. 1264 DP 99A.
 Spare Bulbs (2 per card), Cat. No. 71 DP CLR.

NOTE: TO USE THE LIGHTS ON THIS PAGE IN A 24 VOLT SYSTEM, ORDER REPLACEMENT BULBS (2 PER CARD) CAT. NO. 72 DP1 CLR.

STERN LIGHTS

CLEAR LENSES, COMPLETE WITH 12 VOLT BULB.

FIG. 945 - CHROME PLATED BRASS TOPS WITH BLACK PLASTIC BASE VERTICAL SURFACE MOUNT - 2 MILE VISIBILITY

For Use on Sail or Power Driven Vessels under 20 Meters (65.6 ft.) In Length.



FIG. 965 - CHROME PLATED BRASS TOPS WITH BLACK PLASTIC BASE HORIZONTAL SURFACE MOUNT - 2 MILE VISIBILITY

For Use on Sail or Power Driven Vessels under 20 Meters (65.6 ft.) In Length.



FIG. 945

chromalex

ORDERING INFORMATION



FIG. 965

Mount	O.D. Base Inches	Proj. Height Overall Inches	Display Pkg. - 5 Cards 1 Pc. per Card	OEM Bulk Pkg. 25 Pcs.	Screw Size	Weight Ounces
Vertical	2-3/8	1-5/8	945 DP CHR	945 000 CHR	4	3
Horizontal	2-3/8	1-5/8	965 DP CHR	965 000 CHR	4	3

Spare Bulbs For Both (2 per card), Cat. No. 71 DP CLR. Spare Lens For Fig. No. 945, Cat. No. 74 DP WHT.
Spare Base and Socket Assembly For Fig. 945, Cat. No. 945 DP 99A. Spare Lens For Fig. No. 965, Cat. No. 281 DPA WHT.
Spare Base and Socket Assembly For Fig. 965, Cat. No. 135.

NOTE: TO USE THE ABOVE LIGHTS IN A 24 VOLT SYSTEM, ORDER REPLACEMENT BULBS (2 PER CARD) CAT. NO. 72 DP1 CLR.

FIG. 939 - CHROME PLATED BRASS TOP WITH BLACK PLASTIC BASE VERTICAL FLUSH MOUNT - 2 MILE VISIBILITY

For Use on Sail or Power Driven Vessels under 20 Meters (65.6 ft.) In Length.



chromalex

ORDERING INFORMATION

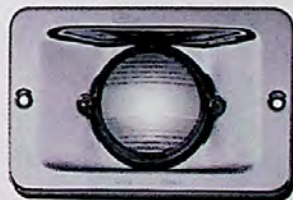

FIG. 939

Voltage	Dimensions Inches	Depth Inches	Display Pkg. - 5 Cards 1 Pc. per Card	OEM Bulk Pkg. 20 Pcs.	Screw Size	Weight Ounces
12 Volt	5-3/16 x 3-3/8	1-1/2	939 DP1 12V	939 001 12V	8	4
32 Volt	5-3/16 x 3-3/8	1-1/2	939 DP3 32V	-----	8	4

Spare 12 Volt Bulbs (2 per card), Cat. No. 70 DP0 CLR. Spare 12 Volt Socket Assembly, Cat. No. 939 DP1 99A.
Spare 32 Volt Bulbs (2 per card), Cat. No. 70 DP2 CLR. Spare 32 Volt Socket Assembly, Cat. No. 939 003 99A.
Spare Lens with Gasket, Cat. No. 284 DP CLR. Spare Mounting Flange, Cat. No. 939 000 99C.

FIG. 946 - CHROME PLATED BRASS WITH BLACK PLASTIC BASE VERTICAL FLUSH MOUNT - 2 MILE VISIBILITY

For Use on Sail or Power Driven Vessels under 20 Meters (65.6 ft.) In Length.



chromalex

ORDERING INFORMATION



FIG. 946

Voltage	O.D. Inches	Depth Inches	Display Pkg. - 5 Cards 1 Pc. per Card	OEM Bulk Pkg. 25 Pcs.	Screw Size	Weight Ounces
12 Volt	3	1	946 DP1 12V	946 001 12V	8	4
32 Volt	3	1	946 DP3 32V	-----	8	4

Spare 12 Volt Bulbs (2 per card), Cat. No. 70 DP0 CLR. Spare 12 Volt Socket Assembly, Cat. No. 946 DP1 99B.
Spare 32 Volt Bulbs (2 per card), Cat. No. 70 DP2 CLR. Spare 32 Volt Socket Assembly, Cat. No. 946 003 99B.
Spare Lens with Gasket, Cat. No. 946 DP 99A. Spare Mounting Flange, Cat. No. 946 000 99C.

STERN LIGHTS

CLEAR LENS, COMPLETE WITH 12 VOLT OR 24 VOLT BULB.

FIG. 120 - CHROME PLATED BRASS TOPS WITH BLACK PLASTIC BASES, BLACK OR WHITE PLASTIC TOPS WITH BLACK PLASTIC BASES

FIG. 170 - CHROME PLATED BRASS TOPS WITH BLACK PLASTIC BASES, BLACK OR WHITE PLASTIC TOPS WITH BLACK PLASTIC BASES

For Use on Sail or Power Driven Vessels Under 20 Meters (65.6 ft.) in Length.
VERTICAL SURFACE MOUNT - 2 MILE VISIBILITY
12 Volt or 24 Volt Bulbs



Figs. 120 MSN & 170 MSN



Figs. 120 BSN & 170 BSN



Figs. 120 WSN & 170 WSN

ORDERING INFORMATION - FOR 12 VOLT LIGHTS

Finish	Height Overall Inches	Projection Overall Inches	Width Inches	Display Pkg. - 5 Cards 1 Pc. per Card	OEM Bulk Pkg. 10 Pcs.	Screw Size	Weight Ounces
Fig. 120							
Chrome	3-5/8	2-1/2	4-1/8	120 MSN DP1	120 MSN 12V	10	5
Black	3-5/8	2-1/2	4-1/8	120 BSN DP1	120 BSN 12V	10	5
White	3-5/8	2-1/2	4-1/8	120 WSN DP1	120 WSN 12V	10	5
Fig. 170							
Chrome	3-5/8	2-1/2	4-1/8	170 MSN DP1	170 MSN 12V	10	5
Black	3-5/8	2-1/2	4-1/8	170 BSN DP1	170 BSN 12V	10	5
White	3-5/8	2-1/2	4-1/8	170 WSN DP1	170 WSN 12V	10	5

ORDERING INFORMATION - FOR 24 VOLT LIGHTS

Finish	Height Overall Inches	Projection Overall Inches	Width Inches	Display Pkg. - 5 Cards 1 Pc. per Card	OEM Bulk Pkg. 10 Pcs.	Screw Size	Weight Ounces
Chrome	3-5/8	2-1/2	4-1/8	170 MSN DP2	170 MSN 24V	10	5
Black	3-5/8	2-1/2	4-1/8	170 BSN DP2	170 BSN 24V	10	5
White	3-5/8	2-1/2	4-1/8	170 WSN DP2	170 WSN 24V	10	5

NOTE: See Pages 30 through 32 for Complete Series, 24 Volt Options and Spare Parts Ordering Information.



FIG. 1332 - CHROME PLATED ZINC WITH BLACK PLASTIC BASE
 For Use on Sail or Power Driven Vessels Under 20 Meters (65.6 ft.) in Length.
VERTICAL SURFACE MOUNT - 2 MILE VISIBILITY
Complete with 12 Volt Bulb.

chromalex®

ORDERING INFORMATION

Length Inches	Width Inches	Display Pkg. - 5 Cards 1 Pc. per Card	OEM Bulk Pkg. 50 Pcs.	Screw Size	Weight Ounces
3-3/4	1-1/2	1332 DP CHR	1332 000 CHR	4	4

Spare Bulbs (2 per card), Cat. No. 71 DP CLR.

Spare Lenses (2 per card) Cat. No. 278 DP WHT.

NOTE: TO USE THIS LIGHT IN A 24 VOLT SYSTEM, ORDER REPLACEMENT BULBS (2 PER CARD) CAT. NO. 72 DP1 CLR

MASTHEAD LIGHTS

CLEAR LENS, COMPLETE WITH 12 VOLT OR 24 VOLT BULB.

FIG. 120 - CHROME PLATED BRASS TOPS WITH BLACK PLASTIC BASES, BLACK OR WHITE PLASTIC TOPS WITH BLACK PLASTIC BASES

For Use On Sail or Power Driven Vessels Under 12 Meters (39.4 ft.) in Length.

VERTICAL SURFACE MOUNT

2 Mile Visibility - 12 Volt Bulbs.

FIG. 170 - CHROME PLATED BRASS TOPS WITH BLACK PLASTIC BASES, BLACK OR WHITE PLASTIC TOPS WITH BLACK PLASTIC BASES

For Use On Vessels Under 20 Meters (65.6 ft.) in Length.

VERTICAL SURFACE MOUNT

3 Mile Visibility - 12 Volt or 24 Volt Bulbs.



Figs. 120 MM & 170 MM



Figs. 120 BM & 170 BM

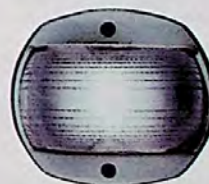

Figs. 120 WM & 170 WM

ORDERING INFORMATION - FOR 12 VOLT LIGHTS

Finish	Height Overall Inches	Projection Overall Inches	Width Inches	Display Pkg. - 5 Cards 1 Pc. per Card	OEM Bulk Pkg. 10 Pcs.	Screw Size	Weight Ounces
Fig. 120							
Chrome	3-5/8	2-1/2	4-1/8	120 MM DP1	120 MM 12V	10	5
Black	3-5/8	2-1/2	4-1/8	120 BM DP1	120 BM 12V	10	5
White	3-5/8	2-1/2	4-1/8	120 WM DP1	120 WM 12V	10	5
Fig. 170							
Chrome	3-5/8	2-1/2	4-1/8	170 MM DP1	170 MM 12V	10	5
Black	3-5/8	2-1/2	4-1/8	170 BM DP1	170 BM 12V	10	5
White	3-5/8	2-1/2	4-1/8	170 WM DP1	170 WM 12V	10	5

ORDERING INFORMATION - FOR 24 VOLT LIGHTS

Finish	Height Overall Inches	Projection Overall Inches	Width Inches	Display Pkg. - 5 Cards 1 Pc. per Card	OEM Bulk Pkg. 10 Pcs.	Screw Size	Weight Ounces
Chrome	3-5/8	2-1/2	4-1/8	170 MM DP2	170 MM 24V	10	5
Black	3-5/8	2-1/2	4-1/8	170 BM DP2	170 BM 24V	10	5
White	3-5/8	2-1/2	4-1/8	170 WM DP2	170 WM 24V	10	5

NOTE: See Pages 30 through 32 for Complete Series, 24 Volt Options and Spare Parts Ordering Information.

FIG. 120/170 BMD - COMBINATION MASTHEAD AND DECK SPREADER LIGHT, BLACK PLASTIC VERTICAL SURFACE MOUNT

Fig. 120 BMD - 2 Mile Visibility, 12 Volt Bulbs.

For Use On Sail or Power Driven Vessels Under 12 Meters (39.4 ft.) in Length.

Fig. 170 BMD* - 3 Mile Visibility, 12 Volt Bulbs.

For Use On Sail or Power Driven Vessels Under 12 Meters (39.4 ft.) in Length.

ORDERING INFORMATION

Height Overall Inches	Projection Overall Inches	Width Inches	Display Pkg. - 5 Cards 1 Pc. per Card	OEM Bulk Pkg. 10 Pcs.	Screw Size	Weight Ounces
7	4-3/4	4-1/8	120 BMD DP1	120 BMD 12V	10	18-1/2
7	4-3/4	4-1/8	170 BMD DP1*	170 BMD 12V*	10	18-1/2

NOTE: See Page 30 for Spare Parts Ordering Information.



Fig. 120/170 BMD

* New Item

MASTHEAD LIGHTS

CLEAR LENS, COMPLETE WITH 12 VOLT BULB.



FIG. 964 - CHROME PLATED BRASS TOP WITH BLACK PLASTIC BASE
For Use On Sail or Power Driven Vessels Under 12 Meters (39.4 ft.) in Length.

HORIZONTAL SURFACE MOUNT
2 Mile Visibility

chromalex®

ORDERING INFORMATION



FIG. 964

O.D. Base Inches	Vertical Height Inches	Display Pkg. - 5 Cards 1 Pc. per Card	OEM Bulk Pkg. 25 Pcs.	Screw Size	Weight Ounces
2-3/8	7/8	964 DP CHR	964 000 CHR	4	3

Spare Bulbs (2 per card), Cat. No. 71 DP CLR.
Spare Lens, Cat No. 281 DPA WHT.

Spare Base with Socket Assembly, Cat. No. 135



FIG. 1331 - CHROME PLATED ZINC WITH BLACK PLASTIC BASE
For Use On Sail or Power Driven Vessels Under 12 Meters (39.4 ft.) in Length.

VERTICAL SURFACE MOUNT
3 Mile Visibility

chromalex®

ORDERING INFORMATION



FIG. 1331

Length Inches	Width Inches	Display Pkg. - 5 Cards 1 Pc. per Card	OEM Bulk Pkg. 50 Pcs.	Screw Size	Weight Ounces
3-3/4	1-1/2	1331 DP CHR	1331 000 CHR	4	4

Spare Bulbs (2 per card), Cat. No. 71 DP CLR.

Spare Lenses (2 per card) Cat. No. 278 DP WHT.



FIG. 1178 - BLACK PLASTIC AND CHROME PLATED ZINC TOP WITH CHROME PLATED ZINC BASE

For Use On Vessels Under 20 Meters (65.6 ft.) in Length.

HORIZONTAL SURFACE MOUNT
3 Mile Visibility

chromalex®

ORDERING INFORMATION



FIG. 1178

Vertical Height Inches	Dimensions Base Inches	Display Pkg. - 5 Cards 1 Pc. per Card	OEM Bulk Pkg. 50 Pcs.	Screw Size	Weight Ounces
3-1/4	1 x 2-5/8	1178 DP CHR	1178 000 CHR	8	7

Spare Bulbs (2 per card), Cat. No. 71 DP CLR.

Spare Lenses (2 per card), Cat. No. 278 DP WHT.

Spare Top Cap and Screw, Cat. No. 1158 DP BLK.

NOTE: TO USE THE LIGHTS ON THIS PAGE IN A 24 VOLT SYSTEM, ORDER REPLACEMENT BULBS (2 PER CARD) CAT. NO. 72 DP1 CLR.

COMBINATION MASTHEAD AND WHITE ALL-ROUND LIGHTS

**CLEAR LENSES, COMPLETE WITH TWO 12 VOLT BULBS.
BLACK PLASTIC AND CHROME PLATED ZINC TOPS WITH CHROME PLATED ZINC BASES.
3/4 INCH DIAMETER ANODIZED ALUMINUM TUBES.**

**FIG. 1181 - FOLD-DOWN, ADJUSTABLE ANGLE, HORIZONTAL MOUNT
FIG. 1184 - FOLD-DOWN, ADJUSTABLE ANGLE, VERTICAL MOUNT**



**PLASTIC ADAPTERS FOR FLAT OR "V" TYPE MOUNT,
CONTAINS NOTCH FOR THROUGH-BASE WIRING**

3 MILE VISIBILITY

For Use on Sail or Power Driven Vessels Under 20 Meters (65.6 ft.) in Length.

chromalex

ORDERING INFORMATION

Vertical Height Inches	Dimensions Base Inches	Display Pkg. - 5 Cards 1 Pc. per Card	OEM Bulk Pkg. 50 Pcs.	Screw Size	Weight Pounds
12-5/8	2 x 1-1/2	1181 DP CHR	1181 000 CHR	8	3/4
12-5/8	2-1/4 x 5/8	1184 DP CHR	1184 000 CHR	8	3/4

For Fig. 1181, Spare Bracket with Knob and End Plug, Cat. No. 1052 DPA CHR.
For Fig. 1184, Spare Bracket with Knob and End Plug, Cat. No. 1054 DPA CHR.
Spare Knob, Cat. No. 1144 A00 BLK.

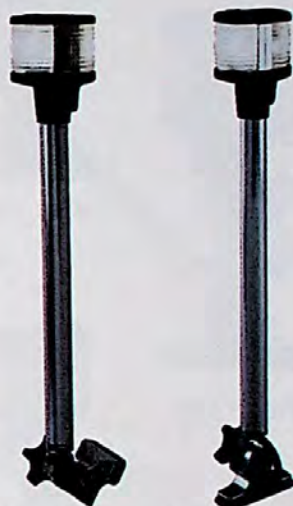

FIG. 1181

FIG. 1184

NOTE: TO USE THE LIGHTS ABOVE IN A 24 VOLT SYSTEM, ORDER REPLACEMENT BULBS (2 PER CARD) CAT. No. 72 DP1 CLR.

"REDUCED GLARE" DESIGN

**FIG. 1281 - FOLD-DOWN, ADJUSTABLE ANGLE, HORIZONTAL MOUNT
FIG. 1284 - FOLD-DOWN, ADJUSTABLE ANGLE, VERTICAL MOUNT**



**PLASTIC ADAPTERS FOR FLAT OR "V" TYPE MOUNT,
CONTAINS NOTCH FOR THROUGH-BASE WIRING**

2 MILE VISIBILITY

For Use on Power Driven Vessels Under 12 Meters (39.4 ft.) in Length.

chromalex

ORDERING INFORMATION

Vertical Height Inches	Dimensions Base Inches	Display Pkg. - 5 Cards 1 Pc. per Card	OEM Bulk Pkg. 50 Pcs.	Screw Size	Weight Pounds
12-3/4	2 x 1-1/2	1281 DP CHR	1281 000 CHR	8	3/4
12-3/4	2-1/4 x 5/8	1284 DP CHR	1284 000 CHR	8	3/4

For Fig. 1281, Spare Bracket with Knob and End Plug, Cat. No. 1052 DPA CHR.
For Fig. 1284, Spare Bracket with Knob and End Plug, Cat. No. 1054 DPA CHR.
Spare Knob, Cat. No. 1144 A00 BLK.

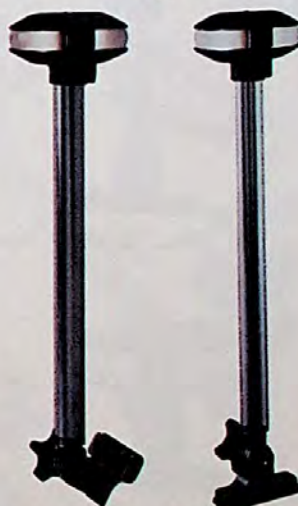

FIG. 1281

FIG. 1284

SPARE PARTS ORDERING INFORMATION

FOR FIGS. 1181 & 1184

Spare Bulbs (2 per card), Cat. No. 71 DP CLR.
Spare Lenses (2 per card), Cat. No. 278 DP WHT.
Spare Top Cap with Screw, Cat. No. 1158 DP BLK.

FOR FIGS. 1281 & 1284

Spare Bulbs (2 per card), Cat. No. 338 DP1 CLR.
Spare Lenses (2 per card), Cat. No. 240 DP LNS.

COMBINATION MASTHEAD AND WHITE ALL-ROUND LIGHTS

**CLEAR LENSES, COMPLETE WITH TWO 12 VOLT BULBS.
BLACK PLASTIC AND CHROME PLATED ZINC TOPS WITH BLACK PLASTIC BASES.
3/4 INCH DIAMETER ANODIZED ALUMINUM TUBES.**



Fig. 1196



Fig. 1183



Fig. 1197

FIGS. 1183 AND 1196 - FIXED MOUNT

For Use on Sail or Power Driven Vessels Under 20 Meters (65.6 ft.) in Length.

3 MILE VISIBILITY

chromalex®

ORDERING INFORMATION

Vertical Height Inches	Dimensions Base Inches	Display Pkg. - 5 Cards		OEM Bulk Pkg. 50 Pcs.	Screw Size	Weight Ounces
		1 Pc. per Card				
3-1/4	1 x 2-5/8	1183 DP CHR		1183 000 CHR	8	7
5-1/4	1 x 2-5/8	1196 DP1 CHR		1196 001 CHR	8	8
11-1/4	1 x 2-5/8	1196 DP2 CHR		1196 002 CHR	8	8

FIG. 1197 - FIXED MOUNT

For Use on Sail or Power Driven Vessels Under 20 Meters (65.6 ft.) in Length.

3 MILE VISIBILITY

chromalex®

ORDERING INFORMATION

Vertical Height Inches	Length Tubing Inches	Display Pkg. - 5 Cards		OEM Bulk Pkg. 50 Pcs.	Screw Size
		1 Pc. per Card			
3-1/4	1	1197 DP CHR		1197 000 CHR	7

NOTE: TO USE THE LIGHTS ABOVE IN A 24 VOLT SYSTEM, ORDER REPLACEMENT BULBS (2 PER CARD) CAT. No. 72 DP1 CLR.



Fig. 1236



FIG. 1236 - "REDUCED GLARE" DESIGN - FIXED MOUNT

For Use on Power Driven Vessels Under 12 Meters (39.4 ft.) in Length.

2 MILE VISIBILITY

chromalex®

ORDERING INFORMATION

Vertical Height Inches	Dimensions Base Inches	Display Pkg. - 5 Cards		OEM Bulk Pkg. 50 Pcs.	Screw Size	Weight Ounces
		1 Pc. per Card				
4-1/4	1 x 2-5/8	1236 DP1 BLK		1236 001 BLK	8	7
10-1/2	1 x 2-5/8	1236 DP2 BLK		1236 002 BLK	8	8

FIG. 1283 - "REDUCED GLARE" DESIGN - FIXED MOUNT

For Use on Power Driven Vessels Under 12 Meters (39.4 ft.) in Length.

2 MILE VISIBILITY

chromalex®

ORDERING INFORMATION

Vertical Height Inches	Dimensions Base Inches	Display Pkg. - 5 Cards		OEM Bulk Pkg. 50 Pcs.	Screw Size	Weight Ounces
		1 Pc. per Card				
2-1/2	1 x 2-5/8	1283 DP BLK		1283 000 BLK	8	7



Fig. 1283

SPARE PARTS ORDERING INFORMATION

FOR FIGS. 1183, 1196 & 1197

Spare Bulbs (2 per card), Cat. No. 71 DP CLR.
Spare Lenses (2 per card), Cat. No. 278 DP WHT.
Spare Top Cap with Screw, Cat. No. 1158 DP BLK.

FOR FIGS. 1236 & 1283

Spare Bulbs (2 per card), Cat. No. 338 DP1 CLR.
Spare Lenses (2 per card), Cat. No. 240 DP LNS.

NAVIGATION LIGHTS FOR VESSELS UNDER 20 METERS

COMBINATION MASTHEAD AND WHITE ALL-ROUND LIGHTS

STOW-A-WAY PLUG-IN TYPE
CLEAR LENSES, COMPLETE WITH TWO 12 VOLT BULBS.
BLACK PLASTIC AND CHROME PLATED ZINC TOP, 3/4 INCH DIAMETER ANODIZED
ALUMINUM TUBES, WATERPROOF COVER FOR BASES.

FIG. 1123 - HORIZONTAL MOUNT

FIG. 1124 - VERTICAL MOUNT

For Use on Sail or Power Driven Vessels Under 20 Meters (65.6 ft.) in Length.
3 MILE VISIBILITY

Chrome Plated Zinc Mounting Bracket
Plastic Adapters for Flat or "V" Type 45 Degree Windshields

chromalex®

ORDERING INFORMATION

Vertical Height Inches	Display Pkg. - 5 Cards 1 Pc. per Card	OEM Bulk Pkg. 50 Pcs.	Screw Size	Weight Pounds
11-1/2	1123 DP1 CHR	1123 001 CHR	8	1
11-1/2	1124 DP1 CHR	1124 001 CHR	8	1
20-3/4	1123 DP2 CHR	1123 002 CHR	8	1-1/8
20-3/4	1124 DP2 CHR	1124 002 CHR	8	1-1/8

Spare Bulb (2 per card), Cat. No. 71 DP CLR.
 Spare Lenses (2 per card), Cat. No. 278 DP WHT.
 Spare Top Cap with Screw, Cat. No. 1158 DP BLK.

Spare Cap for Base, Cat No. 125 DP BLK.
 Spare Base with Socket Assembly, Cat No. 1123 DP 99A.
 Spare Base with Socket Assembly, Cat No. 1124 DP 99A.

NOTE: TO USE THE LIGHTS ABOVE IN A 24 VOLT SYSTEM, ORDER REPLACEMENT BULBS (2 PER CARD) CAT. NO. 72 DP1 CLR

"REDUCED GLARE" DESIGN

FIG. 1273 - HORIZONTAL MOUNT

FIG. 1274 - VERTICAL MOUNT

For Use on Power Driven Vessels Under 12 Meters (39.4 ft.) in Length.
2 MILE VISIBILITY

Chrome Plated Zinc Mounting Bracket
Plastic Adapters for Flat or "V" Type 45 Degree Windshields

chromalex®

ORDERING INFORMATION

Vertical Height Inches	Display Pkg. - 5 Cards 1 Pc. per Card	OEM Bulk Pkg. 50 Pcs.	Screw Size	Weight Pounds
11-3/4	1273 DP1 CHR	1273 001 CHR	8	1
11-3/4	1274 DP1 CHR	1274 001 CHR	8	1
21	1273 DP2 CHR	1273 002 CHR	8	1-1/8
21	1274 DP2 CHR	1274 002 CHR	8	1-1/8

Spare Bulb (2 per card), Cat. No. 338 DP1 CLR.
 Spare Lenses (2 per card), Cat. No. 240 DP LNS.
 Spare Cap for Base, Cat No. 125 DP BLK.

Spare Base with Socket Assembly, Cat No. 1123 DP 99A.
 Spare Base with Socket Assembly, Cat No. 1124 DP 99A.



FIG. 1123

FIG. 1124



FIG. 1273

FIG. 1274

COMBINATION MASTHEAD AND WHITE ALL-ROUND LIGHTS

STOW-A-WAY PLUG-IN TYPE

CLEAR LENSES, COMPLETE WITH TWO 12 VOLT BULBS.

BLACK PLASTIC AND CHROME PLATED ZINC TOP, 3/4 INCH DIAMETER ANODIZED ALUMINUM TUBES, WATERPROOF COVER FOR BASES.



FIG. 1125 - DECK MOUNT

For Use on Sail or Power Driven Vessels Under 20 Meters (65.6 ft.) in Length.

3 MILE VISIBILITY - POLE HAS 16° RAKE.

Chrome Plated Brass Base with Waterproof Cover for Base that Attaches to Deck Mounted Retainer when Light is in Place.

chromalex®

ORDERING INFORMATION



FIG. 1125

Vertical Height Inches	Dimensions Base Inches	Display Pkg. - 5 Cards 1 Pc. per Card	OEM Bulk Pkg. 50 Pcs.	Screw Size	Weight Pounds
33-5/8	3-3/8 x 2-1/4	1125 DP4 CHR	1125 004 CHR	8	1-1/2
Spare Bulb (2 per card), Cat. No. 71 DP CLR.		Spare Cover for Base, Cat No. 125 DP BLK.			
Spare Lenses (2 per card), Cat. No.278 DP WHT.		Spare Base with Socket Assembly, Cat No. 1125 DP 99A.			
Spare Top Cap with Screw, Cat. No. 1158 DP BLK.					

NOTE: To Use THE LIGHT ABOVE IN A 24 VOLT SYSTEM, ORDER REPLACEMENT BULBS (2 PER CARD) CAT. No. 72 DP1 CLR



**"REDUCED GLARE" DESIGN
FIG. 1275 - DECK MOUNT**

For Use on Power Driven Vessels Under 12 Meters (39.4 ft.) in Length.

2 MILE VISIBILITY - POLE HAS 16° RAKE.

Chrome Plated Brass Base with Waterproof Cover for Base that Attaches to Deck Mounted Retainer when Light is in Place.

chromalex®

ORDERING INFORMATION



FIG. 1275

Vertical Height Inches	Dimensions Base Inches	Display Pkg. - 5 Cards 1 Pc. per Card	OEM Bulk Pkg. 50 Pcs.	Screw Size	Weight Pounds
33-3/4	3-3/8 x 2-1/4	1275 DP4 CHR	1275 004 CHR	8	1-1/2
Spare Bulb (2 per card), Cat. No. 338 DP1 CLR.		Spare Cover for Base, Cat No. 125 DP BLK.			
Spare Lenses (2 per card), Cat. No. 240 DP LNS.		Spare Base with Socket Assembly, Cat No. 1125 DP 99A.			

WHITE ALL-ROUND LIGHTS

**STOW-A-WAY PLUG-IN TYPE - COMPLETE WITH 12 VOLT BULB
3/4 INCH DIAMETER ANODIZED TUBES WITH LOCKING COLLARS,
WATER RESISTANT SLIDE COVERS & WATER PROOF COVERS FOR BASES**

**FIG. 1640 - WHITE TRANSLUCENT GLOBE, BLACK PLASTIC TOP,
WITH BLACK PLASTIC AND CHROME PLATED BRASS BASE**

**FIG. 1430 - WHITE TRANSLUCENT GLOBE, BLACK PLASTIC TOP,
CHROME PLATED ZINC WITH BLACK PLASTIC INSERT**

For Use on Sail or Power Driven Vessels Under 20 Meters (65.6 ft.) in Length.
2 MILE VISIBILITY - POLES HAVE 5° RAKE

chromalex® ORDERING INFORMATION

Fig. 1430

Vertical Height Inches	Display Pkg. - 5 Cards 1 Pc. per Card	OEM Bulk Pkg. 50 Pcs.	Weight Pounds
21	1430 DP2 CHR	1430 002 CHR	1
27-1/4	1430 DP3 CHR	1430 003 CHR	1-1/8
33-1/2	1430 DP4 CHR	1430 004 CHR	1-1/4
40-3/4	1430 DP5 CHR	1430 005 CHR	1-3/8
46-3/4	1430 DP6 CHR	1430 006 CHR	1-1/2
51-3/4	1430 DP7 CHR	1430 007 CHR	1-5/8

Base Length 3-3/4", Width 1-3/4", Screw Size #8

Fig. 1640

Vertical Height Inches	Display Pkg. - 5 Cards 1 Pc. per Card	OEM Bulk Pkg. 50 Pcs.	Weight Pounds
20-5/8	1640 DP2 CHR	1640 002 CHR	1
27-1/8	1640 DP3 CHR	1640 003 CHR	1-1/8
33-1/4	1640 DP4 CHR	1640 004 CHR	1-1/4
40-1/2	1640 DP5 CHR	1640 005 CHR	1-3/8
46-1/2	1640 DP6 CHR	1640 006 CHR	1-1/2
51-1/2	1640 DP7 CHR	1640 007 CHR	1-5/8

Base Length 3-1/2", Width 1-1/2", Screw Size #8.

Spare Bulbs (2 per card), Cat. No. 337 012 DP. Spare Globe, Cat. No. 201 DP WHT.

Spare Bases with Socket Assembly for Fig. 1640, Cat. No. 1046 P00 DP.

Spare Bases with Socket Assembly for Fig. 1430, Cat. No. 1060 P00 DP.

**FIG. 1631 & FIG. 1660 - WHITE TRANSLUCENT GLOBE, BLACK
PLASTIC TOP, WITH BLACK PLASTIC AND CHROME PLATED BRASS BASE**

For Use on Sail or Power Driven Vessels Under 20 Meters (65.6 ft.) in Length.

2 MILE VISIBILITY chromalex® ORDERING INFORMATION

Fig. 1631

Vertical Height Inches	Display Pkg. - 5 Cards 1 Pc. per Card	OEM Bulk Pkg. 50 Pcs.	Weight Pounds
40-1/4	1631 DP5 CHR	1631 005 CHR	1-3/8
46-3/4	1631 DP6 CHR	1631 006 CHR	1-1/2
51-3/4	1631 DP7 CHR	1631 007 CHR	1-5/8

O.D. Base 2-1/4", Screw Size #8.

Fig. 1660

Vertical Height Inches	Display Pkg. - 5 Cards 1 Pc. per Card	OEM Bulk Pkg. 50 Pcs.	Weight Pounds
40-5/8	1660 DP5 CHR	1660 005 CHR	1-3/8
46-5/8	1660 DP6 CHR	1660 006 CHR	1-1/2
51-5/8	1660 DP7 CHR	1660 007 CHR	1-5/8

Base Length 3-1/2", Width 1-1/2", Screw Size #8.

Spare Bulbs (2 per card), Cat. No. 337 012 DP. Spare Globe, Cat. No. 201 DP WHT.

Spare Bases with Socket Assembly for Fig. 1631, Cat. No. 1045 P00 DP.

Spare Bases with Socket Assembly for Fig. 1660, Cat. No. 1047 P00 DP.

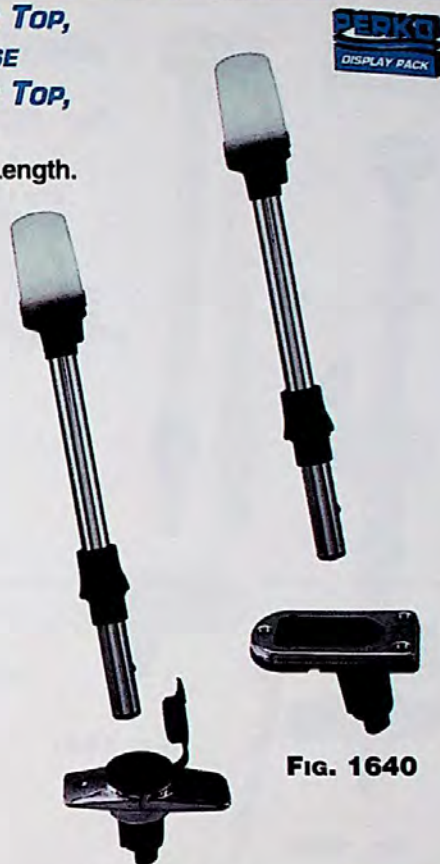

Fig. 1430

Fig. 1640

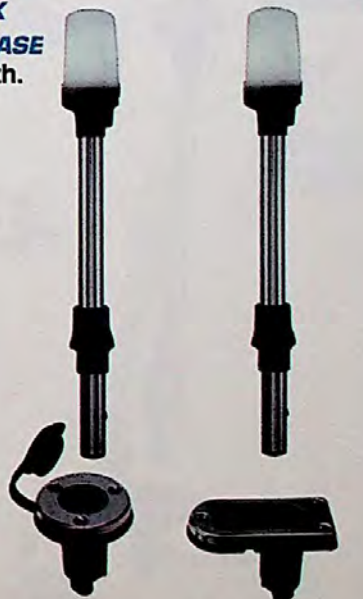

Fig. 1631

Fig. 1660

WHITE ALL-ROUND LIGHTS

**STOW-A-WAY PLUG-IN TYPE - COMPLETE WITH 12 VOLT BULB
3/4 INCH DIAMETER ANODIZED TUBES WITH LOCKING COLLARS,
WATER RESISTANT SLIDE COVERS & WATER PROOF COVERS FOR BASES**

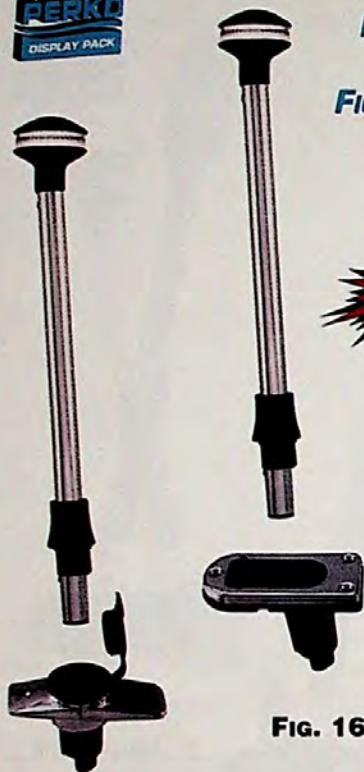

Fig. 1431

"REDUCED GLARE" DESIGN
**FIG. 1431 - CLEAR FLUTED GLOBE, BLACK PLASTIC TOP, WITH
BLACK PLASTIC AND CHROME PLATED BRASS BASE**
**FIG. 1641 - CLEAR FLUTED GLOBE, BLACK PLASTIC TOP, CHROME
PLATED ZINC WITH BLACK PLASTIC INSERT**

For Use on Power Driven Vessels Under 20 Meters (65.6 ft.) in Length.
2 MILE VISIBILITY - POLES HAVE 5° RAKE



chromalex®

ORDERING INFORMATION

Fig. 1431

Vertical Height Inches	Display Pkg. - 5 Cards 1 Pc. per Card	OEM Bulk Pkg. 50 Pcs.	Weight Pounds
36	1431 DP4 CHR	1431 004 CHR	1-1/4
42	1431 DP5 CHR	1431 005 CHR	1-3/8
48	1431 DP6 CHR	1431 006 CHR	1-1/2
54	1431 DP7 CHR	1431 007 CHR	1-5/8

Base Length 3-3/4", Width 1-3/4", Screw Size #8

Fig. 1641

36	1641 DP4 CHR	1641 004 CHR	1-1/4
42	1641 DP5 CHR	1641 005 CHR	1-3/8
48	1641 DP6 CHR	1641 006 CHR	1-1/2
54	1641 DP7 CHR	1641 007 CHR	1-5/8

Base Length 3-1/2", Width 1-1/2", Screw Size #8.

Spare Bulbs (2 per card), Cat. No. 338 DP2 CLR. Spare Lens Assembly, Cat. No. 238 DP BLK.
Spare Bases with Socket Assembly for Fig. 1431, Cat. No. 1060 PB0 DP.
Spare Bases with Socket Assembly for Fig. 1641, Cat. No. 1046 P00 DP.



Fig. 1621

"REDUCED GLARE" DESIGN
**FIG. 1621 - CLEAR FLUTED GLOBE, BLACK PLASTIC TOP, WITH BLACK
PLASTIC AND CHROME PLATED BRASS BASE**

For Use on Power Driven Vessels Under 20 Meters (65.6 ft.) in Length.
2 MILE VISIBILITY - POLE HAS 5° RAKE



chromalex®

ORDERING INFORMATION

Fig. 1621

Vertical Height Inches	Display Pkg. - 5 Cards 1 Pc. per Card	OEM Bulk Pkg. 50 Pcs.	Weight Pounds
36	1621 DP4 CHR	1621 004 CHR	1-3/8
42	1621 DP5 CHR	1621 005 CHR	1-3/8
48	1621 DP6 CHR	1621 006 CHR	1-1/2
54	1621 DP7 CHR	1621 007 CHR	1-5/8

Base Length 3-1/2", Width 1-1/2", Screw Size #8.

Spare Bulbs (2 per card), Cat. No. 338 DP2 CLR. Spare Lens Assembly, Cat. No. 238 DP BLK.
Spare Bases with Socket Assembly for Fig. 1621, Cat. No. 1048 P00 DP.

WHITE ALL-ROUND LIGHTS

**STOW-A-WAY PLUG-IN TYPE - COMPLETE WITH 12 VOLT BULB
3/4 INCH DIAMETER ANODIZED TUBES WITH LOCKING COLLARS,
WATER RESISTANT SLIDE COVERS & WATER PROOF COVERS FOR BASES**

"REDUCED GLARE" DESIGN

FIG. 1632 - CLEAR FLUTED GLOBE, BLACK PLASTIC TOP, WITH BLACK PLASTIC AND CHROME PLATED BRASS BASE

For Use on Power Driven Vessels Under 20 Meters (65.6 ft.) in Length.

2 MILE VISIBILITY

chromalex®

ORDERING INFORMATION

Fig. 1632

Vertical Height Inches	Display Pkg. - 5 Cards 1 Pc. per Card	OEM Bulk Pkg. 50 Pcs.	Weight Pounds
36	1632 DP4 CHR	1632 004 CHR	1-3/8
42	1632 DP5 CHR	1632 005 CHR	1-3/8
48	1632 DP6 CHR	1632 006 CHR	1-1/2
54	1632 DP7 CHR	1632 007 CHR	1-5/8

O.D. Base 2-1/4", Screw Size #8.

Spare Bulbs (2 per card), Cat. No. 338 DP2 CLR. Spare Lens Assembly, Cat. No. 238 DP BLK.
Spare Bases with Socket Assembly for Fig. 1632, Cat. No. 1045 P00 DP.

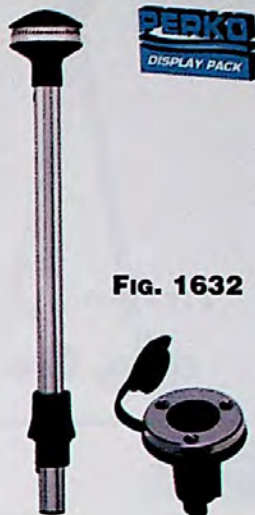

Fig. 1632

FIG. 1330 - CLEAR FRESNEL GLOBE, BLACK PLASTIC TOP, CHROME PLATED ZINC BASE

For Use on Power Driven Vessels Under 20 Meters (65.6 ft.) in Length.

2 MILE VISIBILITY - POLE HAS 16° RAKE.

chromalex®

ORDERING INFORMATION

Vertical Height Inches	Display Pkg. - 5 Cards 1 Pc. per Card	OEM Bulk Pkg. 50 Pcs.	Weight Pounds
20-1/2	1330 DP2 CHR	1330 002 CHR	1
26-5/8	1330 DP3 CHR	1330 003 CHR	1-1/8
32-1/2	1330 DP4 CHR	1330 004 CHR	1-1/4

Base Length 3-3/4", Width 1-5/8", Screw Size #8.

Spare Bulbs (2 per card), Cat. No. 337 011 DP.

Spare Globe, Cat. No. 248 DP CLR.

Spare Base with Socket Assembly, Cat. No. 1059 P00 DP.



Fig. 1330

FIG. 1630 - WHITE TRANSLUCENT GLOBE, BLACK PLASTIC TOP, CHROME PLATED ZINC BASE

For Use on Sail or Power Driven Vessels Under 20 Meters (65.6 ft.) in Length.

2 MILE VISIBILITY - POLE HAS 16° RAKE.

chromalex®

ORDERING INFORMATION

Vertical Height Inches	Display Pkg. - 5 Cards 1 Pc. per Card	OEM Bulk Pkg. 50 Pcs.	Weight Pounds
20-3/4	1630 DP2 CHR	1630 002 CHR	1
26-7/8	1630 DP3 CHR	1630 003 CHR	1-1/8
32-3/4	1630 DP4 CHR	1630 004 CHR	1-1/4
40	1630 DP5 CHR	1630 005 CHR	1-3/8
45-1/2	1630 DP6 CHR	1630 006 CHR	1-1/2
50-1/2	1630 DP7 CHR	1630 007 CHR	1-5/8

Base Length 3-3/4", Width 1-5/8", Screw Size #8.

Spare Bulbs (2 per card), Cat. No. 337 012 DP.

Spare Globe, Cat. No. 201 DP WHT.

Spare Base with Socket Assembly, Cat. No. 1059 P00 DP.



Fig. 1630

WHITE ALL-ROUND LIGHTS

COMPLETE WITH 12 VOLT BULBS, 3/4 INCH DIAMETER ANODIZED TUBES.



Fig. 1209

FIG. 1209 - CLEAR FRESNEL GLOBE, CHROME PLATED BRASS TOP AND BASE WITH WATERPROOF CAP AND RETAINER

For Use on Power Driven Vessels Under 20 Meters (65.6 ft.) in Length.
2 MILE VISIBILITY - POLE HAS 16° RAKE, STOW-A-WAY PLUG-IN TYPE

ORDERING INFORMATION

Vertical Height Inches	Display Pkg. - 5 Cards 1 Pc. per Card	OEM Bulk Pkg. 50 Pcs.	Weight Pounds
21-3/8	1209 DP2 CHR	1209 002 CHR	1
28-3/8	1209 DP3 CHR	1209 003 CHR	1-1/4
34	1209 DP4 CHR	1209 004 CHR	1-1/2

Base Length 3-3/8", Width 2-1/4", Screw Size #8.

Spare Bulbs (2 per card), Cat. No. 337 011 DP.

Spare Globe, Cat. No. 248 DP CLR.

Spare Base with Socket Assembly, Cat. No. 1209 DP 99A.

Spare Bulb Socket, Cat. No. 24 DP2.

Spare Cap for Base, Cat. No. 125 DP BLK.



Fig. 1134



Fig. 1137

FIG. 1134 - WHITE TRANSLUCENT GLOBE, HORIZONTAL MOUNT, FOLD-DOWN ADJUSTABLE ANGLE

FIG. 1137 - WHITE TRANSLUCENT GLOBE, VERTICAL MOUNT, FOLD-DOWN ADJUSTABLE ANGLE

For Use on Sail or Power Driven Vessels Under 20 Meters (65.6 ft.) in Length.
2 MILE VISIBILITY

CHROME PLATED ZINC BASES

PLASTIC ADAPTERS FOR "V" OR FLAT MOUNT & 12 VOLT BULB INCLUDED

chromalex®

ORDERING INFORMATION

Vertical Height Inches	Dimensions Base Inches	Display Pkg. - 5 Cards 1 Pc. per Card	OEM Bulk Pkg. 50 Pcs.	Screw Size	Weight Ounces
13-5/8	2 x 1-1/2	1134 DP CHR	1134 000 CHR	8	13
13-5/8	2-1/4 x 5/8	1137 DP CHR	1137 000 CHR	8	13

Spare Bulb (2 per card), Cat. No. 337 012 DP.

Spare Knob, Cat. No. 1144 A00 BLK.

Spare Globe, Cat. No. 201 DP WHT.

Spare Bracket with Knob and End Plug for Fig. No. 1134, Cat. No. 1052 DP CHR.

Spare Bracket with Knob and End Plug for Fig. No. 1137, Cat. No. 1054 DP CHR.



Fig. 1634



Fig. 1637

"REDUCED GLARE" DESIGN

FIG. 1634 - BLACK PLASTIC TOP WITH CLEAR FLUTED GLOBE, HORIZONTAL MOUNT, FOLD-DOWN ADJUSTABLE ANGLE

FIG. 1637 - BLACK PLASTIC TOP WITH CLEAR FLUTED GLOBE, VERTICAL MOUNT, FOLD-DOWN ADJUSTABLE ANGLE

For Use on Power Driven Vessels Under 20 Meters (65.6 ft.) in Length.

2 MILE VISIBILITY

CHROME PLATED ZINC BASES

PLASTIC ADAPTERS FOR "V" OR FLAT MOUNT & 12 VOLT BULB INCLUDED

chromalex®

ORDERING INFORMATION

Vertical Height Inches	Dimensions Base Inches	Display Pkg. - 5 Cards 1 Pc. per Card	OEM Bulk Pkg. 50 Pcs.	Screw Size	Weight Ounces
14-1/2	2 x 1-1/2	1634 DP CHR	1634 000 CHR	8	13
14-1/2	2-1/4 x 5/8	1637 DP CHR	1637 000 CHR	8	13

Spare Bulb (2 per card), Cat. No. 338 DP2 CLR.

Spare Knob, Cat. No. 1144 A00 BLK.

Spare Lens Assembly, Cat. No. 238 DP BLK.

Spare Bracket with Knob and End Plug for Fig. No. 1634, Cat. No. 1052 DP CHR.

Spare Bracket with Knob and End Plug for Fig. No. 1637, Cat. No. 1054 DP CHR.

WHITE ALL-ROUND LIGHTS

**TELESCOPING TYPE - COMPLETE WITH 12 VOLT BULB
3/4 INCH DIAMETER ANODIZED TUBES WITH LOCKING COLLARS.**

**FIG. 1311 - CLEAR FRESNEL GLOBE, BLACK PLASTIC TOP,
CHROME PLATED ZINC BASE - TELESCOPING TYPE**

For Use on Power Driven Vessels Under 20 Meters (65.6 ft.) in Length.
2 MILE VISIBILITY - POLE HAS 16° RAKE

chromalex®

ORDERING INFORMATION

Vertical Height Inches	Display Pkg. - 5 Cards 1 Pc. per Card	OEM Bulk Pkg. 50 Pcs.	Weight Pounds
20-1/2	1311 DP2 CHR	1311 002 CHR	7/8
26-5/8	1311 DP3 CHR	1311 003 CHR	1
32-1/2	1311 DP4 CHR	1311 004 CHR	1-1/8

Base Length 3-3/4", Width 1-5/8", Screw Size #8.

Spare Bulb (2 per card), Cat. No. 337 011 DP.

Spare Globe, Cat. No. 248 DP CLR.

Spare Base, Cat No. 1059 T00 DP.



FIG. 1311

**FIG. 1611 - WHITE TRANSLUCENT GLOBE, BLACK PLASTIC TOP,
CHROME PLATED ZINC BASE - TELESCOPING TYPE**

For Use on Power Driven Vessels Under 20 Meters (65.6 ft.) in Length.
2 MILE VISIBILITY - POLE HAS 16° RAKE

chromalex®

ORDERING INFORMATION

Vertical Height Inches	Display Pkg. - 5 Cards 1 Pc. per Card	OEM Bulk Pkg. 50 Pcs.	Weight Pounds
20-3/4	1611 DP2 CHR	1611 002 CHR	7/8
26-7/8	1611 DP3 CHR	1611 003 CHR	1
32-3/4	1611 DP4 CHR	1611 004 CHR	1-1/8

Base Length 3-3/4", Width 1-5/8", Screw Size #8.

Spare Bulb (2 per card), Cat. No. 337 012 DP.

Spare Globe, Cat. No. 201 DP WHT.

Spare Base, Cat No. 1059 T00 DP.



FIG. 1611

**FIG. 455 - CLEAR FRESNEL GLOBE, FIXED MOUNT
BLACK PLASTIC BASE**

For Use on Power Driven Vessels Under 20 Meters (65.6 ft.) in Length.

2 MILE VISIBILITY

chromalex®

ORDERING INFORMATION

Vertical Height Inches	O.D. Base Inches	Display Pkg. - 5 Cards 1 Pc. per Card	OEM Bulk Pkg. 50 Pcs.	Screw Size	Weight Ounces
4-1/2	2-1/16	455 DP1 CHR	455 001 CHR	8	12
11	2-1/16	455 DP2 CHR	455 002 CHR	8	16



FIG. 455

WHITE ALL-ROUND LIGHTS, POLE STORAGE CLIPS & GLARE SHIELD

BLACK PLASTIC TOPS AND BASES, 3/4 INCH ANODIZED ALUMINUM TUBES



FIG. 1604 - "REDUCED GLARE" DESIGN, CLEAR FLUTED GLOBE, FIXED MOUNT, 12 VOLT BULB

For Use on Power Driven Vessels Under 20 Meters (65.6 ft.) in Length.
2 MILE VISIBILITY

chromalex®

ORDERING INFORMATION

Vertical Height Inches	Dimensions Base Inches	Display Pkg. - 5 Cards 1 Pc. per Card	OEM Bulk Pkg. 50 Pcs.	Screw Size	Weight Ounces
6-7/8	1 x 2-5/8	1604 DP CHR	1604 000 CHR	8	8

Spare Bulb (2 per card), Cat. No. 338 DP2 CLR. Spare Lens Assembly, Cat. No. 238 DP BLK.

FIG. 1604



FIG. 120 SWB - WHITE TRANSLUCENT GLOBE, FIXED MOUNT, 12 VOLT BULB

FIG. 170 SWB - WHITE TRANSLUCENT GLOBE, FIXED MOUNT, 24 VOLT BULB

FIG. 1301 - WHITE TRANSLUCENT GLOBE, FIXED MOUNT, 12 VOLT BULB

For Use on Sail or Power Driven Vessels Under 20 Meters (65.6 ft.) in Length.
2 MILE VISIBILITY

chromalex®

ORDERING INFORMATION

Vertical Height Inches	Dimensions Base Inches	Display Pkg. - 5 Cards 1 Pc. per Card	OEM Bulk Pkg. 50 Pcs.	Screw Size	Weight Ounces
3-3/4	1 x 2-5/8	120 SWB DP1	120 SWB 12V	8	7
3-3/4	1 x 2-5/8	170 SWB DP2	170 SWB 24V	8	7
7-1/8	1 x 2-5/8	1301 DP CHR	1301 000 CHR	8	8

Spare 12 Volt Bulbs (2 per card), Cat. No. 337 012 DP. Spare Globe, Cat. No. 201 DP WHT.
For Fig. 170 SWB, Spare 24 Volt Bulb, Cat. No. 337 014 DP.



FIG. 1301



Figs. 120 SWB & 170 SWB



FIG. 477

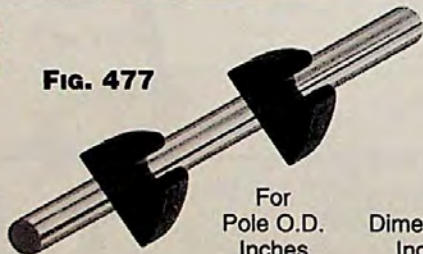

FIG. 477 - POLE STORAGE CLIPS SOFT BLACK PLASTIC. U.V. STABILIZED FITS 3/4 INCH DIAMETER TUBING

ORDERING INFORMATION



For Pole O.D. Inches	Dimensions Inches	Display Pkg. - 10 Cards 1 Pair per Card	OEM Bulk Pkg. 50 Pair	Screw Size	Weight per Pair Ounces
3/4	3/4 x 2-1/4 x 1-5/8	477 DP BLK	477 000 BLK	10 P.H.	3



GLARE SHIELD - FIG. 1192

Black Plastic

For 3/4 Inch O.D. Tubing, Can Be Installed Without Removing Light

ORDERING INFORMATION

Dimensions Inches	Display Pkg. - 5 Cards 1 Pc. per Card	OEM Bulk Pkg. 25 Pcs.	Weight Ounces
6 x 4-5/16	1192 DP BLK	1192 000 BLK	3



FIG. 1192

ALL-ROUND LIGHTS

FIG. 108 - BLACK PLASTIC WITH FESTOON TYPE ELECTRICAL SOCKET

For Use on Power Driven Vessels Under 20 Meters (65.6 ft.) in Length.
2 MILE VISIBILITY

For 12, 24 or 32 Volts. Bulb Not Included.

ORDERING INFORMATION

Description	Height Overall Inches	O.D. Base Inches	Tapped Pipe Size Inches	Black Plastic Standard Pkg. - 1 Pc.	Screw Size	Weight Pounds
White All-Round	6	3-1/8	1/2*	108 000 BLK**	10	2
Red All-Round	6	3-1/8	1/2*	108 R00 BLK	10	2
Green All-Round	6	3-1/8	1/2*	108 G00 BLK	10	2

*Base Removable for Surface Mounting.

**These Lights Are Supplied with a Gray Tinted Globe.



FIG. 108

FIGS. 112 & 309 - CAST BRONZE, PLAIN OR CHROME PLATED MEDIUM SCREW BASE TYPE ELECTRICAL SOCKET

For Use on Power Driven Vessels Under 20 Meters (65.6 ft.) in Length.
2 MILE VISIBILITY

For 12 or 32 Volts. Bulb Not Included.

ORDERING INFORMATION

Description	Height Overall Inches	O.D. Base Inches	Tapped Pipe Size Inches	Plain Bronze Standard Pkg. - 1 Pc.	Screw Size	Weight Pounds
White All-Round	8-3/4	3-1/8	---	112 B00 PLB	8	2-1/2
Red All-Round	8-3/4	3-1/8	---	112 RB0 PLB	8	2-1/2
Green All-Round	8-3/4	3-1/8	---	112 GB0 PLB	8	2-1/2
Yellow All-Round	8-3/4	3-1/8	---	112 MB0 PLB	8	2-1/2
White All-Round	6-1/2	-----	1/2	309 B00 PLB	--	2-1/4
Red All-Round	6-1/2	-----	1/2	309 RB0 PLB	--	2-1/4
Green All-Round	6-1/2	-----	1/2	309 GB0 PLB	--	2-1/4
Yellow All-Round	6-1/2	-----	1/2	309 MB0 PLB	--	2-1/4

SPARE PARTS ORDERING INFORMATION FOR FIGS. 108, 112 & 309

Spare Globes:

White, Cat. No. 106 000 WHT.
 Gray, Cat. No. 106 000 GRY.
 Red, Cat. No. 106 000 RED.
 Green, Cat. No. 106 000 GRN.
 Yellow, Cat. No. 106 000 YLW.

Required Bulbs:

12 Volts for Fig. 108 (2 Per card), Cat. No. 70 DP1 CLR.
 12 Volts for White and Yellow Figs. 112 and 309, Cat. No. 340 005 FRD.
 12 Volts for Red and Green Figs. 112 and 309, Cat. No. 340 006 FRD.
 24 Volts for Fig. 108 (2 per Card), Cat. No. 67 DP2 CLR.
 32 Volts for Fig. 108 (2 per Card), Cat. No. 70 DP2 CLR.
 32 Volts for White and Yellow Figs. 112 and 309, Cat. No. 340 011 FRD.
 32 Volts for Red and Green Figs. 112 and 309, Cat. No. 340 012 FRD.

Spare Medium Screw Base Socket, Cat. No. 226.

Spare Base and Gasket for Fig. 108, Cat. No. 222 DP BLK.



FIG. 112



FIG. 309

FIGS. 362 & 371 - FROSTED GLOBE, CAST BRONZE, PLAIN OR CHROME PLATED

For Use on Sail or Power Driven Vessels Under 20 Meters (65.6 ft.) in Length.
2 MILE VISIBILITY

Double Contact Socket, Complete with 12 Volt Bulb.

ORDERING INFORMATION

Vertical Height Inches	O.D. Base Inches	Plain Bronze Display Pkg.- 5 Cards 1 Pc. per Card	Chrome Plated Bronze Display Pkg.- 5 Cards 1 Pc. per Card	Screw Size	Tapped Pipe Size Inches	Weight Ounces
2-3/8	-----	362 DP PLB	362 DP CHR	-----	1/2	8
1-5/8	2-1/2	371 DP PLB	371 DP CHR	8 F.H.	-----	10

Spare Bulbs (2 per card), Cat. No. 337 011 DP
 Spare Socket, Cat. No. 24 DP1.

Spare Globe, Cat. No. 248 000 FRD.



FIG. 362



FIG. 371

UNIVERSAL REPLACEMENT WHITE ALL-ROUND LIGHTS

REPLACEMENT STOW-A-WAY PLUG-IN TYPE

For Use on Sail or Power Driven Vessels Under 20 Meters (65.6 ft.) in Length.

2 MILE VISIBILITY

**WHITE TRANSLUCENT GLOBE, BLACK PLASTIC TOP, COMPLETE WITH 12 VOLT BULB
3/4 INCH DIAMETER ANODIZED ALUMINUM TUBES, BASES NOT INCLUDED.**

FIG. 1400 - UNIVERSAL REPLACEMENT

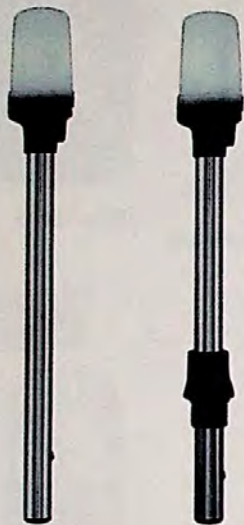

Fig. 1400 Fig. 1600



ORDERING INFORMATION

Approx. Length Inches	Display Pkg. 1 Pc. per Card	Cards Per Package	Weight Pounds
24	1400 DP2 CHR	10	1/2
30	1400 DP3 CHR	10	5/8
36	1400 DP4 CHR	10	1-1/2
42	1400 DP5 CHR	10	1-3/4
48	1400 DP6 CHR	5	2
54	1400 DP7 CHR	5	2-1/4

FIG. 1600 - REPLACEMENT PERKO LIGHTS WITH LOCKING COLLAR

ORDERING INFORMATION

Approx. Length Inches	Display Pkg. 1 Pc. per Card	Cards Per Package	Weight Pounds
24	1600 DP2 CHR	10	1/2
30	1600 DP3 CHR	10	5/8
36	1600 DP4 CHR	10	1-1/2
42	1600 DP5 CHR	10	1-3/4
48	1600 DP6 CHR	5	2
54	1600 DP7 CHR	5	2-1/4



"REDUCED GLARE" REPLACEMENT ALL-ROUND LIGHTS

FIG. 1440 - FITS PERKO STYLE VERTICAL BASES.

FIG. 1445 - FITS PERKO STYLE BASES WITH 5° ANGLE

For Use on Power Driven Vessels Under 20 Meters (65.6 ft.) in Length.

2 MILE VISIBILITY

**CLEAR FLUTED GLOBE, BLACK PLASTIC TOP, COMPLETE WITH 12 VOLT BULB
3/4 INCH DIAMETER ANODIZED ALUMINUM TUBES WITH LOCKING COLLAR,
BASES NOT INCLUDED.**



Fig. 1440 Fig. 1445



ORDERING INFORMATION

Approx. Length Inches	Display Pkg. 1 Pc. per Card	Cards Per Package	Weight Pounds
24	1440 DP2 CHR	10	1/2
30	1440 DP3 CHR	10	5/8
36	1440 DP4 CHR	10	1-1/2
42	1440 DP5 CHR	10	1-3/4
48	1440 DP6 CHR	5	2
54	1440 DP7 CHR	5	2-1/4
24	1445 DP2 CHR	10	1/2
30	1445 DP3 CHR	10	5/8
36	1445 DP4 CHR	10	1-1/2
42	1445 DP5 CHR	10	1-3/4
48	1445 DP6 CHR	5	2
54	1445 DP7 CHR	5	2-1/4

REPLACEMENT POLE LIGHTS

REPLACEMENT STOW-A-WAY PLUG-IN TYPE
3/4 INCH DIAMETER ANODIZED ALUMINUM TUBES, BASES NOT INCLUDED.



FOR FIG. 1612
 BLACK PLASTIC TOP

1 MILE VISIBILITY

ORDERING INFORMATION

For Fig. Number	Vertical Height Inches	Display Pkg. - 5 Cards 1 Pc. per Card	Weight Ounces
1612	9-3/4	1612 DP 99A	7

Figs. 1211, 1212, 1296 & 1612
 For Use on Sail or Power Driven Vessels Under 12 Meters (39.4 ft.) in Length.

Figs. 1123, 1124 & 1125
 For Use on Sail or Power Driven Vessels Under 20 Meters (65.6 ft.) in Length.

Figs. 1273, 1274 & 1275
 For Use on Power Driven Vessels Under 12 Meters (39.4 ft.) in Length.

Figs. 1209, 1330, 1421, 1422, & 1423
 For Use on Power Driven Vessels Under 20 Meters (65.6 ft.) in Length.



REMOVABLE BI-COLOR LIGHT WITH UTILITY LIGHT
 FOR FIGS. 1211 & 1296
 BLACK PLASTIC AND CHROME PLATED ZINC TOP WITH UTILITY LIGHT.

FOR FIG. 1212
 BLACK PLASTIC AND CHROME PLATED ZINC TOP WITH UTILITY LIGHT, POLE HAS A 5° ANGLE.
 1 MILE VISIBILITY

ORDERING INFORMATION

For Fig. Number	Vertical Height Inches	Display Pkg. - 5 Cards 1 Pc. per Card	Weight Ounces
1211/1296	10	1211 DP 99A	8
1212	10-1/4	1212 DP 99A	8

REMOVABLE BI-COLOR LIGHT WITH UTILITY LIGHT
 FOR FIGS. 1421 & 1423
 BLACK PLASTIC TOP WITH UTILITY LIGHT.

FIG. 1422
 BLACK PLASTIC TOP WITH UTILITY LIGHT.
 POLE HAS A 5° ANGLE.
 2 MILE VISIBILITY.

ORDERING INFORMATION

For Fig. Number	Vertical Height Inches	Display Pkg. - 5 Cards 1 Pc. per Card	Weight Ounces
1421/1423	10	1421 DP 99A	8
1422	10-1/4	1422 DP 99A	8



Fig. 1421/1423

Fig. 1422



WINDSHIELD MOUNT
 FOR FIG. 1123 - HORIZONTAL MOUNT
 FOR FIG. 1124 - VERTICAL MOUNT

3 MILE VISIBILITY

ORDERING INFORMATION

For Fig. Number	Vertical Height Inches	Display Pkg. - 5 Cards 1 Pc. per Card	Weight Pounds
1123/1124	11-1/2	1123 DP1 99A	1
1123/1124	20-3/4	1123 DP2 99A	1-1/8

Fig. 1123

"REDUCED GLARE" DESIGN
 WINDSHIELD MOUNT
 FOR FIG. 1273 - HORIZONTAL MOUNT
 FOR FIG. 1274 - VERTICAL MOUNT

2 MILE VISIBILITY

ORDERING INFORMATION

For Fig. Number	Vertical Height Inches	Display Pkg. - 5 Cards 1 Pc. per Card	Weight Pounds
1273/1274	11-3/4	1273 DP1 99A	1
1273/1274	21	1273 DP2 99A	1-1/8



Fig. 1273



FOR FIG. 1125 - DECK MOUNT

3 MILE VISIBILITY - POLE HAS 16° RAKE.

ORDERING INFORMATION

For Fig. Number	Vertical Height Inches	Display Pkg. - 5 Cards 1 Pc. per Card	Weight Pounds
1125	33-5/8	1125 DP4 99A	1-1/2

Fig. 1125

"REDUCED GLARE" DESIGN
 FOR FIG. 1275 - DECK MOUNT

2 MILE VISIBILITY - POLE HAS 16° RAKE.

ORDERING INFORMATION

For Fig. Number	Vertical Height Inches	Display Pkg. - 5 Cards 1 Pc. per Card	Weight Pounds
1275	33-3/4	1275 DP4 99A	1-1/2

Fig. 1275



FOR FIG. 1330 - DECK MOUNT

2 MILE VISIBILITY - POLE HAS 16° RAKE.

ORDERING INFORMATION

For Fig. Number	Vertical Height Inches	Display Pkg. - 5 Cards 1 Pc. per Card	Weight Pounds
1330	20-1/2	1330 DP2 99A	1
1330	26-5/8	1330 DP3 99A	1-1/8
1330	32-1/2	1330 DP4 99A	1-1/4

Fig. 1330

FOR FIG. 1209 - DECK MOUNT

2 MILE VISIBILITY - POLE HAS 16° RAKE.

ORDERING INFORMATION

For Fig. Number	Vertical Height Inches	Display Pkg. - 5 Cards 1 Pc. per Card	Weight Pounds
1209	21-3/8	1209 DP2 99A	1
1209	28-3/8	1209 DP3 99A	1-1/4
1209	34	1209 DP4 99A	1-1/2

Fig. 1209

NAVIGATION LIGHTS FOR VESSELS UNDER 20 METERS

NAVIGATION LIGHT VERTICAL HEIGHTS

NOTE: Vertical Height "H" is Measured from the Center of the Bulb Filament to the Mounting Surface and May be Used as a Generalized Guide for the Selection of Lights in Accordance with the Vertical Light Separation Requirements of Navigation Regulations.

Bi-COLOR LIGHTS

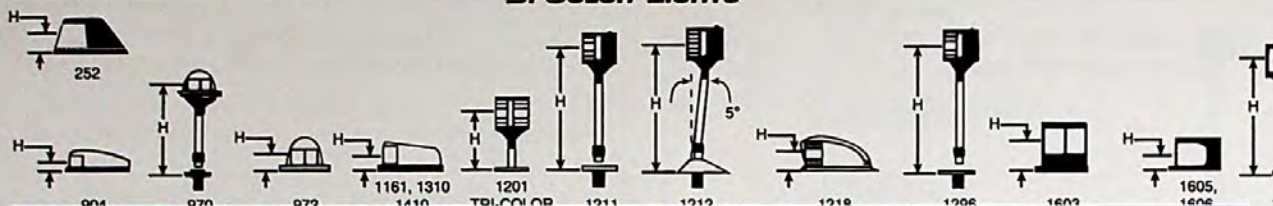

Bi-Color Lights															
FIG.	252	904	972	1161	1201	1211	1212	1218	1296	1310	1410	1603	1605	1606	1612
H	7/8	7/8	7/8	1	3-1/4	10	10-1/4	1-5/8	10	1	1	1-1/8	5/8	5/8	9-3/4

WHITE ALL-ROUND LIGHTS



COMBINATION MASTHEAD AND WHITE ALL-ROUND LIGHTS

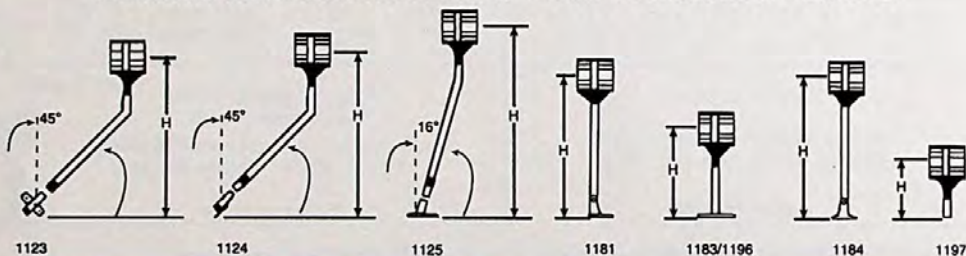

DIMENSIONS								
SIZE		1	2	3	4	5	6	7
FIG.	H	H	H	H	H	H	H	H
WHITE ALL-ROUND LIGHTS								
120 SWB	3-3/4							
170 SWB	3-3/4							
362	2-3/8							
371	1-5/8							
455		4-1/2	11					
1134	13-5/8							
1137	13-5/8							
1209			21-3/8	28-3/8	34			
1301	7-1/8							
1311			20-1/2	26-5/8	32-1/2			
1330			20-1/2	26-5/8	32-1/2			
1411			21	27-1/4	33-1/2			
1430			21	27-1/4	33-1/2	40-3/4	46-3/4	51-3/4
1611			20-3/4	26-7/8	32-3/4			
1630			20-3/4	26-7/8	32-3/4	40	45-1/2	50-1/2
1631						40-1/4	46-3/4	51-3/4
1640			20-5/8	27-1/8	33-1/4	40-1/2	46-1/2	51-1/2
1660						40-5/8	46-5/8	51-5/8
COMBINATION MASTHEAD AND WHITE ALL-ROUND LIGHTS								
1123			11-1/2	20-3/4				
1124			11-1/2	20-3/4				
1125					33-5/8			
1181	12-5/8							
1183	3-1/4							
1184	12-5/8							
1196		5-1/4	11-1/4					
1197	4							

SIDE LIGHTS

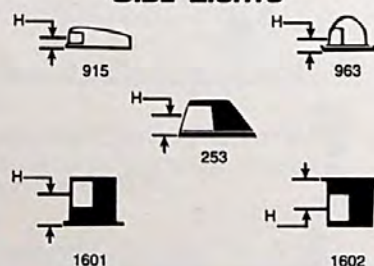

SIDE LIGHTS					
FIG.	253	915	963	1601	1602
H	1-5/8	7/8	7/8	1-1/8	1-1/8

MASTHEAD LIGHTS



MASTHEAD LIGHTS		
FIG.	964	1178
H	7/8	3-1/4

NAVIGATION LIGHT VERTICAL HEIGHTS

NOTE: Vertical Height "H" is Measured from the Center of the Bulb Filament to the Mounting Surface and May be Used as a Generalized Guide for the Selection of Lights in Accordance with the Vertical Light Separation Requirements of Navigation Regulations.

"REDUCED GLARE" DESIGN BI-COLOR LIGHTS



"Reduced Glare" Design Bi-Color Lights			
FIG.	1421	1422	1423
H	9-1/2	9-3/4	9-1/2

"REDUCED GLARE" DESIGN WHITE ALL-ROUND LIGHTS



"REDUCED GLARE" DESIGN COMBINATION MASTHEAD AND WHITE ALL-ROUND LIGHTS



DIMENSIONS								
SIZE		1	2	3	4	5	6	7
FIG.	H	H	H	H	H	H	H	H
"REDUCED GLARE" DESIGN WHITE ALL-ROUND LIGHTS								
1431					32-7/8	40-3/4	46-1/2	51-5/8
1604	6-3/4				33	40-1/2	46-1/2	51-5/8
1621								
1634	13-5/8							
1632					33	40-1/2	46-1/4	51-3/8
1637	13-1/2							
1641					32-7/8	40-1/2	46-1/8	51-1/4
"REDUCED GLARE" DESIGN COMBINATION MASTHEAD AND WHITE ALL-ROUND LIGHTS								
1236		4-1/2						
1273			10-5/8	21-1/4				
1274			10-1/2	21-1/4				
1275					33			
1281	12-1/2							
1283	2-3/8							
1284	12-1/2							

NAVIGATION LIGHTS

**FOR USE ON SAIL OR POWER DRIVEN VESSELS AS SPECIFIED BELOW.
BLACK PLASTIC. COMPLETE WITH 12 VOLT OR 24 VOLT BULB.**



Fig.	Height Overall Inches	Projection Overall Inches	Width Inches	Screw Size	Weight Ounces
120 & 170 BMD	7	4-3/4	4-1/8	10	18-1/2
All Others	3-5/8	2-1/2	4-1/8	10	5

FIG. 120 - FOR USE ON SAIL OR POWER DRIVEN VESSELS UNDER 12 METERS (39.4 FT.) IN LENGTH. (12 VOLT ONLY)
ORDERING INFORMATION

Description	Visibility Arc	Display Pkg. - 5 Cards 1 Pc. per Card	OEM Bulk Pkg. 10 Pcs.	Visibility Miles
Bi-Color Light	225°	120 BB DP1	120 BB 12V	1
Red Side Light	112-1/2°	120 BP DP1	120 BP 12V	1
Green Side Light	112-1/2°	120 BSD DP1	120 BSD 12V	1
White Masthead Light	225°	120 BM DP1	120 BM 12V	2
White Stern Light	135°	120 BSN DP1	120 BSN 12V	2
Masthead/Deck Spreader Light	225°	120 BMD DP1	120 BMD 12V	2

FIG. 170 - FOR USE ON SAIL OR POWER DRIVEN VESSELS UNDER 20 METERS (65.6 FT.) IN LENGTH. (12 OR 24 VOLT)
ORDERING INFORMATION

Description	Visibility Arc	12 Volt		24 Volt		Visibility Miles
		Display Pkg. - 5 Cards 1 Pc. per Card	OEM Bulk Pkg. 10 Pcs.	Display Pkg. - 5 Cards 1 Pc. per Card	OEM Bulk Pkg. 10 Pcs.	
Bi-Color Light	225°	170 BB DP1	170 BB 12V	170 BB DP2	170 BB 24V	2
Red Side Light	112-1/2°	170 BP DP1	170 BP 12V	170 BP DP2	170 BP 24V	2
Green Side Light	112-1/2°	170 BSD DP1	170 BSD 12V	170 BSD DP2	170 BSD 24V	2
White Masthead Light	225°	170 BM DP1	170 BM 12V	170 BM DP2	170 BM 24V	3
White Stern Light	135°	170 BSN DP1	170 BSN 12V	170 BSN DP2	170 BSN 24V	2
*Mast/Dk Spreader Lt	225°	170 BMD DP1	170 BMD 12V	-----	-----	3

*New Item



FIG. 120 BSD & 170 BSD



FIG. 120 BB & 170 BB



FIG. 120 BP & 170 BP



FIG. 120 BSN & 170 BSN



FIG. 120 BM & 170 BM



FIG. 120 BMD & 170 BMD*

SPARE PARTS ORDERING INFORMATION

Spare Halogen Bulb for Deck Spreader Light, Cat. No. 68 12V 20W. Spare Bulbs (2 per card) for All Other 12 Volt 170's, Cat. No. 69 DP CLR.
Spare Bulbs (2 per card) for 170 BSN (12 Volt), Cat. No. 69 DP CLR. Spare Bulbs (2 per card) for All Other 24 Volt 170's, Cat. No. 67 DP2 CLR.

For Spare Lens and Shield Assembly, Replace the Last Three Digits of the Catalog Number with the Letters "LNS" (e.g., 120 BB LNS, for a Black Shield and Bi-Color Lens).

NAVIGATION LIGHTS FOR VESSELS UNDER 20 METERS

NAVIGATION LIGHTS

**FOR USE ON SAIL OR POWER DRIVEN VESSELS AS SPECIFIED BELOW.
CHROME PLATED BRASS WITH BLACK PLASTIC BASE.
COMPLETE WITH 12 VOLT OR 24 VOLT BULB.**

Fig.	Height Overall Inches	Projection Overall Inches	Width Inches	Screw Size	Weight Ounces
120 SWB	5-1/8*	----	2-1/2	8	4-1/2
170 SWB	5-1/8*	----	2-1/2	8	4-1/2
All Others	3-5/8	2-1/2	4-1/8	10	5



*Vertical Height - 3-3/4 Inches.

FIG. 120 - FOR USE ON SAIL OR POWER DRIVEN VESSELS UNDER 12 METERS (39.4 FT.) IN LENGTH. (12 VOLT ONLY)
ORDERING INFORMATION

Description	Visibility Arc	Display Pkg. - 5 Cards 1 Pc. per Card	OEM Bulk Pkg. 10 Pcs.	Visibility Miles
Bi-Color Light	225°	120 MB DP1	120 MB 12V	1
Red Side Light	112-1/2°	120 MP DP1	120 MP 12V	1
Green Side Light	112-1/2°	120 MSD DP1	120 MSD 12V	1
White Masthead Light	225°	120 MM DP1	120 MM 12V	2
White Stern Light	135°	120 MSN DP1	120 MSN 12V	2
White All-Round Light	360°	120 SWB DP1	120 SWB 12V**	2

FIG. 170 - FOR USE ON SAIL OR POWER DRIVEN VESSELS UNDER 20 METERS (65.6 FT.) IN LENGTH. (12 OR 24 VOLT)
ORDERING INFORMATION

Description	Visibility Arc	12 Volt		24 Volt		Visibility Miles
		Display Pkg. - 5 Cards 1 Pc. per Card	OEM Bulk Pkg. 10 Pcs.	Display Pkg. - 5 Cards 1 Pc. per Card	OEM Bulk Pkg. 10 Pcs.	
Bi-Color Light	225°	170 MB DP1	170 MB 12V	170 MB DP2	170 MB 24V	2
Red Side Light	112-1/2°	170 MP DP1	170 MP 12V	170 MP DP2	170 MP 24V	2
Green Side Light	112-1/2°	170 MSD DP1	170 MSD 12V	170 MSD DP2	170 MSD 24V	2
White Masthead Light	225°	170 MM DP1	170 MM 12V	170 MM DP2	170 MM 24V	3
White Stern Light	135°	170 MSN DP1	170 MSN 12V	170 MSN DP2	170 MSN 24V	2
White All-Round Light	360°	(See 120 SWB Above)	(See 120 SWB Above)	170 SWB DP2	170 SWB 24V**	2

**OEM Bulk Pkg. - 50 pcs.



**Fig. 120 MSD &
170 MSD**



**Fig. 120 MB &
170 MB**



**Fig. 120 MP &
170 MP**



**Fig. 120 MSN &
170 MSN**



**Fig. 120 MM &
170 MM**



**Fig. 120 SWB &
170 SWB**

SPARE PARTS ORDERING INFORMATION

Spare Bulbs (2 per card) for 120 SWB, Cat. No. 337 012 DP.
Spare Bulb for 170 SWB (24 Volt), Cat. No. 337 014 DP.
Spare Bulbs (2 per card) for All Other 120's, Cat. No. 69 DP CLR.
Spare Bulbs (2 per card) for 170 MSN (12 Volt), Cat. No. 69 DP CLR.

Spare Bulbs (2 per card) for 170 MSN (24 Volt), Cat. No. 67 DP1 CLR.
Spare Bulbs (2 per card) for All Other 12 Volt 170's, Cat. No. 70 DP1 CLR.
Spare Bulbs (2 per card) for All Other 24 Volt 170's, Cat. No. 67 DP2 CLR.

For Spare Lens and Shield Assembly, Replace the Last Three Digits of the Catalog Number with the Letters "LNS" (e.g., 120 MM LNS, for a Chrome Plated Brass Shield and Bi-Color Lens).

NAVIGATION LIGHTS

FOR USE ON SAIL OR POWER DRIVEN VESSELS AS SPECIFIED BELOW.

**WHITE PLASTIC WITH BLACK PLASTIC BASE.
COMPLETE WITH 12 VOLT OR 24 VOLT BULB.**



Height Overall Inches	Projection Overall Inches	Width Inches	Screw Size	Weight Ounces
3-5/8	2-1/2	4-1/8	10	5

FIG. 120 - FOR USE ON SAIL OR POWER DRIVEN VESSELS UNDER 12 METERS (39.4 FT.) IN LENGTH. (12 VOLT ONLY)

ORDERING INFORMATION

Description	Visibility Arc	Display Pkg. - 5 Cards 1 Pc. per Card	OEM Bulk Pkg. 10 Pcs.	Visibility Miles
Bi-Color Light	225°	120 WB DP1	120 WB 12V	1
Red Side Light	112-1/2°	120 WP DP1	120 WP 12V	1
Green Side Light	112-1/2°	120 WSD DP1	120 WSD 12V	1
White Masthead Light	225°	120 WM DP1	120 WM 12V	2
White Stern Light	135°	120 WSN DP1	120 WSN 12V	2

FIG. 170 - FOR USE ON SAIL OR POWER DRIVEN VESSELS UNDER 20 METERS (65.6 FT.) IN LENGTH. (12 OR 24 VOLT)

ORDERING INFORMATION

ORDERING INFORMATION

Description	Visibility Arc	12 Volt	12 Volt	24 Volt	24 Volt	Visibility Miles
		Display Pkg. - 5 Cards 1 Pc. per Card	OEM Bulk Pkg. 10 Pcs.	Display Pkg. - 5 Cards 1 Pc. per Card	OEM Bulk Pkg. 10 Pcs.	
Bi-Color Light	225°	170 WB DP1	170 WB 12V	170 WB DP2	170 WB 24V	2
Red Side Light	112-1/2°	170 WP DP1	170 WP 12V	170 WP DP2	170 WP 24V	2
Green Side Light	112-1/2°	170 WSD DP1	170 WSD 12V	170 WSD DP2	170 WSD 24V	2
White Masthead Light	225°	170 WM DP1	170 WM 12V	170 WM DP2	170 WM 24V	3
White Stern Light	135°	170 WSN DP1	170 WSN 12V	170 WSN DP2	170 WSN 24V	2



**Fig. 120 WSD &
170 WSD**



**Fig. 120 WB &
170 WB**

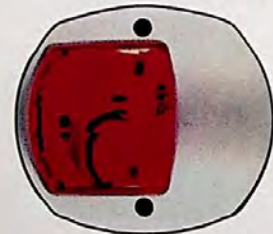

**Fig. 120 WP &
170 WP**



**Fig. 120 WSN &
170 WSN**

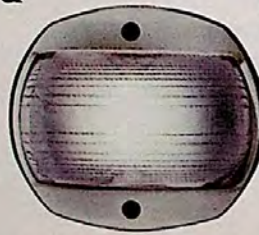

**Fig. 120 WM &
170 WM**

SPARE PARTS ORDERING INFORMATION

Spare Bulbs (2 per card) for All 120's, Cat. No. 69 DP CLR. Spare Bulbs (2 per card) for 170 WSN (24 Volt), Cat. No. 67 DP1 CLR.
Spare Bulbs (2 per card) for 170 WSN (12 Volt), Cat. No. 69 DP CLR. Spare Bulbs (2 per card) for All Other 24 Volt 170's, Cat. No. 67 DP2 CLR.
Spare Bulbs (2 per card) for All Other 12 Volt 170's, Cat. No. 70 DP1 CLR

For Spare Lens and Shield Assembly, Replace the Last Three Digits of the Catalog Number with the Letters "LNS" (e.g., 120 WB LNS, for a White Shield and Bi-Color Lens).

NAVIGATION LIGHTS FOR VESSELS UNDER 20 METERS

NAVIGATION LIGHTS

FOR USE ON SAIL OR POWER DRIVEN VESSELS UNDER 20 METERS (65.6 FT.) IN LENGTH.

TOP MOUNT.

**BLACK PLASTIC WITH STAINLESS STEEL MOUNTING BRACKET.
COMPLETE WITH 12, 24 OR 32 VOLT BULB.**

Height Overall Inches	Projection Inches	Height Lens Inches	Screw Size	Weight Ounces
4-13/16	3-5/16	2-3/4	8	12-1/2



ORDERING INFORMATION - FOR 12 VOLT LIGHTS

Description	Visibility Arc	Display Pkg. - 5 Cards 1 Pc. per Card	Std. Pkg. - 1 Pc. OEM Pkg. - 10 Pcs.	Visibility Miles	Replacement Bulb
Bi-Color Light	225°	200 BT DP1	200 BT 12V	2	375 12V 25W
Red Side Light	112-1/2°	200 PT DP1	200 PT 12V	2	375 12V 25W
Green Side Light	112-1/2°	200 SDT DP1	200 SDT 12V	2	375 12V 25W
White Masthead Light	225°	200 MT DP1	200 MT 12V	3	375 12V 25W
White Stern Light	135°	200 SNT DP1	200 SNT 12V	2	375 12V 10W
Yellow Towing Light	135°	200 TWT DP1	200 TWT 12V	2	375 12V 10W

ORDERING INFORMATION - FOR 24 VOLT LIGHTS

Replace the "DP1" with "DP2" For Display Package or the "12V" with "24V" For Standard Package or OEM Package (e.g., 200 BT DP2 or 200 BT 24V). For the Replacement Bulb, Replace the "12V" with "24V" (e.g., 375 24V 25W).

ORDERING INFORMATION - FOR 32 VOLT LIGHTS

Replace the "DP1" with "DP3" For Display Package or the "12V" with "32V" For Standard Package or OEM Package (e.g., 200 BT DP3 or 200 BT 32V). For the Replacement Bulb, Replace the "12V" with "32V" (e.g., 375 32V 25W).



Fig. 200 SNT

Fig. 200 SERIES TOP MOUNT



Fig. 200 TWT



Fig. 200 PT



Fig. 200 BT



Fig. 200 SDT

SPARE PARTS ORDERING INFORMATION

Spare Lens Assembly Part Numbers are Determined by Replacing the Last Three Digits of the Catalog Number with the Letters "LNS" (e.g., 200 BT LNS, for a Bi-Color Top Mount Lens Assembly).
Spare Replacement Bulb Socket, Cat No. 93

NAVIGATION LIGHTS

FOR USE ON SAIL OR POWER DRIVEN VESSELS UNDER 20 METERS (65.6 FT.) IN LENGTH.

**BASE MOUNT. BLACK PLASTIC.
COMPLETE WITH 12, 24 OR 32 VOLT BULB.**



Height Overall Inches	O.D. Base Inches	Height Lens Inches	Screw Size	Weight Ounces
4-7/8	3-5/16	2-3/4	10	9-1/2

ORDERING INFORMATION - FOR 12 VOLT LIGHTS

Description	Visibility Arc	Display Pkg. - 5 Cards 1 Pc. per Card	Std. Pkg. - 1 Pc. OEM Pkg. - 10 Pcs.	Visibility Miles	Replacement Bulb
Bi-Color Light	225°	200 BB DP1	200 BB 12V	2	375 12V 25W
Red Side Light	112-1/2°	200 PB DP1	200 PB 12V	2	375 12V 25W
Green Side Light	112-1/2°	200 SDB DP1	200 SDB 12V	2	375 12V 25W
White Masthead Light	225°	200 MB DP1	200 MB 12V	3	375 12V 25W
White Stern Light	135°	200 SNB DP1	200 SNB 12V	2	375 12V 10W
Yellow Towing Light	135°	200 TWB DP1	200 TWB 12V	2	375 12V 10W
White All-Round Light	360°	200 SWB DP1	200 SWB 12V	2	375 12V 10W
Red All-Round Light	360°	200 SRB DP1	200 SRB 12V	2	375 12V 25W
Green All-Round Light	360°	200 SGB DP1	200 SGB 12V	2	375 12V 25W
Tri-Color Light*	360°	200 TB DP1	200 TB 12V	2	375 12V 25W

*For Use on Vessels Under Sail Alone.

ORDERING INFORMATION - FOR 24 VOLT LIGHTS

Replace the "DP1" with "DP2" For Display Package or the "12V" with "24V" For Standard Package or OEM Package (e.g., 200 BB DP2 or 200 BB 24V). For the Replacement Bulb, Replace the "12V" with "24V" (e.g., 375 24V 25W and 375 24V 10W).

ORDERING INFORMATION - FOR 32 VOLT LIGHTS

Replace the "DP1" with "DP3" For Display Package or the "12V" with "32V" For Standard Package or OEM Package (e.g., 200 BB DP3 or 200 BB 32V). For the Replacement Bulb, Replace the "12V" with "32V" (e.g., 375 32V 25W and 375 32V 10W).



FIG. 200 SNB



FIG. 200 TWB

FIG. 200 SERIES BASE MOUNT



FIG. 200 SGB



FIG. 200 BB



FIG. 200 SRB

SPARE PARTS ORDERING INFORMATION

Spare Lens Assembly Part Numbers are Determined by Replacing the Last Three Digits of the Catalog Number with the Letters "LNS" (e.g., 200 BB LNS, for a Bi-Color Base Mount Lens Assembly).

Spare Replacement Bulb Socket, Cat No. 93

ALL-ROUND NAVIGATION LIGHTS

FOR USE ON SAIL OR POWER DRIVEN VESSELS UNDER 20 METERS (65.6 FT.) IN LENGTH.

HALYARD MOUNT - BLACK PLASTIC WITH STAINLESS STEEL MOUNTING HARDWARE.

BASE MOUNT - BLACK PLASTIC.

COMPLETE WITH 12, 24 OR 32 VOLT BULB.

Description	Height Overall Inches	O.D. Base Inches	Height Lens Inches	Screw Size	Weight Ounces
Halyard	7-1/8	3-5/16	2-3/4	----	9
Base Mount	8-5/8	3-5/16	2-3/4	10	14



ORDERING INFORMATION - FOR 12 VOLT LIGHTS

HALYARD MOUNT

Description	Display Pkg. - 5 Cards 1 Pc. per Card	Std. Pkg. - 1 Pc. OEM Pkg. - 10 Pcs.	Visibility Miles	Replacement Bulb
White All-Round Light	200 SWH DP1	200 SWH 12V	2	375 12V 10W
Red All-Round Light	200 SRH DP1	200 SRH 12V	2	375 12V 25W
Green All-Round Light	200 SGH DP1	200 SGH 12V	2	375 12V 25W

Base Mount

Tri-Color/White All-Round Light*	200 TAB DP1	200 TAB 12V	2/2	375 12V 25W/10W
Masthead/White All-Round Light	200 MAB DP1	200 MAB 12V	3/2	375 12V 25W/10W
Green/Red All-Round Light	200 GRB DP1	200 GRB 12V	2/2	375 12V 25W/25W

ORDERING INFORMATION - FOR 24 VOLT LIGHTS

Replace the "DP1" with "DP2" For Display Package or the "12V" with "24V" For Standard Package or OEM Package (e.g., 200 SRH DP2 or 200 SRH 24V). For the Replacement Bulb, Replace the "12V" with "24V" (e.g., 375 24V 25W).

ORDERING INFORMATION - FOR 32 VOLT LIGHTS

Replace the "DP1" with "DP3" For Display Package or the "12V" with "32V" For Standard Package or OEM Package (e.g., 200 GRB DP3 or 200 GRB 32V). For the Replacement Bulb, Replace the "12V" with "32V" (e.g., 375 32V 25W and 375 32V 10W).



Fig. 200 SRH



Fig. 200 GRB

SPARE PARTS ORDERING INFORMATION

Spare Lens Assembly Part Numbers are Determined by Replacing the Last Three Digits of the Catalog Number with the Letters "LNS" (e.g., 200 SRH LNS, for a Red Halyard Mount Lens Assembly) or (e.g., 200 GRB LNS, for a Green/Red All-Round Lens). Spare Replacement Bulb Sockets: (single and lower for double) Cat. No. 93, (upper for double), Cat. No. 95.

FIG. 222 - PIPE MOUNTING BRACKET

BLACK PLASTIC

COMPLETE WITH SCREWS AND SOFT BLACK MOUNTING GASKET FOR MOUNTING BRACKET TO LIGHT.

For Use on All 200 Series Base Mount Lights.

ORDERING INFORMATION

O.D. Overall Inches	Tapped Pipe Size Inches	Display Pkg. - 5 bags 1 Pc. per bag
3-5/16	1/2	222 DP BLK



Fig. 222



NAVIGATION LIGHTS

FOR USE ON SAIL OR POWER DRIVEN VESSELS UNDER 20 METERS (65.6 FT.) IN LENGTH.

BLACK PLASTIC

FOR 12, 24 OR 32 VOLTS, BULB NOT INCLUDED.



Fig.	Height Overall Inches	Height Lens Inches	Tapped Pipe Size	Screw Size	Weight Pounds
108	6	5	1/2"	10	1-3/4
All Others	5-1/4	4-1/4	----	10	2

ORDERING INFORMATION

Description	Visibility Arc	Standard Pkg. - 1 Pc.	Visibility Miles
Red Side Light	112-1/2°	109 R00 BLK	2
Green Side Light	112-1/2°	109 G00 BLK	2
White Masthead Light	225°	110 000 BLK	3
White Stern Light	135°	111 000 BLK	2
Yellow Towing Light	135°	111 M00 BLK	2
White All-Round Light**	360°	108 000 BLK	2
Red All-Round Light	360°	108 R00 BLK	2
Green All-Round Light	360°	108 G00 BLK	2

*Base Removable for Flush Mounting.

**This Light is Supplied with a Gray Tinted Globe.



FIG. 109



FIG. 110



FIG. 108



FIG. 111



FIG. 109

SPARE PARTS ORDERING INFORMATION

Spare Lenses:

112-1/2°	Fig. No. 259 H02, Specify Color.
135°	Fig. No. 269 H02, Specify Color.
225°	Cat. No. 256 H02 WHT.
360°	Fig. No. 106 000, Specify Color.

Required Bulbs:

For 12 Volts (2 per card), Cat. No. 70 DP1 CLR.
For 24 Volts (2 per card), Cat. No. 67 DP2 CLR.
For 32 Volts (2 per card), Cat. No. 70 DP2 CLR.
Spare Base and Gasket for Fig. No. 108, Cat. No. 222 DP BLK.

MEAL AND ABSENT LIGHT - FIG. 329

CHROME PLATED BRONZE.

DOUBLE CONTACT BAYONET SOCKETS, BULBS NOT INCLUDED.

Blue Owner Absent Light and White Mealtime Light,
Replace Blue and White Flags for Use at Night.
For Mounting on Main Starboard Yardarm.



FIG. 329

Dimensions Base Inches	Length Overall Inches	O.D. Globe Inches	Standard Pkg. - 1 pc.	Screw Size	Weight Pounds
3-3/8 x 1-3/4	9	2-1/2	329 000 CHR	8	2

SPARE PARTS ORDERING INFORMATION

Required Bulbs (2 per card) For 12 Volt Use, Cat. No. 337 011 DP.
Required Bulbs (1 per card) For 32 Volt Use, Cat. No. 337 018 DP.
Spare Socket, Cat. No. 24 DP1.

Spare Blue Globe, Cat. No. 250 000 BLU.
Spare White Globe, Cat. No. 250 000 WHT.

NAVIGATION LIGHTS

FOR USE ON POWER DRIVEN VESSELS UNDER 20 METERS (65.6 FT) IN LENGTH.

**SHEET METAL, GALVANIZED STEEL OR POLISHED BRASS.
BOTTOM OPENING, COMPLETE WITH MOUNTING BRACKET,
FOR 12 OR 32 VOLTS, BULB NOT INCLUDED.**

Height Overall Inches	Height Lens Inches	Screw Size	Weight Pounds
6	5-1/8	6	2

ORDERING INFORMATION

Description	Visibility Arc	Galvanized Steel	Polished Brass	Visibility Miles
Side Lights (Pair)	112-1/2°	91 F03 GAL	91 F03 POL	2
Red Side Light	112-1/2°	91 RF3 GAL	91 RF3 POL	2
Green Side Light	112-1/2°	91 GF3 GAL	91 GF3 POL	2
White Masthead Light	225°	98 F03 GAL	98 F03 POL	3
White Stern Light	135°	99 F03 GAL	99 F03 POL	2



FIG. 98

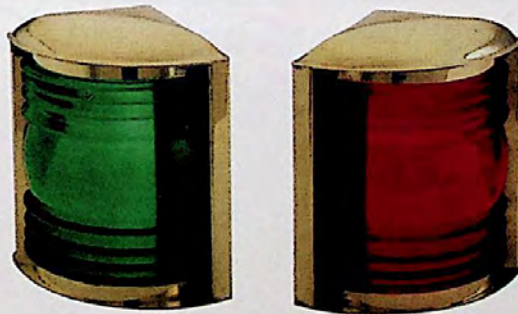

FIG. 91

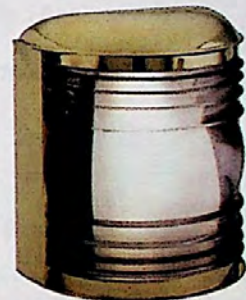

FIG. 99

SPARE PARTS ORDERING INFORMATION

Spare Lenses:

112-1/2° Fig. No. 259 CL3, Specify Color.
135° Fig. No. 269 CL3, Specify Color.
225° Cat. No. 256 CL3 Specify Color.
Spare Mounting Bracket, Cat. No. 92 000 GAL or PLB.
Spare Electric Adapter, Cat. No. 138 F03.

Required Bulbs:

Bulbs for 12 volts (2 per card), Cat. No. 70 DP1 CLR.
Bulbs for 32 volts (2 per card), Cat. No. 70 DP2 CLR.

NAVIGATION LIGHTS

FOR USE ON POWER DRIVEN VESSELS UNDER 20 METERS (65.6 Ft.) IN LENGTH.

**SHEET METAL, GALVANIZED STEEL OR POLISHED BRASS.
BOTTOM OPENING, COMPLETE WITH MOUNTING BRACKET,
FOR 12 OR 32 VOLTS, BULB NOT INCLUDED.**

Height Overall Inches	Height Lens Inches	Screw Size	Weight Pounds
8-1/2	5-1/8	10	3-1/2

ORDERING INFORMATION

Description	Visibility Arc	Galvanized Steel	Polished Brass	Visibility Miles
Side Lights (Pair)	112-1/2°	4 F03 GAL	4 F03 POL	2
Red Side Light	112-1/2°	4 RF3 GAL	4 RF3 POL	2
Green Side Light	112-1/2°	4 GF3 GAL	4 GF3 POL	2
White Masthead Light	225°	5 F03 GAL	5 F03 POL	3
White Stern Light	135°	7 F03 GAL	7 F03 POL	2
Yellow Towing Light	135°	7 MF3 GAL	7 MF3 POL	2



FIG. 7MF



FIG. 7F



FIG. 4F



FIG. 5F

SPARE PARTS ORDERING INFORMATION

Spare Lenses:

112-1/2° Fig. No. 259 CL3, Specify Color.

135° Fig. No. 269 CL3, Specify Color.

225° Cat. No. 256 CL3 WHT.

Spare Mounting Bracket, Cat. No. 131 000 GAL or PLB.

Spare Electric Adapter for No. 3, Cat. No. 290 F03.

Required Bulbs:

Bulbs for No. 3 (12 volts-2 per card), Cat. No. 70 DP1 CLR.

Bulbs for No. 3 (32 volts-2 per card), Cat. No. 70 DP2 CLR.

SPARE BASES FOR POLE LIGHTS

Fig. 1045, 1059-P & 1060-P - PLUG-IN TYPE, WATERPROOF SNAP-ON COVER

Fig. 1045 P00 - FITS FIGS. 940, 970, 1211*, 1612 & 1631 SERIES

Fig. 1059 P00 - FITS FIGS. 1330 & 1630 SERIES

Fig. 1060 P00 - FITS FIGS. 1212* & 1430 SERIES

Locking Collar is Included with Base To Allow Interchangeability with Discontinued Style Bases.

chromalex

ORDERING INFORMATION

Length Overall Inches	Width Overall Inches	Insert Type	Replaces Cat. No.	Display Pkg. - 5 Cards 1 Pc. per Card	Tube Angle Degrees
2-1/4 O.D.	----	None	1023 P00 CHR	1045 P00 DP	0
3-3/4	1-5/8	None	1330 000 99A	1059 P00 DP	16
3-3/4	1-5/8	None	1026 P00 CHR	1059 P00 DP	16
3-3/4	1-3/4	Black	1027 P00 CHR	1060 P00 DP	5
3-3/4	1-3/4	Teak**	1027 P00 CHR	1060 P00 DP	5

*Specify 3-Contact Base (e.g., 1045 300 DP for Fig. No. 1211 or 1060 3B0 DP for Fig. No.1212).

**Teak Insert Bases No Longer Available, Substitute Black Insert Bases.

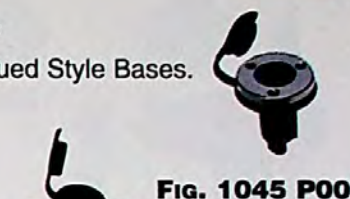

Fig. 1045 P00



Fig. 1059 P00



Fig. 1060 P00

Fig. 1059-T & 1060-T - TELESCOPING TYPE

Fig. 1059 T00 - FITS FIG. 1311 & 1611 SERIES

Fig. 1060 T00 - FITS FIG. 1411 SERIES

Locking Collar is Included with Base To Allow Interchangeability with Discontinued Style Bases.

chromalex

ORDERING INFORMATION

Length Overall Inches	Width Overall Inches	Insert Type	Replaces Cat. No.	Display Pkg. - 5 Cards 1 Pc. per Card	Tube Angle Degrees
3-3/4	1-5/8	None	1156 000 CHR	1059 T00 DP	16
3-3/4	1-5/8	None	1026 T00 CHR	1059 T00 DP	16
3-3/4	1-3/4	Black	1027 T00 CHR	1060 T00 DP	5
3-3/4	1-3/4	Teak**	1027 T00 CHR	1060 T00 DP	5

**Teak Insert Bases No Longer Available, Substitute Black Insert Bases.



Fig. 1059 T00



Fig. 1060 T00

Fig. 1046 & 1047 - PLUG-IN TYPE, WATER RESISTANT SLIDE COVER

Fig. 1046 P00 - FITS FIG. 1640 SERIES

Fig. 1047 P00 - FITS FIG. 1296* & 1660 SERIES

chromalex

ORDERING INFORMATION

Length Overall Inches	Width Overall Inches	Display Pkg. - 5 Cards 1 Pc. per Card	Tube Angle Degrees
3-1/2	1-1/2	1047 P00 DP	0
3-1/2	1-1/2	1046 P00 DP	5

*Specify 3-Contact Base, Cat. No. 1047 3B0 DP.



Fig. 1046

Fig. 1047

Fig. 1125-99A & 1209-99A - PLUG-IN TYPE, WATERPROOF SCREW-ON CAP

Fig. 1125-99A - FITS FIG. 1125

Fig. 1209-99A - FITS FIG. 1209 SERIES

chromalex

ORDERING INFORMATION

Length Overall Inches	Width Overall Inches	Display Pkg. - 5 Cards 1 Pc. per Card	Tube Angle Degrees
3-3/8	2-1/4	1125 DP 99A	16
3-3/8	2-1/4	1209 DP 99A	16



Fig. 1125-99A & 1209-99A

SPARE BASES CONT. & BRACKETS FOR WINDSHIELD MOUNT LIGHTS



FIG. 1048 - PLUG-IN TYPE WITH WATERPROOF SNAP-ON COVER FOR POLES WITH THREADED COLLARS

FITS FIG. 1621

chromalex®

ORDERING INFORMATION



Fig. 1048

Length Overall Inches	Width Overall Inches	Display Pkg. - 5 Cards 1 Pc. per Card	Tube Angle Degrees
3-1/2	1-7/8	1048 P00 DP	5



FIGS. 1052A & 1054A - FOLD-DOWN, ADJUSTABLE ANGLE WITH PLASTIC ADAPTERS FOR "V" OR FLAT MOUNT, CONTAINS NOTCH FOR THROUGH BASE WIRING

FIG. 1052A - HORIZONTAL MOUNT, FITS FIGS. 1181 & 1281
FIG. 1054A - VERTICAL MOUNT, FITS FIGS. 1184 & 1284

Complete with Knob and End Plug.

chromalex®

ORDERING INFORMATION



Fig. 1052A



Fig. 1054A

Length Overall Inches	Width Overall Inches	Replaces Cat. No.	Display Pkg. - 5 Cards 1 Pc. per Card
2	1-1/2	1120 000 CHR	1052 DPA CHR
2-1/4	5/8	1122 000 CHR	1054 DPA CHR



FIGS. 1052 & 1054 - FOLD-DOWN, ADJUSTABLE ANGLE WITH PLASTIC ADAPTERS FOR "V" OR FLAT MOUNT

FIG. 1052 - HORIZONTAL MOUNT, FITS FIGS. 1134 & 1634
FIG. 1054 - VERTICAL MOUNT, FITS FIGS. 1137 & 1637

Complete with Knob and End Plug.

chromalex®

ORDERING INFORMATION



Fig. 1052



Fig. 1054

Length Overall Inches	Width Overall Inches	Replaces Cat. No.	Display Pkg. - 5 Cards 1 Pc. per Card
2	1-1/2	1120 000 CHR	1052 DP CHR
2-1/4	5/8	1122 000 CHR	1054 DP CHR



FIGS. 1123-99A & 1124-99A - PLUG-IN TYPE, WATERPROOF SCREW-ON CAP WITH PLASTIC ADAPTERS FOR "V" OR FLAT MOUNT

FIG. 1123 - HORIZONTAL MOUNT, FITS FIGS. 1123 & 1273 SERIES
FIG. 1124 - VERTICAL MOUNT, FITS FIGS. 1124 & 1274 SERIES

chromalex®

ORDERING INFORMATION



Fig. 1123-99A



Fig. 1124-99A

Dimensions Bracket Inches	Display Pkg. - 5 Cards 1 Pc. per Card
2-1/4 x 3/4	1123 DP 99A
3/4 x 2-1/4	1124 DP 99A

SPARE PARTS

FOR NAVIGATION LIGHTS ON VESSELS UNDER 20 METERS (65.6 FT.) IN LENGTH

FIGS. 138, 290, 291 & 292 - ELECTRIC ADAPTERS

FIGS. 138 & 290 - BRASS SPRING TYPE FOR DOUBLE ENDED BULBS

FIG. 291 - FOR DOUBLE CONTACT BAYONET BASE BULB

FIG. 292 - FOR MEDIUM SCREW BASE BULB

ORDERING INFORMATION

O.D. Overall Inches	I.D. Light Opening Inches	Height Overall Inches	Standard Pkg. - 1 Pc.
2-3/16	1-7/8	3-3/4	138 F03
4-1/2	3-3/16	4-3/4	290 F02
4-1/2	3-3/16	5-1/4	290 F03
3-5/8	3-3/16	2-5/8	291 003 PLB
3-5/8	3-3/16	2-1/8	292 000 PLB



FIG. 291



FIG. 292



FIG. 138



FIG. 290

FIGS. 52 & 276 - DOUBLE CONTACT BAYONET SOCKETS

BRASS, WITH 6 INCH WIRE LEADS - FIG. 276 TAPPED FOR 1/8 INCH PIPE.

ORDERING INFORMATION

Length Overall Inches	Standard Pkg. - 5 Pcs.	Display Pkg. - 10 Cards 1 Pc. per Card
1	-----	52 DP
1-1/2	276 000	
2	276 002	
2-3/8	276 003	
3	276 004	



FIG. 52



FIG. 276



FIG. 24 - DOUBLE CONTACT BAYONET SOCKET

BLACK PLASTIC BODY

ORDERING INFORMATION

Length Pigtail Inches	O.D. Inches	Display Pkg. - 10 Cards 1 Pc. per Card
10	3/4	24 DP1
60	3/4	24 DP2



FIG. 24



FIG. 1109 - SINGLE CONTACT BAYONET SOCKET - BRASS

ORDERING INFORMATION

Length Pigtail Inches	Length Socket Inches	O.D. Inches	Display Pkg. - 10 Cards 1 Pc. per Card
6	5/8	3/8	1109 DP



FIG. 1109



FIG. 230 - LAMP CHIMNEY - GLASS

ORDERING INFORMATION

O.D. Base Inches	Height Overall Inches	Standard Pkg. - 5 Pcs.
1-1/2	4-3/4	230 000 CLR



FIG. 230

SPARE BULBS FOR NAVIGATION LIGHTS

FOR NAVIGATION LIGHTS ON VESSELS UNDER 20 METERS (65.6 FT.) IN LENGTH

FIG. 337 - DOUBLE CONTACT BAYONET BASE BULB



Fig. 337



ORDERING INFORMATION

Nominal Voltage	Wattage	Amps	Display Pkg. 5 cards	Bulbs per card	Bulb Diameter Inches	Mfr. Lamp No.
12	7	.58	337 011 DP	2	3/4	90
12	11	.94	337 012 DP	2	3/4	1004
24	15	.63	337 014 DP	1	1	306
32	13	.40	337 018 DP	1	3/4	624

FIG. 375 - DOUBLE CONTACT BAYONET INDEXING BASE BULB



Fig. 375

ORDERING INFORMATION

Nominal Voltage	Wattage	Amps	Standard Pkg. - 1 bulb
12	10	.83	375 12V 10W
12	25	2.08	375 12V 25W
24	10	.42	375 24V 10W
24	25	1.04	375 24V 25W
32	10	.31	375 32V 10W
32	25	.78	375 32V 25W

FIG. 340 - MEDIUM SCREW BASE BULB



Fig. 340



ORDERING INFORMATION

Nominal Voltage	Wattage	Amps	Standard Pkg. - 6 bulbs	Type	L.C.L. Inches	Mfr. Lamp No.
12	15	1.25	340 005 FRD	A-17	2-3/8	15-A
12	25	2.08	340 006 FRD	A-19	2-9/16	25-A
32	15	.47	340 011 FRD	A-17	2-3/8	15-A
32	25	.78	*340 012 FRD	A-19	2-9/16	25-A

*Standard Pkg. - 2 bulbs

FIG. 338 WEDGE BASE BULBS



Fig. 338 #1



Fig. 338 #2

ORDERING INFORMATION

Nominal Voltage	Wattage	Amps	Display Pkg. - 5 cards 2 Bulbs per card	Bulb Diameter Inches	Bulb Length Inches
12	5	.35	338 DP1 CLR	13/32	1-1/16
12	9	.69	338 DP2 CLR	5/8	1-1/2

FIGS. 67, 69, 70, 71 & 72 FESTOON BULBS - DOUBLE ENDED



Fig. 67

Fig. 69

Fig. 70

Fig. 71

Fig. 72



ORDERING INFORMATION

Nominal Voltage	Wattage	Amps	Display Pkg. - 5 cards 2 Bulbs per card	Bulb Diameter Inches	Bulb Length Inches
12	8	.70	71 DP8 CLR	3/8	1-1/8
12	10	.83	69 DP CLR	3/8	1-5/8
12	10	.74	70 DP0 CLR	3/8	1-11/16
12	15	.97	70 DP1 CLR	9/16	1-11/16
12	10	.80	71 DP CLR	3/8	1-1/8
24	8	.35	72 DP8 CLR	3/8	1-1/8
24	10	.42	67 DP1 CLR	3/8	1-11/16
24	18	.75	67 DP2 CLR	9/16	1-11/16
24	10	.40	72 DP1 CLR	3/8	1-1/8
32	13	.40	70 DP2 CLR	3/8	1-5/8

NAVIGATION LIGHTS FOR VESSELS UNDER 20 METERS

SPARE PARTS - LENSES

FOR NAVIGATION LIGHTS ON VESSELS UNDER 20 METERS (65.6 FT.) IN LENGTH

112-1/2° LENSES FOR BI-COLOR/TRI-COLOR LIGHTS

ORDERING INFORMATION

Color	Height Inches	Width Inches	Display Pkg. - 5 Cards 1 Set per Card
Red/Green	1-5/16	2-1/8	247 DP LNS*
Red/Green	1	1-3/4	283 DPA LNS*
Red/Green	1-1/4	1-3/8	296 DP LNS*
Red/Green	1-1/4	1-3/8	297 DP LNS*
Red/Green	2-1/2	2	259 DPA LNS
Red/Green	1-1/2	1	268 DP LNS
Red/Green	1	1-3/4	289 DPA LNS*

*One Piece Lens



112-1/2° LENSES FOR SIDE LIGHTS

ORDERING INFORMATION

Color	Height Inches	Width Inches	Display Pkg. - 5 Cards 1 Pc. per Card	Std. Pkg. - 1 Pc.
Red	1-5/16	2-1/8	273 DPR LNS	-----
Green	1-5/16	2-1/8	273 DPG LNS	-----
Red	1-3/4	1-1/16	277 DPR LNS	-----
Green	1-3/4	1-1/16	277 DPG LNS	-----
Red	1	1-3/4	298 DPR LNS	-----
Green	1	1-3/4	298 DPG LNS	-----
Red/Green	1	1-9/16	281 DPA LNS*	-----
Red/Green	1	1-9/16	295 DPA LNS*	-----
Red/Green	1-1/4	-----	260 DP LNS*	-----
Red	4-1/4	3-1/16	-----	259 CL2 RED
Green	4-1/4	3-1/16	-----	259 CL2 GRN
Red	5-1/16	3-11/16	-----	259 CL3 RED
Green	5-1/16	3-11/16	-----	259 CL3 GRN

*Set of 1 Red and 1 Green Lens.



225° LENSES FOR MASTHEAD LIGHTS

ORDERING INFORMATION

Color	Height Inches	I.D. Inches	O.D. Inches	Display Pkg. - 5 Cards 1 Pc. per Card	Std. Pkg. - 1 Pc.
White	1	1-9/16	2-3/16	281 DPA WHT	-----
White	1-1/2	1	1-1/4	278 DP WHT*	-----
White	1-1/2	1	1-1/4	295 DP CLR	-----
White	4-1/4	3-3/8	-----	-----	256 CL2 WHT
White	5-1/8	3-1/4	-----	-----	256 CL3 WHT

*Display Pkg., 5 cards - 2 Pcs. per card.



135° LENSES FOR STERN LIGHTS

ORDERING INFORMATION

Color	Height Inches	I.D. Inches	O.D. Inches	Display Pkg. - 5 Cards 1 Pc. per Card	Std. Pkg. - 1 Pc.
White	1-1/4	1-9/16	2-3/16	74 DP WHT	-----
White	1-1/2	1	1-1/4	278 DP WHT*	-----
White	1-1/4	1-9/16	2-3/16	281 DPA WHT	-----
Clear	-----	-----	2	284 DP CLR**	-----
Clear	-----	-----	2	295 DP CLR	-----
White	4-1/4	3-1/2	-----	-----	269 CL2 WHT
White	5-1/8	3-5/8	-----	-----	269 CL3 WHT
Yellow	4-1/4	3-1/2	-----	-----	269 CL2 YLW
Yellow	5-1/8	3-5/8	-----	-----	269 CL3 YLW

*Display Pkg., 5 cards - 2 Pcs. per card.

**Includes Gasket.



360° LENSES FOR ALL-ROUND LIGHTS

ORDERING INFORMATION

Color	Height Inches	I.D. Inches	O.D. Inches	Std. Pkg. - 1 Pc.
Red	5	2-7/8	3-1/4	106 000 RED
Green	5	2-7/8	3-1/4	106 000 GRN
White	5	2-7/8	3-1/4	106 000 WHT
Yellow	5	2-7/8	3-1/4	106 000 YLW
Gray	5	2-7/8	3-1/4	106 000 GRY
White	3	1-1/2	1-9/16	201 DP WHT*
Clear	2-1/2	1-11/16	2	248 DP CLR*
Frosted	2-1/2	1-11/16	2	248 000 FRD
Clear	3-5/16	3-3/16	-----	261 JRO CLR

*Display Pkg., 5 cards - 1 Pc. per card.



NAVIGATION LIGHTS FOR VESSELS UNDER 20 METERS

U.S. COAST GUARD REGULATIONS

FOR NAVIGATION LIGHTS ON VESSELS OVER 20 METERS (65.6 FT.) IN LENGTH.

On March 31, 1977, the U.S. Coast Guard published in the Federal Register, an amendment to the navigation and navigable water regulations, which added a new subchapter DD, (33CFR 87). This subchapter contains rules implementing and interpreting the International Regulations for Preventing Collisions at Sea, 1972 ('72 COLREGS). The International Regulations for Preventing Collisions at Sea, 1960, were replaced by the '72 COLREGS at 1200 hours, zone time on July 15, 1977. Therefore, all vessels on the high seas must comply with the '72 COLREGS at this time. In addition, with the enactment of the U.S. Inland Navigation Rules Act of 1980, the Inland Rules, Western Rules, and Great Lakes Rules were unified into a single set of requirements. The effective date for this legislation was December 24, 1981 (March 1, 1983 for Great Lakes). Therefore, all vessels must comply with these rules at this time.

Rules 21 and 22 of the '72 COLREGS and the U.S. Inland Navigation Rules give the color and range requirements for various navigation lights. Annex 1 to the '72 COLREGS and the U.S. Inland Navigation Rules gives positioning and technical details for these lights.

U.S. COAST GUARD ACCEPTANCE OF NAVIGATION LIGHTS

All U.S. Registered vessels are subject to either the '72 COLREGS or the U.S. Inland Rules. The U.S. Coast Guard is accepting lights that have passed the U.L. tests (U.L. Standard 1104) as meeting the '72 COLREGS and the U.S. Inland Rules for vessels over 20 meters (65.6 ft.) in length. U.S. requirements for smaller vessels are less strict. As the first domestic manufacturer to pass U.L.1104, PERKO's lights can be installed on vessels over 20 meters (65.6 ft.) in length. Some models are designed for use on vessels over 20 meters (65.6 ft.) in length, while others are designed for use on vessels 20 meters (65.6 ft.) to 50 meters (164.0 ft.) in length.

A brass tag is permanently affixed to the light indicating the type of light, catalog no., voltage and bulb type to install to meet the visibility requirements. It also states that the light is classified by U.L. in accordance with the '72 COLREGS. This is the only documentation needed by a vessel for navigation lights to certify light construction compliance with the '72 COLREGS and the Inland Navigation Rules, and eliminates the former "Certificate of Compliance".



EACH LIGHT HAS ITS OWN SERIAL NO. FOR IDENTIFICATION.

The lights indicated for use on vessels over 20 meters (65.6 ft.) in length have passed U.L.1104. The facsimile of the tag shown above is used on our cast bronze lights. Similar rectangular tags are used on other style lights.

Please note that any changes made to PERKO Navigation lights, including substitution of bulbs other than those shown in our catalog, instruction sheets, or metal tags (affixed to some lights) will void all certifications and U.S. Coast Guard acceptance.

For the present, the U.S. Coast Guard will not publish a list of U.L. classified lights. However, field offices have been notified. For more detailed information, consult the complete '72 COLREGS, the U.S. Inland Navigation Rules, and your local U.S. Coast Guard office.

SPECIAL PURPOSE LIGHTS

Other lights (not shown) for use where the vessel is subject to special local requirements are available. Contact PERKO for further information.

SINGLE LENS NAVIGATION LIGHTS

FOR USE ON VESSELS OVER 20 METERS (65.6 FT.) IN LENGTH.

CAST BRONZE.

**COMPLETE WITH A PRE-WIRED MEDIUM PREFOCUS SOCKET AND
3 FEET OF 16/3-SO CABLE THROUGH A WATERTIGHT TERMINAL TUBE.
WATERTIGHT ACCESS CAP FOR REBULBING AND CLEANING.
120 VOLT BULB INCLUDED.**

Height Overall Inches	Height Lens Inches	Weight Pounds	Mounting Bolt Size Inches
9-1/4	6-3/4	11-1/8	3/8

ORDERING INFORMATION

Description	Visibility Arc	Visibility Miles	Cat. No.
Red SideLight	112-1/2°	3	1172 RE0 PLB
Green Side Light	112-1/2°	3	1172 GE0 PLB
White Masthead Light	225°	6	1173 E00 PLB
White Stern Light*	135°	3	1174 E00 PLB
Yellow Towing Light	135°	3	1174 ME0 PLB
White All-Round Light*	360°	3	1169 E00 PLB
White All-Round Light**	360°	6	1169 HE0 PLB
Red All-Round Light	360°	3	1170 RE0 PLB
Green All-Round Light	360°	3	1170 GE0 PLB
Yellow All-Round Light	360°	3	1170 ME0 PLB

Special lights to meet local requirements are available upon request.

*These lights are supplied with a Gray Tinted Lens.

**For Great Lakes use.



IMPORTANT BULB DATA

To comply with U.L. Standard 1104, the lights listed on this page must use a PERKO Cat. No. 342 004 CLR bulb.

SPARE PARTS ORDERING INFORMATION

Spare Lenses:

Red, Cat. No. 261 001 RED
Green, Cat. No. 261 001 GRN
White, Cat. No. 261 001 CLR
Gray, Cat. No. 261 001 GRY
Yellow, Cat. No. 261 001 YLW

Spare Lens Gasket, Cat. No. 1143.
Spare O-Ring for Cap, Cat. No. 1119.
Spare Medium Prefocus Socket, Cat. No. 347.
Spare Lens Retaining Clip with Bolt, Cat. No. 1133.
Spare Access Cap, O-Ring and Retainer, Cat. No. 1105 000 BLK.

DOUBLE LENS NAVIGATION LIGHTS

FOR USE ON VESSELS OVER 20 METERS (65.6 FT.) IN LENGTH.

CAST BRONZE.

EACH COMPARTMENT CONTAINS A PRE-WIRED MEDIUM PREFOCUS SOCKET WITH 3 FEET OF 16/3-SO CABLE THROUGH A WATERTIGHT TERMINAL TUBE.

WATERTIGHT ACCESS CAP FOR REBULBING AND CLEANING.

120 VOLT BULBS INCLUDED.

Height Overall Inches	Height Lens Inches	Weight Pounds	Mounting Bolt Size Inches
17-1/4	6-3/4	22-5/8	3/8

ORDERING INFORMATION

Description	Visibility Arc	Visibility Miles	Cat. No.
Red SideLight	112-1/2°	3	1164 RE0 PLB
Green Side Light	112-1/2°	3	1164 GE0 PLB
White Masthead Light	225°	6	1165 E00 PLB
White Stern Light*	135°	3	1166 E00 PLB
Yellow Towing Light	135°	3	1166 ME0 PLB
White All-Round Light*	360°	3	1167 E00 PLB
White All-Round Light**	360°	6	1167 HE0 PLB
Red All-Round Light	360°	3	1168 RE0 PLB
Green All-Round Light	360°	3	1168 GE0 PLB
Yellow All-Round Light	360°	3	1168 ME0 PLB

Special lights to meet local requirements are available upon request.

*These lights are supplied with a Gray Tinted Lens.

**For Great Lakes use.



IMPORTANT BULB DATA

To comply with U.L. Standard 1104, the lights listed on this page must use a PERKO Cat. No. 342 004 CLR bulb.

SPARE PARTS ORDERING INFORMATION

Spare Lenses:

Red, Cat. No. 261 001 RED
Green, Cat. No. 261 001 GRN
White, Cat. No. 261 001 CLR
Gray, Cat. No. 261 001 GRY
Yellow, Cat. No. 261 001 YLW

Spare Lens Gasket, Cat. No. 1143.
Spare O-Ring for Cap, Cat. No. 1119.
Spare Dual Medium Prefocus Socket Assembly, Cat. No. 303.
Spare Lens Retaining Clip with Bolt, Cat. No. 1133.
Spare Plastic Cap, O-Ring and Retainer, Cat. No. 1105 000 BLK.

NAVIGATION LIGHTS

FOR USE ON VESSEL LENGTHS AS SPECIFIED BELOW.

**SHEET METAL, GALVANIZED STEEL* OR PLAIN BRASS.
COMPLETE WITH A MEDIUM PREFOCUS SOCKET AND A WATERTIGHT TERMINAL TUBE
FOR 16/3-SO CABLE. WATERTIGHT ACCESS CAP FOR REBULBING AND CLEANING.
120 VOLT BULB NOT INCLUDED.**

Size No.	Height Overall Inches	Height Lens Inches	Weight Pounds
1	11-1/2	6-3/4	6-5/8
2	13-1/2	7-1/2	10-7/8



ORDERING INFORMATION

FOR USE ON VESSELS 20 METERS (65.6 FT.) TO 50 METERS (164.0 FT.) IN LENGTH.

Description	Galvanized Steel*	Plain Brass	Visibility Arc	Visibility Miles	Required Bulb
Red Side Light	1150 RE1 GAL	1150 RE1 PLB	112-1/2°	2	342 002 CLR
Green Side Light	1150 GE1 GAL	1150 GE1 PLB	112-1/2°	2	342 002 CLR
White Masthead Light	1151 E01 GAL	1151 E01 PLB	225°	5	342 003 CLR
White Stern Light	1152 E01 GAL	1152 E01 PLB	135°	2	342 000 CLR
Yellow Towing Light	1152 ME1 GAL	1152 ME1 PLB	135°	2	342 000 CLR
White All-Round Light	1153 E01 GAL	1153 E01 PLB	360°	2	342 001 CLR
Red All-Round Light	1154 RE1 GAL	1154 RE1 PLB	360°	2	342 004 CLR
Green All-Round Light	1154 GE1 GAL	1154 GE1 PLB	360°	2	342 003 CLR
Yellow All-Round Light	1154 ME1 GAL	1154 ME1 PLB	360°	2	342 002 CLR

ORDERING INFORMATION

FOR USE ON VESSELS OVER 20 METERS (65.6 FT.) IN LENGTH.

Description	Galvanized Steel*	Plain Brass	Visibility Arc	Visibility Miles	Required Bulb
Red Side Light	1150 RE2 GAL	1150 RE2 PLB	112-1/2°	3	342 004 CLR
Green Side Light	1150 GE2 GAL	1150 GE2 PLB	112-1/2°	3	342 004 CLR
White Masthead Light	1151 E02 GAL	1151 E02 PLB	225°	6	342 004 CLR
White Stern Light	1152 E02 GAL	1152 E02 PLB	135°	3	342 002 CLR
Yellow Towing Light	1152 ME2 GAL	1152 ME2 PLB	135°	3	342 002 CLR
White All-Round Light	1153 E02 GAL	1153 E02 PLB	360°	3	342 003 CLR
Red All-Round Light	1154 RE2 GAL	1154 RE2 PLB	360°	3	342 006 CLR
Green All-Round Light	1154 GE2 GAL	1154 GE2 PLB	360°	3	342 004 CLR
Yellow All-Round Light	1154 ME2 GAL	1154 ME2 PLB	360°	3	342 003 CLR

*Galvanized Steel Lights are Preprimed.



FIG. 1150



FIG. 1151



FIG. 1152



FIG. 1153



FIG. 1154

IMPORTANT BULB DATA

To comply with U.L. Standard 1104, the lights listed on this page must use a PERKO Cat. No. 342 bulb.

SPARE PARTS ORDERING INFORMATION

Spare Lenses:

112-1/2°	Cat. No. 259 No. 1 or 2, Specify Color
135°	Cat. No. 269 No. 1 or 2, Specify Color
225°	Cat. No. 256 No. 1 or 2, Specify Color
360°	Cat. No. 261F No. 1 or 2, Specify Color

Spare Medium Prefocus Socket, Cat. No. 347 A00.
Spare Access Cap, O-Ring and Retainer, Cat. No. 1105 000 BLK.
Spare O-Ring for Cap, Cat. No. 1119.
Spare Socket Supports, Cat. Nos. 341 001 PLB & 341 01A PLB.

NAVIGATION LIGHTS

FOR USE ON VESSELS 20 METERS (65.6 FT.) TO 50 METERS (164.0 FT.) IN LENGTH.

**BLACK PLASTIC.
COMPLETE WITH PRE-WIRED DOUBLE CONTACT SOCKET AND
3 FEET OF 16/3-SO CABLE FOR 12, 24, 32 OR 120 VOLTS.
WATERTIGHT ACCESS CAP FOR REBULBING AND CLEANING.
BULB NOT INCLUDED.**

Height Overall Inches	Height Lens Inches	Screw Size	Weight Pounds
7-1/2	4-1/2	1/4	3-1/8

ORDERING INFORMATION

Description	Visibility Arc	Visibility Miles	Cat. No.
Red Side Light	112-1/2°	2	1127 RA0 BLK
Green Side Light	112-1/2°	2	1127 GA0 BLK
White Masthead Light	225°	5	1128 A00 BLK
White Stern Light*	135°	2	1129 A00 BLK
Yellow Towing Light	135°	2	1129 MA0 BLK
White All-Round Light*	360°	2	1130 A00 BLK
White All-Round Light**	360°	5	1130 HA0 BLK
Red All-Round Light	360°	2	1130 RA0 BLK
Green All-Round Light	360°	2	1130 GA0 BLK
Yellow All-Round Light	360°	2	1130 MA0 BLK



*These lights are supplied with a Gray Tinted Lens.

**For Great Lakes use.



**FIG. 1127
RED & GREEN SIDE LIGHTS
112-1/2 DEGREES**



**FIG. 1128
MASTHEAD LIGHTS
225 DEGREES**



**FIG. 1129
STERN OR
TOWING LIGHTS
135 DEGREES**



**FIG. 1130
ALL-ROUND
LIGHTS
360 DEGREES**

IMPORTANT BULB DATA

To comply with U.L. Standard 1104, the lights listed on this page must use a PERKO Cat. No. 374 bulb.

SPARE PARTS ORDERING INFORMATION

Spare Lens Assemblies:

Red, Cat. No. 249 000 RED.
Green, Cat. No. 249 000 GRN.
White, Cat. No. 249 000 CLR.
Gray, Cat. No. 249 000 GRY.
Yellow, Cat. No. 249 000 YLW.

Spare Double Contact Socket, Cat. No. 134.
Spare Access Cap, O-Ring and Retainer,
Cat. No. 1105 000 BLK.
Spare O-Ring for Cap, Cat. No. 1119.

Required Bulbs:

12 Volts, Cat. No. 374 001 CLR.
24 Volts, Cat. No. 374 002 CLR.
32 Volts, Cat. No. 374 003 CLR.
120 Volts, Cat. No. 374 004 CLR.

NAVIGATION LIGHTS

FOR USE ON VESSELS 20 METERS (65.6 FT.) TO 50 METERS (164.0 FT.) IN LENGTH.

**SHEET METAL, GALVANIZED STEEL*, POLISHED OR CHROME PLATED BRASS.
BOTTOM OPENING, COMPLETE WITH MOUNTING BRACKET
AND SINGLE CONTACT PREFOCUS SOCKET
FOR 12 VOLT USE ONLY. BULB NOT INCLUDED.**

Height Overall Inches	Height Lens Inches	Weight Pounds
8-1/2	5-3/16	3-1/8

ORDERING INFORMATION

Description	Galvanized Steel	Polished Brass	Chrome Plated Brass	Visibility Arc	Visibility Miles	Required Bulb
Red Side Light	4 RD3 GAL	4 RD3 POL	4 RD3 CHR	112-1/2°	2	373 003 CLR
Green Side Light	4 GD3 GAL	4 GD3 POL	4 GD3 CHR	112-1/2°	2	373 002 CLR
White Masthead Light	5 D03 GAL	5 D03 POL	5 D03 CHR	225°	5	373 005 CLR
White Stern Light	7 D03 GAL	7 D03 POL	7 D03 CHR	135°	2	373 001 CLR
Yellow Towing Light	7 MD3 GAL	7 MD3 POL	7 MD3 CHR	135°	2	373 002 CLR

*Galvanized Steel Lights are Preprimed.



FIG. 4



FIG. 5



FIG. 7 & 7M



IMPORTANT BULB DATA

To comply with U.L. Standard 1104, the lights listed on this page must use a PERKO Cat. No. 373 bulb.

SPARE PARTS ORDERING INFORMATION

Spare Lenses:

Red,	112-1/2°	Cat. No. 259 CL3 RED.
Green,	112-1/2°	Cat. No. 259 CL3 GRN.
White,	135°	Cat. No. 269 CL3 WHT.
Gray,	135°	Cat. No. 256 CL3 WHT.
Yellow,	225°	Cat. No. 269 CL3 YLW.

Spare Mounting Bracket; Cat. No. 131 000 GAL or PLB.
Spare Single Contact Prefocus Socket Assembly, Complete
with Stand, Bottom Plate and Gasket, Cat. No. 294 003 PLB.

ALL-ROUND LIGHTS

FOR USE ON VESSELS OVER 20 METERS (65.6 FT.) IN LENGTH.



Fig. 403-3



**CAST BRONZE.
COMPLETE WITH MEDIUM PREFOCUS SOCKET AND 120 VOLT BULB.**

Fig. No.	Height Overall Inches	Height Lens Inches	Tapped Pipe Size Inches	Weight Pounds	Visibility Miles
403	11-1/2	6-3/4	1	8-1/4	3
412	14	6-3/4	*	8-1/4	3

ORDERING INFORMATION

	White	Red	Green	Yellow
Fig. No. 403	403 E03 PLB**	403 RE3 PLB	403 GE3 PLB	403 ME3 PLB
Fig. No. 412	412 E00 PLB**	412 RE0 PLB	412 GE0 PLB	412 ME0 PLB

*Supplied with watertight terminal tube for 16/3-SO cable.
**These Lights are Supplied with Gray Tinted Lenses.

IMPORTANT BULB DATA

To comply with U.L. Standard 1104, the lights listed on this page must use a PERKO Cat. No. 342 004 CLR bulb.

SPARE PARTS ORDERING INFORMATION

Spare Lenses:		Spare Lens or Cover Gasket, Cat. No. 1143.	
Gray, Cat. No. 261 001 GRY.			
Red, Cat. No. 261 001 RED.		Spare Medium Prefocus Socket, Cat. No. 347.	
Green, Cat. No. 261 001 GRN.			
Yellow, Cat. No. 261 001 YLW.			



Fig. 412

FOR USE ON VESSELS 20 METERS (65.6 FT.) TO 50 METERS (164.0 FT.) IN LENGTH.



Fig. 112A



**CAST BRONZE. PLAIN OR CHROME PLATED.
COMPLETE WITH DOUBLE CONTACT ELECTRICAL SOCKET
FOR 12, 24, 32 OR 120 VOLTS. BULB NOT INCLUDED.**

Fig. No.	Height Overall Inches	Diameter Base Inches	Tapped Pipe Size Inches	Weight Pounds	Visibility Miles
112	8-3/4	3-1/8	----	2-1/2	2
309	6-1/2	----	1/2	2-1/4	2

ORDERING INFORMATION

Description	Plain Bronze	Chrome Plated Bronze
White All-Round	112 A00 PLB	112 A00 CHR
Red All-Round	112 RA0 PLB	112 RA0 CHR
Green All-Round	112 GA0 PLB	112 GA0 CHR
Yellow All-Round	112 MA0 PLB	112 MA0 CHR

ORDERING INFORMATION

Description	Plain Bronze	Chrome Plated Bronze
White All-Round	309 A00 PLB	309 A00 CHR
Red All-Round	309 RA0 PLB	309 RA0 CHR
Green All-Round	309 GA0 PLB	309 GA0 CHR
Yellow All-Round	309 MA0 PLB	309 MA0 CHR

IMPORTANT BULB DATA

To comply with U.L. Standard 1104, the lights listed on this page must use a PERKO Cat. No. 374 bulb.

SPARE PARTS ORDERING INFORMATION

Spare Lenses:		Required Bulbs:	
Red, Cat. No. 106 000 RED.		12 Volts, Cat. No. 374 001 CLR.	
Green, Cat. No. 106 000 GRN.		24 Volts, Cat. No. 374 002 CLR.	
White, Cat. No. 106 000 WHT.		32 Volts, Cat. No. 374 003 CLR.	
Yellow, Cat. No. 106 000 YLW.		120 Volts, Cat. No. 374 004 CLR.	
Spare Double Contact Bayonet Socket, Cat. No. 276 002.			



Fig. 309A

SPECIAL PURPOSE LIGHTS

FIG. 1111ME - FOR USE ON VESSELS OF ANY LENGTH.

SHEET METAL, GALVANIZED STEEL* OR PLAIN BRASS. COMPLETE WITH MEDIUM PREFOCUS SOCKET AND WATERTIGHT TERMINAL TUBE FOR 16/3-SO CABLE. SEALED FLASHER UNIT, WATERTIGHT ACCESS CAP FOR REBULBING AND CLEANING. 120 VOLT BULB NOT INCLUDED.

Designed to meet Federal Requirements for Flashing yellow 180° - 225° light for barges, canal boats, etc., that are being pushed ahead or towed along side of a tug boat. For use on 120 volts A.C. only. Federal Requirements for this light are applicable for: inland waters, the Atlantic, Pacific and Gulf coasts, intercoastal waterways and western rivers. Refer to the U.S. Inland Navigation Rules for application, configuration and technical details.

ORDERING INFORMATION

Galvanized Steel*	Plain Brass	Height Overall Inches	Height Lens Inches	Visibility Miles	Visibility Arc	Flashes Per Minute	Weight Pounds
1111 ME1 GAL	1111 ME1 PLB	11-1/2	6-3/4	2	225°	50-70	6-5/8

*Galvanized Steel Lights are Preprimed.

IMPORTANT BULB DATA

To comply with Federal Requirements this light must use a PERKO Cat. No. 342 004 CLR bulb.

SPARE PARTS ORDERING INFORMATION

Spare Lenses:

Spare Flasher, Cat. No. 133.

Spare Medium Prefocus Socket, Cat. No. 347 A00.

Spare O-Ring for Cap, Cat. No. 1119.

Spare Access Cap, O-Ring and Retainer, Cat. No. 1105 000 BLK.

Spare Lens, Cat. No. 256 001 YLW.



Fig. 1111ME

FIG. 1129BA - PANAMA CANAL BLUE STEERING LIGHT FOR USE ON VESSELS OF ANY LENGTH.

BLACK PLASTIC, PRE-WIRED DOUBLE CONTACT SOCKET WITH 3 FEET OF 16/3-SJO CABLE. FOR 12, 24, 32 OR 120 VOLTS, BULB NOT INCLUDED.

ORDERING INFORMATION

Cat. No.	Visibility Arc	Height Overall Inches	Height Lens Inches	Weight Pounds
1129 BAO BLK	135°	7-1/2	4-1/2	3-1/8

IMPORTANT BULB DATA

To comply with Panama Canal Requirements this light must use a PERKO Cat. No. 374 bulb.

SPARE PARTS ORDERING INFORMATION

Spare Lenses:

12 Volts, Cat. No. 374 001 CLR.

Spare Lens, Cat. No. 249 000 BLU.

24 Volts, Cat. No. 374 002 CLR.

Spare O-Ring for Cap, Cat. No. 1119.

32 Volts, Cat. No. 374 003 CLR.

Spare Double Contact Socket, Cat. No. 134.

120 Volts, Cat. No. 374 004 CLR.

Spare Plastic Cap, O-Ring and Retainer, Cat. No. 1105 000 BLK.



Fig. 1129BA

FIG. 454E - ALL-ROUND WHITE WHISTLE LIGHT FOR USE ON VESSELS OVER 20 METERS (65.6 FT.) IN LENGTH.

CAST BRONZE.

COMPLETE WITH MEDIUM PREFOCUS SOCKET AND 120 VOLT BULB.

ORDERING INFORMATION

Cat. No.	Height Overall Inches	Height Lens Inches	Tapped Pipe Size Inches	Weight Pounds	Visibility Miles
454 E00 PLB	11-1/2	6-3/4	1	8-1/4	5

SPARE PARTS ORDERING INFORMATION

Spare Lenses:

Spare Bulb, Cat. No. 342 004 CLR.

Spare Lens or Cover Gasket, Cat. No. 1143.

Spare Lens, Cat. No. 261 001 CLR.

Spare Medium Prefocus Socket, Cat. No. 347.



Fig. 454E

SEARCHLIGHTS

FIGS. 534 & 538 - DECK CONTROL SEARCHLIGHTS

FIG. 534 - CHROME PLATED BRASS HEAD WITH CHROME PLATED BRONZE BASE

FIG. 538 - CHROME PLATED BRASS HEAD WITH CHROME PLATED BRASS BASE FOR 12, 24 OR 32 VOLTS, 4-1/2 OR 7 INCH SEALED BEAM BULB, TUNGSTEN OR HALOGEN, SWITCH IN HEAD.

ORDERING INFORMATION

Voltage	O.D. Bulb Inches	Approx. Range Miles	Beam Candlepower	Wattage	Height Overall Inches	Base Dimension Inches	Catalog Number	Weight Pounds
12	4-1/2	1/4	50,000	30	7-1/2	3-1/2 O.D.	538 000 CHR	1-1/2
12	4-1/2	1/3	100,000	50	7-1/2	3-1/2 O.D.	538 H00 CHR*	1-1/2
12	7	5/8	250,000	100	12-1/2	4-7/8 x 3-1/8	534 003 12V	5
24	7	3/4	470,000	450	12-1/2	4-7/8 x 3-1/8	534 003 24V	5
32	7	5/8	260,000	200	12-1/2	4-7/8 x 3-1/8	534 003 32V	5

*NOTE: "H" in the Catalog Number Designates a Halogen Bulb.



Fig. 534



Fig. 538

FIG. 440 - REMOVABLE DECK CONTROL SEARCHLIGHT

CHROME PLATED BRASS HEAD WITH CHROME PLATED ZINC BASE FOR 12 OR 32 VOLTS, 4-1/2 OR 7 INCH SEALED BEAM BULB COMPLETE WITH 8 FEET OF COILED CORD, CIGARETTE LIGHTER PLUG AND WATERTIGHT DECK CONNECTION. SWITCH IN HEAD.

ORDERING INFORMATION

Voltage	O.D. Bulb Inches	Approx. Range Miles	Beam Candlepower	Wattage	Height Overall Inches	Catalog Number	Weight Pounds
12	4-1/2	1/4	50,000	30	7-1/2	440 001 12V	2-1/4
12	4-1/2	1/3	100,000	50	7-1/2	440 H01 12V*	2-1/4
12	7	5/8	250,000	100	10	440 003 12V	3-1/2
32	7	5/8	260,000	200	10	440 003 32V	3-1/2



Fig. 440

Base Diameter, 2-1/8 Inches.

*NOTE: "H" in the Catalog Number Designates a Halogen Bulb.

FIG. 535 - PILOT HOUSE CONTROL SEARCHLIGHT

CHROME PLATED BRASS HEAD WITH CHROME PLATED BRONZE BASE FOR 12, 24 OR 32 VOLTS, 7 INCH SEALED BEAM BULB.

Lever Handle Controls both Horizontal and Vertical Movement.

Control Length, 7-1/2 Inches.

Maximum Ceiling Thickness, 4-1/2 Inches.

ORDERING INFORMATION

Voltage	Approx. Range Miles	Beam Candlepower	Wattage	Catalog Number
12	5/8	250,000	100	535 003 12V
24	3/4	470,000	450	535 003 24V
32	5/8	260,000	200	535 003 32V

Base Diameter, 4-7/8 x 3-1/8 Inches.

Weight, 5 Pounds.



Fig. 535

SPARE SEALED BEAM ORDERING INFORMATION

Spare 4-1/2 Inch Sealed Beam Unit, Cat. No. 433 001 12V.

Spare 4-1/2 Inch Halogen Sealed Beam Unit, Cat. No. 435 001 12V.

Spare 7 Inch Sealed Beam Unit (12 Volt), Cat. No. 433 003 12V.

Spare 7 Inch Sealed Beam Unit (24 Volt), Cat. No. 433 003 24V.

Spare 7 Inch Sealed Beam Unit (32 Volt), Cat. No. 433 003 32V.

SEALED BEAM SEARCHLIGHTS

**BRONZE BASE, BRASS BODY.
POLISHED CHROME PLATED OR WHITE PERKO•KOTE POWDER COATING.
FOR 12, 24 OR 32 VOLTS.**

Dimensions (Inches)

"A"	"B"	"C"	"D"	"G"	"H"
8	8-1/2	10	7	2	2-1/8

Electrical Specifications

Voltage	Wattage	Approximate Candlepower	Sealed Beam Range Miles	Spare Bulb Catalog No.
12	100	250,000	5/8	433 003 12V
24	450	470,000	3/4	433 003 24V
32	200	260,000	5/8	433 003 32V

Figs. 305 & 313 - SEARCHLIGHT HEADS



Fig. 313

ORDERING INFORMATION

Head Only Polished Chrome For Lever Control	Head Only White PERKO•KOTE For Lever Control	Head Only Polished Chrome For Wheel or Lever/Gear Control	Head Only White PERKO•KOTE For Wheel or Lever/Gear Control
Voltage	Voltage	Voltage	Voltage
12	12	12	12
24	24	24	24
32	32	32	32
Cat. No.	Cat. No.	Cat. No.	Cat. No.
305 H12 CHR	305 H12 WHT	313 H12 CHR	313 H12 WHT
305 H24 CHR	305 H24 WHT	313 H24 CHR	313 H24 WHT
305 H32 CHR	305 H32 WHT	313 H32 CHR	313 H32 WHT

Nominal Weight - 20 lbs.

Fig. 354 Spare Front Bezel with Glass for Figs. 305 & 313, Specify Chrome or White.
Fig. 355 Spare Rear Cover for Figs. 305 & 313, Specify Chrome or White.

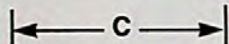

Fig. 305

Figs. 851, 852 & 969 - CONTROL ASSEMBLIES

STAINLESS STEEL TUBES WITH CHROME PLATED FITTINGS.

Control Assemblies of Different Types May Be Interchanged to Offer a Large Variety of Searchlights With a Minimum of Inventory.

Note: Lever Control (Fig. 851) Fits Fig. 305 Head Assemblies.
Wheel Control (Fig. 852) and Lever/Gear Control (Fig. 969) Fits Fig. 313 Head Assemblies.

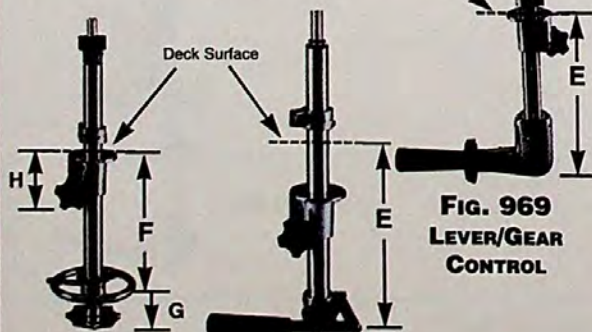

**Fig. 852
WHEEL
CONTROL**

**Fig. 851
LEVER CONTROL**

**Fig. 969
LEVER/GEAR
CONTROL**

ORDERING INFORMATION

Control Length Inches	"E" Lever Control* Cat. No.	"E" Lever/Gear Control Cat. No.	"F" Wheel Control Cat. No.	Nominal Weight Pounds
8-1/2	851 000*	969 000**	852 000***	6
15-1/2	851 0A0	969 0A0	852 0A0	9
22-1/2	851 0B0	969 0B0	852 0B0	12
29-1/2	851 0C0	969 0C0	852 0C0	15

*Maximum Ceiling Thickness, 4-1/2 Inches.

**Maximum Ceiling Thickness, 3-1/2 Inches.

***Maximum Ceiling Thickness, 3 Inches.

SOLAR-RAY® SEARCHLIGHTS

800 SERIES

10", 12" OR 14"

**CAST BRONZE AND HEAVY GAUGE BRASS.
POLISHED CHROME OR WHITE PERKO•KOTE FINISH.
12, 24, 32, 120 OR 230 VOLTS.**

The 800 Series - Solar-Ray® Searchlights are available in 10", 12" and 14" sizes with your choice of Deck, Wheel, or Lever/Gear Controls. All models feature: halo deflectors, parabolic glass mirror reflectors for maximum light output and ventilation covers for quick dissipation of heat to help prolong bulb life. Hinged front doors have quick release stainless steel latches to provide easy access for bulb replacement. The 800 Series models are also available in our white PERKO•KOTE finish; an advanced powder coating process that eliminates the need for painting while providing a scratch resistant and chip-proof surface for painting when necessary to match the color of the vessel.

Bulbs are not included and must be ordered separately. PERKO offers a choice of the traditional incandescent or the brighter, more piercing quartz-halogen bulbs in a broad variety of voltages and wattages to fit every need. For complete information on bulbs and candlepower output, see page 55.



CONTROL TYPES



DECK CONTROL

Equipped with handles on the rear cover for positioning.

LEVER CONTROL

Aim handle for horizontal position. Move handle up and down for vertical position.

WHEEL CONTROL

Turn upper wheel for horizontal position. Turn lower wheel for vertical position.

LEVER/GEAR CONTROL

Aim handle for horizontal position. Twist handle for vertical position.



DECK CONTROL SOLAR-RAY® SEARCHLIGHTS

883 SERIES

10", 12" OR 14"

SEARCHLIGHT DIMENSIONS

"A" Nominal Drum Diameter Inches	"C" Length Drum Inches	Nominal Weight Pounds
10	13	28
12	15	38
14	17	45



FIG. 883 - STANDARD PEDESTAL

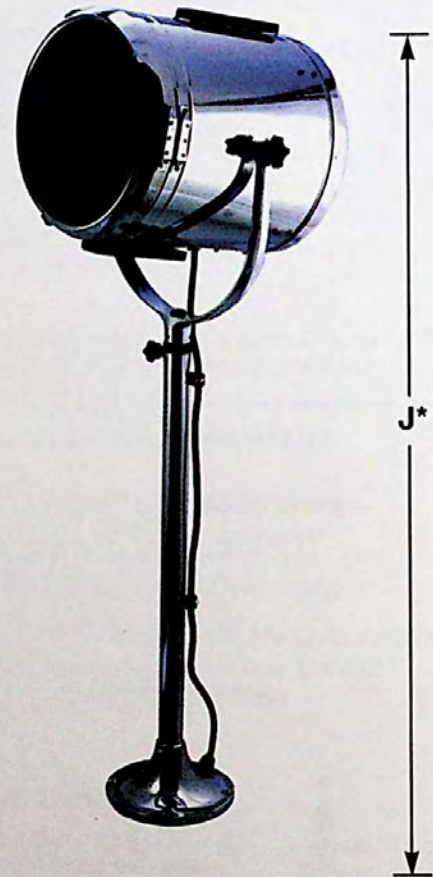

FIG. 883 - HIGH PEDESTAL



FIG. 883 - MEDIUM PEDESTAL

* Note: The "J" Dimension is Height Overall.

DECK CONTROL SOLAR-RAY® SEARCHLIGHTS**883 SERIES****10", 12" OR 14"****ORDERING INFORMATION**

- NOTES: 1) These Searchlights Cannot Be Fitted With Controls.
 2) Bulbs Must be Ordered Separately, Refer to Pages 54 and 55 for Ordering Information.
 3) Refer to Worksheet on Page 56 For Help in Ordering.

STANDARD PEDESTAL SEARCHLIGHTS

Reflector Size Inches	"J" Height Overall Inches	Polished Chrome Catalog No.	White PERKO•KOTE Catalog No.
10	20-1/8	883 OP1 CHR	883 OP1 WHT
12	22-1/8	883 OP2 CHR	883 OP2 WHT
14	25-1/8	883 OP3 CHR	883 OP3 WHT

Standard Pedestal Base Diameter, 7 Inches.

MEDIUM PEDESTAL SEARCHLIGHTS

Reflector Size Inches	"J" Height Overall Inches	Polished Chrome Catalog No.	White PERKO•KOTE Catalog No.
10	27-1/2	883 MP1 CHR	883 MP1 WHT
12	29-1/2	883 MP2 CHR	883 MP2 WHT
14	32-1/2	883 MP3 CHR	883 MP3 WHT

Medium Pedestal Base Diameter, 8 Inches.

HIGH PEDESTAL SEARCHLIGHTS

Reflector Size Inches	"J" Height Overall Inches	Polished Chrome Catalog No.	White PERKO•KOTE Catalog No.
10	44	883 HP1 CHR	883 HP1 WHT
12	46	883 HP2 CHR	883 HP2 WHT
14	49	883 HP3 CHR	883 HP3 WHT

High Pedestal Base Diameter, 8 Inches.

**NOTE: Custom Pedestal Heights are Available.
 Price Upon Application.
 Specify the "J" Dimension for Custom Pedestal Height.**

LEVER CONTROL SOLAR-RAY® SEARCHLIGHTS

884 SERIES

10", 12" AND 14"

SEARCHLIGHT DIMENSIONS

"A" Nominal Drum Diameter Inches	"C" Length Drum Inches	Nominal Weight Pounds
10	13	28
12	15	38
14	17	45

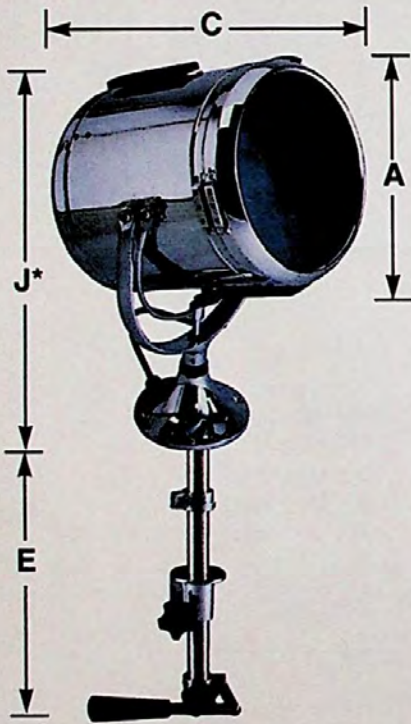

**FIG. 884
STANDARD PEDESTAL**

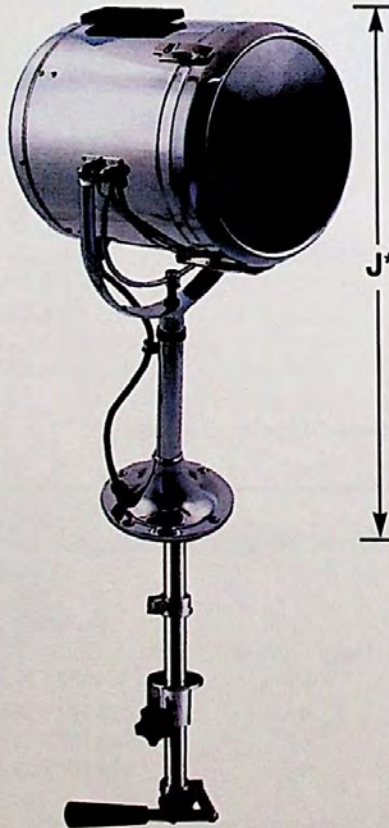

**FIG. 884
MEDIUM PEDESTAL**

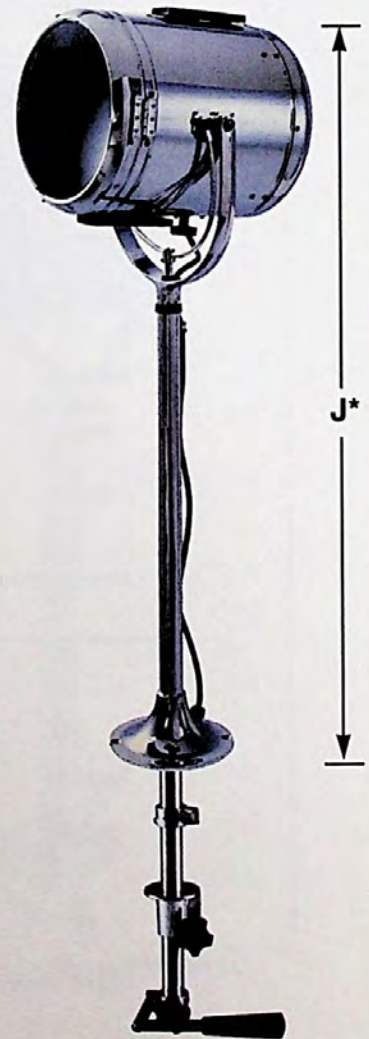

**FIG. 884
HIGH PEDESTAL**

* Note: The "J" Dimension is height from mounting surface to the top of the light.

LEVER CONTROL SOLAR-RAY® SEARCHLIGHT HEAD ASSEMBLIES

884 SERIES

10", 12" AND 14"

ORDERING INFORMATION

- NOTES: 1) Bulbs Must be Ordered Separately, Refer to Pages 54 and 55 for Ordering Information.
2) Refer to Worksheet on Page 56 For Help in Ordering.

STANDARD PEDESTAL SEARCHLIGHT HEAD ASSEMBLIES

Reflector Size Inches	"J" Height Inches	Polished Chrome Catalog No.	White PERKO•KOTE Catalog No.
10	20-1/8	884 0P1 CHR	884 0P1 WHT
12	22-1/8	884 0P2 CHR	884 0P2 WHT
14	25-1/8	884 0P3 CHR	884 0P3 WHT

Standard Pedestal Base Diameter, 7 Inches.

MEDIUM PEDESTAL SEARCHLIGHT HEAD ASSEMBLIES

Reflector Size Inches	"J" Height Inches	Polished Chrome Catalog No.	White PERKO•KOTE Catalog No.
10	28-1/4	884 MP1 CHR	884 MP1 WHT
12	30-1/4	884 MP2 CHR	884 MP2 WHT
14	33-1/4	884 MP3 CHR	884 MP3 WHT

Medium Pedestal Base Diameter, 8 Inches.

HIGH PEDESTAL SEARCHLIGHT HEAD ASSEMBLIES

Reflector Size Inches	"J" Height Inches	Polished Chrome Catalog No.	White PERKO•KOTE Catalog No.
10	44-3/4	884 HP1 CHR	884 HP1 WHT
12	46-3/4	884 HP2 CHR	884 HP2 WHT
14	49-3/4	884 HP3 CHR	884 HP3 WHT

High Pedestal Base Diameter, 8 Inches.

NOTE: Custom Pedestal Heights are Available. Price Upon Application. Specify the "J" Dimension for Custom Pedestal Height.

FIG. 851 - LEVER CONTROL ASSEMBLIES

Control assemblies of different lengths may be interchanged on Solar-Ray® searchlights (Fig. 884) of the same pedestal height. The following chart makes it possible to order and stock different styles of these assemblies separately to offer a large variety of Solar-Ray® searchlights with a minimum of inventory.

ORDERING INFORMATION

"E" Length Control Inches	For Standard Pedestal Cat. No.	For Medium Pedestal Cat. No.	For High Pedestal Cat. No.	Nominal Weight Pounds
8-1/2	851 000*	851 M00*	851 H00*	6
15-1/2	851 0A0	851 MA0	851 HA0	9
22-1/2	851 0B0	851 MB0	851 HB0	12
29-1/2	851 0C0	851 MC0	851 HC0	15

* Maximum Ceiling Thickness, 4-1/2 Inches.

NOTE: Custom Control Lengths are Available. Price Upon Application. Specify the "E" Dimension for Custom Control Lengths.

WHEEL OR LEVER/GEAR CONTROL SOLAR-RAY® SEARCHLIGHTS

885 SERIES

10", 12" AND 14"

SEARCHLIGHT DIMENSIONS

"A" Nominal Drum Diameter Inches	"C" Length Drum Inches	Nominal Weight Pounds
10	13	28
12	15	38
14	17	45

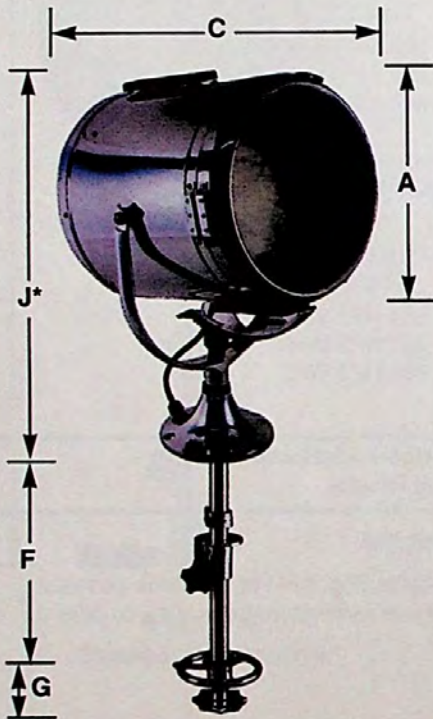

**FIG. 885
STANDARD PEDESTAL**



**FIG. 885
MEDIUM PEDESTAL**

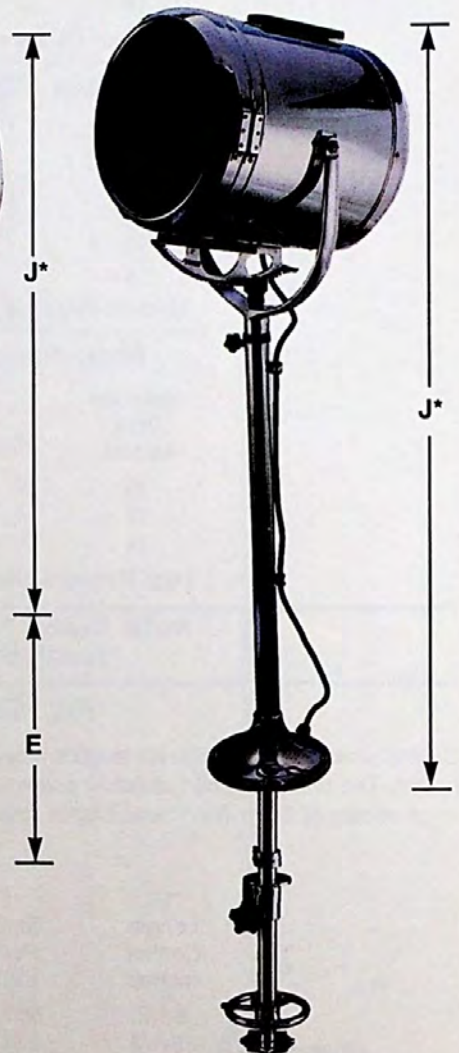

**FIG. 885
HIGH PEDESTAL**

* Note: The "J" Dimension is height from mounting surface to the top of the light.

WHEEL OR LEVER/GEAR CONTROL SOLAR-RAY® SEARCHLIGHTS HEAD ASSEMBLIES

885 SERIES

10", 12" AND 14"

ORDERING INFORMATION

- Notes: 1) Bulbs Must be Ordered Separately, Refer to Pages 54 and 55 for Ordering Information.
2) Refer to Worksheet on Page 56 For Help in Ordering.

STANDARD PEDESTAL SEARCHLIGHT HEAD ASSEMBLIES

Reflector Size Inches	"J" Height Overall Inches	Polished Chrome Catalog No.	White PERKO•KOTE Catalog No.
10	20-1/8	885 0P1 CHR	885 0P1 WHT
12	22-1/8	885 0P2 CHR	885 0P2 WHT
14	25-1/8	885 0P3 CHR	885 0P3 WHT

Standard Pedestal Base Diameter, 7 Inches.

MEDIUM PEDESTAL SEARCHLIGHT HEAD ASSEMBLIES

Reflector Size Inches	"J" Height Overall Inches	Polished Chrome Catalog No.	White PERKO•KOTE Catalog No.
10	28-1/4	885 MP1 CHR	885 MP1 WHT
12	30-1/4	885 MP2 CHR	885 MP2 WHT
14	33-1/4	885 MP3 CHR	885 MP3 WHT

Medium Pedestal Base Diameter, 8 Inches.

HIGH PEDESTAL SEARCHLIGHT HEAD ASSEMBLIES

Reflector Size Inches	"J" Height Overall Inches	Polished Chrome Catalog No.	White PERKO•KOTE Catalog No.
10	44-3/4	885 HP1 CHR	885 HP1 WHT
12	46-3/4	885 HP2 CHR	885 HP2 WHT
14	49-3/4	885 HP3 CHR	885 HP3 WHT

High Pedestal Base Diameter, 8 Inches.

NOTE: Custom Pedestal Heights are Available. Price Upon Application. Specify the "J" Dimension for Custom Pedestal Height.

CONTROL ASSEMBLIES - FIGS. 852 & 969

Control Assemblies of different lengths may be interchanged on Solar-Ray® searchlights (Fig. 885) of the same pedestal height. The following chart makes it possible to order and stock different styles of these assemblies separately to offer a large variety of Solar-Ray® Searchlights with a minimum of inventory.

WHEEL CONTROL - FIG. 852

ORDERING INFORMATION

"F" Length Control Inches	For Standard Pedestal Cat. No.	For Medium Pedestal Cat. No.	For High Pedestal Cat. No.	Nominal Weight Pounds
7-1/2	852 000*	852 M00*	852 H00*	6
14-1/2	852 0A0	852 MA0	852 HA0	9
21-1/2	852 0B0	852 MB0	852 HB0	12
28-1/2	852 0C0	852 MC0	852 HC0	15

"G" Distance Between Wheels, 2 Inches.

*Maximum Ceiling Thickness, 3 Inches.

LEVER/GEAR CONTROL - FIG. 969

ORDERING INFORMATION

"E" Length Control Inches	For Standard Pedestal Cat. No.	For Medium Pedestal Cat. No.	For High Pedestal Cat. No.	Nominal Weight Pounds
8-1/2	969 000*	969 M00*	969 H00*	6
15-1/2	969 0A0	969 MA0	969 HA0	9
22-1/2	969 0B0	969 MB0	969 HB0	12
29-1/2	969 0C0	969 MC0	969 HC0	15

*Maximum Ceiling Thickness, 3-1/2 Inches.

NOTE: Custom Control Lengths are Available. Price Upon Application. Specify the "E" or "F" Dimension for Custom Control Lengths.

BULB AND SOCKET ORDERING INFORMATION FOR SOLAR-RAY® SEARCHLIGHTS

800 SERIES - 10", 12" AND 14"

BULBS ARE NOT INCLUDED IN LIGHTS

To give good results, the bulb and reflector must be perfectly compatible; therefore be sure to specify the catalog number of the bulb desired. Peak candlepower is exceedingly sensitive to many factors, (i.e., a light source out of focus by 1/32 inch, under-voltage of only 4%, or differences between bulb manufacturers) which can cause a reduction of range of up to 20%.

INCANDESCENT BULB ORDERING INFORMATION

Bulb Catalog Number	Voltage	Wattage	Socket Type	Socket Code Letter	For Searchlight Sizes Inches	Rated* Life Hours	Mfg. Bulb Code
806	32	500	Medium Screw	B	10, 12, 14	50	DLT
807	120	500	Medium Prefocus	E	10, 12, 14	25	CZX
809	120	750	Medium Prefocus	E	12, 14	25	DDB
837	120	750	Medium Prefocus	E	12, 14	200	DGH
810	120	1000	Medium Prefocus	E	12, 14	25	DRS
811	120	1000	Mogul Screw	D	12, 14	50	DPT
860	230	1000	Medium Prefocus	E	12, 14	50	DWK

For a More Concentrated Beam, Longer Range, Brighter Light and a Longer Life, We Recommend the Following Bulbs:

"QUARTZ" TUNGSTEN-HALOGEN BULB ORDERING INFORMATION

Bulb Catalog Number	Voltage	Wattage	Socket Type	Socket Code Letter	For Searchlight Sizes Inches	Rated* Life Hours	Mfg. Bulb Code
816	12	100	2-Pin Prefocus	F	10, 12, 14	50	FDT
836	24	150	2-Pin Prefocus	G	10, 12, 14	50	DZE-FDS
817	32	200	2-Pin Prefocus	H	10, 12, 14	200	G.E. 1945
844	120	500	Medium Prefocus	E	10, 12, 14	500	BTL
820	120	600	2-Pin Prefocus	I	10, 12, 14	75	DYS
845	120	750	Medium Prefocus	E	12, 14	200	BTP
839	120	900	2-Pin Prefocus	K	12, 14	75	BVA
846	120	1000	Medium Prefocus	E	12, 14	200	BTR

PLEASE ORDER CAREFULLY, BULBS ARE NOT RETURNABLE.

*NOTE: These are the "Rated Average Laboratory Life in Hours" of the Bulb Manufacturer obtained in closely controlled laboratory life testing groups of lamps at their design voltage. It is not necessarily the same as the service life where conditions such as shock, vibration, voltage fluctuation and environment may result in a shorter average attained life.

ELECTRIC SOCKET AND SUPPORT STAND ASSEMBLIES

Solar-Ray® Searchlights include a socket and support stand assembly based on the bulb or socket information given when ordering. The following chart makes it possible to order and stock different socket and stand assemblies for field conversion to meet a large variety of voltage and candlepower requirements with a minimum of inventory.

ORDERING INFORMATION

Socket Type	Socket Code	For 10" Searchlights		For 12" Searchlights		For 14" Searchlights	
		Catalog Number	Height Stand Inches	Catalog Number	Height Stand Inches	Catalog Number	Height Stand Inches
Medium Screw	B	872 001	1-1/4	872 002	2-1/4	872 003	3-1/4
Medium Prefocus	E	873 001	1-5/16	873 002	1-15/16	873 003	2-15/16
Mogul Screw	D	-----	-----	874 002	7/16	874 003	1-1/4
2-Pin Prefocus (12 Volt)	F	875 001	3-1/2	875 002	4-1/2	875 003	5-1/2
2-Pin Prefocus (24 Volt)	G	876 001	3-1/4	876 002	4-1/4	876 003	5-1/4
2-Pin Prefocus (32 Volt)	H	878 001	3-1/4	878 002	4-1/4	878 003	5-1/4
2-Pin Prefocus (600 Watt)	I	879 001	3-1/8	879 002	4-1/8	879 003	5-1/8
2-Pin Prefocus (900 Watt)	K	-----	-----	880 002	3-13/16	880 003	4-13/16

NOTE: Refer to Page 60 for Spare/Replacement Electric Socket Only Ordering Information.

BULB TECHNICAL DATA FOR SOLAR-RAY® SEARCHLIGHTS

800 SERIES

THE FOLLOWING CHART IS PROVIDED TO AID IN PROPER BULB SELECTION:

Searchlight Size Inches	Voltage	Approximate Range Miles*	Bulb Catalog Number	Bulb Wattage	Rated Life Hours**	Maximum Candlepower Output	Horizontal Beam Spread Degrees	Vertical Beam Spread Degrees
10"	12	1	816	100	50	1,168,000	1.7	1.4
	24	1	836	150	50	891,000	2.6	1.5
	32	3/4	817	200	200	571,000	2.6	1.7
	32	1	806	500	50	943,000	3.4	3.9
	120	1	820	600	75	908,000	4.4	2.2
	120	1-1/8	807	500	25	1,332,000	3.5	2.8
	120	1-1/8	844	500	500	1,260,000	3.1	3.4
12"	12	1-1/4	816	100	50	1,617,000	1.5	1.2
	24	1-1/8	836	150	50	1,349,000	2.2	1.5
	32	7/8	817	200	200	865,000	2.4	1.6
	32	1-1/8	806	500	50	1,496,000	3.4	3.5
	120	1	837	750	200	977,000	4.1	3.7
	120	1	845	750	200	1,185,000	3.7	5.2
	120	1-1/8	820	600	75	1,410,000	4.3	1.9
	120	1-1/4	809	750	25	1,792,000	3.6	3.4
	120	1-1/4	844	500	500	1,641,000	3.2	3.4
	120	1-1/4	807	500	25	1,799,000	3.3	3.1
	120	1-1/4	811	1000	50	1,816,000	4.0	4.9
	120	1-3/8	810	1000	25	1,894,000	4.0	3.8
	120	1-3/8	846	1000	200	1,911,000	3.9	5.0
	120	1-1/2	839	900	75	2,482,000	4.5	5.5
230	7/8	860	1000	25	865,000	6.9	5.9	
14"	12	1-1/4	816	100	50	1,756,000	1.5	1.0
	24	1-1/8	836	150	50	1,367,000	2.3	1.2
	32	1	817	200	200	943,000	2.2	1.5
	32	1-1/8	806	500	50	1,591,000	4.0	3.7
	120	1-1/8	837	750	200	1,254,000	3.9	4.5
	120	1-1/8	845	750	200	1,531,000	3.6	5.1
	120	1-1/4	820	600	75	1,626,000	4.5	1.9
	120	1-3/8	844	500	500	1,840,000	2.9	3.2
	120	1-3/8	811	1000	50	2,249,000	4.0	5.1
	120	1-1/2	807	500	25	2,353,000	3.2	3.2
	120	1-1/2	809	750	25	2,422,000	3.7	4.0
	120	1-1/2	846	1000	200	2,586,000	3.8	5.0
	120	1-1/2	810	1000	25	2,621,000	4.0	4.5
	120	1-5/8	839	900	75	2,889,000	4.5	5.2
	230	1	860	1000	50	1,021,000	7.7	6.2

*The approximate ranges listed above are based on photometric measurements of beam candlepower output under ideal conditions. Many factors such as atmospheric conditions, size and color of target, background, etc., may reduce effective range considerably; therefore, these figures are offered only as a guide to compare different bulb and voltage options.

**NOTE: These are the "Rated Average Laboratory Life in Hours" of the Bulb Manufacturer obtained in closely controlled laboratory life testing of groups of lamps at their design voltage. It is not necessarily the same as the service life where conditions such as shock, vibration, voltage fluctuation and environment may result in a shorter average attained life.



2-PIN PREFOCUS



MOGUL SCREW



MEDIUM PREFOCUS



MEDIUM SCREW

800 SERIES

- 1) **Head Assembly Type:** _____
 a) For deck control - 883
 b) For lever control - 884
 c) For wheel and lever/gear control - 885
- 2) **Pedestal (overall) Height (see catalog page for details):** _____
 a) Standard - O
 b) Medium - M
 c) High - H
For custom pedestal height see no. 10 below.
- 3) **Reflector Size:** _____
 a) 10 inch - 1
 b) 12 inch - 2
 c) 14 inch - 3
- 4) **Finish:** _____
 a) PERKOPLATE (polished chrome) - CHR
 b) PERKO*KOTE (white) - WHT
- 5) **Control Type:** _____
 a) Lever control (For 884 Head Assembly) - 851
 b) Wheel control (For 885 Head Assembly) - 852
 c) Lever/Gear control (For 885 Head Assembly) - 969
- 6) **Control Length (when necessary):** _____
 a) (8-1/2" for 851 & 969) or (7-1/2" for 852) - 0
 b) (15-1/2" for 851 & 969) or (14-1/2" for 852) - A
 c) (22-1/2" for 851 & 969) or (21-1/2" for 852) - B
 d) (29-1/2" for 851 & 969) or (28-1/2" for 852) - C
- 7) **Bulb Number (see pages 54 & 55 for details):** _____
- 8) **Socket Type:** Code: _____
 a) Medium Screw "B"
 b) Medium Prefocus "E"
 c) Mogul Screw "D" (Not for use with 10 inch reflector.)
 d) 2-Pin Prefocus (12 volt) "F"
 e) 2-Pin Prefocus (24 volt) "G"
 f) 2-Pin Prefocus (32 volt) "H"
 g) 2-Pin Prefocus (600 Watt) "I"
 h) 2-Pin Prefocus (900 watt) "K" (Not for use with 10 inch reflector.)
- 9) **Custom control length:** _____
 Specify control length desired as measured from pedestal base to lower end of control assembly ("E" or "F" dimension).
- 10) **Custom pedestal height:** _____
 Specify overall height of searchlight desired as measured from the top of the searchlight head to the bottom of the pedestal base ("J" dimension).

Head Assembly Cat. No.

Control Assembly Cat. No.

Bulb Cat. No.

Socket Code

SPARE PARTS

FOR 800 SERIES SOLAR-RAY® SEARCHLIGHTS

Fig.	Size	Front Glass Cat. No.	Front Door with Glass Cat. No.	Rear Cover Cat. No.	Reflector* Cat. No.	Pinion Gear Cat. No.
883	10"	889 001 CLR	891 001 CHR	908 001 CHR	890 001	----
	12"	889 002 CLR	891 002 CHR	908 002 CHR	890 002	----
	14"	889 003 CLR	891 003 CHR	908 003 CHR	890 003	----
884	10"	889 001 CLR	891 001 CHR	902 001 CHR	890 001	----
	12"	889 002 CLR	891 002 CHR	902 002 CHR	890 002	----
	14"	889 003 CLR	891 003 CHR	902 003 CHR	890 003	----
885 and 886	10"	889 001 CLR	891 001 CHR	902 001 CHR	890 001	905
	12"	889 002 CLR	891 002 CHR	902 002 CHR	890 002	905
	14"	889 003 CLR	891 003 CHR	902 003 CHR	890 003	905

NOTE: The Spare Part catalog numbers listed above are for the polished chrome (CHR) finish.

To order white finish, replace the "CHR" in the catalog number with the "WHT" finish code.

*Replacement Retaining Clips (Cat. No. 910) For The Reflector Should Also Be Ordered When Ordering a Replacement Reflector To Assure a Proper Fit.

19 INCH SOLAR-RAY® SEARCHLIGHT

1900 SERIES

ALL ALUMINUM - WHITE PERKO•KOTE FINISH 32, 120 OR 230 VOLTS

The 1900 Series - Solar-Ray® Searchlights are designed and built with the commercial user in mind where maximum size and brilliance counts. These units are constructed of marine aluminum with heavy duty castings and heavy gauge reinforced bodies for extra durability. They are finished in our white PERKO•KOTE finish; an advanced process that eliminates the need for painting while providing a scratch resistant and chip-proof surface for painting when necessary to match the color of the vessel.

The 1900 Series is available with Deck, Wheel or Lever/Gear Controls. All models feature halo deflectors, parabolic glass mirror reflectors for maximum light output and ventilation covers for quick dissipation of heat to help prolong bulb life. Hinged front doors have quick release stainless steel latches to provide easy access for bulb replacement.

Bulbs are not included and must be ordered separately. PERKO offers a choice of the traditional incandescent or the brighter, more piercing quartz-halogen bulbs in a variety of voltages and wattages. For complete information on bulbs and candlepower output, see page 59.

"1900 Series" High Power Searchlights Features

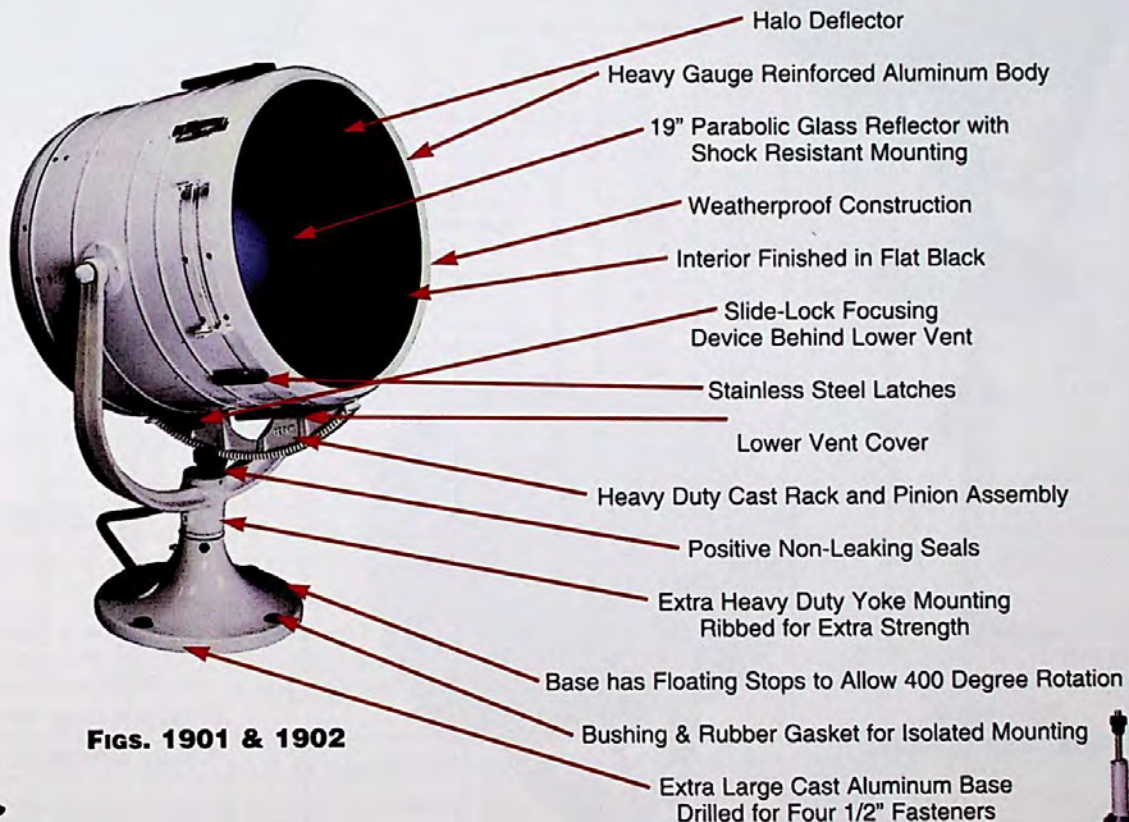

Figs. 1901 & 1902

CONTROL TYPES



FIG. 1922

WHEEL CONTROL

Turn upper wheel for horizontal position. Turn Lower Wheel for vertical position.

DECK CONTROL

Equipped with handles on the rear cover for positioning.

LEVER/GEAR CONTROL

Aim handle for horizontal position. Twist handle for vertical position.



FIG. 1921

19 INCH SOLAR-RAY® SEARCHLIGHTS

SEARCHLIGHT DIMENSIONS

Nominal Drum Diameter Inches	Nominal Drum Weight Pounds	Nominal Control Weight Pounds
19	68	22

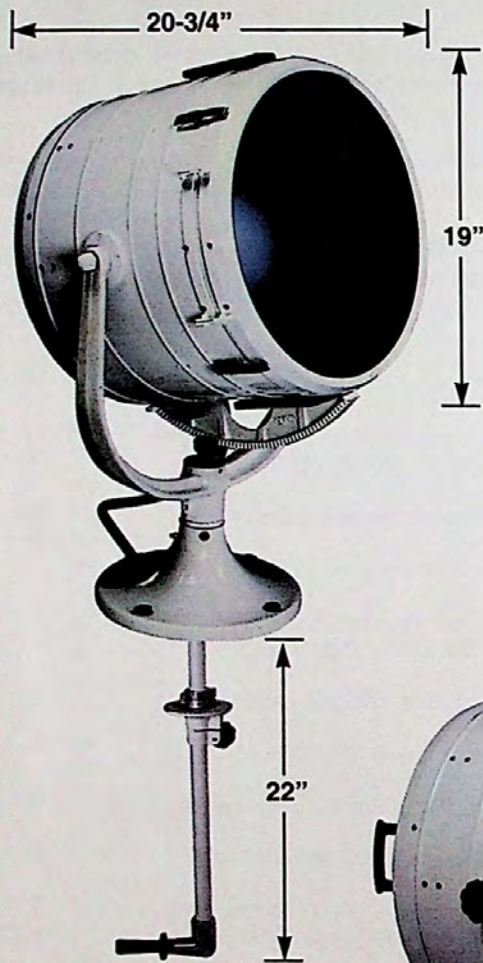

FIG. 1902
LEVER/GEAR CONTROL



FIG. 1901
DECK CONTROL

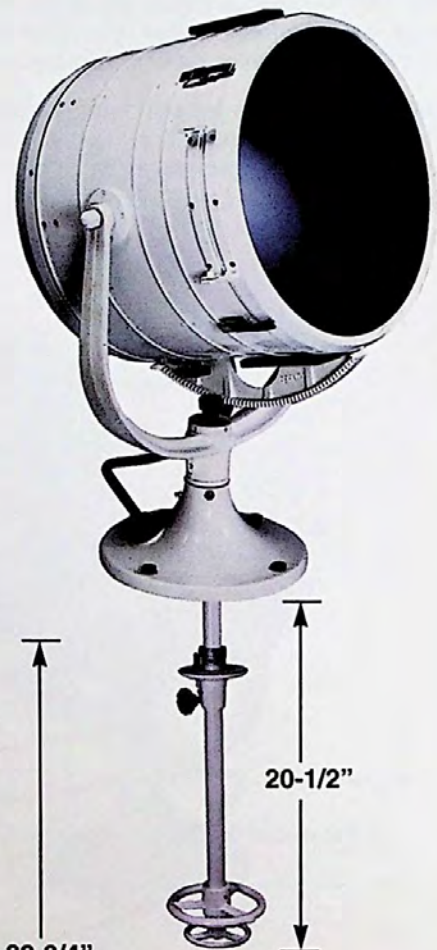

FIG. 1902
WHEEL CONTROL

Base Diameter, 13 Inches.
Distance Between Wheels, 2-1/2 Inches.

19 INCH SOLAR-RAY® SEARCHLIGHT HEAD AND CONTROL ASSEMBLIES

ALL ALUMINUM - WHITE PERKO•KOTE FINISH

ORDERING INFORMATION

Description	Catalog No.
Deck Control Searchlight Head Assembly*	1901 004 WHT
Wheel or Lever/Gear Control Searchlight Head Assembly (Requires Control Assembly Below)	1902 004 WHT
Wheel Control Assembly (For Above)	1922 000 WHT
Lever/Gear Control Assembly (For Above)	1921 000 WHT

*Cannot Be Fitted With Controls.

Custom Control Lengths and Pedestal Heights Are Available. Price Upon Application. Specify Measurements.

BULBS ARE NOT INCLUDED IN LIGHTS

BULB ORDERING INFORMATION FOR 19 INCH SEARCHLIGHTS

To give good results, the bulb and reflector must be perfectly compatible; therefore be sure to specify the catalog number of the bulb desired. Peak candlepower is exceedingly sensitive to many factors, (i.e., a light source out of focus by 1/32 inch, under-voltage of only 4%, or differences between bulb manufacturers can cause a reduction of range of up to 20%).

For a More Concentrated Beam, Longer Range, Brighter Light and a Longer Life, We Recommend the Quartz/Halogen Bulbs.

Voltage	Approx. Range Miles*	Bulb Catalog Number	Bulb Type	Socket Type	Socket Code Letter	Wattage	Rated Life Hours**	Maximum Candlepower Output	Horizontal Beam Spread Degrees	Vertical Beam Spread Degrees	Mfg. Bulb Code
32	1-2/3	806	Incandescent	Medium Screw	B	500	50	3,520,000	3.5	3.7	DLT
120	1-3/8	837	Incandescent	Medium Prefocus	E	750	200	2,076,000	3.6	4.2	DDY
120	1-5/8	845	Quartz/Halogen	Medium Prefocus	E	750	200	2,871,000	3.6	5.4	BTP
120	1-5/8	807	Incandescent	Medium Prefocus	E	500	25	3,191,000	3.5	4.0	CZX
120	1-2/3	859	Quartz/Halogen	Mogul Prefocus	M	2000	250	3,633,000	9.4	5.9	BVW
120	1-2/3	847	Quartz/Halogen	Mogul Prefocus	M	1000	200	3,659,000	4.5	5.4	BVV
120	1-3/4	844	Quartz/Halogen	Medium Prefocus	E	500	500	3,861,000	3.0	5.4	BTL
120	1-3/4	809	Incandescent	Medium Prefocus	E	750	25	4,569,000	3.6	4.5	DDB
120	1-7/8	846	Quartz/Halogen	Medium Prefocus	E	1000	200	4,601,000	4.5	5.4	BTR
120	2	848	Quartz/Halogen	Mogul Prefocus	L	1500	100	5,596,000	5.9	5.7	DTA
120	2	810	Incandescent	Medium Prefocus	E	1000	25	5,622,000	3.6	4.2	DRS
120	2	839	Quartz/Halogen	2-Pin Prefocus	K	900	75	5,769,000	5.9	5.4	BVA
120	2-1/8	840	Incandescent	Mogul Prefocus	L	1500	25	5,968,000	5.6	5.4	DTJ
230	1-3/8	860	Incandescent	Medium Prefocus	E	1000	50	2,162,000	7.9	6.5	DWK

*The approximate ranges listed above are based on photometric measurements of beam candlepower output under ideal conditions. Many factors such as atmospheric conditions, size and color of target, background, etc., may reduce effective range considerably; therefore, these figures are offered only as a guide to compare different bulb and voltage options.

PLEASE ORDER CAREFULLY, BULBS ARE NOT RETURNABLE.

**NOTE: These are the "Rated Average Laboratory Life in Hours" of the Bulb Manufacturer obtained in closely controlled laboratory life testing of groups of lamps at their design voltage. It is not necessarily the same as the service life where conditions such as shock, vibration, voltage fluctuation and environment may result in a shorter average attained life.

Electric Socket and Support Stand Assemblies for 19 Inch Searchlights

Solar-Ray® Searchlights include a socket and support stand based on the bulb or socket information given when ordering. The following chart makes it possible to order and stock different assemblies for field conversion, to meet a large variety of voltage and candlepower requirements with a minimum of inventory.

ORDERING INFORMATION

Socket Type	Socket Code	Socket & Stand Catalog Number	Height Stand Inches
Medium Screw	B	872 004	5-3/4
Medium Prefocus	E	873 004	5-7/16
Mogul Prefocus (1500 Watt)	L	1930 004	3-5/8
Mogul Prefocus (1000 & 2000 Watt)	M	1931 004	3-1/8
2-Pin Prefocus (900 Watt)	K	880 004	7-5/16

SPARE PARTS FOR 1900 SERIES SOLAR-RAY SEARCHLIGHTS

ORDERING INFORMATION

Fig. No.	Front Glass Cat. No.	Front Door with Glass Cat. No.	Rear Cover Cat. No.	Reflector* Cat. No.	Pinion Gear Cat. No.
1901	889 004 CLR	1936 000 WHT	1932 000 WHT	890 004	----
1902	889 004 CLR	1936 000 WHT	1933 000 WHT	890 004	905
1903	889 004 CLR	1936 000 WHT	1933 000 WHT	890 004	905

*Replacement Retaining Clips (Cat. No. 911) for the Reflector Should Also Be Ordered When Ordering a Replacement Reflector to Assure a Proper Fit.

SPARE SOCKETS FOR 800 SERIES AND 1900 SERIES SOLAR-RAY® SEARCHLIGHTS

ORDERING INFORMATION



Medium Screw Socket
(Code "B")
Catalog No. 894.



Medium Prefocus Socket
(Code "E")
Catalog No. 895.



2-Pin Prefocus Socket
(Codes "F, G, H & I"*)
Catalog No. 899.

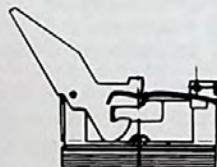

2-Pin Prefocus Socket
(Code "K"**)
Catalog No. 866.



Mogul Screw Socket
(Codes "D")
Catalog No. 897.

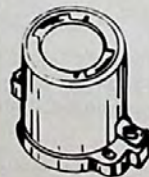

Mogul Prefocus Socket
(Codes "L & M")
Catalog No. 893.

*For Use In 10", 12" and 14" Searchlights Except When Catalog No. 839, 900 Watt Bulb is Used.

**For Use In 12", 14" and 19" Searchlights Only When the Catalog No. 839, 900 Watt Bulb is Used.

DOME LIGHTS

FIG. 300 - SURFACE MOUNT DOME LIGHT

**DOUBLE CONTACT BAYONET SOCKET
PUSH SWITCH WITH WATER RESISTANT BOOT
COMPLETE WITH 12 VOLT BULB.**

**CHROME PLATED ZINC
BLACK VINYL MOUNTING GASKET**

ORDERING INFORMATION

O.D. Globe Inches	O.D. Base Inches	Depth Overall Inches	Maximum Wattage	Display Pkg. - 5 Cards 1 Pc. per Card	OEM Bulk Pkg. 10 Pcs.	Screw Size	Weight Ounces
3	3-3/4	1-1/2	11	300 DP0 CHR	300 000 CHR*	10 R.H.	7
4	5	1-7/8	17	300 DP1 CHR	300 001 CHR	10 R.H.	9
5	6	2	17	300 DP2 CHR	300 002 CHR	12 R.H.	11

*OEM Bulk Pkg., 20 Pcs.

Spare Bulbs (2 per card) for 3 Inch Light, Cat. No. 337 011 DP.

Spare Bulbs (2 per card) for 4 Inch Light, Cat. No. 337 012 DP.

Spare Bulbs (2 per card) for 5 Inch Light, Cat. No. 337 013 DP.

Spare Switch, Cat. No. 701 DP.

Spare Socket, Cat. No. 24 DP1.

Spare Globe, Cat. No. 257 DP, Specify Size.



Fig. 300

FIG. 1253 - EXTERIOR DOME LIGHT

**DOUBLE CONTACT BAYONET SOCKET
PUSH SWITCH WITH WATER RESISTANT BOOT
COMPLETE WITH 12 VOLT BULB.**

**IVORY PERKO-KOTE POWDER COATING
BLACK VINYL MOUNTING GASKET**

ORDERING INFORMATION

O.D. Globe Inches	O.D. Base Inches	Depth Overall Inches	Maximum Wattage	Display Pkg. - 5 Cards 1 Pc. per Card	OEM Bulk Pkg. 10 Pcs.	Screw Size	Weight Ounces
4	5	1-7/8	17	1253 DP1 WHT	1253 001 WHT	10 R.H.	9
5	6	2	17	1253 DP2 WHT	1253 002 WHT	12 R.H.	11

Spare Bulbs (2 per card) for 4 Inch Light, Cat. No. 337 012 DP.

Spare Bulbs (2 per card) for 5 Inch Light, Cat. No. 337 013 DP.

Spare Switch, Cat. No. 701 DP.

Spare Socket, Cat. No. 24 DP1.

Spare Globe, Cat. No. 257 DP, Specify Size.



Fig. 1253

FIG. 1258 - SURFACE MOUNT DOME LIGHT

**PUSH SWITCH WITH WATER RESISTANT BOOT
COMPLETE WITH 12 VOLT, 10 WATT BULB.**

WHITE TRANSLUCENT PLASTIC GLOBE

CHROME PLATED ZINC

ORDERING INFORMATION

O.D. Base Inches	Depth Overall Inches	Maximum Wattage	Display Pkg. - 5 Cards 1 Pc. per Card	OEM Bulk Pkg. 10 Pcs.	Screw Size	Weight Ounces
3-3/4	1-1/4	10	1258 DP2 CHR	1258 002 CHR	8 R.H.	7

Spare Bulbs (2 per card), Cat. No. 70 DP0 CLR. Spare Switch, Cat. No. 701 DP.

Spare Globe, Cat. No. 244 002 WHT.



Fig. 1258

NOTE: TO USE THE LIGHT ABOVE IN A 24 VOLT SYSTEM, ORDER REPLACEMENT BULBS (2 PER CARD) CAT. No. 67 DP1 CLR.

DOME LIGHTS



FIG. 1260 - SURFACE MOUNT DOME LIGHT

**PUSH SWITCH WITH WATER RESISTANT BOOT
COMPLETE WITH 12 VOLT, 10 WATT BULB.
WHITE TRANSLUCENT PLASTIC GLOBE
CHROME PLATED ZINC**



Fig. 1260

ORDERING INFORMATION

Dimensions Base Inches	Depth Overall Inches	Maximum Wattage	Display Pkg. - 5 Cards 1 Pc. per Card	OEM Bulk Pkg. 10 Pcs.	Screw Size	Weight Ounces
3-5/8 x 4-1/4	1-1/4	10	1260 DP2 CHR	1260 002 CHR	8 R.H.	10
Spare Bulbs (2 per card), Cat. No. 70 DP0 CLR.			Spare Switch, Cat. No. 701 DP.			
Spare Globe, Cat. No. 245 002 WHT.						

NOTE: TO USE THE LIGHT ABOVE IN A 24 VOLT SYSTEM, ORDER REPLACEMENT BULBS (2 PER CARD) CAT. No. 67 DP1 CLR.

FIG. 753 - SURFACE MOUNT DOME LIGHT

**FOR SYSTEMS UP TO 50 VOLTS.
MEDIUM SCREW SOCKET, TOGGLE SWITCHES
BULBS NOT INCLUDED**

**SIZE NO. 1 HAS ONE SOCKET AND SWITCH.
WILL ACCOMMODATE A BULB UP TO 50 WATTS.**

**SIZE NO. 2 HAS TWO SOCKETS AND SWITCHES.
WILL ACCOMMODATE BULBS UP TO 25 WATTS.**

CHROME PLATED WROUGHT BRASS



Fig. 753

ORDERING INFORMATION

O.D. Glass Inches	O.D. Base Inches	Depth Inches	Standard Pkg. - 1 Pc.	Screw Size	Weight Pounds
8	9-1/2	3	753 001 CHR	10 R.H.	2-1/2
8	9-1/2	3	753 002 CHR	10 R.H.	2-3/4

Spare Switch, Cat. No. 514 DP.
Spare Socket, Cat. No. 1323.
Spare Globe, Cat. No. 132 000 FRD.

DOME LIGHTS

FIG. 555 - SURFACE MOUNT DOME LIGHT

**FOR SYSTEMS UP TO 50 VOLTS.
TWIN DOUBLE CONTACT BAYONET SOCKETS,
TOGGLE SWITCH. BULBS NOT INCLUDED.
WILL ACCOMMODATE BULBS UP TO 20 WATTS EACH.**

CHROME PLATED BRONZE



FIG. 555

ORDERING INFORMATION

O.D. Globe Inches	O.D. Base Inches	Depth Inches	Standard Pkg. - 1 Pc.	Screw Size	Weight Pounds
6	7-7/8	3-1/8	555 000 CHR	8	4-1/2

Spare Switch, Cat. No. 514 DP.
Spare Socket, Cat. No. 1323.
Spare Globe, Cat. No. 257 DP6.

FIG. 318 - SURFACE MOUNT LIGHT



**DUAL VOLTAGE, FOR 12 AND 120 VOLTS
DOUBLE CONTACT BAYONET SOCKETS,
COMPLETE WITH TWO 12 VOLT AND TWO 120 VOLTS BULBS.**

**WHITE TRANSLUCENT PLASTIC GLOBE
WHITE PERKO-KOTE CAST ZINC BASE
WITH INTEGRAL JUNCTION BOX**



FIG. 318

ORDERING INFORMATION

Length Inches	Width Inches	Depth Inches	Display Pkg. - 5 Cards 1 Pc. per Card	OEM Bulk Pkg. 10 Pcs.	Screw Size	Weight Pounds
9-3/4	3-1/2	1-7/8	318 DP	318 A00	10	1-5/8

Spare 12 Volt Bulbs (2 per card), Cat. No. 337 012 DP. Spare Socket, Cat. No. 24 DP1.
Spare 120 Volt Bulbs (2 per card), Cat. No. 337 023 DP. Spare Globe, Cat. No. 318 A00 99D.
Spare Switches with Square Buttons (1 Each High and Low), Cat. No. 318 A00 99E.

UTILITY LIGHTS



FIG. 1254

FIG. 1254 - ADJUSTABLE UTILITY LIGHT

SHIELD SWIVELS TO CHANGE POSITION

COMPLETE WITH 12 VOLT, 7 WATT BULB.

CHROME PLATED ZINC

ORDERING INFORMATION

O.D. Overall Inches	Length Neck Inches	O.D. Neck Inches	Display Pkg. - 5 Cards 1 Pc. per Card	Screw Size	Weight Ounces
2-5/8	3/4	7/8	1254 DP CHR	6	6

Spare Bulbs (2 per card), Cat. No. 337 011 DP.
Spare Socket, Cat. No. 24 DP1.



FIG. 137 - SURFACE MOUNT UTILITY LIGHT, COMPLETE WITH 12 VOLT, 1 WATT BULB, SHIELDED LIGHT COVER, MOLDED BLACK PLASTIC

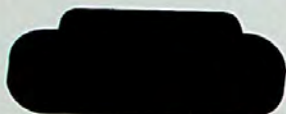

FIG. 137

FIG. 140 - SURFACE MOUNT UTILITY LIGHT, COMPLETE WITH 12 VOLT, 1 WATT BULB, DIFFUSED LIGHT COVER, MOLDED WHITE PLASTIC



FIG. 140

ORDERING INFORMATION

Dimensions Inches	Display Pkg. - 10 Cards 1 Pc. per Card	OEM Bulk Pkg. 100 Pcs.	Screw Size	Weight Ounces
1-3/8 x 5/8	137 DP BLK	137 000 BLK	6 R.H.	1/2
1-3/8 x 5/8	140 DP NYN	140 000 NYN	6 R.H.	1/2

FIGS. 1087 & 1090 - VAPOR PROOF LIGHT FIXTURES

**SATIN FINISH DIE CAST ALUMINUM WITH GLASS GLOBES.
INTEGRAL JUNCTION BOX WITH FOUR 1/2 INCH I.P.S. FITTINGS.**



FIG. 1090



FIG. 1087

**FIG. 1087, CEILING MOUNT
FIG. 1090, BULKHEAD MOUNT**

**MEDIUM SCREW SOCKET FOR BULBS UP TO 100 WATTS.
BULB NOT INCLUDED.**

ORDERING INFORMATION

O.D. Box Inches	Length Overall Inches	Projection Inches	Standard Pkg. - 1 Pc.	Bolt Size	Weight Pounds
3-3/4	9-1/2	---	1087 000 ALU	1/4	3
3-3/4	10	7	1090 000 ALU	1/4	3-1/4



**LISTED BY
UNDERWRITERS
LABORATORIES**

Note: These Fixtures are listed in accordance with U.L. Standard 57, for enclosed gasketed fixtures.
Not evaluated for use in hazardous or explosive atmospheres.

Spare Guards, Cat. Nos. 1087 000 99A and 1090 000 99A.
Spare Sockets, Cat. Nos. 1087 000 99B and 1090 000 99B.

Spare Globes, Cat. Nos. 1087 000 99C and 1090 000 99C.

UTILITY LIGHTS

FIG. 1044 - FLUSH UTILITY LIGHT

NO. 1 SUPPLIED WITH 1/4" SPADE CONNECTORS
NO. 2 SUPPLIED WITH 7" WIRE LEADS

COMPLETE WITH 12 VOLT, 3 WATT BULB.

SNAP-ON FRONT COVER CONCEALS MOUNTING SCREWS.

MOLDED PLASTIC, BLACK OR WHITE WITH DIFFUSION LENS.

INSTALLS IN A 1-3/4" DIAMETER HOLE.



Pig Tail Leads
(#2 Style)



Spade Connectors
(#1 Style)



Fig. 1044



ORDERING INFORMATION

Color	Dimensions Inches	Depth Inches	Display Pkg. - 10 Cards 1 Pc. per Card	OEM Bulk Pkg. 100 Pcs.	Weight Ounces
Black	2-1/4 x 2-1/4	15/16	1044 DP1 BLK	1044 001 BLK	1
Black	2-1/4 x 2-1/4	15/16	1044 DP2 BLK	1044 002 BLK	1
White	2-1/4 x 2-1/4	15/16	1044 DP1 WHT	1044 001 WHT	1
White	2-1/4 x 2-1/4	15/16	1044 DP2 WHT	1044 002 WHT	1

Screw Size, No. 6.

Spare Bulb, Cat. No. 1044 000 99A.

FIG. 1064 - FLUSH UTILITY LIGHT

NO. 1 SUPPLIED WITH 1/4" SPADE CONNECTORS

NO. 2 SUPPLIED WITH 7" WIRE LEADS

COMPLETE WITH 12 VOLT, 3 WATT BULB.

MOLDED PLASTIC, BLACK OR WHITE WITH DIFFUSION LENS.

INSTALLS IN A 1-3/4" DIAMETER HOLE.



Pig Tail Leads
(#2 Style)



Spade Connectors
(#1 Style)



Fig. 1064



ORDERING INFORMATION

Color	Dimensions Inches	Depth Inches	Display Pkg. - 10 Cards 1 Pc. per Card	OEM Bulk Pkg. 100 Pcs.	Weight Ounces
Black	2-1/4 x 2-1/4	15/16	1064 DP1 BLK	1064 001 BLK	1
Black	2-1/4 x 2-1/4	15/16	1064 DP2 BLK	1064 002 BLK	1
White	2-1/4 x 2-1/4	15/16	1064 DP1 WHT	1064 001 WHT	1
White	2-1/4 x 2-1/4	15/16	1064 DP2 WHT	1064 002 WHT	1

Screw Size, No. 6.

Spare Bulb, Cat. No. 1044 000 99A.

FIG. 1146 - "REDUCED GLARE" DESIGN COCKPIT LIGHT

CHROME PLATED BRASS WITH BLACK PLASTIC BASE
COMPLETE WITH 12 VOLT BULB.

DESIGNED TO DIRECT 80% OF THE LIGHT DOWNWARD,
THUS REDUCING COCKPIT GLARE.

INSTALLS IN A 2-1/8" DIAMETER HOLE.



Fig. 1146

ORDERING INFORMATION

O.D. Overall Inches	Depth Inches	Display Pkg. - 5 Cards 1 Pc. per Card	OEM Bulk Package 25 Pcs.	Screw Size	Weight Ounces
3	1	1146 DP1 12V	1146 001 12V	8	4

Spare 12 Volt Bulbs (2 Per Card), Cat. No. 70 DP0 CLR.
 Spare Lens with Gasket, Cat. No. 1146 DP 99A.

Spare 12 Volt Socket Assembly, Cat. No. 946 DP1 99B.
 Spare Mounting Flange, Cat. No. 946 000 99C

SPREADER LIGHTS



FIG. 1040 - ADJUSTABLE SPREADER LIGHT

COMPLETE WITH 12 VOLT, 24 OR 32 VOLT SEALED BEAM UNIT.

MOLDED BLACK PLASTIC BODY
CHROME PLATED BRASS MOUNTING BRACKET



Fig. 1040

ORDERING INFORMATION

Voltage	Dimensions			Display Pkg. 1 Pc. per Card	Cards per Pkg.	OEM Bulk Pkg. 10 Pcs.	Weight Pounds
	O.D. Inches	Depth Inches	Bracket Inches				
12	4-1/2	4-1/2	4-1/2 x 1	1040 DP1 12V	5	1040 001 12V	1-1/2
24	4-1/2	4-1/2	4-1/2 x 1	1040 DP2 24V	2	1040 002 24V	1-1/2
32	4-1/2	4-1/2	4-1/2 x 1	1040 DP3 32V	2	1040 003 32V	1-1/2

Screw Size, No. 12 R.H.

Spare Sealed Beam Unit (12 Volt), Cat. No. 432 001 12V.

Spare Sealed Beam Unit (24 Volt), Cat. No. 432 002 24V.

Spare Sealed Beam Unit (32 Volt), Cat. No. 432 003 32V.



FIG. 280 - ADJUSTABLE SPREADER LIGHT

COMPLETE WITH 12 VOLT, 24 OR 32 VOLT SEALED BEAM UNIT.

CHROME PLATED BRASS



Fig. 280

ORDERING INFORMATION

Voltage	Dimensions			Display Pkg. 1 Pc. per Card	Cards per Pkg.	OEM Bulk Pkg. 10 Pcs.	Weight Pounds
	O.D. Inches	Depth Inches	Bracket Inches				
12	4-5/8	2-1/2	5-3/8 x 3/4	280 DP1 12V	5	280 001 12V	1-1/8
24	4-5/8	2-1/2	5-3/8 x 3/4	280 DP2 24V	2	280 002 24V	1-1/8
32	4-5/8	2-1/2	5-3/8 x 3/4	280 DP3 32V	2	280 003 32V	1-1/8

Screw Size, No. 12 R.H.

Spare Sealed Beam Unit (12 Volt), Cat. No. 432 001 12V.

Spare Sealed Beam Unit (24 Volt), Cat. No. 432 002 24V.

Spare Sealed Beam Unit (32 Volt), Cat. No. 432 003 32V.



FIG. 265 - FIXED SPREADER LIGHT

COMPLETE WITH 12 VOLT, 10 WATT BULB

CHROME PLATED BRONZE



Fig. 265

ORDERING INFORMATION

O.D. Inches	Depth Inches	Display Pkg. - 5 Pcs. 1 Pc. per Pkg.	OEM Bulk Pkg. 10 Pcs.	Screw Size	Weight Ounces
2-3/4	1-3/8	265 DP CHR	265 000 CHR	6	5

Spare Bulbs (2 per card), Cat. No. 70 DP0 CLR.

Spare Socket Assembly, Cat. No. 265 000 99A.

Spare Lens with O-Ring, Cat. No. 284 DP CLR.

BULKHEAD LIGHTS

FIG. 217 - BULKHEAD LIGHT FIXTURES

**FOR SYSTEMS UP TO 50 VOLTS.
MEDIUM SCREW SOCKET, TURN SWITCH**

CHROME PLATED ZINC

ORDERING INFORMATION

Dimensions Base Inches	Projection Less Lamp Inches	Display Pkg. - 5 Cards 1 Pc. per Card	Screw Size	Weight Ounces
2-1/2 x 1-3/4	2-5/8	217 DP CHR	6 R.H.	8

Spare Bulb Socket with Switch, Cat. No. 223.



FIG. 217

FIG. 450 - BULKHEAD LIGHT FIXTURES

**FOR SYSTEMS UP TO 50 VOLTS.
MEDIUM SCREW SOCKET, TURN SWITCH
BULB NOT INCLUDED**

**CAST BRONZE
POLISHED OR CHROME PLATED**

ORDERING INFORMATION

Dimensions Base Inches	Projection Less Lamp Inches.	Chrome Plated Bronze Display Pkg. - 5 Pcs.	Screw Size	Weight Ounces
2-1/2 x 2-1/2	2-1/2	450 DP CHR	8 R.H.	11

Spare Bulb Socket with Switch, Cat. No. 223.



FIG. 450

FIG. 1303 - BULKHEAD LIGHT FIXTURES

FOR SYSTEMS UP TO 50 VOLTS.

**SIZE NO. 1 HAS DOUBLE CONTACT BAYONET SOCKET.
WILL ACCOMMODATE A BULB UP TO 24 WATTS.**

**SIZE NO. 2 HAS MEDIUM SCREW SOCKET.
WILL ACCOMMODATE A BULB UP TO 40 WATTS.**

MOLDED PLASTIC, BLACK OR WHITE

ORDERING INFORMATION

Dimensions Wall Plated Inches	Normal Projection Inches	Length Shade Inches	Black	White	Screw Size	Weight Ounces
			Std. Pkg. - 1 Pc. OEM Pkg. - 50 Pcs.	Std. Pkg. - 1 Pc. OEM Pkg. - 50 Pcs.		
4-1/2 x 3-1/4	4-3/8	3	1303 001 BLK	1303 001 WHT	8	3
4-1/2 x 3-1/4	5	4-1/2	1303 002 BLK	1303 002 WHT	8	5

Spare Switch, Cat. No. 701 DP.



FIG. 1303

JANUARY 31, 1977 THE U.S.C.G. PUBLISHED SAFETY STANDARDS FOR MARINE ELECTRICAL SYSTEMS. THESE STANDARDS COVER SUCH TECHNICAL DETAILS AS:

- **BATTERIES AND ASSOCIATED CONDUCTORS**

- **CONDUCTOR SIZE AND AMPACITY**

- **STRAIN RELIEF AND PULL TESTS**

- **TERMINATION REQUIREMENTS**

- **OVERCURRENT PROTECTION**

- **IGNITION PROTECTION**

- **GROUNDING**

- **INSULATION**

A particular electrical component may be affected by some or all of the above categories. Those categories related to product design have been complied with, however, many additional details must be considered by the installer of the equipment as well in order to achieve compliance with this standard. It is suggested that the actual standard be familiarized when installing equipment. Perhaps one of the most critical requirements is ignition protection. A product that is marked "Ignition Protected" can be used in that area of a boat that is not isolated from a gasoline fuel vapor source. Refer to the actual standard for a determination of what parts of a boat require Ignition Protected products. If a product is not plainly marked "Ignition Protected" then assume it is not.

**FOR DETAILS ON ALL OF THE ABOVE, OBTAIN THE FOLLOWING:
U.S.C.G. SAFETY STANDARDS FOR ELECTRICAL SYSTEMS
CFR TITLE 33, CHAPTER 1, SUBCHAPTER S, PART 183, SUBPART I.**

BATTERY SELECTOR SWITCHES



IGNITION PROTECTED

STANDARD FEATURES INCLUDE A MAKE BEFORE BREAK DESIGN, FOR USE WITH TWO OR MORE BATTERIES AND SINGLE OR DUAL ENGINE SYSTEMS*. THEY PERMIT SELECTION BETWEEN BATTERIES FOR STARTING AND CHARGING OR OPERATION OF BOTH BATTERIES IN PARALLEL. THEY ALLOW THE ADDITION OF AN EXTRA BATTERY FOR USE WITH ACCESSORIES. THE "OFF" POSITION ALSO ACTS AS AN EMERGENCY DISCONNECT IN THE EVENT OF AN ELECTRICAL PROBLEM. IN ADDITION SOME MODELS OFFER UNIQUE OPTIONS SUCH AS A KEYLOCK FOR EXTRA THEFT PROTECTION.

PROTECTED BY THE FOLLOWING U.S. PATENTS; DESIGN 260,637 - 4,280,028 - 4,424,424

SURFACE MOUNT, RED PLASTIC HOUSING WITH LARGE BLACK PLASTIC KNOB. INCORPORATES AN IMPROVED DESIGN TO PROTECT THE COPPER CONTACTS AND BRASS TERMINALS USED AS ELECTRICAL CONNECTIONS.

**FOR USE WITH SYSTEMS UNDER 50 VOLTS.
CAPACITY - 250 AMPS CONTINUOUS, 360 AMPS INTERMITTENT.**

ORDERING INFORMATION

Features:	Display Pkg. - 5 Pkgs. 1 Pc. per Pkg.	OEM Bulk Pkg. 25 Pcs.	Diameter Inches	Depth Inches	Weight Pounds
Standard	8501 DP	8501	5-1/4	2-5/8	1
With Keylock	8502 DP	8502	5-1/4	2-5/8	1



Fig. 8501



Fig. 8502

*For Dual Engine Systems, two switches are required.

ALTERNATOR FIELD DISCONNECT MODELS



IN ADDITION TO THE STANDARD FEATURES LISTED ABOVE THE ADVANTAGE THESE MODELS FEATURE IS THAT THEY WILL PREVENT DAMAGE TO THE ALTERNATOR* IF ACCIDENTALLY SWITCHED TO THE "OFF" POSITION WHILE THE ENGINE IS RUNNING.

ORDERING INFORMATION

Features:	Display Pkg. - 5 Pkgs. 1 Pc. per Pkg.	OEM Bulk Pkg. 25 Pcs.	Diameter Inches	Depth Inches	Weight Pounds
Standard	8503 DP	8503	5-1/4	2-5/8	1
With Keylock	8504 DP	8504	5-1/4	2-5/8	1



Fig. 8503



Fig. 8504

*When used with Non-Unitized Alternators, these models will interrupt the field current (reducing the possibility of damage) if turned "OFF" with the engine running.

MAIN BATTERY SWITCHES



IGNITION PROTECTED

THESE UNITS ARE THE SAME BASIC DESIGN AND CONSTRUCTION AS OUR 8500 SERIES, EXCEPT THEY ARE OFFERED AS MAIN DISCONNECT SWITCHES.

FOR USE WITH SYSTEMS UNDER 50 VOLTS.
CAPACITY - 250 AMPS CONTINUOUS, 360 AMPS INTERMITTENT.

PROTECTED BY THE FOLLOWING U.S. PATENTS; DESIGN 260,637 - 4,280,028 - 4,424,424

ORDERING INFORMATION

Features:	Display Pkg. - 5 Pkgs. 1 Pc. per Pkg.	OEM Bulk Pkg. 25 Pcs.	Diameter Inches	Depth Inches	Weight Pounds
Standard	9601 DP	9601	5-1/4	2-5/8	1
With Keylock	9602 DP	9602	5-1/4	2-5/8	1



Fig. 9601



Fig. 9602



ALTERNATOR FIELD DISCONNECT MODELS

IN ADDITION TO THE STANDARD FEATURES THE ADVANTAGE THESE MODELS FEATURE IS THAT THEY WILL PREVENT DAMAGE TO THE ALTERNATOR* IF ACCIDENTALLY SWITCHED TO THE "OFF" POSITION WHILE THE ENGINE IS RUNNING.

ORDERING INFORMATION

Features:	Display Pkg. - 5 Pkgs. 1 Pc. per Pkg.	OEM Bulk Pkg. 25 Pcs.	Diameter Inches	Depth Inches	Weight Pounds
Standard	9603 DP	9603	5-1/4	2-5/8	1
With Keylock	9604 DP	9604	5-1/4	2-5/8	1



Fig. 9603



Fig. 9604

*When used with Non-Unitized Alternators, these models will interrupt the field current (reducing the possibility of damage) if turned "OFF" with the engine running.

BATTERY SELECTOR SWITCHES

FIG. 8603 - HEAVY DUTY BATTERY SELECTOR SWITCH



IGNITION PROTECTED

MAKE BEFORE BREAK DESIGN, FOR USE WITH TWO OR MORE BATTERIES AND SINGLE OR DUAL ENGINES. ALTERNATOR FIELD DISCONNECT TO PREVENT DAMAGE TO ALTERNATOR IF ACCIDENTALLY SWITCHED TO THE "OFF" POSITION WHILE ENGINE IS RUNNING.

FIBER-REINFORCED POLYCARBONATE BODY 1/2 INCH DIAMETER BRASS BATTERY TERMINALS FOR USE WITH SYSTEMS UNDER 50 VOLTS.

CAPACITY - RATED 380 AMPS CONTINUOUS, 850 AMPS INTERMITTENT (5 MINUTES ON, 5 MINUTES OFF).

ORDERING INFORMATION

Dimensions				
Face	Depth	Display Pkg. - 2 Pkgs.	Weight	
Inches	Inches	1 Pc. per Pkg.	Pounds	
5-1/4 x 5-1/4	3-3/8	8603 DP	3	



FIG. 8603

FIG. 9703 - HEAVY DUTY BATTERY DISCONNECT SWITCH



IGNITION PROTECTED

THIS UNIT IS THE SAME BASIC DESIGN AND CONSTRUCTION AS OUR 8603 SERIES, EXCEPT IT IS OFFERED AS A MAIN DISCONNECT SWITCH WITH A HIGHER CAPACITY RATING.

FOR USE WITH SYSTEMS UNDER 50 VOLTS.

CAPACITY - RATED 450 AMPS CONTINUOUS, 1200 AMPS INTERMITTENT (15 SECONDS ON, 5 MINUTES OFF).



ORDERING INFORMATION

Dimensions				
Face	Depth	Display Pkg. - 2 Pkgs.	Weight	
Inches	Inches	1 Pc. per Pkg.	Pounds	
5-1/4 x 5-1/4	3-3/8	9703 DP	3-1/4	



FIG. 9703

SWITCHES



Fig. 310

FIG. 310 - IGNITION STARTER SWITCH

**3 POSITION: OFF-IGNITION/RUN-START.
RATED FOR 15 AMPS AT 12, 24 AND 32 VOLTS.
AUTOMATICALLY RETURNS FROM START TO RUN POSITION.
CHROME PLATED BRASS FACE NUT WITH PLAIN BRASS BODY**

ORDERING INFORMATION

For Maximum Dash Thickness Inches	Diameter Neck Inches	Length Overall Inches	Display Pkg. - 10 Cards 1 Pc. per Card	Weight Ounces
1	13/16	2-3/4	310 DP CHR	4-1/2



Fig. 105

FIG. 105 - PUSH-PULL SWITCH

**2 POSITION: OFF-ON.
RATED FOR 15 AMPS AT 12, 24 AND 32 VOLTS.
CHROME PLATED BRASS FACE NUT AND PLASTIC KNOB
WITH PLAIN BRASS BODY**

ORDERING INFORMATION

For Maximum Dash Thickness Inches	Diameter Neck Inches	Length Overall Inches	Display Pkg. - 10 Cards 1 Pc. per Card	OEM Bulk Pkg. 50 Pcs.	Weight Ounces
1	3/8	3	105 DP1 CHR	105 001 CHR	2-1/2



Fig. 366

FIG. 366 - PUSH-PULL SWITCH

**3 POSITION: 2 CIRCUIT, OFF-ON-ON.
RATED FOR 15 AMPS AT 12, 24 AND 32 VOLTS.**
For use with Combination Masthead/All-Round Lights together with Running Lights. Second "On" Position turns off Running Lights and turns on both compartments of Masthead/All-Round Light.

**CHROME PLATED BRASS FACE NUT AND PLASTIC KNOB
WITH PLAIN BRASS BODY**

ORDERING INFORMATION

For Maximum Dash Thickness Inches	Diameter Neck Inches	Length Overall Inches	Display Pkg. - 10 Cards 1 Pc. per Card	Weight Ounces
1	3/8	3-3/4	366 DP CHR	3-1/4



Fig. 381

FIG. 381- PUSH-PULL SWITCH

**3 POSITION: OFF-ON-ON.
RATED FOR 15 AMPS AT 12, 24 AND 32 VOLTS.**

First "On" Position Energizes One Terminal
Second "On" Position Energizes Both Terminals

**CHROME PLATED BRASS FACE NUT AND PLASTIC KNOB
WITH PLAIN BRASS BODY**

ORDERING INFORMATION

For Maximum Dash Thickness Inches	Diameter Neck Inches	Length Overall Inches	Display Pkg. - 10 Cards 1 Pc. per Card	Weight Ounces
1	3/8	3-3/4	381 DP CHR	3-1/4

Important Note: None of the above Switches are Ignition Protected. See Page 76.

SWITCHES

FIG. 255 - MOMENTARY SWITCH

**SINGLE POLE.
RATED FOR 15 AMPS AT 12, 24 AND 32 VOLTS.
CHROME PLATED BRASS BUTTON AND FACE NUT
WITH PLAIN BRASS BODY**

ORDERING INFORMATION

For Maximum Dash Thickness Inches	Diameter Neck Inches	Length Overall Inches	Display Pkg. - 10 Cards 1 Pc. per Card	OEM Bulk Pkg. 50 Pcs.	Weight Ounces
7/8	5/8	2-3/4	255 DP CHR	255 000 CHR	2-1/2



Fig. 255



FIG. 306 - MOMENTARY SWITCH

**SINGLE POLE.
RATED FOR 15 AMPS AT 12, 24 AND 32 VOLTS.
CHROME PLATED BRASS BUTTON WITH WEATHER
RESISTANT COVER AND PLAIN BRASS BODY**

ORDERING INFORMATION

For Maximum Dash Thickness Inches	Diameter Neck Inches	Length Overall Inches	Display Pkg. - 10 Cards 1 Pc. per Card	OEM Bulk Pkg. 50 Pcs.	Weight Ounces
1	5/8	2-3/4	306 DP CHR	306 000 CHR	3



Fig. 306



FIG. 701 - PUSH BUTTON SWITCH

**PUSH-ON, PUSH-OFF.
RATED FOR 10 AMPS AT 12, 24 AND 32 VOLTS.
BLACK PLASTIC WITH WEATHER RESISTANT COVER**

ORDERING INFORMATION

Maximum Thickness of Panel	Diameter Neck Inches	Display Pkg. - 10 Cards 1 Pc. per Card	Weight Ounces
1/8	3/8	701 DP	1/2



Fig. 701



Important Note: None of the above Switches are Ignition Protected. See Page 76.



Fig. 514

FIG. 514 - TOGGLE SWITCH
SINGLE POLE, SINGLE THROW (OFF-ON).
RATED FOR 6 AMPS AT 12, 24 AND 32 VOLTS.

NICKEL PLATED BRASS TOGGLE WITH
CHROME PLATED FACE NUT

ORDERING INFORMATION

Maximum Thickness of Panel Inches	Diameter Neck Inches	Display Pkg. - 10 Cards 1 Pc. per Card	Weight Ounces
5/16	7/16	514 DP	3/4



Fig. 688

FIG. 688 - TOGGLE SWITCH
SINGLE POLE, SINGLE THROW (OFF-ON).
RATED FOR 20 AMPS AT 12, 24 AND 32 VOLTS.

NICKEL PLATED BRASS TOGGLE WITH
CHROME PLATED FACE NUT

ORDERING INFORMATION

Maximum Thickness of Panel Inches	Diameter Neck Inches	Display Pkg. - 10 Cards 1 Pc. per Card	Weight Ounces
3/16	7/16	688 DP NKL	1

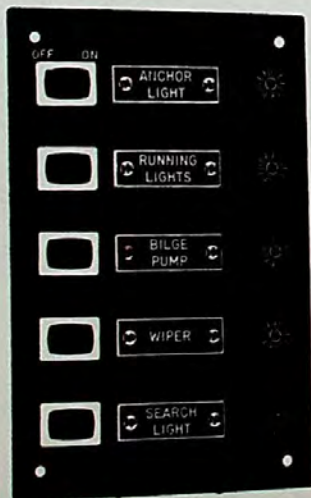

Fig. 517

FIG. 517 - SWITCH PANEL

BLACK PLASTIC

RATED FOR 10 AMPS AT 12, 24 AND 32 VOLTS.
COMPLETE WITH ROCKER SWITCHES,
NAME PLATES AND LOW PROFILE
FUSE HOLDERS FOR 1/4" X 1-1/4" FUSES.

WILL MOUNT ON CURVED OR FLAT SURFACES,
TEXTURED FINISH,
ENGRAVED LETTERING

ORDERING INFORMATION

Dimensions Inches	Display Pkg. - 5 Cards 1 Pc. per Card	Weight Ounces
6-1/2 x 4-1/2	517 DP BLK	8
Screw Size #6		

Spare Rocker Switches, Cat. No. 531 DP.
 Spare Fuse Holder Cap, Cat. No. 558 DP.
 Spare Fuse Holders, Cat. No. 532 DP.

Important Note: None of the above Switches are Ignition Protected. See Page 76.

FUSE PANELS

FIG. 626 - FUSE PANELS

**RATED FOR 20 AMPS AT 12, 24 AND 32 VOLTS.
FOR 1/4" x 1-1/4" FUSES**

MOLDED PLASTIC BASE WITH BRASS HARDWARE

ORDERING INFORMATION

Number of Gangs	Display Pkg. - 5 Bags 1 Pc. per Bag	Dimensions Inches	Weight Ounces
3	626 003 DP	2-1/4 x 2-7/16 x 3/16	2
4	626 004 DP	3 x 2-7/16 x 3/16	2-1/4
5	626 005 DP	3-3/4 x 2-7/16 x 3/16	2-1/2
6	626 006 DP	4-1/2 x 2-7/16 x 3/16	2-3/4



FIG. 626

FIG. 629 - FUSE PANELS

**RATED FOR 20 AMPS AT 12, 24 AND 32 VOLTS.
FOR 1/4" x 1-1/4" FUSES**

**SINGLE BUS BAR
MOLDED PLASTIC BASE WITH BRASS HARDWARE**

ORDERING INFORMATION

Number of Gangs	Display Pkg. - 5 Bags 1 Pc. per Bag	Dimensions Inches	Weight Ounces
4	629 004 DP	3 x 2-7/16 x 3/16	2
6	629 006 DP	4-1/2 x 2-7/16 x 3/16	3
8	629 008 DP	6 x 2-7/16 x 3/16	3
12	629 012 DP	9 x 2-7/16 x 3/16	6-1/2

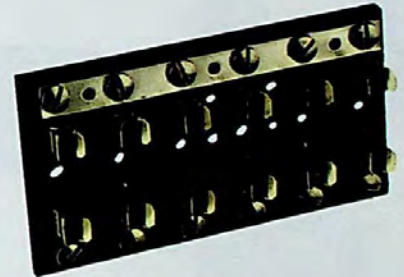

FIG. 629

FIG. 694 - FUSE PANELS

**RATED FOR 20 AMPS AT 12, 24 AND 32 VOLTS.
FOR 1/4" x 1-1/4" FUSES**

**INCLUDES CENTER CLIP FOR SPARE FUSE.
MOLDED PLASTIC BASE WITH BRASS HARDWARE**

ORDERING INFORMATION

Number of Gangs	Display Pkg. - 5 Bags 1 Pc. per Bag	Dimensions Inches	Weight Ounces
2	694 DP	2-7/16 x 1-1/2 x 3/16	1-1/2



FIG. 694

Important Note: All of the Above Items Conform to U.S.C.G. Electrical Standards. See Page 76.

TERMINAL BLOCKS & FUSEHOLDER

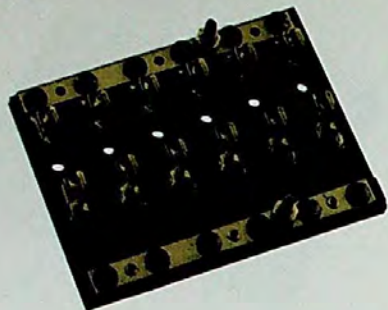

Fig. 647

FIG. 647 - COMBINATION FUSE & TERMINAL BLOCK

**RATED FOR 20 AMPS AT 12, 24 AND 32 VOLTS.
FOR 1/4" x 1-1/4" FUSES**

**WITH BINDING POSTS
MOLDED PLASTIC BASE WITH BRASS HARDWARE**

ORDERING INFORMATION

Number of Gangs	Display Pkg. - 5 Bags 1 Pc. per Bag	Dimensions Inches	Weight Ounces
4	647 004 DP	3 x 3-5/16 x 3/16	3-1/2
6	647 006 DP	4-1/2 x 3-5/16 x 3/16	5
8	647 008 DP	6 x 3-5/16 x 3/16	7
12	647 012 DP	9 x 3-5/16 x 3/16	11



Fig. 627

FIG. 627 - TERMINAL BLOCKS

RATED FOR 30 AMPS AT 12, 24 AND 32 VOLTS.

MOLDED PLASTIC BASE WITH BRASS HARDWARE

ORDERING INFORMATION

Number of Gangs	Display Pkg. - 5 Bags 1 Pc. per Bag	Dimensions Inches	Weight Ounces
2	627 002 DP	1-1/2 x 1-1/2 x 3/16	1
4	627 004 DP	3 x 1-1/2 x 3/16	2
6	627 006 DP	4-1/2 x 1-1/2 x 3/16	2-1/4



Fig. 786

FIG. 786 - IN-LINE FUSEHOLDER

**RATED FOR 20 AMPS AT 12, 24 AND 32 VOLTS.
FOR 1/4" x 1-1/4" FUSES**

**COMPLETE WITH 12 VOLT, 20 AMP FUSE
AND 7-1/2 INCH WIRE LEAD.**

MOLDED PLASTIC

ORDERING INFORMATION

Length Inches	Diameter Inches	Display Pkg. - 10 Cards 1 Pc. per Card	Weight Ounces
2-1/8	11/16	786 DP	3/4



Important Note: All of the Above Items Conform to A.B.Y.C. Electrical Standards. See Page 76.

CONNECTIONS & CABLE OUTLETS



FIG. 720 - FLAT LINE CONNECTORS

**RATED FOR 15 AMPS AT 12, 24 AND 32 VOLTS.
POLARIZED
BOTH SIDES HAVE 12 INCH, 18 GAUGE COLOR
CODED WIRE LEADS**

MOLDED PLASTIC BODIES WITH BRASS CONTACTS

ORDERING INFORMATION

Number of Poles	Display Pkg. - 5 Cards 1 Pc. per Card	Width Inches	Weight Ounces
2	720 DP2	5/8	1
3	720 DP3	7/8	1-1/2
4	*720 DP4	1-1/8	2

*All contacts are shrouded.



FIG. 720-2

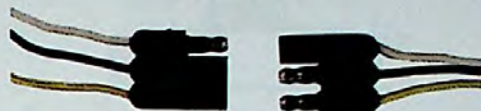

FIG. 720-3



FIG. 720-4 SHROUDED

FIGS. 1189 & 1190 - WATERTIGHT DECK CONNECTIONS



**RATED FOR 15 AMPS AT 12, 24 AND 32 VOLTS.
POLARIZED DOUBLE CONTACT CONNECTOR**

FIG. 1189, CHROME PLATED BRASS

FIG. 1190, CHROME PLATED ZINC

**FLANGE GASKET WITH INTEGRAL WATERPROOF CAP
FOR BASE WHEN PLUG IS REMOVED.**

ORDERING INFORMATION

Diameter Inches	Height Inches	Display Pkg. - 10 Cards 1 Pc. per Card	OEM Bulk Pkg. 50 Pcs.	Screw Size	Weight Ounces
1-5/8	1-3/16	1189 DP CHR	1189 000 CHR	6	2-1/2
1-5/8	1-3/16	1190 DP CHR	1190 000 CHR	6	2-1/2

Spare Connector with Cover, Cat. No. 1189 DP 99A.

Spare Connector Only, Cat. No. 42.

Note: These Items Are Not Ignition Protected.



FIG. 1189 -
CHROME PLATED BRASS

FIG. 1190 -
CHROME PLATED ZINC

Important Note: All of the Above Items Conform to U.S.C.G. Electrical Standards. See Page 76.

FIGS. 424 & 1191 - WATERTIGHT CABLE OUTLETS



FOR 5/16 INCH O.D. CABLE

FIG. 424, CHROME PLATED BRASS

FIG. 1191, CHROME PLATED ZINC

**EQUIPPED WITH RUBBER GROMMET
FOR WATERTIGHT PASSAGE OF CABLE.**

ORDERING INFORMATION

Diameter Base Inches	Display Pkg. - 10 Cards 1 Pc. per Card	Screw Size	Weight Ounces
1-1/4	424 DP CHR	6	1
1-1/4	1191 DP CHR	6	1



FIG. 424 - CHROME PLATED BRASS

FIG. 1191 - CHROME PLATED ZINC

CABLE STRAPS & LINE SUPPORT CLIPS



FIG. 121 - BRASS CABLE STRAP

FOR CABLE, TUBING, CONTROL WIRE, ETC.



Fig. 121

ORDERING INFORMATION

I.D. Inches	Length Inches	Display Pkg. - 10 Bags 10 Pcs. per Bag
1/8	1-7/16	121 DP1 PLB
3/16	1-3/8	121 DP2 PLB
1/4	1-5/16	121 DP3 PLB*
5/16	1-3/16	121 DP4 PLB
3/8	1-5/8	121 DP5 PLB
7/16	1-5/8	121 DP6 PLB
1/2	1-1/2	121 DP7 PLB
5/8	1-3/4	121 DP8 PLB
3/4	1-7/8	121 DP9 PLB

Width all sizes - 1/2 inch.

* Size No. 3 packaged in cards

Note: This Item Conforms to U.S.C.G. Fuel Standards



FIG. 196 - PLASTIC CABLE STRAP

BLACK PLASTIC, ULTRA-VIOLET STABILIZED FOR WEATHER RESISTANCE.
ELIMINATES THE NEED FOR INSULATING CUSHION.



Fig. 196

ORDERING INFORMATION

I.D. Inches	Display Pkg. - 10 Cards 10 Pcs. per Card	OEM Pkg. 500 Pcs.
3/16	196 DP1	196 001
1/4	196 DP2	196 002
5/16	196 DP3	196 003
3/8	196 DP4	196 004
1/2	196 DP5	196 005
5/8	196 DP6	196 006
3/4	196 DP7	196 007

Width all sizes - 1/2 inch.

Note: This Item Conforms to U.S.C.G. Electric Standards



FIGS. 163, 164, 165 - LINE SUPPORT CLIPS

ALUMINUM WITH SYNTHETIC RUBBER CUSHION



Fig. 163
SINGLE



Fig. 164
DOUBLE



Fig. 165
TRIPLE

ORDERING INFORMATION

For O.D. Line Inches	Width Inches	Single	Double	Triple
		Display Pkg. - 10 Cards 10 Pcs. per Card	Display Pkg. - 10 Cards 10 Pcs. per Card	Display Pkg. - 10 Cards 10 Pcs. per Card
3/16	3/8	163 DP1 ALU	164 DP1 ALU	-----
1/4	3/8	163 DP2 ALU	164 DP2 ALU	-----
5/16	1/2	163 DP3 ALU*	164 DP3 ALU	165 DP3 ALU
3/8	1/2	163 DP4 ALU*	164 DP4 ALU	165 DP4 ALU
1/2	1/2	163 DP5 ALU	164 DP5 ALU*	165 DP5 ALU*
5/8	1/2	163 DP6 ALU*	-----	-----

*OEM Package - 500 Pcs. Replace "DP" with "00" When Ordering.

Note: This Item Conforms to U.S.C.G. Electric & Fuel Standards



SPARE BULBS FOR UTILITY LIGHTS

FIG. 432 - SEALED BEAM UNITS ORDERING INFORMATION

Nominal Voltage	Wattage	Amps	Display Pkg. 5 Cards	Bulbs per Pkg.	Bulb Length Inches	Mfg. Lamp No.
12	35	3	432 001 12V	1	2-3/4	4406
24	50	2	432 002 24V	1	2-3/4	4593
32	60	2	432 003 32V	1	2-3/4	4350



FIG. 432

FIG. 337 - DOUBLE CONTACT BAYONET BASE BULB

CLEAR

ORDERING INFORMATION

Nominal Voltage	Wattage	Amps	Display Pkg. 5 Cards	Bulbs per Card	Bulb Diameter Inches	Mfg. Lamp No.
12	7	.58	337 011 DP	2	3/4	90
12	11	.94	337 012 DP	2	3/4	1004
12	17	1.44	337 013 DP	2	1	1142
24	15	.63	337 014 DP	1	1	306
32	13	.40	337 018 DP	1	3/4	624
32	14	.43	337 019 DP	1	1	1228
32	21	.66	337 020 DP	1	1	1692
32	24	.74	337 021 DP	1	1-3/8	1054
120	15	---	337 023 DP	2	7/8	15T7



FIG. 337



FIG. 67 & 70 - DOUBLE ENDED FESTOON BULBS

CLEAR

NICKEL PLATED BRASS CAPS

ORDERING INFORMATION

Nominal Voltage	Wattage	Amps	Display Pkg. - 5 Cards 2 Bulbs per Card	Bulb Diameter Inches	Bulb Length Inches
12	10	.74	70 DP0 CLR	3/8	1-11/16
12	15	.97	70 DP1 CLR	9/16	1-11/16
24	10	.42	67 DP1 CLR	3/8	1-11/16

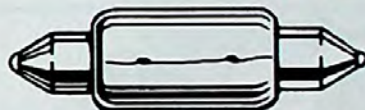

FIG. 70



FIG. 340 - MEDIUM SCREW BASE BULB

ORDERING INFORMATION

Nominal Voltage	Wattage	Amps	Standard Pkg. 6 Bulbs	Type	L.C.L. Inches	Mfg. Lamp No.
12	15	1.25	340 005 FRD	A-17	2-3/8	15-A
12	25	2.08	340 006 FRD	A-19	2-9/16	25-A
12	50	4.16	340 007 FRD	A-21	3-7/16	50-A21
32	15	.47	340 011 FRD	A-17	2-3/8	15-A
32	25	.78	*340 012 FRD	A-19	2-9/16	25-A
32	50	1.56	*340 013 FRD	A-21	3-7/16	50-A21



FIG. 340



*Standard Pkg. - 2 Bulbs

Note: High Power Bulbs and Sealed Beam Units for Searchlights, See Searchlight Section.
ELECTRIC BULBS ARE NOT RETURNABLE. ORDER CAREFULLY

Note: Figs. 162 & 349 Conform to A.B.Y.C. Standard A-23 in Accordance with the '72 COLREGS and U.S. Inland Rules for Use on Vessels Under 5 Meters (16.4 ft.) in Length.



FIG. 162

FIG. 162 - FOG HORN

**ALUMINUM WITH WHITE BAKED ENAMEL FINISH
NYLON MOUTHPIECE**

ORDERING INFORMATION

Length Inches	Display Pkg. - 10 Bags 1 Pc. per Bag	Weight Ounces
12-1/2	162 DP WHT	6



FIG. 349

FIG. 349 - "BALL TYPE" WHISTLE

ORANGE PLASTIC

ORDERING INFORMATION

Length Inches	Width Inches	Display Pkg. - 10 Cards 1 Pc. per Card	OEM Bulk Pkg. 100 Pcs.	Weight Ounces
2-1/4	3/4	349 DP	349	1-1/2



FIG. 441

FIG. 441 - PORTLIGHT CHAIN

STAINLESS STEEL CHAIN WITH CHROME PLATED FITTINGS

ORDERING INFORMATION

Length Inches	Length Strap Inches	Display Pkg. - 5 Cards 1 Pc. per Card	OEM Bulk Pkg. 50 Pcs.	Screw Size	Weight Ounces
7	1-7/8	441 DP CHR	441 000 CHR	8	2

FIG. 461 - PORTLIGHT WEATHERSTRIPPING

**OPEN CELL FOAM RUBBER
SUPPLIED IN TEN FOOT LENGTHS**

ORDERING INFORMATION



FIG. 461

Height Inches	Min. Width Inches	Max. Width Inches	Standard Pkg. - 1 Length
3/8	1/4	7/16	461



FIG. 708

FIG. 708 - YACHT LOG BOOK

**ALL NEW DESIGN
120 PAGES 8-1/4" X 11"**

All New Design includes expanded Vessel and Equipment Information listings, weather symbols and a modified Beaufort wind scale, VHF radio channel assignments & marine radio procedures, marine radio log, Most frequently used courses, repair & maintenance logs, and expense journal, GPS/Loran waypoint log, expanded cruising log, a diary & notes section and a friends & guest log and Cover is hard bound with a water resistant washable finish. Navy blue with gold lettering.

ORDERING INFORMATION

Display Pkg. - 5 Bags 1 Pc. per Bag	Weight Ounces
708 DP	18

COWL & CLAM SHELL VENTILATORS

FIG. 1312 - COWL VENTILATOR

CHROME PLATED ZINC COWL WITH BLACK PLASTIC BASE
3 Inch Duct Threads into Neck, Hose Clamps Not Required

chromalex®

ORDERING INFORMATION

Mouth Opening Square Inches	Length Overall Inches	Width Overall Inches	Height Overall Inches	Display Pkg. - 5 Cards 1 Pc. per Card	OEM Bulk Pkg. 50 Pcs.	Screw Size	Weight Ounces
8	5-3/4	4-3/8	2-5/8	1312 DP CHR	1312 000 CHR	8	12



FIG. 1312

FIG. 870 - COWL VENTILATOR

CHROME PLATED ZINC
3 Inch Duct Threads into Neck, Hose Clamps Not Required

ORDERING INFORMATION

Mouth Opening Square Inches	Length Overall Inches	Width Overall Inches	Height Overall Inches	Standard Pkg. 5 Pcs.	Screw Size	Weight Ounces
7-1/3	5-1/8	4	3-7/8	870 000 CHR	10	21



FIG. 870

FIG. 510 - COWL VENTILATOR

POLISHED OR CHROME PLATED BRASS. CAST BRONZE DECK PLATE
Internal Thumb Screw Allows Cowl to be Locked in any Position.
Ventilators are Painted White Inside Only.

ORDERING INFORMATION

I.D. Deck Plate Inches	O.D. Deck Plate Inches	Diameter Mouth Inches	Height Overall Inches	Polished Brass Standard Pkg. - 1 Pc.	Chrome Plated Brass Standard Pkg. - 1 Pc.	Screw Size	Weight Pounds
4	7-1/16	8	11	510 004 POL	510 004 CHR	10	6-3/8

For Spare Deck Plates, Covers and Keys; Refer to Fig. No. 526, Page 105.



FIG. 510

FIG. 315 - CLAM SHELL VENTILATOR

CHROME PLATED BRASS

ORDERING INFORMATION

Dimensions Base Inches	Height Opening Inches	Width Opening Inches	Display Pkg. - 10 Cards 1 Pc. per Card	OEM Bulk Pkg. 100 Pcs.	Screw Size	Weight Ounces
1-5/8 x 1-1/2	7/16	7/8	315 DP1 CHR	315 001 CHR	4	1/2
2 x 2	9/16	1-7/8	315 DP2 CHR	315 002 CHR	6	1-1/4



FIG. 315

FIG. 339 - CLAM SHELL VENTILATOR

CHROME PLATED BRASS

ORDERING INFORMATION

Dimensions Base Inches	Height Opening Inches	Width Opening Inches	Display Pkg. - 5 Cards 1 Pc. per Card	OEM Bulk Pkg. 25 Pcs.	Screw Size	Weight Ounces
4 x 3-3/4	1-5/8	2-1/2	339 DP CHR	339 000 CHR	6	5-1/2



FIG. 339

GAS TANK VENTS

FIG. 570 - GAS TANK VENT

CHROME PLATED ZINC COWL WITH BLACK OR WHITE PLASTIC CAP AND REMOVABLE 30 MESH, STAINLESS STEEL WIRE SCREEN FLAME ARRESTER



FIG. 570

chromalex®

ORDERING INFORMATION

	Hose Size Inches	Max. Hull Thickness Inches	Display Pkg. - 10 Cards 1 Pc. per Card	OEM Bulk Pkg. 50 Pcs.	Weight Ounces
Color					
Black	5/8	3/4	570 DP4 BLK	570 004 BLK	3
White	5/8	3/4	570 DP4 WHT	570 004 WHT	3



FIG. 571 - GAS TANK VENT WITH SWIVEL ELBOW

BLACK OR WHITE PLASTIC CAP WITH ZINC ELBOW AND REMOVABLE 30 MESH, STAINLESS STEEL SCREEN FLAME ARRESTER
Design Allows Elbow to be Rotated to any Position



FIG. 571

ORDERING INFORMATION

	Hose Size Inches	Max. Hull Thickness Inches	Display Pkg. - 10 Cards 1 Pc. per Card	OEM Bulk Pkg. 50 Pcs.	Weight Ounces
Color					
Black	5/8	3/4	571 DP4 BLK	571 004 BLK	3
White	5/8	3/4	571 DP4 WHT	571 004 WHT	3



FIG. 561 - GAS TANK VENT WITH SWIVEL ELBOW

CHROME PLATED ZINC CAP WITH ZINC ELBOW, BLACK PLASTIC SPLASH GUARD AND REMOVABLE 30 MESH, STAINLESS STEEL WIRE SCREEN FLAME ARRESTER
Design Allows Elbow to be Rotated to any Position



FIG. 561

chromalex®

ORDERING INFORMATION

	Hose Size Inches	Max. Hull Thickness Inches	Display Pkg. - 10 Cards 1 Pc. per Card	OEM Bulk Pkg. 50 Pcs.	Weight Ounces
	5/8	1	561 DP4 CHR	561 004 CHR	3-1/4

Spare Splash Guard Cat. No. 518 000 BLK



FIG. 506 - GAS TANK VENT

CHROME PLATED ZINC WITH BLACK PLASTIC SPLASH GUARD AND REMOVABLE 30 MESH, STAINLESS STEEL WIRE SCREEN FLAME ARRESTER



FIG. 506

chromalex®

ORDERING INFORMATION

	Hose Size Inches	Max. Hull Thickness Inches	Display Pkg. - 10 Cards 1 Pc. per Card	OEM Bulk Pkg. 100 Pcs.	Weight Ounces
	5/8	3/4	506 DP4 CHR	506 004 CHR	3

Spare Splash Guard Cat. No. 518 000 BLK

Note: All of the Above Vents are Designed to Meet the Requirements of U.S.C.G. Safety Standards January 31, 1977, for Gasoline Fuel Systems 33CFR183.

GAS TANK VENTS

FIG. 509 - GAS TANK VENT

**CHROME PLATED BRONZE WITH REMOVABLE 30 MESH,
STAINLESS STEEL WIRE SCREEN FLAME ARRESTER**



FIG. 509

ORDERING INFORMATION

Hose Size Inches	Max. Hull Thickness Inches	Display Pkg. - 5 Cards 1 Pc. per Card	OEM Bulk Pkg. 50 Pcs.	Weight Ounces
5/8	3/4	509 DP4 CHR	509 004 CHR	4
3/4	5/8	509 DP5 CHR	509 005 CHR	6

FIG. 503 - GAS TANK VENT

**CHROME PLATED BRONZE WITH REMOVABLE 30 MESH,
STAINLESS STEEL WIRE SCREEN FLAME ARRESTER**



FIG. 503

ORDERING INFORMATION

Thread Size Inches	Max. Hull Thickness Inches	Display Pkg. - 5 Cards 1 Pc. per Card	OEM Bulk Pkg. 50 Pcs.	Weight Ounces
3/8	7/8	503 DP3 CHR	503 003 CHR	5-1/2
1/2	7/8	503 DP4 CHR	503 004 CHR	6

FIG. 515 - GAS TANK VENT

**CHROME PLATED BRONZE WITH REMOVABLE 30 MESH,
STAINLESS STEEL WIRE SCREEN FLAME ARRESTER**



FIG. 515

ORDERING INFORMATION

Thread Size Inches	Max. Hull Thickness Inches	Display Pkg. - 5 Cards 1 Pc. per Card	OEM Bulk Pkg. 50 Pcs.	Weight Ounces
3/8	5/8	515 DP3 CHR	515 003 CHR	3
1/2	5/8	515 DP4 CHR	515 004 CHR	4

FIG. 505 - GAS TANK VENT

**CHROME PLATED CAST BRONZE WITH REMOVABLE 30 MESH,
STAINLESS STEEL WIRE SCREEN FLAME ARRESTER**



Designed to meet the requirements of the National Fire Protection Association Booklet No. 302, Section No. 323 on vent pipe outlets. The 1/2 inch N.P.T. is off center to create a water baffle.



FIG. 505

ORDERING INFORMATION

O.D. Flange Inches	O.D. Neck Inches	Length Neck Inches	Display Pkg. - 5 Cards 1 Pc. per Card	OEM Bulk Pkg. 25 Pcs.	Screw Size	Weight Ounces
2-1/2	1-3/16	1-1/2	505 DP CHR	505 000 CHR	8	6-1/2

Note: All of the Above Vents are Designed to Meet the Requirements of U.S.C.G. Safety Standards January 31, 1977, for Gasoline Fuel Systems 33CFR183.

VENTILATORS



FIG. 707 - VENTILATOR

**CHROME PLATED BRASS FRAME
PERFORATED STAINLESS STEEL SCREEN**



Fig. 707

ORDERING INFORMATION

Dimensions Inches	Display Pkg. - 10 Cards 1 Pc. per Card	OEM Bulk Pkg. 25 Pcs.	Screw Size	Weight Ounces
7-1/4 x 1-1/2	707 DP CHR	707 000 CHR	8	2



FIG. 330 - LOCKER VENTILATOR

CHROME PLATED BRASS



Fig. 330

ORDERING INFORMATION

O.D. Inches	Display Pkg. - 10 Cards 1 Pc. per Card	OEM Bulk Pkg. 100 Pcs.	Screw Size	Weight Ounces
2-1/2	330 DP1 CHR	330 001 CHR	6 R.H.	3/4
3-1/4	330 DP2 CHR	330 002 CHR	6 R.H.	1



FIG. 550 - TRANSOM OR LOCKER VENTILATOR

CHROME PLATED BRASS



Fig. 550

ORDERING INFORMATION

Dimensions Inches	Display Pkg. - 10 Cards 1 Pc. per Card	OEM Bulk Pkg. 25 Pcs.	Screw Size	Weight Ounces
7 x 2-1/2	550 DP CHR	550 000 CHR	8	3



FIG. 1271 - TRANSOM OR LOCKER VENTILATOR

CHROME PLATED ZINC

WITH ANODIZED ALUMINUM EXPANDED MESH SCREEN



Fig. 1271

ORDERING INFORMATION

Dimensions Inches	Display Pkg. - 10 Cards 1 Pc. per Card	OEM Bulk Pkg. 25 Pcs.	Screw Size	Weight Ounces
6 x 2	1271 DP CHR	1271 000 CHR	8	3



FIG. 1238 - TRANSOM OR LOCKER VENTILATOR

CHROME PLATED ZINC

WITH ANODIZED ALUMINUM GRILL-TYPE SCREEN



Fig. 1238

ORDERING INFORMATION

Dimensions Inches	Display Pkg. - 10 Cards 1 Pc. per Card	OEM Bulk Pkg. 50 Pcs.	Screw Size	Weight Ounces
8-3/8 x 2-1/4	1238 DP CHR	1238 000 CHR	8	4

VENTILATORS

FIG. 334 - LOUVER VENTILATOR



CHROME PLATED BRASS

ORDERING INFORMATION

Dimensions Inches	Length Louvers Inches	Display Pkg. - 5 Cards 1 Pc. per Card	OEM Bulk Pkg. 10 Pcs.	Weight Ounces
3 x 2-1/2	2	334 002 DP	334 002 CHR	1-1/5
4 x 2-1/2	3	334 02A DP	334 02A CHR	1-4/5
5-1/2 x 2-1/2	2	334 004 DP	334 004 CHR	2-1/2
7-1/2 x 2-1/2	3	334 04A DP	334 04A CHR	3-1/5
8 x 2-1/2	2	334 006 DP	334 006 CHR	3-1/2
11 x 2-1/2	3	334 06A DP	334 06A CHR	4-1/2

Screw Size #4 R.H.

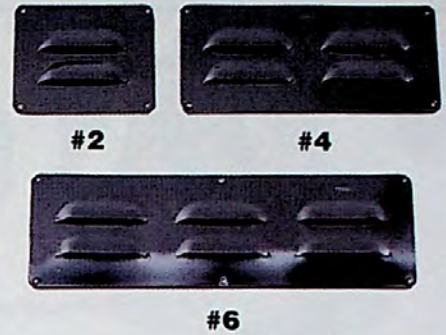

FIG. 334

FIG. 335 - LOUVER VENTILATOR



CHROME PLATED BRASS

ORDERING INFORMATION

Dimensions Inches	Length Louvers Inches	Display Pkg. - 5 Cards 1 Pc. per Card	OEM Bulk Pkg. 10 Pcs.	Weight Ounces
3 x 3	2	335 003 DP	335 003 CHR	1-1/2
4 x 3-1/2	3	335 03A DP	335 03A CHR	2
5-1/2 x 3	2	335 006 DP	335 006 CHR	3
7-1/2 x 3-1/2	3	335 06A DP	335 06A CHR	4-1/2
8 x 3	2	335 009 DP	335 009 CHR	4
11 x 3-1/2	3	335 09A DP	335 09A CHR	6-1/2

Screw Size #4 R.H.

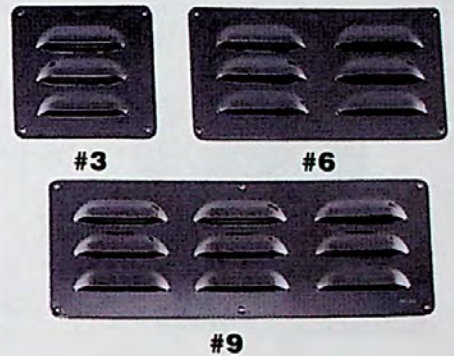

FIG. 335

FIG. 336 - LOUVER VENTILATOR



CHROME PLATED BRASS

ORDERING INFORMATION

Dimensions Inches	Length Louvers Inches	Display Pkg. - 5 Cards 1 Pc. per Card	OEM Bulk Pkg. 10 Pcs.	Weight Ounces
3-3/4 x 3	2	336 004 DP	336 004 CHR	2
4-3/8 x 4	3	336 04A DP	336 04A CHR	3
4-1/2 x 3	2	336 005 DP	336 005 CHR	2-1/2
5-3/8 x 4	3	336 05A DP	336 05A CHR	3-4/5
5-1/4 x 3	2	336 006 DP	336 006 CHR	2-4/5
6-3/8 x 4	3	336 06A DP	336 06A CHR	4-1/3

Screw Size #4 R.H.

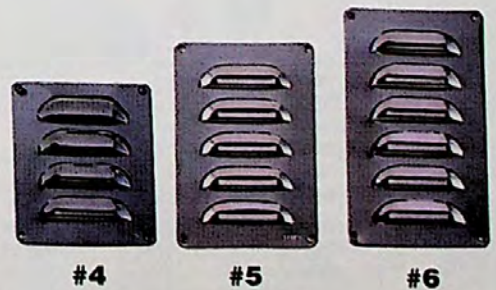

FIG. 336

FOG BELLS

THE 8 AND 12 INCH BELLS LISTED ON THIS PAGE HAVE BEEN REVIEWED BY THE U.S. COAST GUARD AND COMPLY WITH C.G. 169 REGULATIONS FOR SOUND SIGNAL APPLIANCES AS REQUIRED BY ANNEX III PARAGRAPH 2 OF THE '72 COLREGS. THE 8 INCH SIZES ARE FOR USE ON VESSELS UNDER 20 METERS (65.6 FT.) IN LENGTH. THE 12 INCH SIZE IS FOR USE ON VESSELS OF ANY LENGTH.



FIG. 420 POLISHED

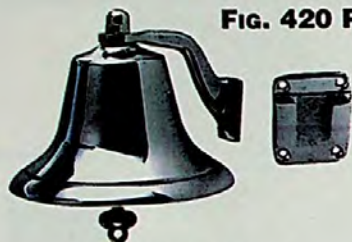

FIG. 420 CHROME

FIG. 420 - FOG BELL

CAST BRONZE

Polished or Chrome Plated Bronze
Medium Weight, Removable

ORDERING INFORMATION

Bottom Diameter Inches	Height Overall Inches	Polished Bronze Std. Pkg. - 1 Pc.	Chrome Plated Bronze Std. Pkg. - 1 Pc.	Weight Pounds
6	5	420 006 POL	420 006 CHR	4-1/4
8	6-1/8	420 008 POL	420 008 CHR	7-1/8

Screw Size #8 F.H.

FIG. 150 - FOG BELL

CAST BRONZE

Plain, Polished or Chrome Plated Bronze
Heavy Weight, Removable

ORDERING INFORMATION

Bottom Diameter Inches	Height Overall Inches	Plain Bronze Std. Pkg. - 1 Pc.	Polished Bronze Std. Pkg. - 1 Pc.	Chrome Plated Bronze Std. Pkg. - 1 Pc.	Weight Pounds
8	8	150 008 PLB	150 008 POL	150 008 CHR	11
12	12	150 012 PLB	150 012 POL	150 012 CHR	28-1/4

Screw Size 1/4" F.H.

SPARE PARTS ORDERING INFORMATION FOR PAGES 86 AND 87.

For complete Spare Part No. Insert Finish Code: P or PLB, for Plain Bronze or Brass Finish (i.e. 420 P06 99A or 127 000 PLB)
B or POL, for Polished Bronze or Brass Finish (i.e. 420 B06 99A or 127 000 POL)
C or CHR, for Chrome Plated Finish (i.e. 420 C06 99A or 127 000 CHR)

ARMS		WALL PLATES		CLAPPERS		EYE BOLTS		ACORN NUTS	
Figure No.	Spare Part No.	Figure No.	Spare Part No.	Figure No.	Spare Part No.	Figure No.	Spare Part No.	Figure No.	Spare Part No.
420-6"	420-99A-6"	420-6"	127	420-6"	153	420-6"	113	420-6"	465 004
420-8"	171	420-8"	127	420-8"	144	420-8"	123	420-8"	465 008
150-8"	171	150-8"	127	150-8"	144	150-8"	123	150-8"	465 008
150-12"	150-99A-12"	150-12"	150-99B-12"	150-12"	172	150-12"	172	150-12"	465 009
*158-12"	158-99A-12"	*158-12"	158-99A-12"	*158-12"	172	*158-12"	172	158-12"	465 009
*159-8-14"	158-99A-14"	*159-8-14"	158-99A-14"	*159-8-14"	172	*159-8-14"	172	159-8-14"	465 009
179	179-000-99A	179	179-000-99A	179	144	179	179-99B	179	465 008
159-6"	159-99A	159-6"	166	159-6"	159-99B	159-6"	113	159-6"	465 004
159-8"	159-99A	159-8"	166	159-8"	153	159-8"	113	159-8"	465 004

*Includes Wall Bracket

*Includes Arm

*Includes Eye Bolt

*Includes Clapper

FOG BELLS

THE 8 AND 12 INCH BELLS LISTED ON THIS PAGE HAVE BEEN REVIEWED BY THE U.S. COAST GUARD AND COMPLY WITH C.G. 169 REGULATIONS FOR SOUND SIGNAL APPLIANCES AS REQUIRED BY ANNEX III PARAGRAPH 2 OF THE '72 COLREGS. THE 8 INCH SIZE IS FOR USE ON VESSELS UNDER 20 METERS (65.6 FT.) IN LENGTH. THE 12 INCH SIZE IS FOR USE ON VESSELS OF ANY LENGTH.

FIG. 158 - FOG BELL

CAST BRONZE

Plain, Polished or Chrome Plated Bronze
Heavy Weight, Fixed Mounting

ORDERING INFORMATION

Bottom Diameter Inches	Height Overall Inches	Plain Bronze Std. - 1 pc.	Polished Bronze Std. Pkg. - 1 Pc.	Chrome Plated Bronze Std. Pkg. - 1 Pc.	Weight Pounds
12	12	158 012 PLB	158 012 POL	158 012 CHR	29-2/3

Screw Size 1/4" R.H.



FIG. 158 POLISHED

FIG. 179 - FOG BELL

WROUGHT BRASS

Plain Brass
Light Weight, Fixed Mounting

ORDERING INFORMATION

Bottom Diameter Inches	Height Overall Inches	Standard Pkg. - 1 Pc.	Weight Pounds
12	8	179 012 PLB	7-3/4

Screw Size #12 R.H.



FIG. 179

FIG. 159 - FOG BELL

STAMPED BRASS

Plain or Chrome Plated Brass
Light Weight, Removable

ORDERING INFORMATION

Bottom Diameter Inches	Height Overall Inches	Chrome Plated Display Pkg. - 2 Pcs. 1 Pc. per Pkg.	Plain Brass Display Pkg. - 2 Pcs. 1 Pc. per Pkg.	Weight Pounds
6	4	159 DP6 CHR	159 DP6 PLB	1-1/2
8	5	159 DP8 CHR	159 DP8 PLB	2-3/4

Screw Size #4 F.H.



FIG. 159 CHROME



FIG. 159 PLAIN

INTAKE WATER STRAINERS

FIGS. 493 & 500 - INTAKE WATER STRAINERS CAST BRONZE

PERKO WATER STRAINERS ARE DESIGNED FOR EASY INSTALLATION AND CLEANING. FEATURES INCLUDE MOUNTING LUGS CAST INTO BOTH SIDES TO ASSURE UNIVERSAL MOUNTING, FOUR OUTSIDE TIE RODS AND A 304 STAINLESS STEEL STRAINER BASKET TO MINIMIZE ELECTROLYSIS. SCREEN HOLE SIZE DIAMETER .077 INCHES, 46% OPEN AREA. HINGED LUGS FOR THE CAST BRONZE COVER PERMIT EASY REMOVAL AND CLEANING OF THE STRAINER BASKET. A DRAIN PLUG IN THE BOTTOM CASTING IS PROVIDED FOR EASILY REMOVING SEDIMENT AND DRAINING FOR WINTERIZING.

FOR APPLICATIONS REQUIRING HIGHER CAPACITY SEE FIG. 500 BELOW



FIG. 493

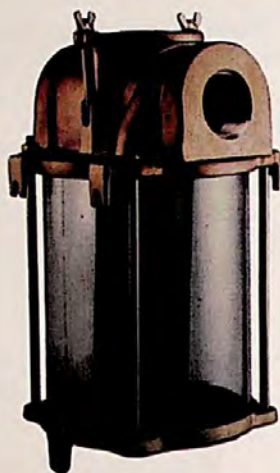

FIG. 500

ORDERING INFORMATION FOR FIG. 493

Pipe Size Inches	Height Overall Inches	Width Overall Inches	Standard Pkg. - 1 Pc.	Dimensions Cylinder Inches	Dimensions Basket Inches	Open Area To Pipe Size Ratio	Weight Pounds	Spare Gasket Kit* Display Pkg. - 5 kts 1 Kit. per Bag
1/2	5-3/4	4-1/2	493 004 PLB	3-1/2 x 4	1-13/16 x 4-3/8	30:1	5	493 DP4 99M
3/4	8-3/8	4-1/2	493 005 PLB	3-1/2 x 6	1-13/16 x 6-1/4	25:1	5	493 DP5 99M
1	9-1/2	5-1/2	493 006 PLB	4-1/2 x 5-1/2	2-5/8 x 5-7/8	20:1	8	493 DP6 99M
1-1/4	10	5-1/2	493 007 PLB	4-1/2 x 6	2-5/8 x 6-1/4	13:1	8	493 DP7 99M
1-1/2	11-1/2	7-1/4	493 008 PLB	6 x 8	3-5/16 x 8-7/16	17:1	14	493 DP8 99M
2	16	7-1/2	493 009 PLB	6 x 12	3-5/16 x 12-1/4	13:1	18	493 DP9 99M
2-1/2	16	7-1/2	493 010 PLB	6 x 12	3-5/16 x 12-1/2	10:1	18	493 DPX 99M

ORDERING INFORMATION FOR FIG. 500

Pipe Size Inches	Height Overall Inches	Width Overall Inches	Standard Pkg. - 1 Pc.	Dimensions Cylinder Inches	Dimensions Basket Inches	Open Area To Pipe Size Ratio	Weight Pounds	Spare Gasket Kit* Standard Pkg. - 1 kit
2	14-1/2	9	500 009 PLB	8 x 10	3-7/8 x 10-1/4	20:1	34	500 009 99M
2-1/2	16-1/2	9	500 010 PLB	8 x 12	3-7/8 x 12-1/4	18:1	34	500 010 99M
3	18-1/2	9	500 011 PLB	8 x 14	3-7/8 x 14-1/4	14:1	34	500 011 99M

*Spare Gasket Kit Consists of: 1 - Cover Gasket and 2 - Cylinder Gaskets.

SPARE PARTS ORDERING INFORMATION

For Spare Part No. Insert a Spare Part Code Listed Below in Place of the "PLB" in the Strainer's Catalog Number (i.e., 493 006 99A, Top Casting for 1" Strainer).

Top Casting	99A	Cover with Gasket	99E	Cover Gaskets (2 Per Bag)	99N
Bottom Casting	99B	Hinged Bolt for Cover		Tie Rods, Nuts and Washers	99P
Transparent Cylinder	99C	With Pin, Nut and Washer	99L	Consists of:	
Basket Strainer	99D			(4 Each for 493 Series)	
				(1 Each for 500 Series)	

INTAKE WATER STRAINERS

**FIG. 493 & 500 - INTAKE WATER STRAINERS
DIFFERENTIAL PRESSURE GRAPHS**

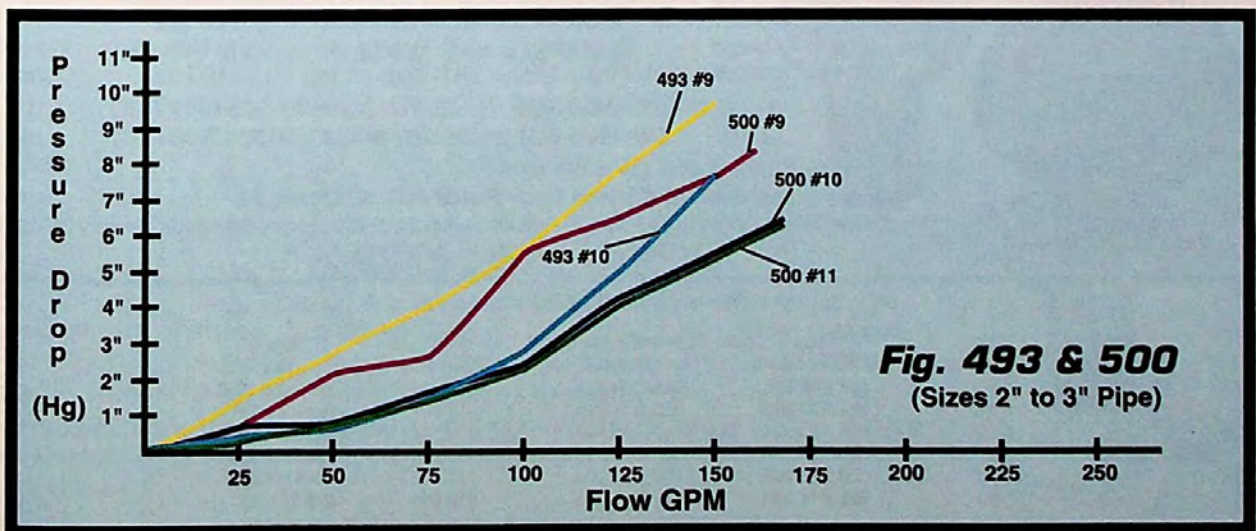
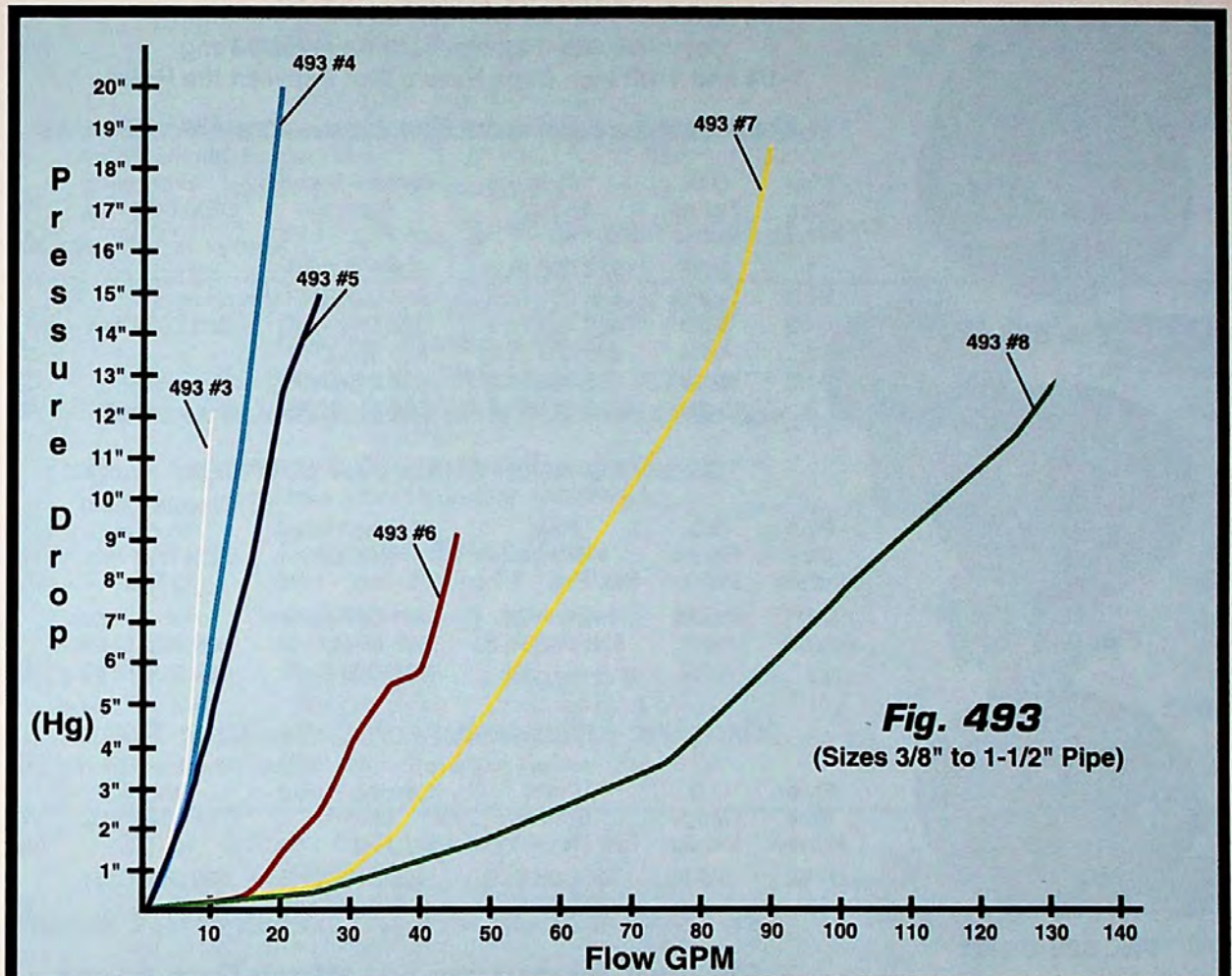

DECK PLATES



FIG. 528 - DECK PLATES FOR PIPE

CAST BRONZE PLAIN OR CHROME PLATED

Complete with Fig. No. 1248 Key and O-Ring.
1-1/4 and 1-1/2 Inch Caps Have a Slot Between the Holes.

ORDERING INFORMATION FOR UNMARKED DECK PLATES

Pipe Size Inches	O.D. Flange Inches	Plain Bronze Std. Pkg. - 1 Pc.	Chrome Plated Bronze Std. Pkg. - 1 Pc.	Chrome Plated Bronze	Weight Ounces
				OEM Bulk Pkg. 10 Pcs.	
1	2-7/8	528 006 PLB	528 006 CHR	-----	12
1-1/4	3-5/16	528 007 PLB	528 007 CHR	-----	12
1-1/2	3-5/8	528 008 PLB	*528 DP8 CHR	528 008 CHR	16
2	4-1/4	528 009 PLB	528 009 CHR	-----	33-1/2
2-1/2	4-5/8	528 010 PLB	528 010 CHR	-----	33-1/2
3	5-3/8	528 011 PLB	528 011 CHR	-----	43-1/2



FIG. 528



FIG. 528 GAS

** ORDERING INFORMATION FOR GAS DECK PLATES

Pipe Size Inches	O.D. Flange Inches	Plain Bronze Std. Pkg. - 1 Pc.	Chrome Plated Bronze Std. Pkg. - 1 Pc.	Chrome Plated Bronze	Weight Ounces
				OEM Bulk Pkg. 10 Pcs.	
1-1/4	3-5/16	-----	528 G07 CHR	-----	12
1-1/2	3-5/8	528 G08 PLB	*528 DPG CHR	528 G08 CHR	16
2	4-1/4	-----	528 G09 CHR	528 G09 CHR	33-1/2

ORDERING INFORMATION FOR DIESEL DECK PLATES

Pipe Size Inches	O.D. Flange Inches	Plain Bronze Std. Pkg. - 1 Pc.	Chrome Plated Bronze Std. Pkg. - 1 Pc.	Chrome Plated Bronze	Weight Ounces
				OEM Bulk Pkg. 10 Pcs.	
1-1/2	3-5/8	528 D08 PLB	*528 DPD CHR	528 D08 CHR	16
2	4-1/4	528 D09 PLB	528 D09 CHR	-----	33-1/2



FIG. 528 DIESEL

ORDERING INFORMATION FOR WATER DECK PLATES

Pipe Size Inches	O.D. Flange Inches	Plain Bronze Std. Pkg. - 1 Pc.	Chrome Plated Bronze Std. Pkg. - 1 Pc.	Chrome Plated Bronze	Weight Ounces
				OEM Bulk Pkg. 10 Pcs.	
1-1/4	3-5/16	528 W07 PLB	528 W07 CHR	528 W07 CHR	12
1-1/2	3-5/8	528 W08 PLB	*528 DPW CHR	528 W08 CHR	16



FIG. 528 WATER

*Display Pack - 5 pcs. (1Pc. per card)

Screw Sizes: 2-1/2 and 3 Inch Deck Plates #10, All Others #8.

**Note: These Deck Plates Meet the Requirements of U.S.C.G. Safety Standards, January 31, 1977, for Gasoline Fuel Systems, 33CFR183.

Spare Parts Ordering Information

Pipe Size Inches	Plain Bronze Cap*	Chrome Plated Bronze Cap*	O-Rings Only (2 per bag)	Spare Key
1	528 P06 99A	528 C06 99A	513 006	1248 006 ZNC
1-1/4	528 P07 99A	528 C07 99A	513 007	1248 7-8 DP***
1-1/2	528 P08 99A	528 DP8 99A**	513 008	1248 7-8 DP***
2	528 P09 99A	528 C09 99A	513 009	1248 009 ZNC
2-1/2	528 P10 99A	528 C10 99A	513 010	1248 010ZNC
3	528 P11 99A	528 C11 99A	513 011	528 011 99C

* Complete With O-Ring.

** Display Pkg. - 5 pcs. (1 pc. per card).

*** Display Pkg. - 10 pcs. (1 pc. per card).

DECK PLATES

FIG. 524 - WASTE DECK PLATE FOR PIPE

CHROME PLATED BRONZE

Complete with Fig. No. 1248 Key and O-Ring
Cap Has a Slot Between the Holes.



Fig. 524

ORDERING INFORMATION

Pipe Size Inches	O.D. Flange Inches	Display Pkg. - 5 Cards 1 Pc. per Card	OEM Bulk Pkg. 10 Pcs.	Screw Size	Weight Ounces
1-1/2	3-5/8	524 DP CHR	524 000 CHR	8	16

Spare Cap with O-Ring, Cat. No. 524 DP 99A.
Spare Key, Cat. No. 1248 7-8 DP.

Spare O-Rings Only (2 per bag), Cat. No. 513 008.

FIG. 507 - WASTE DECK PLATE FOR HOSE

CHROME PLATED BRONZE

FIG. 508 - WASTE DECK PLATE FOR HOSE

CHROME PLATED BRONZE WITH BLACK PLASTIC CAP

Complete with Fig. No. 1248 Key and O-Ring
Cap Has a Slot Between the Holes.



Fig. 507

ORDERING INFORMATION

Hose Size Inches	O.D. Flange Inches	Length Neck Inches	Display Pkg. - 5 Cards 1 Pc. per Card	OEM Bulk Pkg. 25 Pcs.	Screw Size	Weight Ounces
1-1/2	3-1/8	3-1/2	507 DP CHR	507 000 CHR	8	14
1-1/2	3-1/8	3-1/2	508 DP CHR	508 000 CHR	8	11

Spare Cap with O-Ring, Cat. No. 507 DP 99A.
Spare Cap with O-Ring, Cat. No. 508 DP 99A.

Spare O-Rings Only (2 per bag), Cat. No. 513 008.
Spare Key, Cat. No. 1248 7-8 DP.



Fig. 508

FIG. 547 - WASTE DECK PLATE FOR HOSE

CHROME PLATED BRONZE CAP WITH BLACK PLASTIC NECK



FIG. 548 - WASTE DECK PLATE FOR HOSE

CHROME PLATED BRONZE FLANGE WITH BLACK PLASTIC CAP AND NECK

Complete with Fig. No. 1248 Key and O-Ring
Cap Has a Slot Between the Holes.



Fig. 547

ORDERING INFORMATION

Hose Size Inches	O.D. Flange Inches	Length Neck Inches	Display Pkg. - 5 Cards 1 Pc. per Card	OEM Bulk Pkg. 25 Pcs.	Screw Size	Weight Ounces
1-1/2	3-1/8	3-1/2	547 DP CHR	547 000 CHR	8	14
1-1/2	3-1/8	3-1/2	548 DP CHR	548 000 CHR	8	11

Spare Cap with O-Ring, Cat. No. 507 DP 99A.
Spare Cap with O-Ring, Cat. No. 508 DP 99A.

Spare O-Rings Only (2 per bag), Cat. No. 513 008.
Spare Key, Cat. No. 1248 7-8 DP.



Fig. 548

NOTE: These Items Comply with Adopted Standards on "Fittings" A.B.Y.C. Recommended Practices Standards Covering Sewage Holding and/or Treatment Devices for Marine Waste Systems.

DECK PLATES



Fig. 1269

FIG. 1269 - WASTE DECK PLATE FOR HOSE CHROME PLATED ZINC, BLACK PLASTIC CAP

Complete with Fig. No. 1248 Key and O-Ring
Cap Has a Slot Between the Holes.

ORDERING INFORMATION

Hose Size Inches	O.D. Flange Inches	Length Neck Inches	Display Pkg. - 5 Cards 1 Pc. per Card	OEM Bulk Pkg. 25 Pcs.	Screw Size	Weight Ounces
1-1/2	3-1/2	2-1/2	1269 DP CHR	1269 000 CHR	8	8

Spare Cap with O-Ring, Cat. No. 1269 DP 99A. Spare O-Rings Only (2 per bag), Cat. No. 513 008.
Spare Key, Cat. No. 1248 7-8 DP.

FIG. 527 - DECK PLATES FOR HOSE

CHROME PLATED BRONZE, 35° ANGLED HOSE BIBS

Complete with Fig. No. 1247 Key,
O-Ring and Fig. No. 537 Retaining Cable on Cap.
Caps Have A Slot Between the Holes.



Fig. 527

ORDERING INFORMATION

Marked For:	Hose Size Inches	O.D. Flange Inches	Length Neck Inches	Standard Pkg. - 1 Pc.	Screw Size	Weight Pounds
*Gas	1-1/2	3-1/2	4-7/8	527 G08 CHR	10	2-3/8
Diesel	1-1/2	3-1/2	4-7/8	527 D08 CHR	10	2-3/8

Spare Cap with O-Ring, Cat. No. 528 DP8 99A. Spare O-Rings Only (2 per bag), Cat. No. 513 008.
Spare Key, Cat. No. 1247 DP CHR.



Fig. 520

FIG. 520 - DECK PLATES FOR HOSE

CHROME PLATED BRONZE

FIG. 521 - DECK PLATES FOR HOSE

CHROME PLATED BRONZE WITH BLACK PLASTIC CAP

Complete with Fig. No. 1248 Key, O-Ring and Integral Retainer on Cap.
Caps Have A Slot Between the Holes.



Fig. 521

ORDERING INFORMATION

Marked For:	Hose Size Inches	O.D. Flange Inches	Length Neck Inches	Display Pkg. - 5 Cards 1 Pc. per Card	OEM Bulk Pkg. 25 Pcs.	Screw Size	Weight Ounces
*Gas	1-1/2	3-1/8	3-1/2	520 DPG CHR	520 G00 CHR	8	14
Diesel	1-1/2	3-1/8	3-1/2	520 DPD CHR	520 D00 CHR	8	14
Water	1-1/2	3-1/8	3-1/2	520 DPW CHR	520 W00 CHR	8	14
*Gas	1-1/2	3-1/8	3-1/2	521 DPG CHR	521 G00 CHR	8	11
Diesel	1-1/2	3-1/8	3-1/2	521 DPD CHR	521 D00 CHR	8	11
Water	1-1/2	3-1/8	3-1/2	521 DPW CHR	521 W00 CHR	8	11

Spare Cap with O-Ring and Retainer, Cat. No. 520 DP 99A.
Spare Diesel Cap with O-Ring and Retainer, Cat. No. 521 DPD 99A.
Spare O-Rings Only (2 per bag), Cat. No. 513 008

Spare Gas Cap with O-Ring and Retainer, Cat. No. 521 DPG 99A.
Spare Water Cap with O-Ring and Retainer, Cat. No. 521 DPW 99A.
Spare Key, Cat. No. 1248 7-8 DP.

*NOTE: These Items Meet the Requirements of U.S.C.G. Safety Standards, January 31, 1977, for Gasoline Fuel Systems, 33CFR183.

DECK PLATES & GAS FILL

FIG. 620 - DECK PLATES FOR HOSE

CHROME PLATED BRONZE CAP WITH BLACK PLASTIC NECK

FIG. 621 - DECK PLATES FOR HOSE

CHROME PLATED BRONZE FLANGE WITH BLACK PLASTIC CAP AND NECK

Complete with Fig. No. 1248 Key, O-Ring and Integral Retainer on Cap.
Caps Have A Slot Between the Holes.



Fig. 620



Fig. 621

ORDERING INFORMATION

Marked For:	Hose Size Inches	O.D. Flange Inches	Length Neck Inches	Display Pkg. - 5 Cards 1 Pc. per Card	OEM Bulk Pkg. 25 Pcs.	Screw Size	Weight Ounces
*Gas	1-1/2	3-1/8	3-1/2	620 DPG CHR	620 G00 CHR	8	14
Diesel	1-1/2	3-1/8	3-1/2	620 DPD CHR	620 D00 CHR	8	14
Water	1-1/2	3-1/8	3-1/2	620 DPW CHR	620 W00 CHR	8	14
*Gas	1-1/2	3-1/8	3-1/2	621 DPG CHR	621 G00 CHR	8	11
Diesel	1-1/2	3-1/8	3-1/2	621 DPD CHR	621 D00 CHR	8	11
Water	1-1/2	3-1/8	3-1/2	621 DPW CHR	621 W00 CHR	8	11

Spare Cap with O-Ring and Retainer, Cat. No. 520 DP 99A.
Spare Diesel Cap with O-Ring and Retainer, Cat. No. 521 DPD 99A.
Spare O-Rings Only (2 per bag), Cat. No. 513 008

Spare Gas Cap with O-Ring and Retainer, Cat. No. 521 DPG 99A.
Spare Water Cap with O-Ring and Retainer, Cat. No. 521 DPW 99A.
Spare Key, Cat. No. 1248 7-8 DP.

FIG. 1270 - DECK PLATE FOR HOSE

CHROME PLATED ZINC, BLACK PLASTIC CAP

Complete with Fig. No. 1248 Key, O-Ring and Integral Retainer on Cap.
Caps Have A Slot Between the Holes.



Fig. 1270

ORDERING INFORMATION

Marked For:	Hose Size Inches	O.D. Flange Inches	Length Neck Inches	Display Pkg. - 5 Cards 1 Pc. per Card	OEM Bulk Pkg. 25 Pcs.	Screw Size	Weight Ounces
*Gas	1-1/2	3-1/2	2-1/2	1270 DPG CHR	1270 G00 CHR	8	8
Diesel	1-1/2	3-1/2	2-1/2	1270 DPD CHR	1270 D00 CHR	8	8
Water	1-1/2	3-1/2	2-1/2	1270 DPW CHR	1270 W00 CHR	8	8

Spare Gas Cap with O-Ring and Retainer, Cat. No. 1270 DPG 99A.
Spare Diesel Cap with O-Ring and Retainer, Cat. No. 1270 DPD 99A.
Spare Water Cap with O-Ring and Retainer, Cat. No. 1270 DPW 99A.
Spare O-Rings Only (2 per bag), Cat. No. 513 008.
Spare Key, Cat. No. 1248 7-8 DP.

FIG. 1413 - GAS FILL

CHROME PLATED ZINC BLACK PLASTIC CAP AND BASE

Complete with Integral Cap Retainer/Gasket



Fig. 1413

ORDERING INFORMATION

For Hose Inches	Length Neck Inches	Dimensions Overall Inches	Display. Pkg. - 5 Cards. 1 Pc. per Card	Screw Size	Weight Ounces
1-1/2	1-7/8	3 x 3	*1413 DP CHR	6	7

Spare Cap, Cat. No. 126 DP BLK.

chromalex®

*NOTE: These Items Meet the Requirements of U.S.C.G. Safety Standards, January 31, 1977, for Gasoline Fuel Systems, 33CFR183.

FILLS



Fig. 1313

Figs. 1313 & 1399 - Gas Fills

PATENT No. 3,828,714

CHROME PLATED ZINC BLACK PLASTIC FLANGE AND CAP

Complete with Grounding Screw, Cap Retainer and Gasket.
Locking Cap Has a Cover for the Key Hole.

chromalex®

ORDERING INFORMATION

Marked For:	Hose Size Inches	O.D. Flange Inches	Length Neck Inches	Display Pkg. - 5 Cards 1 Pc. per Card	OEM Bulk Pkg. 50 Pcs.	Weight Ounces
*Gas	1-1/2	3-1/8	1-7/8	1313 DP CHR	1313 000 CHR	8
*Gas w/Lock	1-1/2	3-1/8	1-7/8	1399 DP CHR	1399 000 CHR	8

Screw Size #6.

Spare Non-Locking Cap, Cat. No. 126 DP BLK.

Spare Locking Cap with 2 keys, Cat. No. 1324 DP BLK.



Fig. 1399



Fig. 1613

Figs. 1613 - Plastic Gas Fill

BLACK PLASTIC FIBER REINFORCED, U.V. STABILIZED EASY-GRIP CAP

COMPLETE WITH O-RING AND CAP RETAINER.

No Deck Plate Key or Ground Wire Required.

ORDERING INFORMATION

For Hose Inches	O.D. Overall Inches	Length Neck Inches	Display Pkg. - 5 Cards 1 Pc. per Card	OEM Bulk Pkg. 50 Pcs.	Screw Size	Weight Ounces
1-1/2	3-1/16	2-7/16	1613 DP BLK*	*1613 000 BLK	8	4

Spare Cap with O-Ring and Retainer, Cat. No. 1613 000 99A.

Spare O-Rings (2 per bag), Cat. No. 513 008.



Fig. 1319

Figs. 1319 - Combination Gas Fill & Tank Vent

PATENT No. 5,275,213

BLACK OR WHITE PLASTIC INTEGRAL TANK VENT WITH FLAME ARRESTOR. FLIP TOP CAP

No Deck Plate Key or Ground Wire Required.

ORDERING INFORMATION

Marked For:	For Fuel Hose Inches	For Vent Hose Inches	Length Neck Inches	Display Pkg. - 10 Cards 1 Pc. per Card	OEM Bulk Pkg. 50 Pcs.	Screw Size	Weight Ounces
Gas	1-1/2	5/8	2-7/16	1319 DPG BLK*	1319 G00 BLK	10	4-1/2
Gas	1-1/2	5/8	2-7/16	1319 DPG WHT*	1319 G00 WHT	10	4-1/2
Diesel	1-1/2	5/8	2-7/16	1319 DPD BLK	1319 D00 BLK	10	4-1/2
Diesel	1-1/2	5/8	2-7/16	-----	1319 D00 WHT	10	4-1/2
Water	1-1/2	5/8	2-7/16	1319 DPW BLK	1319 W00 BLK	10	4-1/2
Water	1-1/2	5/8	2-7/16	-----	1319 W00 WHT	10	4-1/2

*NOTE: These Items Meet the Requirements of U.S.C.G. Safety Standards, January 31, 1977, for Gasoline Fuel Systems, 33CFR183.

FILLS

COMBINATION GAS FILL & TANK VENTS

PATENT NOS. 5,275,213 & 5,327,946



FIG. 540 - CHROME PLATED BRONZE CAP WITH BLACK PLASTIC BASE AND ANGLED NECK.

FIG. 541 - CHROME PLATED BRONZE CAP WITH BLACK PLASTIC BASE AND STRAIGHT NECK.

FIG. 542 - BLACK OR WHITE PLASTIC CAP WITH BLACK PLASTIC BASE AND ANGLED NECK.

FIG. 543 - BLACK OR WHITE PLASTIC CAP WITH BLACK PLASTIC BASE AND STRAIGHT NECK.

HEAVY DUTY STAINLESS STEEL BEAD CHAIN OR BLACK PLASTIC STRAP. INTEGRAL TANK VENT WITH FLAME ARRESTOR AND ANTI SURGE VALVE. Deck Plate Key Included. Ground Wire Required for Figs 540 and 541 only.



Fig. 540



Fig. 541



Fig. 542



Fig. 543

ORDERING INFORMATION

Marked For:	Cap Type	For Fuel Hose Inches	For Vent Hose Inches	Length Neck Inches	Display Pkg 5 Pcs.	OEM Bulk Pkg. 25 Pcs.	Screw Size	Weight Ounces
CHROME CAP & ANGLED NECK								
Gas	Chrome	1-1/2	5/8	2-7/16	540 DPG CHR*	540 G00 CHR*	8	4-1/2
Diesel	Chrome	1-1/2	5/8	2-7/16	540 DPD CHR	540 D00 CHR	8	4-1/2
Water	Chrome	1-1/2	5/8	2-7/16	540 DPW CHR	540 W00 CHR	8	4-1/2
CHROME CAP & STRAIGHT NECK								
Gas	Chrome	1-1/2	5/8	2-7/16	541 DPG CHR*	541 G00 CHR*	8	4-1/2
Diesel	Chrome	1-1/2	5/8	2-7/16	541 DPD CHR	541 D00 CHR	8	4-1/2
Water	Chrome	1-1/2	5/8	2-7/16	541 DPW CHR	541 W00 CHR	8	4-1/2
BLACK OR WHITE PLASTIC CAP & ANGLED NECK								
Gas	Black	1-1/2	5/8	2-7/16	542 DPG BLK*	542 G00 BLK*	8	4-1/2
Gas	White	1-1/2	5/8	2-7/16	542 DPG WHT*	542 G00 WHT*	8	4-1/2
Diesel	Black	1-1/2	5/8	2-7/16	542 DPD BLK	542 D00 BLK	8	4-1/2
Diesel	White	1-1/2	5/8	2-7/16	542 DPD WHT	542 D00 WHT	8	4-1/2
Water	Black	1-1/2	5/8	2-7/16	542 DPW BLK	542 W00 BLK	8	4-1/2
Water	White	1-1/2	5/8	2-7/16	542 DPW WHT	542 W00 WHT	8	4-1/2
BLACK OR WHITE PLASTIC CAP & STRAIGHT NECK								
Gas	Black	1-1/2	5/8	2-7/16	543 DPG BLK*	543 G00 BLK*	8	4-1/2
Gas	White	1-1/2	5/8	2-7/16	543 DPG WHT*	543 G00 WHT*	8	4-1/2
Diesel	Black	1-1/2	5/8	2-7/16	543 DPD BLK	543 D00 BLK	8	4-1/2
Diesel	White	1-1/2	5/8	2-7/16	543 DPD WHT	543 D00 WHT	8	4-1/2
Water	Black	1-1/2	5/8	2-7/16	543 DPW BLK	543 W00 BLK	8	4-1/2
Water	White	1-1/2	5/8	2-7/16	543 DPW WHT	543 W00 WHT	8	4-1/2



*NOTE: These Items Meet the Requirements of U.S.C.G. Safety Standards, January 31, 1977, for Gasoline Fuel Systems, 33CFR183.

DECK PLATE KEYS & CABLE



Fig. 1247

FIG. 1247 - DECK PLATE KEY

BLACK PLASTIC

Compact Size with Hole for Key Chain.
Will Fit PERKO 1-1/4" and 1-1/2" Deck Plates
and Many Other "Slot" Type Opening Deck Plates.

ORDERING INFORMATION



C. to C. of Lugs	Length Spade Inches	Length Overall Inches	Display Pkg. - 10 Bags 1 Pc. per Bag	Weight Ounces
1-1/8	1	1-3/4	1247 DP BLK	1



Fig. 1248

FIG. 1248 - DECK PLATE KEY

BLACK PLASTIC OR ZINC

The Keys For 1" Thru 1-1/2" Deck Plates Have a 1 Inch Spade on Handle
That Allows Them to Fit Many Other "Slot" Type Opening Deck Plates.

ORDERING INFORMATION

For Deck Plate Size Inches	C. to C. of Lugs	Length Overall Inches	Material	Display Pkg. 10 Bags 1 Pc. per Bag	Standard Pkg. - 10 Pc.	Weight Ounces
1	5/8	3-3/8	Plastic	-----	1248 006 BLK	1/2
1-1/4 & 1-1/2	1-1/8	3-3/8	Plastic	1248 7-8 DP	1248 7-8 BLK	1/2
2	1-11/16	4-3/8	Zinc	-----	1248 009 ZNC	2-1/2
2-1/2	2	4-3/8	Zinc	-----	*1248 010 ZNC	2-1/2

*Standard Pkg. - 1 pc.



Fig. 826

FIG. 826 - ADJUSTABLE DECK PLATE KEY

CHROME PLATED ZINC

Hardened Steel Pins
Will Fit Sizes up to 8 Inch Diameter

ORDERING INFORMATION

Length Overall Inches	Display Pkg. - 5 Cards 1 Pc. per Card	Weight Ounces
8-1/2	826 DP CHR	9-1/2



Fig. 537

FIG. 537 - RETAINING CABLE FOR DECK PLATES

STAINLESS STEEL CABLE AND FITTINGS WITH
1-3/8" STAINLESS STEEL RING AND SELF TAPPING SCREW

ORDERING INFORMATION

Length Cable Inches	Display Pkg. - 5 Cards 1 Pc. per Card	Weight Ounces
7	537 DP	1/2



DECK PLATE & FITTINGS

FIG. 526 - REGULAR DECK PLATE

**CAST BRONZE
PLAIN OR CHROME PLATED**

Complete with Key

ORDERING INFORMATION

I.D. Opening Inches	O.D. Overall Inches	Plain Bronze Standard Pkg. - 1 Pc.	Chrome Plated Bronze Standard Pkg. - 1 Pc.	Screw Size	Weight Pounds
3	5-3/8	526 003 PLB	526 003 CHR	10	2
4	7-1/16	526 004 PLB	526 004 CHR	10	3-3/8
5	8-3/8	526 005 PLB	526 005 CHR	10	4-3/4
6	9-3/8	526 006 PLB	526 006 CHR	1/4	7-1/2

Spare Parts Ordering Information

I.D. Opening Inches	Plain Bronze Cap	Chrome Plated Bronze Cap	Spare Key Only
3	526 P03 99A	526 C03 99A	539 003 ZNC
4	526 P04 99A	526 C04 99A	539 004 PLB
5	526 P05 99A	526 C05 99A	539 005 PLB
6	526 P06 99A	526 C06 99A	539 006 PLB

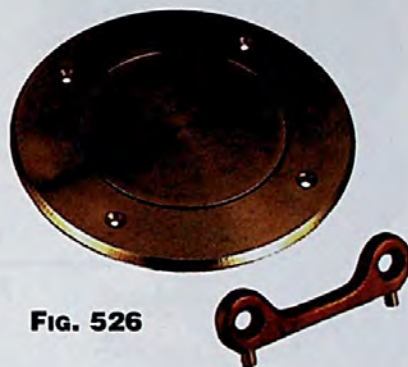

FIG. 526

FIG. 499 - WATER INLET FITTING

CHROME PLATED BRONZE

Standard Female Swivel Hose Connector. Complete With Black Plastic Watertight Plug and Stainless Steel Bead Chain. For Obtaining Water Under Pressure At Dockside.

ORDERING INFORMATION

Pipe Size Inches	O.D. Flange Inches	Display Pkg. - 5 Cards 1 Pc. per Card	OEM Bulk Pkg. 10 Pcs.	Screw Size	Weight Ounces
1/2	2-3/4	499 DP CHR	499 000 CHR	8	8

Spare Plug with Chain, Cat. No. 499 DP 99A.



FIG. 499

FIG. 504 - WATER OUTLET FITTING

CHROME PLATED BRONZE

Standard Male Hose Connector. Complete With Watertight Black Plastic Cap and Stainless Steel Bead Chain. For Use with On-board Washdown Systems.

ORDERING INFORMATION

Pipe Size Inches	O.D. Flange Inches	Display Pkg. - 5 Cards 1 Pc. per Card	OEM Bulk Pkg. 10 Pcs.	Screw Size	Weight Ounces
1/2	2-3/4	504 DP CHR	504 000 CHR	8	8

Spare Cap with Chain, Cat. No. 504 DP 99A.



FIG. 504

SCUPPERS



FIG. 343 - ADJUSTABLE THRU-HULL SCUPPER

MOLDED WHITE PLASTIC. SOFT BLACK FLAPPER VALVE

Designed for Surface Thickness from 2 inches to 4-3/4 inches.
Female portion of scupper can be cut down by one rib for each 1/4 inch difference between hull thickness and 4-3/4 inches.

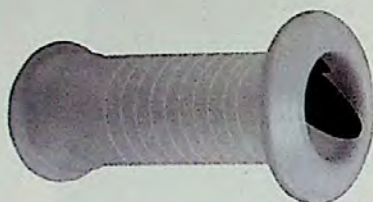

Fig. 343

ORDERING INFORMATION

I.D. Inches	Maximum Hull Thickness Inches	O.D. Flange Inches	OEM Bulk Pkg. 50 Pcs.	Weight Ounces
1-11/32	4-3/4	2-15/16	343	5

NOTE: Thru-Hull Connections For Use With Hose Are Not Recommended For Use Below The Waterline Per A.B.Y.C. "Safety Standards For Small Craft" Section H-27.



FIG. 333 - THRU-HULL SCUPPER WITH RECESSED FLAPPER

MOLDED WHITE PLASTIC. SOFT BLACK FLAPPER VALVE

Complete with Nut and Mounting Hardware.
For Mounting Through the Transom.

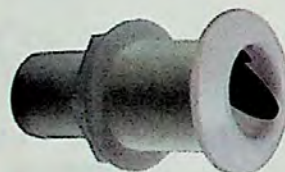

Fig. 333

ORDERING INFORMATION

Hose Size Inches	Maximum Hull Thickness Inches	O.D. Flange Inches	Display Pkg. - 5 Cards 1 Pc. per Card	OEM Bulk Pkg. 50 Pcs.	Weight Ounces
1-1/2	2-1/8	3	333 DP	333	5

Spare Flanged Nut See Fig. 326, on page 109.

NOTE: Thru-Hull Connections For Use With Hose Are Not Recommended For Use Below The Waterline Per A.B.Y.C. "Safety Standards For Small Craft" Section H-27.



FIG. 323 - THRU-HULL SCUPPER

MOLDED WHITE PLASTIC. SOFT BLACK FLAPPER VALVE

Complete with Nut and Mounting Hardware.
For Mounting Through the Transom.



Fig. 323

ORDERING INFORMATION

Hose Size Inches	Maximum Hull Thickness Inches	O.D. Flange Inches	Display Pkg. - 5 Cards 1 Pc. per Card	OEM Bulk Pkg. 50 Pcs.	Weight Ounces
1-1/2	2-1/8	2-7/8	323 DP	323	5

Spare Flanged Nut See Fig. 326, on page 109.

NOTE: Thru-Hull Connections For Use With Hose Are Not Recommended For Use Below The Waterline Per A.B.Y.C. "Safety Standards For Small Craft" Section H-27.



FIG. 365 - SCUPPER VALVE ASSEMBLY

MOLDED WHITE PLASTIC. SOFT BLACK FLAPPER VALVE

Without Thru-Hull and Mounting Hardware.

For Surface Mount Applications.



Fig. 365

ORDERING INFORMATION

O.D. Flange Inches	Display Pkg. - 5 Cards 1 Pc. per Card	OEM Bulk Pkg. 50 Pcs.	Screw Size	Weight Ounces
2-7/8	365 DP	365	6	1

SCUPPERS & THRU-HULL CONNECTIONS

FIG. 142 - COCKPIT SCUPPER

**CAST BRONZE, PLAIN OR CHROME PLATED
RUBBER CHECK BALL**

Complete with Key
For Use When Discharge is Below the Waterline.
Angle of Outlet is 45 Degrees.

ORDERING INFORMATION

Hose Size Inches	O.D. Grate Inches	O.D. Flange Inches	Plain Bronze Std. Pkg. - 1 Pc.	Chrome Plated Bronze Std. Pkg. - 1 Pc.	Weight Pounds
1	1-13/16	3-1/4	142 001 PLB	142 001 CHR	1-1/2
1-1/2	2-1/4	3-5/8	142 002 PLB	*142 002 CHR	2-5/8

Screw Size #8

* O.E.M. Bulk Pkg. - 10 pcs.

SPARE PARTS ORDERING INFORMATION

Hose Size Inches	Plain Bronze Grate	Chrome Plated Bronze Grate	Check Ball Only	Spare Key Only
1	142 P01 99A	142 C01 99A	142 001 99B	1248 7-8 DP
1-1/2	142 P02 99A	142 C02 99A	142 002 99B	1248 7-8 DP



FIG. 142



FIG. 285 - COCKPIT SCUPPER

MOLDED WHITE PLASTIC - FLUSH MOUNT

For Use When Discharge is Above the Waterline.
Insert Prevents Passage of Large Objects without Restricting Water Flow.

ORDERING INFORMATION

Hose Size Inches	Maximum Hull Thickness Inches	O.D. Flange Inches	I.D. Inches	Display Pkg. - 5 Cards 1 Pc. per Card	OEM Bulk Pkg. 50 Pcs.	Weight Ounces
1-1/2	1-3/4	2-3/4	1-1/2	285 DP	285	5

Spare Flanged Nut See Fig. 326, on page 109.



FIG. 285

FIG. 322 - THRU-HULL CONNECTION

CAST BRONZE

Flange is Machined to Fit Hull and Grooved to Retain Bedding Compound.
Neck is Threaded to Approximately 3/8 inches from Flange.

ORDERING INFORMATION

Pipe Size Inches	Maximum Hull Thickness Inches	O.D. Flange Inches	Display Pkg. - 5 Cards 1 pc. per Card	Standard Package - 1 Pc.	OEM Bulk Pkg. 25 Pcs.	Weight Pounds
3/8	1-3/4	1-7/16	322 DP3 PLB	-----	322 003 PLB	3/8
1/2	1-3/8	1-1/2	322 DP4 PLB	-----	322 004 PLB	3/8
3/4	1-1/2	1-7/8	322 DP5 PLB	-----	322 005 PLB	1/2
1	1-7/8	2-3/16	322 DP6 PLB	-----	322 006 PLB	7/8
1-1/4	2	2-3/4	322 DP7 PLB	-----	322 007 PLB	1-1/8
1-1/2	2-1/4	3	322 DP8 PLB	-----	*322 008 PLB	1-3/4
2	2-3/8	3-5/8	-----	322 009 PLB	-----	2
2-1/2	2-5/8	4-1/2	-----	322 010 PLB	-----	3-1/2
3	2-3/4	5	-----	322 011 PLB	-----	5

* O.E.M. Bulk Pkg. - 10 pcs.

Spare Flanged Nut See Fig. 75, on page 109.



FIG. 322

THRU - HULL CONNECTIONS

FIG. 348 - EXTRA LONG THRU-HULL CONNECTION



CAST BRONZE

Flange is Machined to Fit Hull and Grooved to Retain Bedding Compound.
Neck is Threaded to Approximately 3/8 Inch From Flange.



Fig. 348

ORDERING INFORMATION

Pipe Size Inches	Maximum Hull Thickness Inches	O.D. Flange Inches	Standard Package - 5 Pcs.	OEM Bulk Pkg.	Weight Pounds
3/4	5	1-7/8	348 005 PLB	25	7/8
1	4-7/8	2-1/4	348 006 PLB	10	1-1/4
1-1/4	4-5/8	2-3/4	348 007 PLB	10	2-1/8
1-1/2	4-5/8	3	348 008 PLB	10	2-1/4
2	4-1/2	3-5/8	348 009 PLB	---	3
2-1/2	4-1/4	4-5/16	348 010 PLB	---	4

Spare Flanged Nut See Fig. 75, on page 109.

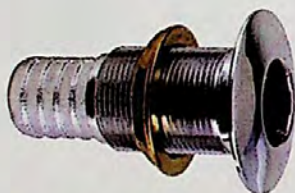

FIG. 350 - THRU-HULL CONNECTION

CAST BRONZE PLAIN OR CHROME PLATED FOR USE WITH HOSE**

FIG. 350 CHROME

Flange is Machined to Fit Hull and Grooved to Retain Bedding Compound.
Neck is Threaded to Approximately 3/8 Inch From Flange.



FIG. 350 PLAIN

ORDERING INFORMATION

Hose Size Inches	Maximum Hull Thickness Inches	O.D. Flange Inches	Plain Bronze Display Pkg. - 5 Cards 1 Pc. per Card	Chrome Plated Bronze Display Pkg. - 5 Cards 1 Pc. per Card	Plain Bronze OEM Bulk Pkg. 10 Pcs.	Chrome Plated Bronze OEM Bulk Pkg. 10 Pcs.	Weight Pounds
5/8	1-1/16	1-1/2	350 004 DPP	350 004 DPC	350 004 PLB	350 004 CHR	3/8
3/4	1-5/8	1-7/8	350 005 DPP	350 005 DPC	350 005 PLB	350 005 CHR	1/2
1	1-3/4	2-1/4	350 006 DPP	350 006 DPC	350 006 PLB	350 006 CHR	7/8
1-1/8	1-3/4	2-1/4	350 06A DPP	350 06A DPC	350 06A PLB	350 06A CHR	7/8
1-1/4	1-7/8	2-3/4	350 007 DPP	350 007 DPC	350 007 PLB	350 007 CHR	1-3/8
1-1/2	1-7/8	3-1/8	350 008 DPP	350 008 DPC	350 008 PLB	350 008 CHR	1-1/2

Spare Flanged Nut See Fig. 75, on page 109.

**NOTE: Thru-Hull Connections For Use With Hose Are Not Recommended For Use Below The Waterline Per A.B.Y.C. "Safety Standards For Small Craft" Section H-27.

THRU-HULL CONNECTIONS

FIG. 301 - THRU-HULL CONNECTION

**MOLDED WHITE PLASTIC
NARROW FLANGE
FOR USE WITH HOSE****



ORDERING INFORMATION

Hose Size Inches	Maximum Hull Thickness Inches	O.D. Flange Inches	Display Pkg. - 10 Cards 1 Pc. per Card	OEM Bulk Pkg. 100 Pcs.	Weight Ounces
1/2	1-1/4	1-1/4	301 DP4	301 004	1
5/8	1-1/4	1-1/4	301 DP4A	301 04A	1
3/4	1-7/16	1-1/2	301 DP5	301 005	1-1/2
1	1-1/2	1-7/8	*301 DP6	***301 006	2
1-1/8	1-1/2	1-7/8	*301 DP6A	***301 06A	2
1-1/2	1-7/8	2-1/2	*301 DP8	***301 008	4

* Display Pkg. - 5 pcs.

** OEM Bulk Pkg. - 50 pcs.

Spare Flanged Nut See Fig. 326.



Fig. 301

FIG. 328 - THRU-HULL CONNECTION

**MOLDED WHITE PLASTIC
BROAD FLANGE
FOR USE WITH HOSE****



ORDERING INFORMATION

Hose Size Inches	Maximum Hull Thickness Inches	O.D. Flange Inches	Display Pkg. - 10 Cards 1 Pc. per Card	OEM Bulk Pkg. 100 Pcs.	Weight Ounces
1/2	1-1/4	1-1/2	328 DP4	328 004	1
5/8	1-1/4	1-1/2	328 DP4A	328 04A	1
3/4	1-7/16	2-1/16	328 DP5	328 005	1-1/2
1	1-1/2	2-1/4	*328 DP6	***328 006	2
1-1/8	1-1/2	2-1/4	*328 DP6A	***328 06A	2
1-1/2	1-7/8	3	*328 DP8	***328 008	4

* Display Pkg. - 5 Pcs.

** OEM Bulk Pkg. - 50 Pcs.

Spare Flanged Nut See Fig. 326.



Fig. 328

FIG. 75 - SPARE FLANGED LOCK NUT - CAST BRONZE

FIG. 326 - SPARE FLANGED LOCK NUT - MOLDED WHITE PLASTIC

ORDERING INFORMATION

Pipe Size Inches	Cast Bronze Nut	Standard Pkg. Pcs.	Molded White Plastic Display Pkg. - 10 Pcs.	Molded White Plastic OEM Bulk Pkg.	Bulk Pkg. Qty.
3/8	75 003 PLB	5	-----	-----	----
1/2	75 004 PLB	5	326 DP4	326 004	100
3/4	75 005 PLB	5	326 DP5	326 005	100
1	75 006 PLB	5	326 DP6	326 006	50
1-1/4	75 007 PLB	5	-----	-----	----
1-1/2	75 008 PLB	1	326 DP8	326 008	50
2	75 009 PLB	1	-----	-----	----
2-1/2	75 010 PLB	1	-----	-----	----
3	75 011 PLB	1	-----	-----	----



Fig. 75



Fig. 326

**NOTE: Thru-Hull Connections For Use With Hose Are Not Recommended For Use Below The Waterline Per A.B.Y.C. "Safety Standards For Small Craft" Section H-27.

SEACOCKS

FIGS. 834 & 835 - SEACOCKS

Fig. 834



BALL VALVE DESIGN

CAST BRONZE



Complete with Thru-Hull, Hose Adapter, Drain Plug, Four Pre-Drilled Mounting Holes and Bonding Screw.

FIG. 834 - WITH 90° CURVED HOSE ADAPTER.

FIG. 835 - WITH STRAIGHT HOSE ADAPTER.

PERKO Seacocks Incorporate a Plastic Ball and Seat Assuring a Tight Seal and Ease of Operation. Drain Plugs for Winterizing. Handles are Easily Removed.

ORDERING INFORMATION



Fig. 835

Hose Size Inches	Pipe Size Inches	Fig. 834 Standard Package - 1 Pc.	Fig. 835 Standard Package - 1 Pc.	OEM Bulk Pkg.	Bolt Size	Weight Pounds
3/4	3/4	834 005 PLB	835 005 PLB	5	5/16	3-1/8
1	1	834 006 PLB	835 006 PLB	---	3/8	5-1/8
1-1/4	1-1/4	834 007 PLB	835 007 PLB	5	3/8	6-3/4
1-1/2	1-1/2	834 008 PLB	835 008 PLB	5	3/8	10
2	2	834 009 PLB	835 009 PLB	---	3/8	22
2-1/2	2-1/2	834 010 PLB	835 010 PLB	---	1/2	25
3	3	834 011 PLB	835 011 PLB	---	1/2	32

FIG. 805 - SEACOCK BODY

BALL VALVE DESIGN

CAST BRONZE



These Valve Bodies are Offered to Meet the Needs of Applications that Require Extra Long, Scoop or Flush Type Thru-Hulls.

ORDERING INFORMATION



Fig. 805

Pipe Size Inches	Fig. 805 Standard Package - 1 Pc.	OEM Bulk Pkg.	Weight Pounds
3/4	805 005 PLB	5	2-1/2
1	805 006 PLB	5	4
1-1/4	805 007 PLB	5	5-1/8
1-1/2	805 008 PLB	5	6-3/8
2	805 009 PLB	---	11-3/8
2-1/2	805 010 PLB	---	19
3	805 011 PLB	---	24

SPARE PARTS ORDERING INFORMATION

The Repair Kits Listed Below Consist of: 1 Ball, 2 Ball Seats and 2 O-Rings for the Valve Stem.

Pipe Size Inches	Repair Kit	Pipe Size Inches	Repair Kit	Pipe Size Inches	Repair Kit
3/4	805 005 99B	1-1/2	805 008 99B	3	805 011 99B
1	805 006 99B	2	805 009 99B		
1-1/4	805 007 99B	2-1/2	805 010 99B		

INLINE VALVE & PIPE TO HOSE ADAPTERS

FIG. 825 - INLINE VALVE

CAST BRONZE

Complete with Drain Plug and Bonding Screw.
Ball Valve for Smooth Operation.

ORDERING INFORMATION

Pipe Size Inches	Standard Package - 1 Pc.	OEM Bulk Pkg.	Weight Pounds
1/2	825 004 PLB	10	1
3/4	825 005 PLB	10	1-1/4
1	825 006 PLB	10	1-3/4
1-1/4	825 007 PLB	10	2-3/4
1-1/2	825 008 PLB	5	4-1/4



FIG. 825

FIG. 63 - PIPE TO HOSE ADAPTER

CAST BRONZE CURVED 90 DEGREES

ORDERING INFORMATION

Pipe Size Inches	Hose Size Inches	Length Overall Inches	Standard Package - 1 Pc.	OEM Bulk Pkg.	OEM Bulk Pcs./Pkg.	Weight Pounds
3/4	3/4	4-1/2	63 005 PLB	63 005 PLB	25	1/2
1	1	4-3/4	63 006 PLB	63 006 PLB	25	3/4
1-1/4	1-1/4	5-1/2	63 007 PLB	63 007 PLB	25	1
1-1/2	1-1/2	6	63 008 PLB	63 008 PLB	10	1-1/4
2	2	7	63 009 PLB	-----	---	2-1/2
2-1/2	2-1/2	8-1/2	63 010 PLB	-----	---	3-7/8
3	3	10	63 011 PLB	-----	---	6-3/8



FIG. 63

NOTE: The Above Item Meets the Requirements of U.S.C.G. Safety Standards, January 31, 1977 for Gasoline Fuel Systems, 33CFR183.

FIG. 76 - PIPE TO HOSE ADAPTER

CAST BRONZE

ORDERING INFORMATION

Pipe Size Inches	Hose Size Inches	Length Overall Inches	Display Pkg. - 5 Cards 1 Pc. per Card	Standard Package - 1 Pc.	OEM Bulk Pkg. 25 Pcs.	Weight Pounds
1/2	5/8	1-5/8	76 DP4 PLB	-----	76 004 PLB	1/8
3/4	3/4	1-3/4	76 DP5 PLB	-----	76 005 PLB	1/4
1	1	1-3/4	76 DP6 PLB	-----	76 006 PLB	3/8
1-1/4	1-1/4	2	76 DP7 PLB	-----	76 007 PLB	1/2
1-1/2	1-1/2	2-1/4	76 DP8 PLB	-----	76 008 PLB	3/4
2	2	2-5/8	-----	76 009 PLB	-----	1
2-1/2	2-1/2	4	-----	76 010 PLB	-----	2-1/8
3	3	5-1/8	-----	76 011 PLB	-----	3



FIG. 76

NOTE: The Above Item Meets the Requirements of U.S.C.G. Safety Standards, January 31, 1977 for Gasoline Fuel Systems, 33CFR183.



Fig. 65

Pipe Size Inches	Maximum Hull Thickness Inches	Dimensions Strainer Inches	Display Pkg. - 5 Cards 1 Pc. per Card	Standard Package - 1 Pc.	OEM Bulk Pkg. 10 Pcs.	Weight Pounds
1/2	2-1/4	3 x 4	-----	65 004 PLB	65 004 PLB	3/4
3/4	2-3/16	3 x 4	65 DP5 PLB	-----	65 005 PLB	1
1	2-1/2	3 x 4	-----	65 006 PLB	65 006 PLB	1-1/4
1-1/4	3	3-1/4 x 4-1/4	-----	65 007 PLB	65 007 PLB	2

Screw Size #8.

Spare Flanged Nut See Fig. 75, on page 109.

Fig. 65 - INTAKE STRAINER

CAST BRONZE



ORDERING INFORMATION

Fig. 66 - SCOOP STRAINER



Fig. 66

For Thru-Hull Sizes Inches	Dimensions Strainer Inches	Standard Package - 5 Pc.	Weight Pounds
3/8 & 1/2	3-1/2 x 2-1/2	66 001 PLB	1-3/4
3/4 & 1	5 x 3-1/4	66 002 PLB	4-1/2
1-1/4 & 1-1/2	6-1/4 x 4-1/4	66 003 PLB	6-3/8
2	8 x 5-1/8	66 004 PLB	10

Screw Size #8.

CAST BRONZE

ORDERING INFORMATION



Fig. 86 - ROUND STRAINER



Fig. 86

For Thru-Hull Sizes Inches	O.D. Inches	I.D. Inches	Display Pkg. - 5 Cards 1 Pc. per Card	Standard Package - 5 Pcs.	Screw Size	Weight Pounds
3/8 & 1/2	2-1/2	1-5/8	-----	86 001 PLB	8	3/16
3/4	3	2	86 DP2 PLB	86 002 PLB	8	1/4
1	3-1/2	2-3/8	-----	86 003 PLB	8	3/8
1-1/4 x 1-1/4	4	3	-----	86 004 PLB	8	1/2
2	5	3-3/4	-----	86 005 PLB	8	3/4
2-1/2	6	4-1/2	-----	*86 006 PLB	10	1-1/4
3	8	6-1/4	-----	*86 007 PLB	10	2-1/2

* Standard Package - 1 pc.

CAST BRONZE

ORDERING INFORMATION



PUMP STRAINERS



FIG. 709 - PUMP STRAINER

CAST BRONZE

ORDERING INFORMATION

Hose Size Inches	Length Overall Inches	Width Overall Inches	Display Pkg. - 5 Cards 1 Pc. per Card	Weight Ounces
5/8	3-5/8	1-3/4	709 DP PLB	6



FIG. 709

FIG. 704 & 705 - PUMP STRAINERS

CAST BRONZE

ORDERING INFORMATION

Hose Size Inches	Length Overall Inches	Width Overall Inches	Standard Package - 1 Pc.	Weight Pounds
1-1/4	6-3/8	2-3/4	704 000 PLB	2
1-1/4	4-1/2	2-3/4	705 000 PLB	1-1/2



FIG. 704



FIG. 705

FIG. 721 & 722 - PUMP STRAINERS

CAST BRONZE

ORDERING INFORMATION

Pipe Size Inches	Length Overall Inches	Width Overall Inches	Standard Package - 1 Pc.	Weight Pounds
1-1/4	4-3/4	2-3/4	721 000 PLB	1-3/4
1-1/4	4-1/2	2-3/4	722 000 PLB	1-3/8



FIG. 721



FIG. 722

STRAINERS & FILTERS, PIPE & HOSE DECK PLATES AND UNDERWATER FITTINGS

FUEL FILTER & SEPARATOR & GARBOARD DRAIN PLUG

FIG. 299 - FUEL FILTER AND SEPARATOR

CAST BRONZE

MICROPOROUS FILTER ELEMENT

Complete with Adjustable Mounting Bracket, Drain Plug and O-Ring.
These Units Separate Water From Gasoline or Diesel Fuel and
Filter Out Particles of 40 Microns or Larger in Size.

ORDERING INFORMATION

Pipe Size Inches	Height Overall Inches	O.D. Overall Inches	Standard Package - 1 Pc.	Dimensions Element Inches	Screw Size	Weight Pounds
3/8	5-1/2	2-3/8	299 001 PLB	1-3/4 x 1-3/4	8	3-3/4
1/2	6-1/4	3-1/8	299 002 PLB	2-1/4 x 2	10	5-1/2

Spare Element and O-Ring for 3/8", Cat. No. 324 001 ELM.
Spare Element and O-Ring for 1/2", Cat. No. 324 002 ELM.



FIG. 299



NOTE: This Item Meets the Requirements of U.S.C.G. Safety Standards, January 31, 1977, for Gasoline Fuel Systems, 33CFR183.



FIG. 124 - GARBOARD DRAIN PLUG

CAST BRONZE FLANGE

BRASS PLUG

Complete with Zinc Plated Steel Wrench.

ORDERING INFORMATION



FIG. 124

Pipe Size Inches	Length Threaded Neck Inches	O.D. Flange Inches	Standard Package - 5 Pcs.	Screw Size	Weight Pounds
1	1	3-1/8	124 000 PLB	10	1-1/4

Spare Wrench, Cat. No. 124 000 99A.

Spare Plug, Cat. No. 124 000 99B.

GARBOARD DRAIN PLUGS



FIG. 266 - GARBOARD DRAIN PLUG

CAST BRONZE

ORDERING INFORMATION

Pipe Size Inches	Length Threaded Neck Inches	O.D. Flange Inches	Display Pkg. - 5 Cards 1 Pc. per Card	Screw Size	Weight Ounces
3/4	5/8	2-3/8	266 DP PLB	8	12

Spare Plug, Cat. No. 370 DP PLB.



Fig. 266



FIG. 363 - GARBOARD DRAIN PLUG

CAST BRONZE

ORDERING INFORMATION

Pipe Size Inches	Maximum Hull Thickness Inches	Length Threaded Neck Inches	O.D. Flange Inches	Display Pkg. - 5 Cards 1 Pc. per Card	OEM Bulk Pkg. 25 Pcs.	Weight Ounces
3/4	3/4	1-1/4	2-3/8	363 DP PLB	363 000 PLB	15

Spare Plug, Cat. No. 370 DP PLB.



Fig. 363



FIG. 714 - GARBOARD DRAIN PLUG

CAST BRONZE FLANGE WITH BRASS PLUG

No. 2 Style has Stainless Steel Pin.

ORDERING INFORMATION

Pipe Size Inches	O.D. Flange Inches	Display Pkg. - 5 Cards 1 Pc. per Card	OEM Bulk Pkg. 50 Pcs.	Screw Size	Weight Ounces
1/2	2	714 DP1 PLB	714 001 PLB	8	4
1/2	2	714 DP2 PLB	714 002 PLB	8	4

Spare No. 1 Plug, Cat. No. 742 DP1. Spare No. 2 Plug, Cat. No. 742 DP2.



Fig. 714 No. 1



Fig. 714 No. 2



FIG. 737 - GARBOARD DRAIN PLUG

CAST BRONZE FLANGE WITH BRASS PLUG

Complete with Brass Backing Plate and Fasteners.

No. 2 Style has Stainless Steel Pin.

ORDERING INFORMATION

Pipe Size Inches	Maximum Hull Thickness Inches	O.D. Flange Inches	Display Pkg. - 5 Cards 1 Pc. per Card	Screw Size	Weight Ounces
1/2	7/16	2	737 DP1 PLB	8-32	5
1/2	7/16	2	737 DP2 PLB	8-32	5

Spare No. 1 Plug, Cat. No. 742 DP1. Spare No. 2 Plug, Cat. No. 742 DP2.



Fig. 737 No. 1



Fig. 737 No. 2

SAILMAKER'S PALM, CAULKING IRON & SCRAPER



Fig. 411

FIG. 411 - SAIL MAKER'S PALM

**LEATHER
RIGHT HAND**

ORDERING INFORMATION

Display Pkg. - 5 Cards	Weight
1 Pc. per Card	Ounces
411 DP	2



FIG. 307 - CAULKING IRON



Fig. 307

MALLEABLE IRON

ORDERING INFORMATION

Thickness Blade Inches	Width Blade Inches	Length Overall Inches	Standard Package - 10 Pcs.	Weight Ounces
1/32	2	5	307 000	5
1/16	2-1/2	5-5/8	307 00A	6-1/2
1/8	2-1/4	5-7/8	307 001	7

FIG. 1175 - DOUBLE ENDED SCRAPER

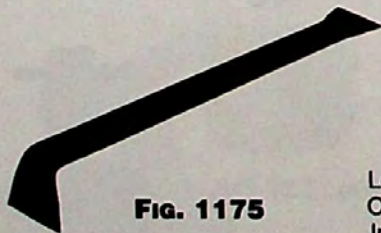

Fig. 1175

HEAT TREATED STEEL

ORDERING INFORMATION

Length Overall Inches	Width Blade Inches	Width Shank Inches	Thickness Shank Inches	Standard Package - 5 Pcs.	Weight Pounds
15	1-3/4	1	1/4	1175	1

CLEATS

FIG. 566 - CLOSED BASE CLEAT



CHROME PLATED ZINC

ORDERING INFORMATION

Length Overall Inches	Dimensions Base Inches	Max. Rope Size Inches	Display Pkg. - 5 Cards 2 Pcs. per Card	Screw Size	Weight Ounces
2	2-3/16 x 1-1/8	5/16	566 DP2 CHR	6	1-1/2
3	3-1/8 x 1-1/2	3/8	566 DP3 CHR	8	4-1/2
4-1/2	4-7/16 x 1-7/8	1/2	566 DP4 CHR	10	8-1/2
6	5-1/2 x 2	3/4	*566 DP6 CHR	12	13-1/2



Fig. 566

* Display Pkg. 5 pcs., 1 Pc. per card

FIG. 1252 - OPEN BASE CLEAT



CHROME PLATED ZINC

ORDERING INFORMATION

Length Overall Inches	Dimensions Base Inches	Max. Rope Size Inches	Display Pkg. - 5 Cards 2 Pcs. per Card	OEM Bulk Pkg. 50 Pcs.	Screw Size	Weight Ounces
6-1/2	3 x 1-1/8	3/4	1252 DP CHR	1252 000 CHR	1/4	7



Fig. 1252

FIG. 530 - OPEN BASE CLEAT



PLAIN ALUMINUM

ORDERING INFORMATION

Length Overall Inches	Dimensions Base Inches	Max. Rope Size Inches	Standard Package - 1 Pc.	Screw Size	Weight Pounds
8	4 x 2-1/4	3/4	530 008 ALU	1/2	1-1/8
10	4-1/2 x 3	7/8	530 010 ALU	1/2	1-3/4
12	6-1/2 x 2-7/8	1	530 012 ALU	5/8	3-1/2
15	7 x 3-1/4	1-1/2	530 015 ALU	3/4	4-7/8



Fig. 530

DECK HARDWARE, CLEATS, CHOCKS, BITTS, BOW EYES, ROWLOCKS, WINDSHIELD & HATCH ADJUSTERS

CLEATS



FIG. 572 - OPEN BASE CLEAT



FIG. 572

CHROME PLATED BRONZE

ORDERING INFORMATION

Length Overall Inches	Dimensions Base Inches	Max. Rope Size Inches	Display Pkg. - 5 Cards 1 Pc. per Card	Standard Package - 1 Pc.	OEM Bulk Pkg. 10 Pcs.	Screw Size	Weight Pounds
8	4 x 2-1/4	3/4	572 DP8 CHR	-----	572 008 CHR	1/4	1-1/4
10	5-1/16 x 2-13/16	7/8	-----	572 010 CHR	-----	5/16	1-3/4
12	6-1/16 x 2-7/8	1	-----	572 012 CHR	-----	5/16	2-1/2
15	7-3/8 x 3-5/8	1-1/2	-----	572 015 CHR*	-----	3/8	7-1/4

* New Item



FIG. 1188 - OPEN BASE CLEAT



FIG. 1188

CHROME PLATED ZINC

ORDERING INFORMATION

Length Overall Inches	Dimensions Base Inches	Max. Rope Size Inches	Display Pkg. - 5 Cards 1 Pc. per Card	Catalog Number	Std. Pkg.	OEM Bulk Pkg.	Screw Size	Weight Pounds
4	2-1/8 x 1-1/2	5/16	*1188 DP4 CHR	1188 004 CHR	---	50	10	1/4
6	3 x 1-3/4	7/16	1188 DP6 CHR	1188 006 CHR	---	50	10	1/2
8	4 x 2-1/8	5/8	1188 DP8 CHR	1188 008 CHR	---	25	1/4	3/4
10	5 x 2-3/8	7/8	-----	1188 010 CHR	1	10	1/4	1-1/2
12	6 x 3	1	-----	1188 012 CHR	1	10	5/16	2-1/2

* Display Package, 5 cards - 2 Pcs. per card.

FIG. 1210 - OPEN BASE CLEAT

**CHROME PLATED ZINC
ZINC PLATED STEEL STUDS,
NUTS AND WASHERS**



FIG. 1210

ORDERING INFORMATION

Length Overall Inches	Dimensions Base Inches	Max. Rope Size Inches	Catalog Number	Std. Pkg.	OEM Bulk Pkg.	Stud Size	Weight Ounces
4	2-1/8 x 1-1/2	5/16	1210 004 CHR	10	50	12-24 x 1-1/4	5-1/2
6	3 x 1-3/4	7/16	1210 006 CHR	10	30	1/4-20 x 2	8
8	4 x 2-1/8	5/8	1210 008 CHR	5	30	1/4-20 x 2	12-1/2

CLEATS

FIG. 545 - CLEAT



PLAIN ALUMINUM



FIG. 545

ORDERING INFORMATION

Length Overall Inches	Dimensions Base Inches	Max. Rope Size Inches	Display Pkg. - 5 Cards 2 Pcs. per Card	Standard Package - 5 Pcs.	Screw Size	Weight Ounces
3	1-1/2 x 5/8	1/4	545 DP3 ALU	-----	8	1-1/2
4	1-5/8 x 3/4	5/16	545 DP4 ALU	-----	10	2
5	2 x 7/8	3/8	545 DP5 ALU	-----	1/4	3
6	2-1/4 x 7/8	7/16	**545 DP6 ALU	-----	1/4	4
*8	2-5/8 x 1-7/8	5/8	**545 DP8 ALU	-----	1/4	5
*10	3-5/8 x 1-1/2	3/4	-----	545 010 ALU	5/16	9
*12	4 x 1-1/2	7/8	-----	545 012 ALU	5/16	14

* These Sizes are Open Base, Balance of Sizes are Closed Base.

** Display Package, 10 pcs., 1 Pc. per card.

FIG. 544 - CLEAT



CAST BRONZE POLISHED OR CHROME PLATED



FIG. 544

ORDERING INFORMATION

Length Overall Inches	Dimensions Base Inches	Max. Rope Size Display Pkg.	Chrome Plated Bronze Display Pkg.	Display Pkg. - 5 Cards Pcs. per Card	Polished Bronze Standard Pkg.	Chrome Plated Bronze Standard Pkg.	Std. Pkg.	Screw Size
3	1-1/2 x 5/8	1/4	544 DP3 CHR	2	544 003 POL	-----	10	8
4	1-5/8 x 3/4	5/16	544 DP4 CHR	1	544 004 POL	-----	5	10
5	2 x 7/8	3/8	-----	---	544 005 POL	544 005 CHR	5	1/4

CLEATS



Fig. 1305

FIG. 1305 - CLOSED BASE CLEAT

**CHROME PLATED ZINC
BLACK PLASTIC BASE**

chromalex®

ORDERING INFORMATION

Length Overall Inches	Max. Rope Size Inches	Display Package	Display Pkg. - 5 Cards Pcs. per Card	OEM Bulk Pkg. 50 Pcs.	Screw Size	Weight Ounces
4-1/2	3/8	1305 DP1 CHR	2	1305 001 CHR	10	5
6	1/2	1305 DP2 CHR	1	1305 002 CHR	1/4	10

FIG. 1315 - CLOSED BASE CLEAT

**CHROME PLATED ZINC. BLACK PLASTIC BASE
ZINC PLATED STEEL STUDS, NUTS AND WASHERS**

chromalex®

ORDERING INFORMATION



Fig. 1315

Length Overall Inches	Max. Rope Size Inches	Catalog Number	Standard Package	OEM Bulk Package	Stud Size	Weight Ounces
4-1/2	3/8	1315 001 CHR	10	50	12-24 x 1-1/2	6-1/2
6	1/2	1315 002 CHR	5	40	1/4 x 1-1/2	12

FIG. 1316 - OPEN BASE CLEAT

**CHROME PLATED ZINC. BLACK PLASTIC BASE
ZINC PLATED STEEL STUDS, NUTS AND WASHERS**

chromalex®

ORDERING INFORMATION



Fig. 1316

Length Overall Inches	Max. Rope Size Inches	Catalog Number	Std. Pkg.	OEM Bulk Pkg.	Stud Size	Weight Ounces
4-1/2	3/8	1316 001 CHR	10	50	12-24 x 1-1/2	5
6	1/2	1316 002 CHR	5	40	1/4 x 1-1/2	10-1/2

FIG. 1416 - OPEN BASE CLEAT

**CHROME PLATED ZINC
BLACK PLASTIC BASE AND INSERT
ZINC PLATED STEEL STUDS, NUTS AND WASHERS**

chromalex®

ORDERING INFORMATION



Fig. 1416

Length Overall Inches	Max. Rope Size Inches	Catalog Number	Std. Pkg.	OEM Bulk Pkg.	Stud Size	Weight Ounces
4-1/2	3/8	1416 001 CHR	10	50	12-24 x 1-1/2	5
6	1/2	1416 002 CHR	5	40	1/4 x 1-1/2	10-1/2
8	3/4	1416 003 CHR	1	30	1/4 x 1-1/2	13

DECK HARDWARE, CLEATS, CHOCKS, BITTS, BOW EYES, ROWLOCKS, WINDSHIELD & HATCH ADJUSTERS

CLEATS



FIG. 1306 - OPEN BASE CLEAT

**CHROME PLATED ZINC
BLACK PLASTIC BASE**

chromalex®



Fig. 1306

ORDERING INFORMATION

Length Overall Inches	Max. Rope Size Inches	Display Package	Display Pkg. - 5 Cards Pcs. per Card	OEM Bulk Pkg. 50 Pcs.	Screw Size	Weight Ounces
4-1/2	3/8	1306 DP1 CHR	2	1306 001 CHR	10	4
6	1/2	1306 DP2 CHR	1	1306 002 CHR	1/4	8-1/2

FIG. 1406 - OPEN BASE CLEAT

**CHROME PLATED ZINC
BLACK PLASTIC BASE AND INSERT**

chromalex®



Fig. 1406

ORDERING INFORMATION

Length Overall Inches	Max. Rope Size Inches	Display Package	Display Pkg. - 5 Cards Pcs. per Card	OEM Bulk Pkg. 50 Pcs.	Screw Size	Weight Ounces
4-1/2	3/8	1406 DP1 CHR	2	1406 001 CHR	10	4
6	1/2	1406 DP2 CHR	1	1406 002 CHR	1/4	8-1/2
8	3/4	-----	---	1406 003 CHR	1/4	11

FIG. 1326 - OPEN BASE CLEAT

**CHROME PLATED ZINC
BLACK PLASTIC BASE**

chromalex®



Fig. 1326

ORDERING INFORMATION

Length Overall Inches	Dimensions Base Inches	Max. Rope Size Inches	Display Pkg. - 5 Cards 1 Pc. per Card	OEM Bulk Pkg. 50 Pcs.	Screw Size	Weight Ounces
5-3/4	3-5/8 x 7/8	1/2	1326 DP2 CHR	1326 002 CHR	1/4	9

FIG. 573 - OPEN BASE CLEAT

**CHROME PLATED BRONZE
BLACK PLASTIC BASE**

chromalex®



Fig. 573

ORDERING INFORMATION

Length Overall Inches	Dimensions Base Inches	Max. Rope Size Inches	Display Pkg. - 5 Cards 1 Pc. per Card	OEM Bulk Pkg. 25 Pcs.	Screw Size	Weight Ounces
6	3-5/8 x 7/8	1/2	573 DP6 CHR	573 006 CHR	1/4	9

DECK HARDWARE, CLEATS, CHOCKS, BITTS, BOW EYES, ROWLOCKS, WINDSHIELD & HATCH ADJUSTERS

CHOCKS



FIG. 1223 - SKENE BOW CHOCKS



FIG. 1223

CHROME PLATED ZINC

ORDERING INFORMATION

Max. Rope Size Inches	Length Overall Inches	Width Inches	Display Pkg. - 5 Cards 1 Pair per Card	OEM Bulk Pkg. 50 Pair	Screw Size	Weight per Pair Ounces
1/2	3-1/2	7/8	1223 DP CHR	1223 000 CHR	8	4



FIG. 119 - STRAIGHT CHOCK



FIG. 119

CHROME PLATED BRONZE

ORDERING INFORMATION

Maximum Rope Size Inches	Length Overall Inches	Width Inches	Display Pkg. - 5 Cards 1 Pc. per Card	OEM Bulk Pkg. 10 Pcs.	Screw Size	Weight Each Pounds
3/4	4	7/8	119 DP4 CHR	119 004 CHR	8	1/4
1	6	1-1/8	119 DP6 CHR	-----	12	3/4



FIG. 1230 - STRAIGHT CHOCKS



FIG. 1230

CHROME PLATED ZINC

ORDERING INFORMATION

Maximum Rope Size Inches	Length Overall Inches	Width Inches	Display Pkg. - 10 Cards 1 Pair per Card	OEM Bulk Pkg. 50 Pair	Screw Size	Weight per Pair Ounces
3/4	4	7/8	1230 DP CHR	1230 000 CHR	8	6

DECK HARDWARE, CLEATS, CHOCKS, BITTS, BOW EYES, ROWLOCKS, WINDSHIELD & HATCH ADJUSTERS

MOORING BITT, HAWSE HOLE PLATES & LIFTING EYES

FIG. 608 - MOORING BITT

CHROME PLATED BRONZE. HOLLOW

ORDERING INFORMATION

Dimensions Base Inches	Height Inches	Standard Pkg. 1 Pc.	Bolt Size	Weight Pounds
4-1/4 x 4-1/4	3-1/2	608 002 CHR	1/4	1-7/8
5 x 5	4-3/4	608 02A CHR	3/8	3-1/2
6 x 6	5	608 003 CHR	3/8	4-1/2

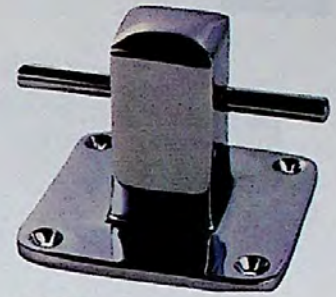

FIG. 608

FIG. 434 - LIFTING EYE AND CLEAT

**CHROME PLATED MANGANESE BRONZE
SAFE WORKING LOAD 4000 POUNDS**

ORDERING INFORMATION

For Rod Threaded Inches	I.D. Eye Inches	Length Overall Inches	Dimensions Base Inches	Display Pkg. - 5 Cards 1 Pc. per Card	Screw Size	Weight Ounces
5/8 x 11	1-1/16	5-1/16	3-1/2 x 2-1/2	434 DP CHR	10	18



FIG. 434

FIG. 429 - LIFTING EYE

**CHROME PLATED MANGANESE BRONZE. INTEGRAL FLANGE
SAFE WORKING LOAD 3000 POUNDS***

ORDERING INFORMATION

For Rod Threaded Inches	I.D. Eye Inches	O.D. Eye Inches	O.D. Base Inches	Standard Pkg. - 1 Pc.	Screw Size	Weight Ounces
5/8 x 11	1-1/2	2-1/4	2-1/4	429 000 CHR	8	19



FIG. 429

FIG. 752 - HAWSE HOLE PLATE

CHROME PLATED BRONZE

ORDERING INFORMATION

Dimensions Outside Inches	Dimensions Inside Inches	Length Spigot Inches	Std. Pkg. - 1 Pc. OEM Pkg. - 10 Pcs.	Screw Size	Weight Pounds
4-1/4 x 6	2-1/8 x 4-1/8	1-1/4	752 000 CHR	1/4	1-1/2



FIG. 752

***IMPORTANT NOTE: THE SAFE WORKING LOAD INFORMATION GIVEN FOR THE ITEMS ABOVE IS BASED ON A STRAIGHT AXIAL PULL. THIS INFORMATION WOULD NOT APPLY IN CASES WHERE INSTALLATION OR USE CREATES ANGULAR LOADING SINCE THESE VARIATIONS MAKE IT IMPRACTICABLE TO OFFER ACCURATE TEST DATA.**

DECK HARDWARE, CLEATS, CHOCKS, BITTS, BOW EYES, ROWLOCKS, WINDSHIELD & HATCH ADJUSTERS

DECK PIPES



FIG. 750 - ROPE AND CHAIN DECK PIPE

CHROME PLATED BRONZE

The Cover Has a Hook for Hanging Chain and a Stainless Steel Cable Retainer.



Fig. 750

ORDERING INFORMATION

Opening For Chain Size Inches	Dimensions Flange Inches	Height Overall Inches	Display Pkg. - 5 Cards 1 Pc. per Card	Screw Size	Weight Pounds
3/8	5-1/4 x 4	1-3/8	750 DP CHR	8	2

Spare Cover with Hook and Cable, Cat. No. 750 DP 99A



FIG. 1057 - ROPE DECK PIPE

U.V. STABILIZED, FIBER REINFORCED HIGH IMPACT BLACK OR WHITE PLASTIC

Hinged, Snap-Down Cover



Fig. 1057 WHT



Fig. 1057 BLK

ORDERING INFORMATION

Color	Maximum Rope Size Inches	O.D. Flange Inches	Display Pkg. - 5 Cards 1 Pc. per Card	OEM Bulk Pkg. 25 Pcs.	Screw Size	Weight Ounces
Black	7/8	3-3/4	1057 DP BLK	1057 000 BLK	8	3-1/4
White	7/8	3-3/4	1057 DP WHT	1057 000 WHT	8	3-1/4



FIG. 741 - ROPE DECK PIPE

CHROME PLATED BRONZE

ORDERING INFORMATION



Fig. 741

Maximum Rope Size Inches	O.D. Flange Inches	Display Pkg. - 5 Cards 1 Pc. per Card	OEM Bulk Pkg. 10 Pcs.	Screw Size	Weight Pounds
5/8	3	741 DP0 CHR	741 000 CHR	8	3/4

Spare No. 0 Cap with Chain, Cat. No. 741 DP0 99A.



FIG. 757 - ROPE DECK PIPE

CHROME PLATED ZINC

ORDERING INFORMATION



Fig. 757

Maximum Rope Size Inches	O.D. Flange Inches	Display Pkg. - 5 Cards 1 Pc. per Card	OEM Bulk Pkg. 10 Pcs.	Screw Size	Weight Pounds
1	3-3/8	757 DP CHR	757 000 CHR	8	1/2

ANCHOR CHOCKS & RIGGING TUBE

CHROME PLATED BRONZE, POLISHED OR BURNISHED



Size No. 1 Fits	
Fortress Models FX7-FX16	Danforth® Models H [®] 500 T [™] 570 H [®] 960 T [™] 1200 H [®] 1500 T [™] 1800 S [®] 160 T [™] 2500 S [®] 300 T [™] 3000
U.S. Anchor Mfg., INC. Models 2-1/2, 4, 8, 13	S [®] 600 D [™] 375 S [®] 920 D [™] 750 S [®] 1300 D [™] 1150 VSB [™] 160 D [™] 1650 VSB [™] 13000 VSB [™] 1900
Size No. 2 Fits	
Fortress Models FX23-FX55	Danforth® Models H [®] 1800 T [™] 4000 H [®] 3100 T [™] 6000 H [®] 3600 T [™] 7000 D [™] 2000 D [™] 2500
U.S. Anchor Mfg., INC. Models 18 & 22	S [®] 1600 S [®] 2000 S [®] 3000 VSB [™] 2500 VSB [™] 3600



Fig. 903

ORDERING INFORMATION

Polished Chrome Plated Bronze Display Pkg. - 5 Cards 1 Set per Card	Burnished Chrome Plated Bronze Display Pkg. - 5 Cards 1 Set per Card	Screw Size	Weight Per Set Pounds
903 DP1 CHR	903 DP1 BUR	10	2
903 DP2 CHR	903 DP2 BUR	10	2-1/4

SPARE PARTS ORDERING INFORMATION

To Specify Size Replace the Sixth Digit With the Size Number (i.e. 903 001 99A or 903 B01 99A).

Spare Polished Chrome Shank Support, Cat. No. 903 000 99A.
Spare Pair, Polished Chrome Fluke Supports, Cat. No. 903 000 99B.
Spare Polished Chrome Crown Support, Cat. No. 903 000 99C.
Spare Knob, Cat. No. 1144 A00 BLK.

Spare Burnished Chrome Shank Support, Cat. No. 903 B00 99A.
Spare Pair, Burnished Chrome Fluke Supports, Cat. No. 903 B00 99B.
Spare Burnished Chrome Crown Support, Cat. No. 903 B00 99C.

FIG. 357 - RIGGING TUBE

CHROME PLATED BRASS AND BRONZE

For use with 2 Inch I.D. Hose to Pass Wiring Harnesses and Control Cables Through Transoms and Motorwell Bulkheads.

Mounts in 2-1/8 Inch Diameter Hole.

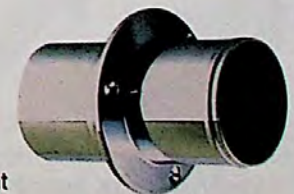

Fig. 357

ORDERING INFORMATION

O.D. Tube Inches	Length Overall Inches	O.D. Flange Inches	Display Pkg. - 5 Pcs. 1 Pc. per Card	Standard Pkg. - 1 Pcs. OEM Bulk Pkg. - 25 Pcs.	Screw Size	Weight Ounces
2	4-1/8	3-1/8	357 DP1 CHR	357 001 CHR	8	12

Bow & Transom Eyes

NOTE: THE BOW EYES AND TRANSOM EYES ILLUSTRATED ON THIS PAGE ARE NOT DESIGNED TO BEAR THE WEIGHT OF THE VESSEL AND THEREFORE SHOULD NOT BE USED FOR LIFTING.



FIG. 237 - BOW EYE

**NON-MAGNETIC 300 SERIES STAINLESS STEEL SHANK
STAINLESS STEEL NUTS & WASHERS**

ORDERING INFORMATION



Fig. 237

Length Shank Inches	O.D. Shank Inches	I.D. Eye Inches	Length Thread Inches	Display Pkg. - 10 Cards 1 Pc. per Card	Weight Ounces	Safe Working Load Pounds
3	5/16	1	3	237 DP1 STS	4	1800
6	5/16	1	6	237 DP2 STS	5-1/2	1800
3	3/8	1-1/8	3	*237 DP3 STS	5	3000
3-1/4	1/2	1-1/2	3-1/4	*237 DP4 STS	12	4600

* Display Pkg., 5 cards, 1 Pc. per card



FIG. 1235 - BOW EYE

**CHROME PLATED ZINC EYE
ZINC PLATED STEEL "U" BOLT, NUTS & WASHERS**

SAFE WORKING LOAD 2000 POUNDS*

ORDERING INFORMATION



Fig. 1235

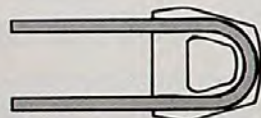

Length Shank Inches	O.D. Shank Inches	I.D. Eye Inches	Length Thread Inches	Display Pkg. - 10 Cards 1 Pc. per Card	Weight Ounces
3	5/16	1	2-3/4	1235 DP CHR	11



FIG. 236 - TRANSOM EYE

**NON-MAGNETIC 300 SERIES STAINLESS STEEL SHANK
STAINLESS STEEL FINISHING PLATE, NUTS & WASHERS**

For Use as Towing or Lashing Eye.

ORDERING INFORMATION



Fig. 236

Length Shank Inches	O.D. Shank Inches	I.D. Eye Inches	Dimensions Plate Inches	Display Pkg. - 5 Cards 1 Pc. per Card	Weight Ounces	Safe Working Load Pounds
3	5/16	1	3 x 1-3/4	*236 DP1 STS	6	1800
3	5/16	1-1/8	3 x 1-3/4	236 DP3 STS	10	3000
3-1/4	1/2	1-1/2	4 x 1-3/4	236 DP4 STS	14-1/2	4600

* Display Pkg., 10 cards, 1 Pc. per card

***IMPORTANT NOTE: THE SAFE WORKING LOAD INFORMATION GIVEN FOR THE ITEMS ABOVE IS BASED ON A STRAIGHT AXIAL PULL. THIS INFORMATION WOULD NOT APPLY IN CASES WHERE INSTALLATION OR USE CREATES ANGULAR LOADING SINCE THESE VARIATIONS MAKE IT IMPRACTICABLE TO OFFER ACCURATE TEST DATA.**

STEP PLATES & STEPS

FIG. 1043 - STEP PLATES

CHROME PLATED BRONZE FRAMES. SOFT BLACK PLASTIC PADS

FIG. 1325 - STEP PLATES

CHROME PLATED ZINC FRAMES. SOFT BLACK PLASTIC PADS

ORDERING INFORMATION

Dimensions Inches	Display Pkg. - 5 Cards 1 Pcs. per Card	OEM Bulk Pkg. 50 Pcs.	Screw Size	Weight Ounces
8-3/4 x 3-1/4	1043 DP1 CHR	-----	6	8
11-1/2 x 5-3/4	1043 DP2 CHR	-----	8	12
8-3/8 x 2-1/4	*1325 DP0 CHR	1325 000 CHR	8	5
8-3/4 x 3-1/4	*1325 DP1 CHR	1325 001 CHR	8	8

* Display Package 2 Pcs. per card.

Spare Pads for Size No. 0 (2 per bag), Cat. No. 1050 DP0 BLK.

Spare Pads for Size No. 1 (2 per bag), Cat. No. 1050 DP1 BLK.

Spare Pads for Size No. 2 (2 per bag), Cat. No. 1050 DP2 BLK.



Fig. 1043



Fig. 1325

FIG. 1015 - STEP PLATE

**CHROME PLATED BRASS FRAME
SOFT BLACK PLASTIC TREAD INSERT**

ORDERING INFORMATION

Dimensions Inches	Display Pkg. - 5 Cards 2 Pcs. per Card	O.E.M. Bulk Pkg. 50 Pcs.	Screw Size	Weight Ounces
7-1/4 x 1-1/2	1015 DP CHR	1015 000 CHR	8	2



Fig. 1015

FIG. 351 & 501 - FIXED STEPS

CHROME PLATED BRONZE

ORDERING INFORMATION

Dimensions Step Inches	Dimensions Bracket Inches	Display Pkg. - 5 Cards 1 Pc. per Card	Standard Package - 1 Pc.	Bolt Size	Weight Pounds
6 x 4-1/4	6 x 2	351 DP CHR	-----	5/16 R.H.	1-1/8
11 x 4-1/2	11 x 2	-----	501 000 CHR	5/16 R.H.	2-7/8



Fig. 351



Fig. 501

FIG. 344 - FOLDING STEPS

CHROME PLATED BRONZE

Stainless Steel Spring Holds Steps
in Open or Closed Position.

ORDERING INFORMATION

Dimensions Step Inches	Dimensions Bracket Inches	Projection Folded Inches	Display Pkg. - 5 Cards 1 Pc. per Card	Bolt Size	Weight Pounds
4-1/8 x 2-1/4	4-1/4 x 1-3/4	1-3/8	344 DP CHR	5/16 R.H.	1-1/2



Fig. 344



FLAG POLE SOCKETS & FLAG STAFF



FIG. 218 & 219 - FLUSH FLAG POLE SOCKETS

CHROME PLATED BRONZE

FIG. 218 - BOW SOCKET

FIG. 219 - STERN SOCKET

ORDERING INFORMATION



FIG. 218
Bow



FIG. 219
STERN

	I.D. Socket Inches	O.D. Flange Inches	Depth Socket Inches	Fig. 218 Display Pkg. - 5 Cards 1 Pc. per Card	Fig. 219 Display Pkg. - 5 Cards 1 Pc. per Card	Screw Size	Weight Ounces
	3/4	2	1-1/2	218 DP1 CHR	219 DP1 CHR	8	4-1/2
	1	2-3/8	1-3/4	218 DP2 CHR	219 DP2 CHR	8	5
	1-1/4	2-5/8	2	218 DP3 CHR	219 DP3 CHR	8	9



FIG. 220 & 221 - UPRIGHT FLAG POLE SOCKETS

CHROME PLATED BRONZE

FIG. 220 - BOW SOCKET

FIG. 221 - STERN SOCKET

ORDERING INFORMATION



FIG. 221
STERN



FIG. 220
Bow

	I.D. Socket Inches	O.D. Base Inches	Height Overall Inches	Fig. 220 Display Pkg. - 5 Cards 1 Pc. per Card	Fig. 221 Display Pkg. - 5 Cards 1 Pc. per Card	Screw Size	Weight Ounces
	3/4	2-1/8	1-3/4	220 DP1 CHR	221 DP1 CHR	8	5-1/4
	1	2-1/2	2	220 DP2 CHR	221 DP2 CHR	8	6-3/4
	1-1/4	2-3/4	2-1/8	220 DP3 CHR	221 DP3 CHR	8	10-3/4



FIG. 1302 - CLAMP-ON FLAG POLE SOCKET

**CHROME PLATED ZINC
BLACK PLASTIC KNOB**

For Rail Sizes 3/4 to 1 Inch.

ORDERING INFORMATION

I.D. Socket Inches	Dimensions Bracket Inches	Display Pkg. - 5 Cards 1 Pc. per Card	Weight Ounces
3/4	2 x 1-3/4	1302 DP CHR	11

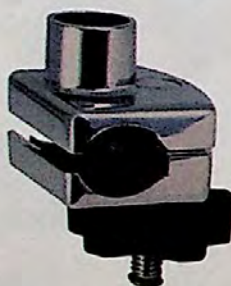

FIG. 1302



FIG. 495 - FLAG STAFF

**CHROME PLATED ZINC BASE AND TOP
ANODIZED ALUMINUM TUBE**

Sizes 2 and 3 For Use With Fig. 1302 Clamp-On Socket Only.

ORDERING INFORMATION

O.D. Base Inches	Length Overall Inches	Display Pkg. - 5 Bags 1 Pc. per Bag	Weight Ounces
1/2	14	495 DP1 CHR	3
3/4	14	495 DP2 CHR	4
3/4	18	495 DP3 CHR	5

FIG. 495

HANDLES

FIG. 1336 - HANDLES

CHROME PLATED ZINC. BLACK PLASTIC BASE

chromalex®

ORDERING INFORMATION

Length Overall Inches	Length Inside Inches	Height Inside Inches	Display Pkg. - 5 Cards 2 Pcs. per Card	OEM Bulk Pkg. 50 Pcs.	Screw Size	Weight Ounces
6-1/4	3-1/2	1	1336 DP CHR	1336 000 CHR	1/4	10



FIG. 1336

FIG. 1346 - HANDLES

CHROME PLATED ZINC. BLACK PLASTIC BASE

chromalex®

ORDERING INFORMATION

Length Overall Inches	Length Inside Inches	Height Inside Inches	Std. Pkg. - 10 Pcs. OEM Bulk Pkg. - 50 Pcs.	Stud Size	Weight Ounces
6-1/4	3-1/2	1	1346 000 CHR	1/4 - 20 x 1-1/2	11



FIG. 1346

FIG. 1222 - HANDLE

CHROME PLATED ZINC

ORDERING INFORMATION

Length Overall Inches	Length Inside Inches	Height Inside Inches	Display Pkg. - 5 Cards 2 pcs. per Card	OEM Bulk Pkg. 100 Pcs.	Screw Size	Weight Ounces
5-3/4	3-5/8	1-1/4	1222 DP CHR	1222 000 CHR	8	3-1/2



FIG. 1222

FIG. 1231 - HANDLE

CHROME PLATED ZINC

ORDERING INFORMATION

Length Overall Inches	Length Inside Inches	Height Inside Inches	Display Pkg. - 5 Cards 2 pcs. per Card	OEM Bulk Pkg. 50 Pcs.	Screw Size	Weight Ounces
6	3-1/2	1-5/16	1231 DP CHR	1231 000 CHR	1/4	7-1/4



FIG. 1231

FIG. 775 - HANDLE

CHROME PLATED BRONZE

ORDERING INFORMATION

Length Overall Inches	Length Inside Inches	Height Inside Inches	Display Pkg. - 5 Cards 2 pcs. per Card	OEM Bulk Pkg. 50 Pcs.	Screw Size	Weight Ounces
4-1/4	2-1/2	7/8	775 DP1 CHR	775 001 CHR	6	2
5-3/4	3-5/8	1-3/8	775 DP2 CHR	775 002 CHR	8	4



FIG. 775

DECK HARDWARE, CLEATS, CHOCKS, BITTS, BOW EYES, ROWLOCKS, WINDSHIELD & HATCH ADJUSTERS

GRAB RAIL & POSTS



FIG. 491 - GRAB RAIL

**CHROME PLATED ZINC END POSTS
POLISHED 18-8 STAINLESS STEEL TUBE**



Fig. 491

ORDERING INFORMATION

Length Overall Inches	Length Inside Inches	Height Inside Inches	Display Pkg. - 5 Cards 1 pc. per Card	Screw Size	Weight Pounds
9-1/2	7	3/4	491 DP1 CHR	6	3/4
15-5/8	13	3/4	491 DP2 CHR	6	1



**Fig. 1297
END POST**



**Fig. 1298
CENTER POST**

FIG. 1297 & 1298 - GRAB RAIL POSTS

**CHROME PLATED ZINC
FIG. 1297 - END POST
FIG. 1298 - CENTER POST**

Hollow, For 3/4 Inch O.D. Tubing

ORDERING INFORMATION

Height Overall Inches	O.D. Base Inches	Fig. 1297 Standard Pkg. - 4 Pcs.	Fig. 1298 Standard Pkg. - 2 Pcs.	Screw Size	Weight Ounces
1-3/4	1-5/8	1297 000 CHR	1298 000 CHR	6	2-3/4



**Fig. 380
END POST**



**Fig. 380A
CENTER POST**

FIG. 380 & 380A - GRAB RAIL POSTS

**CHROME PLATED BRONZE
FIG. 380 - END POST
FIG. 380A - CENTER POST**

Hollow, For 1 Inch O.D. Tubing

ORDERING INFORMATION

Height Overall Inches	O.D. Base Inches	Fig. 380 Standard Pkg. - 1 Pc.	Fig. 380A Standard Pkg. - 1 Pc.	Screw Size	Weight Ounces
3-3/8	2-1/2	380 000 CHR	380 A00 CHR	8	10

FIG. 413 - GRAB RAIL END POST

CHROME PLATED BRONZE

Hollow, For 1 Inch O.D. Tubing
with .035 Inch Wall Thickness



**Fig. 413
END POST**

ORDERING INFORMATION

Height Overall Inches	Dimensions Base Inches	Standard Pkg. - 1 Pc.	Screw Size	Weight Ounces
2-1/4	3 x 2	413 000 CHR	8	10

AXE BRACKETS, WOOD GUARD RAIL FITTINGS & RING BUOY HOLDER

FIG. 325 - AXE BRACKETS



STAINLESS STEEL

ORDERING INFORMATION

For Blade Width Inches	Standard Pkg. - 10 sets	Socket Screw Size	Bracket Screw Size	Weight per Set Ounces
6	325 000 STS	10 R.H.	6	4-1/2



FIG. 325

FIG. 180 & 185 - FITTINGS FOR WOOD GUARD RAILS

CHROME PLATED BRONZE

HINGE - FIG. 180
LATCH - FIG. 185

ORDERING INFORMATION

For Rail Dimensions Inches	Length Overall Inches	Fig. 180 Standard Pkg. - 1 Pc.	Fig. 185 Standard Pkg. - 1 Pc.	Screw Size	Weight Pounds
2-3/8 x 1-3/8	5	180 001 CHR	185 001 CHR	8	3/4

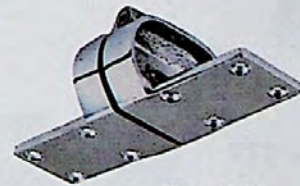

FIG. 180



FIG. 185

FIG. 1017 - RING BUOY HOLDER



BRASS
PLAIN OR CHROME PLATED

ORDERING INFORMATION

Width Mounting Plate Inches	Height Overall Inches	Chrome Plated Brass Display Pkg. - 5 Cards 1 Pc. per Card	Plain Brass Standard Pkg. - 5 Pcs.	Screw Size	Weight Pounds
3	4-1/2	1017 DP CHR	1017 000 PLB	8	1/2



FIG. 1017

DECK HARDWARE, CLEATS, CHOCKS, BITTS, BOW EYES, ROWLOCKS, WINDSHIELD & HATCH ADJUSTERS



Fig. 492

Fig. 492 - BOAT HOOK HOLDERS

STAINLESS STEEL

ORDERING INFORMATION

Maximum Pole O.D. Inches	Length Inches	Width Inches	Display Pkg. - 10 Cards 1 Pair per Card	OEM Bulk Pkg. 50 Pair	Screw Size	Weight Per Pair Ounces
1-1/2	3-1/2	1	492 DP STS	492 000 STS	6	1-1/2



Fig. 477

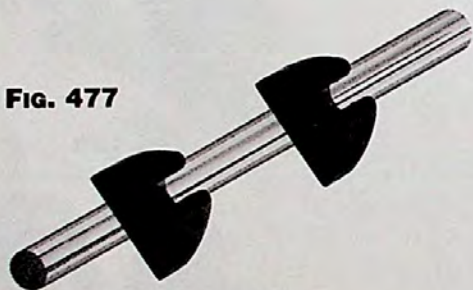

Fig. 477 - POLE STORAGE CLIPS

**SOFT BLACK PLASTIC
FITS 3/4 INCH DIAMETER TUBING
U.V. STABILIZED**

ORDERING INFORMATION

For Pole O.D. Inches	Dimensions Inches	Display Pkg. - 10 Cards 1 Pair per Card	OEM Bulk Pkg. 50 Pair	Screw Size	Weight per Pair Ounces
3/4	3/4 x 2-1/4 x 1-5/8	477 DP BLK	477 000 BLK	10 P.H.	3



Fig. 502

Fig. 502 - SPRING CLAMPS

STAINLESS STEEL

ORDERING INFORMATION

Minimum I.D. Inches	Maximum I.D. Inches	Projection Inches	Width Clamp Inches	Display Pkg. - 10 Cards 1 Pair per Card	Screw Size	Weight per Pair Ounces
5/8	1-1/4	1-1/2	1/2	502 DP1 STS	6 R.H.	2
1	1-3/4	2-1/4	5/8	502 DP2 STS	6 R.H.	2-1/2



ROPE PULLEYS

FIG. 1255 - ROPE PULLEY

**CHROME PLATED ZINC
WHITE PLASTIC SHEAVE**

Coaming Type
Maximum Rope Size 1/4 Inch.

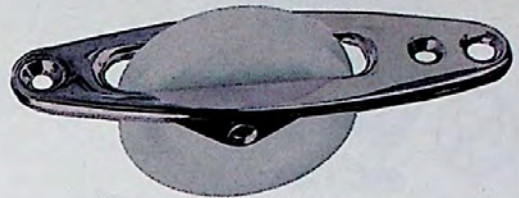

FIG. 1255

ORDERING INFORMATION

O.D. Sheave Inches	Dimensions Plate Inches	Display Pkg. - 10 Cards 1 Pc. per Card	Screw Size	Weight Ounces
2-5/16	4-7/8 x 1-1/4	1255 DP CHR	6	1/2



FIG. 565 - ROPE PULLEY

**STAINLESS STEEL
WHITE PLASTIC SHEAVE**

Swivel Type with Strap
Maximum Rope Size 1/4 Inch.

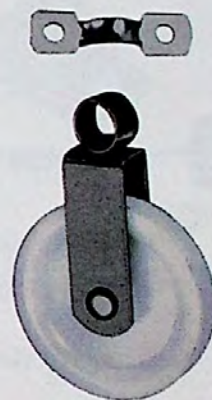

FIG. 565

ORDERING INFORMATION

O.D. Sheave Inches	Length Overall Inches	Length Strap Inches	Display Pkg. - 5 Cards 2 Pcs. per Card	Screw Size	Weight Ounces
2-5/16	3-3/4	1-5/8	565 DP	10 R.H.	2



FIG. 634 - ROPE PULLEY

**STAINLESS STEEL
WHITE PLASTIC SHEAVE**

Swivel Snap Hook Type
Maximum Rope Size 1/4 Inch.

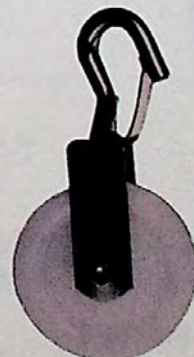

FIG. 634

ORDERING INFORMATION

O.D. Sheave Inches	Length Overall Inches	Opening Snap Throat Inches	Display Pkg. - 5 Cards 2 Pcs. per Card	Weight Ounces
2-5/16	4-5/8	1/2	634 DP	2-1/2



ROPE CLAMP, ROPE GUIDES & WINDSHIELD WIPER



Fig. 1226

FIG. 1226 - ROPE CLAMP

CHROME PLATED ZINC

For 1/8 or 3/16 Inch Rope.

ORDERING INFORMATION



Length Overall Inches	Width Inches	Display Pkg. - 25 Cards 2 Pcs. per Card	OEM Bulk Pkg. 100 Pcs.	Weight Ounces
1-1/4	11/16	1226 DP CHR	1226 000 CHR	1



Fig. 1256



Fig. 1261

FIG. 1256 & 1261 - ROPE GUIDES

CHROME PLATED ZINC

ORDERING INFORMATION



I.D. Hole Inches	Dimensions Base Inches	Display Pkg. - 25 Cards 2 Pcs. per Card	OEM Bulk Pkg. 100 Pcs.	Screw Size	Weight Ounces
5/16	1-1/4 x 3/4	1256 DP CHR	1256 000 CHR	6	1/2
5/16	1-1/4 x 3/4	1261 DP CHR	1261 000 CHR	6	1/2



Fig. 533

FIG. 533 - HAND WINDSHIELD WIPER

CHROME PLATED ZINC

400 SERIES STAINLESS STEEL ARM AND BLADE HOLDER

For Straight and Curved Windshields, the Arm is Extendable from 6-3/4 to 10-1/2 Inches (Length Overall is 8 to 11-1/2 Inches), and the Spring Tension is Adjustable.

ORDERING INFORMATION

O.D. Shaft Inches	Maximum Thickness of Panel Inches	Length Handle Inches	Length Blade Inches	Display Pkg. - 5 Pcs. 1 Pc. per Card	Weight Ounces
3/8	1-1/8	2-3/8	12	533 DP STS	8
Spare Arm, Cat. No. 533 000 99A.				Spare Curved Blade, Cat. No. 533 000 99B.	
Spare Handle, Cat. No. 533 000 99D.					

ROPE GUIDE, SPRING & TIGHTENERS

FIG. 1243 - ROPE GUIDE

**CHROME PLATED ZINC
WITH BLACK PLASTIC SHEAVE**

ORDERING INFORMATION

Maximum Rope Size Inches	O.D. Sheave Inches	Dimensions Base Inches	Display Pkg. - 10 Cards 1 Pc. per Card	Screw Size	Weight Ounces
1/4	7/8	2 x 3/4	1243 DP CHR	8	1-3/4



FIG. 1243



FIG. 759 - DOCK LINE SPRING

GALVANIZED SPRING STEEL

ORDERING INFORMATION

For Rope Size Inches	Length Overall Inches	O.D. Inches	Compression Inches	Standard Package - 5 Pcs.	Weight Pounds
1/2	10	1-1/2	4-1/2	759 001 ZNC	7/8



FIG. 759

FIG. 732 - ROPE TIGHTENER

**ZINC PLATED SPRING STEEL
OR
STAINLESS STEEL**

ORDERING INFORMATION

Finish	Length Normal Inches	Length Compressed Inches	O.D. Inches	Display Pkg. - 5 Cards 2 Pcs. per Card	Weight Ounces
Zinc	4	5	1	732 DP CAD	3-1/2
Stainless	4	5	1	732 DP STS	2-1/4



FIG. 732 STAINLESS



FIG. 732 ZINC



FIG. 754 - ROPE TIGHTENER

ZINC PLATED SPRING STEEL

ORDERING INFORMATION

Length Normal Inches	Length Compressed Inches	O.D. Inches	Display Pkg. - 10 Cards 2 Pcs. per Card	Weight Ounces
4-3/4	6-1/2	7/8	754 DP CAD	2-3/4



FIG. 754



DECK HARDWARE, CLEATS, CHOCKS, BITTS, BOW EYES, ROWLOCKS, WINDSHIELD & HATCH ADJUSTERS

EYE STRAPS



FIG. 881 - EYE STRAP



Fig. 881

CHROME PLATED FORGED BRONZE

ORDERING INFORMATION

Length Overall Inches	I.D. Eye Inches	O.D. Stock at Eye Inches	Display Pkg. - 25 Cards 2 Pcs. per Card	OEM Bulk Pkg. 50 Pcs.	Screw Size	Weight Ounces
1-7/8	1/4	1/4	881 DP0 CHR	881 000 CHR	8	1/2
2-1/4	5/16	9/32	881 DP1 CHR	881 001 CHR	10	3/4



FIG. 1242 - EYE STRAP



Fig. 1242

CHROME PLATED ZINC

ORDERING INFORMATION

Length Overall Inches	I.D. Eye Inches	Display Pkg. - 10 Cards 5 Pcs. per Card	OEM Bulk Pkg. 100 Pcs.	Screw Size	Weight Ounces
1-7/8	5/16	1242 DP CHR	1242 000 CHR	8	1/4



FIG. 562 - EYE STRAP



Fig. 562

300 SERIES STAINLESS STEEL

ORDERING INFORMATION

Length Overall Inches	I.D. Eye Inches	Display Pkg. - 10 Cards 5 Pcs. per Card	OEM Bulk Pkg. 100 Pcs.	Screw Size	Weight Ounces
1-5/8	1/4	562 DP STS	562 000 STS	10 R.H.	1/8



DECK HARDWARE, CLEATS, CHOCKS, BITTS, BOW EYES, ROWLOCKS, WINDSHIELD & HATCH ADJUSTERS

FENDER LOCK & HOOKS

FIG. 1299 - FENDER LOCK



CHROME PLATED ZINC

The Eye is to be Permanently Attached to the Fender Line.



Fig. 1299



ORDERING INFORMATION

I.D. Eye Inches	O.D. Flange Inches	Display Pkg. - 10 Cards 2 Pcs. per Card	Screw Size	Weight Ounces
3/8	1-1/2	1299 DP CHR	8	1

Spare Eye, Cat. No. 1299 000 99A.

FIG. 1246 - FENDER HOOK



CHROME PLATED ZINC



Fig. 1246



ORDERING INFORMATION

Maximum Rope Size Inches	Dimensions Plate Inches	Display Pkg. - 10 Cards 2 Pcs. per Card	Screw Size	Weight Ounces
3/8	1-3/4 x 1-1/4	1246 DP CHR	6	1-1/4

FIG. 1309 - SNAP TYPE FENDER HOOK



CHROME PLATED ZINC



Fig. 1309



ORDERING INFORMATION

Maximum Rope Size Inches	Dimensions Plate Inches	Display Pkg. - 10 Cards 2 Pcs. per Card	OEM Bulk Pkg. 100 Pcs.	Screw Size	Weight Ounces
1/4	1-9/16 x 1-3/8	1309 DP CHR	1309 000 CHR	6	1-1/2

FIG. 614 - FAST EYE SNAP HOOK

NON-MAGNETIC 316 SERIES STAINLESS STEEL

INTERLOCKING TONGUE



Fig. 614

ORDERING INFORMATION

I.D. Eye Inches	Length Overall Inches	O.D. Stock Inches	Display Pkg. - 10 Cards 1 Pc. per Card	OEM Bulk Pkg. 10 Pcs.	Weight Ounces	Safe Working Load Pounds
3/8	3	5/16	614 DP STS	614 000 STS	2-1/2	350



DECK HARDWARE, CLEATS, CHOCKS, BITTS, BOW EYES, ROWLOCKS, WINDSHIELD & HATCH ADJUSTERS

EYE SNAPS

NOTE: THE SNAPS ILLUSTRATED BELOW SHOULD NOT BE USED FOR LIFTING, WINCHING, TOWING, MOORING OR LIKE APPLICATIONS.



FIG. 612 - FAST EYE BOAT SNAP

PLAIN BRONZE



FIG. 612

ORDERING INFORMATION

I.D. Eye Inches	Length Overall Inches	Display Pkg. - 10 Cards 1 Pc. per Card	Weight Ounces
3/8	2-1/16	612 DP0 PLB	1
5/8	2-7/8	612 DP1 PLB	1-1/2
3/4	3	612 DP2 PLB	2
3/4	3-7/8	612 DP3 PLB	4



FIG. 613 - SWIVEL EYE BOAT SNAP

PLAIN BRONZE



FIG. 613

ORDERING INFORMATION

I.D. Eye Inches	Length Overall Inches	Display Pkg. - 10 Cards 1 Pc. per Card	Weight Ounces
9/16	3-1/4	613 DP1 PLB	2
11/16	3-5/8	613 DP2 PLB	3
3/4	4-5/8	613 DP3 PLB	4



FIG. 659 - SWIVEL EYE SNAP

PLAIN BRONZE



FIG. 659

ORDERING INFORMATION

I.D. Eye Inches	I.D. Hook Inches	Length Overall Inches	Display Pkg. - 10 Cards 1 Pc. per Card	Weight Ounces
3/4	7/16	3-1/2	659 DP PLB	2-1/2



FIG. 1289 - SWIVEL EYE SNAP

CHROME PLATED ZINC

INTERLOCKING TONGUE



FIG. 1289

ORDERING INFORMATION

I.D. Eye Inches	Length Overall Inches	Display Pkg. - 10 Cards 1 Pc. per Card	Weight Ounces
5/8	3	1289 DP CHR	2-1/2



BABY EYE SNAPS

NOTE: THE SNAPS ILLUSTRATED BELOW SHOULD NOT BE USED FOR LIFTING, WINCHING, TOWING, MOORING OR LIKE APPLICATIONS.

FIG. 1041 - SWIVEL BABY EYE SNAP



PLAIN BRONZE

ORDERING INFORMATION

Dimensions Eye Inches	Length Overall Inches	Display Pkg. - 25 Cards 2 Pcs. per Card	Weight Ounces
5/8 x 5/16	2-1/8	1041 DP PLB	1/2



FIG. 1041



FIG. 1042 - SWIVEL BABY EYE SNAP



PLAIN BRONZE

ORDERING INFORMATION

I.D. Eye Inches	Length Overall Inches	Display Pkg. - 25 Cards 2 Pcs. per Card	Weight Ounces
3/8	2-1/8	1042 DP PLB	1/2



FIG. 1042



FIG. 842 - FAST BABY EYE SNAP



PLAIN BRONZE

ORDERING INFORMATION

I.D. Eye Inches	Length Overall Inches	Display Pkg. - 25 Cards 2 Pcs. per Card	Weight Ounces
3/8	1-7/8	842 DP PLB	1/2



FIG. 842



DECK HARDWARE, CLEATS, CHOCKS, BITTS, BOW EYES, ROWLOCKS, WINDSHIELD & HATCH ADJUSTERS

ROWLOCK HORNS



FIG. 1227 - NORTH RIVER TYPE ROWLOCK HORNS



FIG. 1227

**ZINC
PLAIN OR CHROME PLATED**

ORDERING INFORMATION

Finish	O.D. Shank Inches	Length Shank Inches	Between Horns Inches	Display Pkg. - 10 Cards 1 Pair per Card	Weight per Pair Ounces
Plain	1/2	1-3/4	1-3/4	1227 DP ZNC	10
Chrome	1/2	1-3/4	1-3/4	1227 DP CHR	10



FIG. 1267 - ROUND TYPE ROWLOCK HORNS



FIG. 1267

**ZINC
PLAIN OR CHROME PLATED**

ORDERING INFORMATION

Finish	O.D. Shank Inches	Length Shank Inches	I.D. Horn Inches	Display Pkg. - 10 Cards 1 Pair per Card	Weight per Pair Ounces
Plain	1/2	1-3/4	2	1267 DP ZNC	9-1/2
Chrome	1/2	1-3/4	2	1267 DP CHR	9-1/2



FIG. 1262 - RIBBED TYPE ROWLOCK HORNS



FIG. 1262

**ZINC
PLAIN OR CHROME PLATED**

ORDERING INFORMATION

Finish	O.D. Shank Inches	Length Shank Inches	Between Horns Inches	Display Pkg. - 10 Cards 1 Pair per Card	Weight per Pair Ounces
Plain	1/2	1-3/4	1-3/4	1262 DP ZNC	8
Chrome	1/2	1-3/4	1-3/4	1262 DP CHR	8

ROWLOCK SOCKETS, OAR LEATHERS & BUTTONS

FIG. 1185 - TOP MOUNT ROWLOCK SOCKETS



**ZINC
PLAIN OR CHROME PLATED
BLACK PLASTIC BEARINGS**

ORDERING INFORMATION

Finish	Length Inches	Width Inches	Depth Inches	Display Pkg. - 10 Cards 1 Pair per Card	OEM Bulk Pkg. 50 Pair	Weight per Pair Ounces
Plain	2-7/8	1-1/8	1-1/8	1185 DP ZNC	1185 000 ZNC	5
Chrome	2-7/8	1-1/8	1-1/8	1185 DP CHR	1185 000 CHR	5



FIG. 1185

Screw Size #10.
Spare Plastic Bearing, Cat. No. 1155 000 BLK.

FIG. 1186 - EDGE MOUNT ROWLOCK SOCKETS



**ZINC
PLAIN OR CHROME PLATED
BLACK PLASTIC BEARINGS**

ORDERING INFORMATION

Finish	Length Inches	Width Inches	Depth Inches	Display Pkg. - 10 Cards 1 Pair per Card	Weight per Pair Ounces
Plain	4	7/8	1-1/8	1186 DP ZNC	9
Chrome	4	7/8	1-1/8	1186 DP CHR	9



FIG. 1186

Screw Size #10.
Spare Plastic Bearing, Cat. No. 1155 000 BLK.

FIG. 1187 - SIDE MOUNT ROWLOCK SOCKETS



**ZINC
PLAIN OR CHROME PLATED
BLACK PLASTIC BEARINGS**

ORDERING INFORMATION

Finish	Length Inches	Depth Inches	Display Pkg. - 10 Cards 1 Pair per Card	Weight per Pair Ounces
Plain	4	1-1/4	1187 DP ZNC	6
Chrome	4	1-1/4	1187 DP CHR	6



FIG. 1187

Screw Size #10.
Spare Plastic Bearing, Cat. No. 1155 000 BLK.

FIG. 233 - OAR LEATHERS & BUTTONS

LEATHER

ORDERING INFORMATION

Dimensions Leather Inches	Dimensions Button Inches	Standard Pkg. - 5 Pair	Weight per Pair Ounces
7 x 6-1/2	1/2 x 13	233 001	10



FIG. 233

Note: Pair Consists of 2 Leathers and 2 Buttons.



DECK HARDWARE, CLEATS, CHOCKS, BITTS, BOW EYES, ROWLOCKS, WINDSHIELD & HATCH ADJUSTERS

ROWLOCK HORNS



Fig. 830

FIG. 830 - NORTH RIVER TYPE ROWLOCK HORNS

PLAIN MANGANESE BRONZE

ORDERING INFORMATION

O.D. Shank Inches	Length Shank Inches	Between Horns Inches	Display Pkg. - 5 Cards 1 Pair per Card	Weight per Pair Ounces
1/2	2-1/8	2-1/8	830 DP PLB	13



Fig. 829

FIG. 829 - ROUND TYPE ROWLOCK HORNS

PLAIN MANGANESE BRONZE

ORDERING INFORMATION

O.D. Shank Inches	Length Shank Inches	I.D. Horn Inches	Display Pkg. - 5 Cards 1 Pair per Card	Weight per Pair Ounces
1/2	2-1/8	2	829 DP0 PLB	14
1/2	2-1/8	2-1/4	829 DP1 PLB	16



Fig. 828

FIG. 828 - RIBBED TYPE ROWLOCK HORNS

PLAIN MANGANESE BRONZE

ORDERING INFORMATION

O.D. Shank Inches	Length Shank Inches	Between Horns Inches	Display Pkg. - 5 Cards 1 Pair per Card	Weight per Pair Ounces
1/2	2-1/8	2	828 DP PLB	13



Fig. 831

FIGS. 831, 832 & 833 - ROWLOCK SOCKETS

PLAIN MANGANESE BRONZE

ORDERING INFORMATION



Fig. 832



Fig. 833

Mount	Length Inches	Width Inches	Depth Inches	Display Pkg. - 5 Cards 1 Pair per Card	Weight per Pair Ounces
Top	2-3/8	7/8	1	831 DP PLB	4
Side	3-5/8	---	1-3/8	832 DP PLB	7
Edge	4	3/4	1-3/4	833 DP PLB	8

Screw Size #10.

DECK HARDWARE, CLEATS, CHOCKS, BITTS, BOW EYES, ROWLOCKS, WINDSHIELD & HATCH ADJUSTERS

WINDSHIELD ADJUSTERS

FIG. 359 - WINDSHIELD ADJUSTERS

**BLACK ANODIZED ALUMINUM SLIDE ON BLACK PLASTIC TRACK.
CHROME PLATED BRASS ARM.
BLACK PLASTIC KNOB AND END FITTINGS.**

ORDERING INFORMATION

Length Overall Inches	Length Adjustment Inches	Standard Pkg. - 1 Each	Screw Size	Weight Pounds
9	4-3/4	359 001 BLK	8	1/2
14	9-3/8	359 002 BLK	8	3/4
19	14-5/8	359 003 BLK	8	1



FIG. 359

FIG. 1290 & 1291 - WINDSHIELD ADJUSTERS

**CHROME PLATED ZINC
BLACK PLASTIC KNOB**

**FIG. 1290 - SIDE MOUNT
FIG. 1291 - OFFSET MOUNT**

ORDERING INFORMATION

Length Overall Inches	Length Adjustment Inches	Display Pkg. - 5 Cards 1 Pair per Card	OEM Bulk Pkg. 10 Pair	Screw Size	Weight per Pair Pounds
12	9-1/2	1290 DP CHR	1290 000 CHR	8	1-1/2
12	9-1/2	1291 DP CHR	1291 000 CHR	8	1-1/2



**FIG. 1290
SIDE MOUNT**

**FIG. 1291
OFFSET MOUNT**

SPARE PARTS ORDERING INFORMATION

Figure No.	Port Adjuster	Starboard Adjuster	Mounting Bracket With Knob	Knob Only
1290	1290 P00 99A	1290 S00 99A	1290 000 99B	1292 000 BLK
1291	1291 P00 99A	1291 S00 99A	1291 000 99B	1292 000 BLK

NOTE: Illustration is Port Side.

**FIG. 82 - WINDSHIELD ADJUSTER
CHROME PLATED BRASS AND BRONZE
BLACK PLASTIC KNOB**

ORDERING INFORMATION

Length Overall Inches	Length Adjustment Inches	Standard Pkg. - 1 Pair	Screw Size	Weight per Pair Pounds
12	9-1/2	82 000 CHR	8	2-3/8



FIG. 82

Spare Port Adjuster, Cat. No. 82 P00 99B.
Spare Starboard Adjuster, Cat. No. 82 S00 99B.
Spare Knob, Cat. No. 82 000 99A.

NOTE: Illustration is Port Side.

DECK HARDWARE, CLEATS, CHOCKS, BITTS, BOW EYES, ROWLOCKS, WINDSHIELD & HATCH ADJUSTERS

WINDSHIELD ADJUSTERS

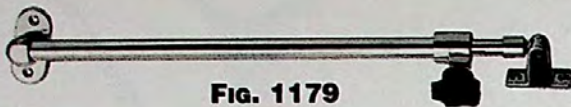

Fig. 1179

FIG. 1179 - WINDSHIELD ADJUSTER

**CHROME PLATED BRASS AND ZINC
BLACK PLASTIC KNOB**

ORDERING INFORMATION

Length Closed Inches	Length Open Inches	O.D. Tube Inches	Display Pkg. - 5 Cards 1 Pc. per Card	OEM Bulk Pkg. 20 Pcs.	Screw Size	Weight Ounces
10	18	1/2	1179 DP1 CHR	1179 001 CHR	6	9
12	20	1/2	1179 DP2 CHR	1179 002 CHR	6	11

Spare Knob, Cat. No. 1117 DP BLK.

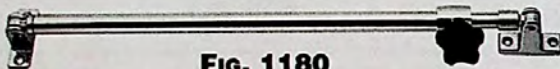

Fig. 1180

FIG. 1180 - WINDSHIELD ADJUSTER

**CHROME PLATED BRASS AND ZINC
BLACK PLASTIC KNOB**

ORDERING INFORMATION

Length Closed Inches	Length Open Inches	O.D. Tube Inches	Display Pkg. - 5 Cards 1 Pc. per Card	OEM Bulk Pkg. 20 Pcs.	Screw Size	Weight Ounces
12	21	1/2	1180 DP CHR	1180 000 CHR	6	10

Spare Knob, Cat. No. 1117 DP BLK.

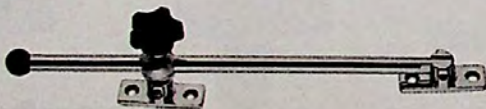

Fig. 1116

FIG. 1116 - WINDSHIELD ADJUSTER

**CHROME PLATED BRASS AND ZINC
BLACK PLASTIC KNOB**

ORDERING INFORMATION

Length Rod Inches	O.D. Rod Inches	Display Pkg. - 5 Cards 1 Pc. per Card	OEM Bulk Pkg. 20 Pcs.	Screw Size	Weight Ounces
8	3/8	1116 DP1 CHR	1116 001 CHR	8	8
10	3/8	1116 DP2 CHR	1116 002 CHR	8	10
12	3/8	1116 DP3 CHR	1116 003 CHR	8	12

Spare Knob, Cat. No. 1117 DP BLK.

DECK HARDWARE, CLEATS, CHOCKS, BITTS, BOW EYES, ROWLOCKS, WINDSHIELD & HATCH ADJUSTERS

HATCH ADJUSTER, BRACES & FASTENER

FIG. 797 - HATCH ADJUSTER



**CHROME PLATED BRASS AND ZINC
BLACK PLASTIC KNOB**

ORDERING INFORMATION

Length Arm Inches	Length Adjustment Inches	Length Slide Inches	Display Pkg. - 5 Cards 1 Pc. per Card	Screw Size	Weight Ounces
10	9-1/2	10-3/4	797 DP CHR	8	13

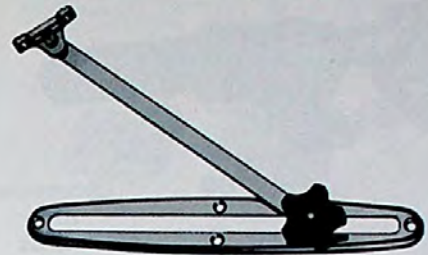

FIG. 797

FIG. 762 - HATCH SUPPORT BRACES



CHROME PLATED BRASS

ORDERING INFORMATION

Length Open Inches	Display Pkg. - 5 Cards 1 Pair per Card	OEM Bulk Pkg. 20 Pair	Screw Size	Weight per Pair Ounces
10	762 DP1 CHR	762 001 CHR	8	10
12	762 DP2 CHR	762 002 CHR	8	12
14	762 DP3 CHR	762 003 CHR	8	14

NOTE: Illustration is Port Side.



FIG. 762

FIG. 155 - HATCH FASTENER OR WINDSHIELD KEEPER



**CHROME PLATED BRASS AND ZINC
PHOSPHOR BRONZE SPRING**

ORDERING INFORMATION

Length Overall Inches	Dimensions Mounting Base Inches	Display Pkg. - 5 Cards 1 Pc. per Card	OEM Bulk Pkg. 50 Pcs.	Screw Size	Weight Ounces
3-7/8	1-1/2 x 9/16	155 DP CHR	155 000 CHR	6	3-1/4



FIG. 155

DECK HARDWARE, CLEATS, CHOCKS, BITTS, BOW EYES, ROWLOCKS, WINDSHIELD & HATCH ADJUSTERS

HATCH FASTENERS OR WINDSHIELD KEEPERS



FIG. 769 - HATCH FASTENER OR WINDSHIELD KEEPER



**CHROME PLATED BRASS AND ZINC
BLACK PLASTIC KNOB**

ORDERING INFORMATION

Fig. 769

Dimensions Base Inches	Display Pkg. - 5 Cards 1 Pc. per Card	OEM Bulk Pkg. 25 Pcs.	Screw Size	Weight Ounces
1-1/2 x 5/8	769 DP CHR	769 000 CHR	8	6

Spare Keeper, Cat. No. 769 000 99A.
Spare Handle with Stud, Cat. No. 769 000 99C.



FIG. 697 - HATCH FASTENER OR WINDSHIELD KEEPER



CHROME PLATED BRASS AND ZINC

ORDERING INFORMATION

Fig. 697

Length Bolt Inches	Dimensions Bracket Inches	Dimensions Keeper Inches	Display Pkg. - 10 Cards 1 Pc. per Card	Screw Size	Weight Ounces
1-1/2	1-1/2 x 5/8	1-1/2 x 3/4	697 DP CHR	8	3



FIG. 967 - HATCH FASTENER OR WINDSHIELD KEEPER



CHROME PLATED BRONZE

ORDERING INFORMATION

Fig. 967

Length Bolt Inches	Dimensions Bracket Inches	Dimensions Keeper Inches	Display Pkg. - 5 Cards 1 Pc. per Card	Screw Size	Weight Ounces
1-1/2	1-9/16 x 1	1-7/8 x 7/8	967 DP CHR	8	6



FIG. 770 - HATCH FASTENER



**CHROME PLATED BRONZE
BLACK PLASTIC KNOB**

ORDERING INFORMATION

Fig. 770

Dimensions Overall Inches	Adjustment Thread Inches	Display Pkg. - 5 Cards 1 Pc. per Card	OEM Bulk Pkg. 25 Pcs.	Screw Size	Weight Ounces
3-1/2 x 1-5/8	7/8	770 DP CHR	770 000 CHR	8	6

HOLD-DOWN CLAMPS



FIG. 1112 - HOLD-DOWN CLAMP

CHROME PLATED BRONZE

Flat Mounting



FIG. 1112

ORDERING INFORMATION

Length Inches	Width Inches	Display Pkg. - 5 Cards 1 Pc. per Card	OEM Bulk Pkg. 25 Pcs.	Screw Size	Weight Ounces
3	1-1/2	1112 DP CHR	1112 000 CHR	8	5-1/2

FIG. 1113 - HOLD-DOWN CLAMP

CHROME PLATED BRONZE

Right Angle Mounting



FIG. 1113

ORDERING INFORMATION

Length Inches	Width Inches	Display Pkg. - 5 Cards 1 Pc. per Card	OEM Bulk Pkg. 25 Pcs.	Screw Size	Weight Ounces
2-1/2	1-1/2	1113 DP CHR	1113 000 CHR	8	5-1/2

FIG. 1108 - LOCKABLE HOLD-DOWN CLAMP

CHROME PLATED BRONZE

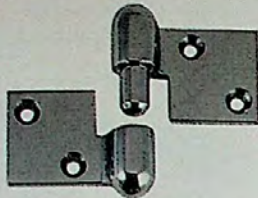

FIG. 1108

ORDERING INFORMATION

Dimensions Base Inches	Clearance Padlock Inches	Display Pkg. - 5 Cards 1 Pc. per Card	OEM Bulk Pkg. 25 Pcs.	Screw Size	Weight Ounces
2-3/4 x 1-3/4	1/4	1108 DP CHR	1108 000 CHR	6	4

PULL APART HINGES, HATCH TRIM & CONTINUOUS HINGE

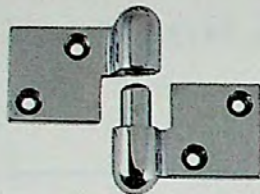

**FIG. 149
LEFT HAND**

FIGS. 149 & 152 - PULL APART HINGES

CHROME PLATED BRONZE

**FIG. 149 - LEFT HAND
FIG. 152 - RIGHT HAND**



**FIG. 152
RIGHT HAND**

Use 2 Left Hand or 2 Right Hand For Quick Removal of Hatches, Motor Covers, etc. or Together (1 each Left & Right) as a Heavy Duty Hinge Set.

ORDERING INFORMATION

	Length Open Inches	Width Overall Inches	Display Pkg. - 5 Cards		Screw Size	Weight Ounces
			1 Pc. per Card	OEM Pkg. - 25 Pcs.		
	3-3/4	2	149 DP CHR	149 000 CHR	10	5-1/2
	3-3/4	2	152 DP CHR	152 000 CHR	10	5-1/2

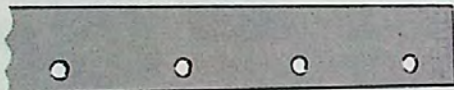

FIG. 258

FIG. 258 - HATCH TRIM

POLISHED STAINLESS STEEL

ORDERING INFORMATION

	Width Inches	Length Overall Inches	Standard Pkg. - 10 Pcs.	Screw Size	Weight Pounds
	1-1/4	72	258 002 STS	6	1
	1-1/2	72	258 004 STS	6	1-1/2

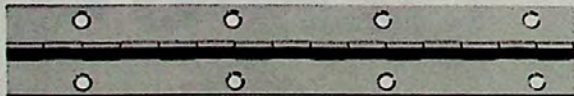

FIG. 212

FIG. 212 - CONTINUOUS HINGE

POLISHED STAINLESS STEEL

Countersunk holes are two inches apart, center to center.

ORDERING INFORMATION

	Width Open Inches	Length Overall Inches	Standard Pkg. - 10 Pcs.	Screw Size	Weight Pounds
	1-1/4	72	212 002 STS	5	1-1/2
	1-1/2	72	212 004 STS	5	2



BUTT HINGES



FIG. 1002 - BUTT HINGE

**HEAVY GAUGE EXTRUDED BRASS
CHROME PLATED
FAST PIN**

ORDERING INFORMATION

Height Pin Inches	Width Open Inches	Display Pkg. 1 Pair per Card	Cards per Pkg.	Standard Pkg. Catalog No.	Std. Pkg. Pair	Screw Size	No. of Holes	Weight per Pair Pounds
2	1-1/2	1002 003 DP	5	1002 003 CHR	5	6	4	1/4
2	2	1002 004 DP	5	1002 004 CHR	5	6	6	3/8
2-1/2	2-1/2	-----	---	1002 006 CHR	5	8	6	5/8
3	2	1002 007 DP	5	1002 007 CHR	5	8	6	5/8
3	2-1/2	-----	---	1002 008 CHR	5	8	6	3/4
3	3	1002 009 DP	5	1002 009 CHR	5	10	6	1-1/4
3-1/2	2-1/2	-----	---	1002 010 CHR	1	10	6	7/8
3-1/2	3	-----	---	1002 011 CHR	1	10	6	1-1/4
4	3	1002 012 DP	1	1002 012 CHR	1	10	6	1-1/2
4	4	1002 013 DP	1	1002 013 CHR	1	1/4	6	1-3/4
5	4	-----	---	1002 014 CHR	1	1/4	8	2-1/4

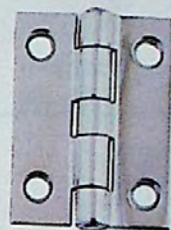
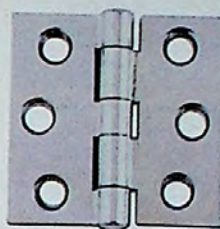

FIG. 1002

FIG. 1004 - BUTT HINGE



**CHROME PLATED EXTRUDED BRASS
EXTRA HEAVY DUTY, PLASTIC BEARINGS
REMOVABLE PIN**

For Transom Doors and Other Applications
Where Extra Strength is Required.

ORDERING INFORMATION

Height Pin Inches	Width Open Inches	Display Pkg. - 1 Card 1 Pair per Card	Screw Size	No. of Holes	Weight per Pair Pounds
4	4	1004 DP CHR	1/4	6	1-1/2

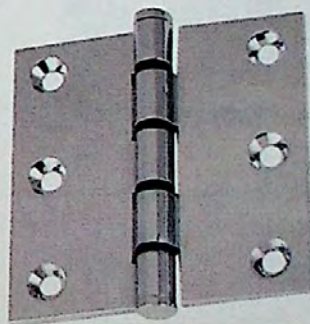

FIG. 1004

BUTT HINGES



FIG. 1293 - BUTT HINGE

**CHROME PLATED ZINC
REMOVABLE PIN**

ORDERING INFORMATION

Height Pin Inches	Width Open Inches	Display Pkg. - 5 Cards 1 Pair per Card	OEM Bulk Pkg. 25 Pair	Screw Size	No. of Holes	Weight per Pair Ounces
1-1/2	1-1/2	1293 DP2 CHR	-----	8	4	2
2	1-1/2	1293 DP3 CHR	-----	8	4	2-1/2
2	2	1293 DP4 CHR	*1293 004 CHR	8	4	3
2-1/2	2	1293 DP5 CHR	1293 005 CHR	8	6	4-1/2
2-1/2	2-1/2	1293 DP6 CHR	1293 006 CHR	8	6	5
3	3	1293 DP9 CHR	1293 009 CHR	10	6	7-1/2

* OEM Bulk Pkg. - 50 Pair.

FIG. 1293

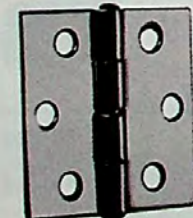

FIG. 949 - BUTT HINGE

**HEAVY GAUGE STAMPED BRASS
CHROME PLATED
FAST PIN**

ORDERING INFORMATION

Height Pin Inches	Width Open Inches	Chrome Plated Brass Display Pkg. - 5 Cards 1 Pair per Card	Chrome Plated Brass OEM Bulk Pkg. 25 Pair	Screw Size	No. of Holes	Weight per Pair Ounces
1-1/2	1-1/4	949 DP1 CHR	-----	6	4	2
1-1/2	1-1/2	949 DP2 CHR	-----	6	4	2-1/2
2	1-1/2	949 DP3 CHR	-----	6	4	2-3/4
2	2	949 DP4 CHR	949 004 CHR	6	6	4
2-1/2	2	949 DP5 CHR	949 005 CHR	8	6	5
2-1/2	2-1/2	949 DP6 CHR	949 006 CHR	8	6	6-3/4
3	3	949 DP9 CHR	949 009 CHR	10	6	9-1/2

FIG. 949



FIG. 941 - BUTT HINGE

CHROME PLATED ZINC

ORDERING INFORMATION

Height Pin Inches	Width Open Inches	Display Pkg. - 5 Cards 1 Pair per Card	OEM Bulk Pkg. 50 Pair	Screw Size	Weight per Pair Ounces
1-1/2	1-1/2	941 DP CHR	941 000 CHR	8	2-1/2

FIG. 941

HINGES



FIG. 952 - BUTT HINGE

**HEAVY GAUGE STAMPED BRASS
CHROME PLATED
REMOVABLE PIN**

ORDERING INFORMATION

Height Pin Inches	Width Open Inches	Chrome Plated Brass Display Pkg. - 5 Cards 1 Pair per Card	Chrome Plated Brass OEM Bulk Pkg. 25 Pair	Screw Size	No. of Holes	Weight per Pair Ounces
1-1/2	1-1/4	952 DP1 CHR	-----	6	4	2
1-1/2	1-1/2	952 DP2 CHR	-----	6	4	2-1/2
2	1-1/2	952 DP3 CHR	-----	6	4	2-3/4
2	2	952 DP4 CHR	952 004 CHR	6	6	4
2-1/2	2	952 DP5 CHR	952 005 CHR	8	6	5
2-1/2	2-1/2	952 DP6 CHR	-----	8	6	6-3/4
3	3	952 DP9 CHR	952 009 CHR	10	6	9-1/2

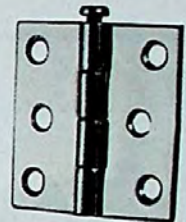
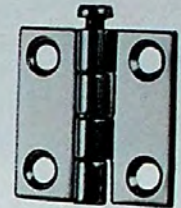

FIG. 952



FIG. 773 - HINGE

**CHROME PLATED BRONZE
REMOVABLE PIN**

ORDERING INFORMATION

Length Overall Inches	Width Overall Inches	Display Pkg. - 2 Cards 1 Pair per Card	Screw Size	Weight per Pair Pounds
3-1/8	2-5/8	773 DP CHR	10	1-5/8



FIG. 773



FIG. 951 - HINGE

CHROME PLATED BRONZE

ORDERING INFORMATION

Width Open Inches	Height Pin Inches	Display Pkg. - 5 Cards 1 Pair per Card	OEM Bulk Pkg. 25 Pair	Screw Size	Weight per Pair Ounces
3	1-1/2	951 DP1 CHR	951 001 CHR	8	3-1/2
4	1-1/2	951 DP2 CHR	951 002 CHR	8	5-1/2



FIG. 951



Fig. 808

Width Open Inches	Height Pin Inches	Display Pkg. - 10 Cards 1 Pair per Card	OEM Bulk Pkg. 50 Pair	Screw Size	Weight per Pair Ounces
3	1-1/2	808 DP CHR	808 000 CHR	8	3-1/2

FIG. 808 - HINGE

CHROME PLATED ZINC

ORDERING INFORMATION



Fig. 987

CHROME PLATED BRONZE

Fig. 1213

CHROME PLATED ZINC

Width Open Inches	Height Pin Inches	Width Shortside Inches	Display Pkg. - 5 Cards 1 Pair per Card	OEM Bulk Pkg. 50 Pair	Screw Size	Weight per Pair Ounces
2-1/4	1-1/2	3/4	987 DP1 CHR	987 001 CHR	8	3-1/2
2-3/4	1-1/2	3/4	987 DP2 CHR	-----	8	4
2-1/2	1-1/2	3/4	1213 DP1 CHR	1213 001 CHR	8	3

FIGS. 987 & 1213 - SHORTSIDE HINGES

FIG. 987 - CHROME PLATED BRONZE

FIG. 1213 - CHROME PLATED ZINC

ORDERING INFORMATION



Fig. 988

CHROME PLATED BRONZE

Fig. 1214

CHROME PLATED ZINC

Width Open Inches	Height Pin Inches	Width Shortside Inches	Offset Inches	Display Pkg. - 5 Cards 1 Pair per Card	Screw Size	Weight per Pair Ounces
2-1/4	1-1/2	3/4	3/8	988 DP1 CHR	8	4
2-3/4	1-1/2	3/4	3/8	988 DP2 CHR	8	5
2-1/2	1-1/2	3/4	3/8	1214 DP1 CHR	8	4

FIGS. 988 & 1214 - OFFSET SHORTSIDE HINGES

FIG. 988 - CHROME PLATED BRONZE

FIG. 1214 - CHROME PLATED ZINC

ORDERING INFORMATION



Fig. 999

Width Open Inches	Height Pin Inches	Width Shortside Inches	Display Pkg. - 5 Cards 1 Pair per Card	Screw Size	Weight per Pair Ounces
3-1/2	1-1/2	1-1/2	999 DP CHR	8	5

FIG. 999 - SHORTSIDE HINGE

CHROME PLATED BRONZE

ORDERING INFORMATION

HINGES

FIG. 942 - OFFSET HINGE



CHROME PLATED ZINC

ORDERING INFORMATION

Width Open Inches	Height Pin Inches	Offset Inches	Display Pkg. - 5 Cards 1 Pair per Card	OEM Bulk Pkg. 50 Pair	Screw Size	Weight per Pair Ounces
1-1/2	1-1/2	3/8	942 DP CHR	942 000 CHR	8	2-1/2

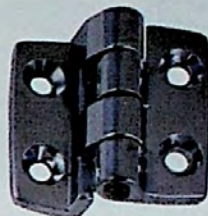

FIG. 942

FIG. 271 - INSET HINGE



**SEMI-CONCEALED
FOR INSET DOORS**

**CHROME PLATED
STAMPED BRASS**

3/8 INCH INSET

ORDERING INFORMATION

Dimensions Inches	Display Pkg. - 10 Cards 1 Pair per Card	OEM Bulk Pkg. 100 Pair	Screw Size	Weight per Pair Ounces
2-3/4 x 2-1/8	271 DP CHR	271 000 CHR	4	2-1/2

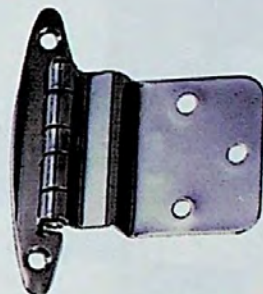

FIG. 271

FIG. 272 - FLUSH HINGE



**SEMI-CONCEALED
FOR OVERLAY DOORS**

**CHROME PLATED
STAMPED BRASS**

ORDERING INFORMATION

Dimensions Inches	Display Pkg. - 10 Cards 1 Pair per Card	OEM Bulk Pkg. 100 Pair	Screw Size	Weight per Pair Ounces
2-3/4 x 2-1/8	272 DP CHR	272 000 CHR	4	2-1/2

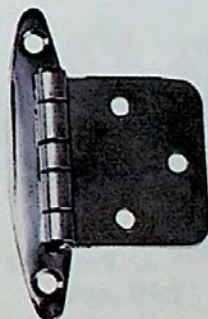

FIG. 272



FIG. 120 - STRAP HINGE



FIG. 120

CHROME PLATED BRONZE

ORDERING INFORMATION

Width Open Inches	Height Pin Inches	Display Pkg. - 5 Cards 1 Pair per Card	Screw Size	No. of Holes	Weight per Pair Ounces
4	1-1/8	120 DP1 CHR	10	4	6
6	1-1/8	120 DP2 CHR	10	6	8
8	1-1/8	120 DP3 CHR	12	6	16



FIG. 122 - SHORTSIDE STRAP HINGE



FIG. 122

CHROME PLATED BRONZE

ORDERING INFORMATION

Width Open Inches	Height Pin Inches	Length Shortside Inches	Display Pkg. - 5 Cards 1 Pair per Card	Screw Size	No. of Holes	Weight per Pair Ounces
4-7/8	1-1/8	2-1/16	122 DP CHR	10	5	7



FIG. 197 - "T" HINGE

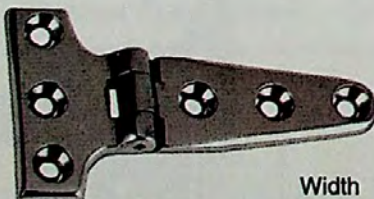

FIG. 197

CHROME PLATED BRONZE

ORDERING INFORMATION

Width Open Inches	Height Overall Inches	Width "T" Side Inches	Display Pkg. - 5 Cards 1 Pair per Card	Screw Size	No. of Holes	Weight per Pair Ounces
4	2-1/8	1-5/16	197 DP1 CHR	10	6	8
6	3	1-1/2	197 DP2 CHR	10	7	16
8	3-7/8	2	197 DP3 CHR*	12	8	25

* Display Pkg. - 2 Cards, 1 Pair per Card.

HINGES & HASP

FIG. 924 - HINGE

CHROME PLATED STAMPED BRASS

ORDERING INFORMATION

Width Open Inches	Height Pin Inches	Display Pkg. - 10 Cards 1 Pair per Card	Screw Size	Weight per Pair Ounces
3	1-1/2	924 DP CHR	6	2-1/2

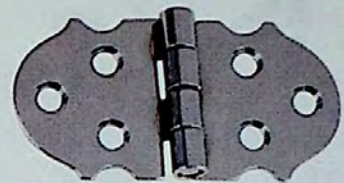

FIG. 924



FIG. 957 - NON-MORTISED HINGE

**STAMPED BRASS
CHROME PLATED**

Easily Installs Without Mortising.

ORDERING INFORMATION

Height Pin Inches	Width Closed Inches	Display Pkg. - 5 Cards 1 Pair per Card	OEM Bulk Pkg. 50 Pair	Screw Size	Weight per Pair Ounces
3-3/8	7/8	957 DP CHR	957 000 CHR	8	4

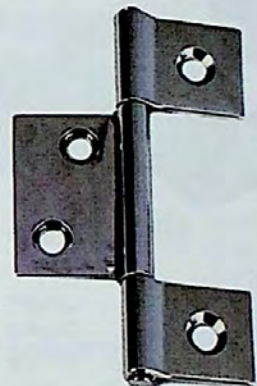

FIG. 957



FIG. 998 - HASP

CHROME PLATED BRONZE

ORDERING INFORMATION

Length Closed Inches	Width Overall Inches	Padlock Clearance Inches	Display Pkg. - 10 Cards 1 Pc. per Card	OEM Bulk Pkg. 25 Pcs.	Screw Size	Weight Ounces
2	1	9/32	998 DP1 CHR	998 001 CHR	6	2
3	1	9/32	998 DP2 CHR	998 002 CHR	6	3



FIG. 998



Spare Chrome Keepers (2 per card), Cat. No. 959 DP CHR.

CABINET & DOOR HARDWARE, LOCKS & LATCHES, HINGES AND HOOKS

HASPS & BARREL BOLT



Fig. 1198

Length Closed Inches	Width Inches	Padlock Clearance Inches
2	1	1/4
3	1	1/4
3-3/4	1	1/4

FIG. 1198 - HASP

CHROME PLATED ZINC

ORDERING INFORMATION

Display Pkg. - 10 Cards 1 Pc. per Card	OEM Bulk Pkg. 25 Pcs.	Screw Size	Weight Ounces
1198 DP1 CHR	1198 001 CHR	6	1-1/2
1198 DP2 CHR	1198 002 CHR	6	2-1/4
1198 DP3 CHR	1198 003 CHR	6	2-1/2

Spare Keepers (2 per card), Cat. No. 1261 DP CHR.



Fig. 1194

FIG. 1194 - SWIVEL EYE HASP

CHROME PLATED ZINC

Padlock Eye Swivels to Act as a Latch.

ORDERING INFORMATION

Length Closed Inches	Width Inches	Padlock Clearance Inches	Display Pkg. - 10 Cards 1 Pc. per Card	OEM Bulk Pkg. 50 Pcs.	Screw Size	Weight Ounces
3	1	11/32	1194 DP CHR	1194 000 CHR	6	2-1/2

Spare Keepers (1 per card), Cat. No. 1194 DP 99A.

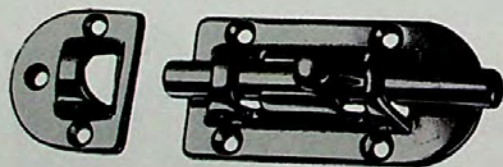

Fig. 947

FIG. 947 - BARREL BOLT

CHROME PLATED BRONZE

Supplied with Friction Pad to Eliminate Rattle and Provide Smooth Operation.

ORDERING INFORMATION

Dimensions Overall Inches	Chrome Plated Bronze Display Pkg. - 5 Cards 1 Pc. per Card	Chrome Plated Bronze OEM Bulk Pkg. 25 Pcs.	Screw Size	Weight Ounces
3-7/16 x 1-7/16	947 DP1 CHR	947 001 CHR	6	4
4-5/16 x 1-7/16	947 DP2 CHR	947 002 CHR	6	4-1/2
5-1/4 x 1-7/16	947 DP3 CHR	947 003 CHR	6	5

BOLTS & HOOKS

FIG. 1244 - BARREL BOLT



CHROME PLATED ZINC

Integral Friction Pad Eliminates Rattle and Provides Smooth Operation.

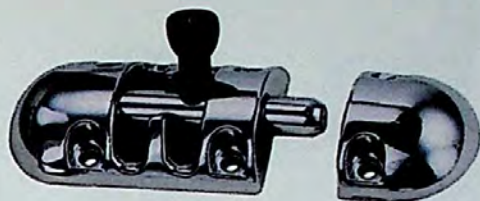

Fig. 1244

ORDERING INFORMATION

Dimensions	Display Pkg. - 5 Cards	OEM Bulk Pkg.	Screw Size	Weight Ounces
Overall Inches	1 Pc. per Card	25 Pcs.		
3-3/8 x 1-1/4	1244 DP CHR	1244 000 CHR	6 R.H.	3

FIG. 1053 - SHIP BOLT



CHROME PLATED BRONZE

Supplied with Brass Friction Spring to Eliminate Rattle and Provide Detented Operation.

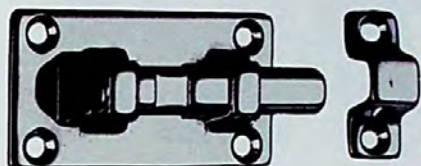

Fig. 1053

ORDERING INFORMATION

Dimensions	Display Pkg. - 5 Cards	OEM Bulk Pkg.	Screw Size	Weight Ounces
Overall Inches	1 Pc. per Card	25 Pcs.		
2-5/8 x 1-1/4	1053 DP CHR	1053 000 CHR	6	1-3/4

FIG. 956 - CABIN DOOR HOOK



**CAST BRONZE
PLAIN OR CHROME PLATED**

ORDERING INFORMATION



Fig. 956

Length Hook Inches	Chrome Plated Bronze	Chrome Plated Bronze	Plain Bronze Standard	Weight Ounces
	Display Pkg. - 5 Cards	OEM Bulk Pkg.	Pkg. - 5 Pcs.	
	1 Pc. per Card	50 Pcs.		
1-1/2	956 DP1 CHR	956 001 CHR	956 001 PLB	1
2	956 DP2 CHR	956 002 CHR	956 002 PLB	1-1/2
2-1/2	956 DP3 CHR	956 003 CHR	956 003 PLB	1-3/4
3	956 DP4 CHR	956 004 CHR	956 004 PLB	2
3-1/2	956 DP5 CHR	-----	956 005 PLB	2-1/2
4	956 DP6 CHR	-----	956 006 PLB	3
5	956 DP7 CHR	-----	956 007 PLB	3-1/2
6	956 DP8 CHR	*956 008 CHR	956 008 PLB	5

*O.E.M. Bulk Pkg. - 25 pcs.

Screw Size #6.

Spare Plain Keepers, (2 per card), Cat. No. 959 DP PLB.

Spare Chrome Keepers, (2 per card), Cat. No. 959 DP CHR

Spare Chrome Keepers, O.E.M Bulk (100 pcs.) Cat. No. 959 000 CHR

HOOKS, DOOR STOPS & HOLDER



FIG. 1199 - CABIN DOOR HOOK

CHROME PLATED ZINC

ORDERING INFORMATION



FIG. 1199

Length Hook Inches	Display Pkg. - 20 Cards 1 Pc. per Card	OEM Bulk Pkg. 50 Pcs.	Screw Size	Weight Ounces
1-3/4	1199 DP1 CHR	1199 001 CHR	6	1-1/4
2-1/4	1199 DP2 CHR	1199 002 CHR	6	1-3/8
3	1199 DP3 CHR	1199 003 CHR	6	1-1/2
4	1199 DP4 CHR	1199 004 CHR	6	1-3/4

Spare Keepers, (2 per card), Cat. No. 1261 DP CHR.



FIG. 1287 - CABIN DOOR HOOK

CHROME PLATED ZINC

ORDERING INFORMATION



FIG. 1287

Length Hook Inches	Display Pkg. - 20 Cards 1 Pc. per Card	OEM Bulk Pkg. 50 Pcs.	Screw Size	Weight Ounces
2	1287 DP1 CHR	1287 001 CHR	6	1-1/4
2-1/2	1287 DP2 CHR	1287 002 CHR	6	1-1/2
3	1287 DP3 CHR	1287 003 CHR	6	1-3/4

Spare Keepers, (2 per card), Cat. No. 1261 DP CHR.



FIG. 574 - DOOR STOP AND HOLDER

**CHROME PLATED BRONZE
RUBBER BUMPER**

ORDERING INFORMATION



FIG. 574

Length Inches	O.D. Inches	Display Pkg. - 5 Cards 1 Pc. per Card	OEM Bulk Pkg. 25 Pcs.	Stop Screw Size	Keeper Screw Size	Weight Ounces
2-3/8	1-3/4	574 DP1 CHR	574 001 CHR	8	6	4-1/2
3-1/4	1-3/4	574 DP2 CHR	574 002 CHR	8	6	5-1/2



FIG. 1177 - DOOR STOP

**CHROME PLATED ZINC
RUBBER BUMPER**

ORDERING INFORMATION



FIG. 1177

Length Inches	O.D. Inches	Display Pkg. - 5 Cards 1 Pc. per Card	OEM Bulk Pkg. 50 Pcs.	Screw Size	Weight Ounces
1	1-1/4	1177 DP CHR	1177 000 CHR	4	1

DOOR HOLDER, CATCH & BUTTONS

FIG. 1065 - DOOR HOLDER

**STAINLESS STEEL CLIP
CHROME PLATED ZINC ARROW**

ORDERING INFORMATION

Dimensions Arrow Base Inches	Dimensions Clip Base Inches	Projection Inches	Display Pkg. - 5 Cards 1 Pc. per Card	Screw Size	Weight Ounces
1-5/8 x 3/4	1-3/8 x 7/16	1-3/4	1065 DP CHR	8	2

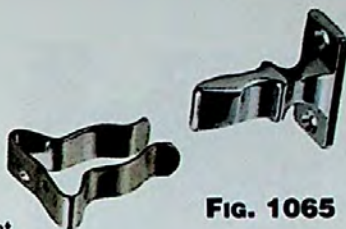

Fig. 1065

FIG. 554 - DOOR CATCH

**WHITE PLASTIC
STAINLESS STEEL
MOUNTING & KEEPER SCREWS**

ORDERING INFORMATION

Screw Size Inches	Dimensions Catch Inches	Display Pkg. - 25 Cards 2 Pcs. per Card	OEM Bulk Pkg. 100 Pcs.	Mounting Screw Size	Weight per 50 Ounces
3/4 x #8	1-1/4 x 5/8	554 DP	554	4 R.H.	4



Fig. 554

FIG. 559 - DOOR CATCH

BLACK PLASTIC

ORDERING INFORMATION

Dimensions Stud Inches	Dimensions Catch Inches	Display Pkg. - 25 Cards 2 Pcs. per Card	OEM Bulk Pkg. 100 Pcs.	Screw Size	Weight per 50 Ounces
1-1/8 x 3/8	1-3/8 x 7/8	559 DP	559	4 R.H.	4



Fig. 559

FIGS. 1216 & 1217 - DOOR BUTTONS

**CHROME PLATED ZINC
BLACK PLASTIC BUTTON**

Fig. 1216 - Supplied with Phosphor Bronze Tension Spring.
Fig. 1217 - Supplied without Spring and Requires a
No. 8 Oval-Head Pivot Screw.

ORDERING INFORMATION

Type	O.D. Overall Inches	Display Pkg. - 10 Cards 1 Pc. per Card	OEM Bulk Pkg. 50 Pcs.	Screw Size	Weight Ounces
With Spring	1-3/4	1216 DP CHR	1216 000 CHR	6	1-1/2
w/o Spring	1-3/4	1217 DP CHR	1217 000 CHR	6	1-1/2

Spare Button for Both, Cat. No. 1216 000 99A.



Fig. 1216



Fig. 1217

CUPBOARD BOLT, CATCH & TURNS

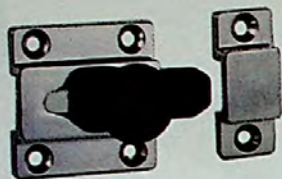

Fig. 1101

FIG. 1101 - CUPBOARD BOLT

**CHROME PLATED ZINC
BLACK PLASTIC SLIDE AND KNOB**

ORDERING INFORMATION

Dimensions Overall Inches	Display Pkg. - 5 Cards 1 Pc. per Card	OEM Bulk Pkg. 50 Pcs.	Screw Size	Weight Ounces
2-1/8 x 1-1/2	1101 DP CHR	1101 000 CHR	6	2

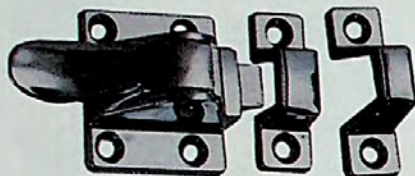

Fig. 1102

FIG. 1102 - CUPBOARD CATCH

CHROME PLATED ZINC

**No. 1 SUPPLIED WITH BOX STRIKE
No. 2 SUPPLIED WITH 3/8 INCH OFFSET BOX STRIKE**

ORDERING INFORMATION

Strike Type	Dimensions Overall Inches	Display Pkg. - 5 Cards 1 Pc. per Card	OEM Bulk Pkg. 50 Pcs.	Screw Size	Weight Ounces
Box	1-1/2 x 1-7/8	1102 DP1 CHR	1102 001 CHR	6	3-1/2
Offset Box	1-1/2 x 1-7/8	1102 DP2 CHR	1102 002 CHR	6	3-1/2

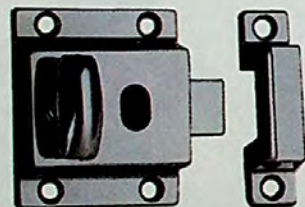

Fig. 978

FIG. 978 - CUPBOARD TURN

CHROME PLATED ZINC

ORDERING INFORMATION

Dimensions Overall Inches	Display Pkg. - 5 Cards 1 Pc. per Card	Screw Size	Weight Ounces
2-1/8 x 2-1/4	978 DP CHR	6	5

Spare Strike Plate, Cat. No. 976 000 CHR.
Spare Bevel with Cam, Cat. No. 984 000 CHR.

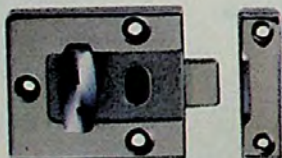

Fig. 986

FIG. 986 - CUPBOARD TURN

CHROME PLATED ZINC

ORDERING INFORMATION

Dimensions Overall Inches	Display Pkg. - 5 Cards 1 Pc. per Card	Screw Size	Weight Ounces
2 x 2-1/4	986 DP CHR	8	5

Spare Strike Plate, Cat. No. 977 000 CHR.
Spare Bevel with Cam, Cat. No. 984 000 CHR.

LATCHES & FLUSH LOCKS

FIG. 948 - LATCH



CHROME PLATED ZINC

SLIDING LOCK BUTTON

ORDERING INFORMATION

Dimensions Overall Inches	Display Pkg. - 5 Cards 1 Pc. per Card	Screw Size	Weight Ounces
2-1/8 x 2-1/4	948 DP CHR	6	5

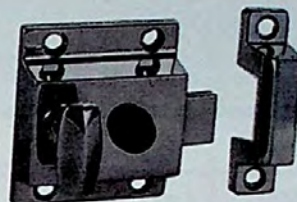

Fig. 948

Spare Strike Plate, Cat. No. 976 000 CHR.
Spare Bevel with Cam, Cat. No. 984 000 CHR.

FIG. 983 - LATCH



CHROME PLATED ZINC

SLIDING LOCK BUTTON

ORDERING INFORMATION

Dimensions Overall Inches	Display Pkg. - 5 Cards 1 Pc. per Card	Screw Size	Weight Ounces
2 x 2-1/4	983 DP CHR	8	5

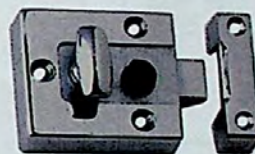

Fig. 983

Spare Strike Plate, Cat. No. 977 000 CHR.
Spare Bevel with Cam, Cat. No. 984 000 CHR.

FIGS. 921 & 922 - FLUSH LOCK & LATCH



CHROME PLATED ZINC

FIG. 921 - LOCKING LATCH WITH 2 KEYS

FIG. 922 - NON-LOCKING LATCH

Easily Installs in a 1-5/8 Inch Diameter Hole.

For Door Thickness 1/2 to 3/4 Inches.

ORDERING INFORMATION

Type	Dimensions Face Plate Inches	Display Pkg. - 5 Cards 1 Pc. per Card	OEM Bulk Pkg. 25 Pcs.	Weight Ounces
Lock	2-1/4 x 2	921 DP CHR	921 000 CHR	6-1/2
Latch	2-1/4 x 2	922 DP CHR	922 000 CHR	6

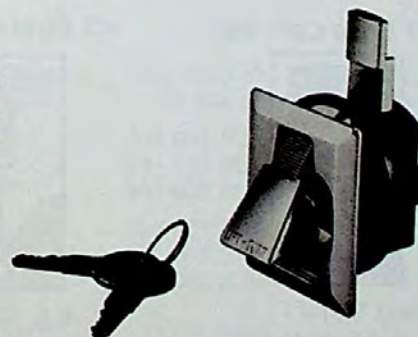

Fig. 921

Spare Chrome Cam Bar, Cat. No. 980A.
Old Style Spare Black Plastic Cam Bar, Cat. No. 980
Note: Chrome and Plastic Cam Bars are not interchangeable.

LOCKS & LATCH SETS SELECTION GUIDE

Series	Type	Size	Mounting Surface Thickness	Lock & Latch Set Features	Page
931	Lock	2-1/2" x 2-1/2"	1/4" to 1-1/8"	Available Black or White; #1 Flush Cam Bar; #2 Offset Adjustable Cam Bar; #3 Straight Cam Bar. Adjustable 3/8" to 3", used on doors etc.	163
932	Latch				
1071	Lock	2-7/8" x 2-7/8"	3/8" to 1-1/4"	Available Black or White; #1 Flush Cam Bar; #2 Offset Adjustable Cam Bar; #3 Straight Cam Bar. Used on carpeted surfaces. Adjustable 3/8" to 3". Stainless Steel Handle.	164
1072	Latch				
1081	Lock	2-7/8" x 2-7/8"	3/8" to 1-1/4"	Available Black or White; #1 Flush Cam Bar; #2 Offset Adjustable Cam Bar; #3 Straight Cam Bar. Used on smooth or carpeted surfaces. Adjustable 3/8" to 3". Stainless Steel Handle.	165
1082	Latch				
1011	Lock	2-7/8" x 2-7/8"	3/8" to 1-1/4"	Available Black only; #1 Flush Cam Bar; #2 Offset Adjustable Cam Bar; #3 Straight Cam Bar. Used on carpeted surfaces. Adjustable 3/8" to 3". Chrome plated zinc handle.	166
1012	Latch				
1031	Lock	3-1/8" x 3-1/8"	1/8" to 3/4"	Available Black or White. Flush Cam Bar only; Adjustable 1/2" to 3". Extra large handle.	166
1032	Latch				

#1 Style Cam Bar



e.g. 931 #1
Flush Cam Bar
with Flexible
Plastic Strike

#2 Style Cam Bar



e.g. 931 #2
Offset Adjustable
Cam Bar.

#3 Style Cam Bar



e.g. 931 #3
Straight Cam Bar
with Flexible
Plastic Strike

**Heavy Duty
#1 Style Cam Bar**



e.g. 1031 #1
Heavy Duty Flush
Cam Bar as used on
1031/1032 Strikes

FLUSH LOCKS & LATCHES

Figs. 931 & 932 - FLUSH LOCK & LATCH



**CHROME PLATED ZINC. BLACK OR WHITE PLASTIC,
WITH STAINLESS STEEL STEM AND LOCK NUT.**

FIG. 931 - LOCK WITH 2 KEYS
FIG. 932 - LATCH (NON-LOCKING)

**FLEXIBLE
PLASTIC
STRIKE**



No. 1 with Flush Cam Bar and Flexible Plastic Strike Plate.
No. 2 with Offset Adjustable Cam Bar.
No. 3 with Straight Cam Bar and Flexible Plastic Strike Plate.

Detents Indicate Open or Closed Position.
Easily Installs in a 2 Inch Diameter Hole.
For Door Thickness 1/4 to 1-1/8 Inches.



FIG.
931 #1 BLK



FIG.
932 #2 BLK



FIG.
931 #3 BLK

ORDERING INFORMATION

Finish	Type	Adjustment Latch Bar Inches	Dimensions Face Plate Inches	Display Pkg. - 5 Cards 1 Pc. per Card	OEM Bulk Pkg. 25 Pcs.	Weight Ounces
Black	Lock	3/8 to 3	2-1/2 x 2-1/2	931 DP1 BLK	931 001 BLK	8
Black	Lock	3/8 to 3	2-1/2 x 2-1/2	931 DP2 BLK	931 002 BLK	8-1/2
Black	Lock	1-1/16 to 2-9/16	2-1/2 x 2-1/2	931 DP3 BLK*	931 003 BLK*	6
Black	Latch	3/8 to 3	2-1/2 x 2-1/2	932 DP1 BLK	932 001 BLK	7
Black	Latch	3/8 to 3	2-1/2 x 2-1/2	932 DP2 BLK	932 002 BLK	7-1/2
Black	Latch	1-1/16 to 2-9/16	2-1/2 x 2-1/2	932 DP3 BLK*	932 003 BLK*	7
White	Lock	3/8 to 3	2-1/2 x 2-1/2	931 DP1 WHT	931 001 WHT	8
White	Lock	3/8 to 3	2-1/2 x 2-1/2	931 DP2 WHT	931 002 WHT	8-1/2
White	Lock	1-1/16 to 2-9/16	2-1/2 x 2-1/2	931 DP3 WHT*	931 003 WHT*	6
White	Latch	3/8 to 3	2-1/2 x 2-1/2	932 DP1 WHT	932 001 WHT	7
White	Latch	3/8 to 3	2-1/2 x 2-1/2	932 DP2 WHT	932 002 WHT	7-1/2
White	Latch	1-1/16 to 2-9/16	2-1/2 x 2-1/2	932 DP3 WHT*	932 003 WHT*	7

* New Item

Spare Flush Cam Bar, Cat. No. 931 001 99A.

Spare Offset Adjustable Cam Bar, Cat. No. 931 002 99A.

Spare Straight Cam Bar, Cat. No. 931 003 99A.

FLUSH LOCKS & LATCHES

FIGS. 1071 & 1072 - FLUSH LOCK & LATCH FOR CARPETED SURFACES

BLACK OR WHITE PLASTIC, WITH STAINLESS STEEL "D" RING HANDLE, STEM AND LOCK NUT. TWO O-RINGS FOR INCREASED WATER RESISTANCE. POSITION INDICATOR SHOWS OPEN OR CLOSED POSITION.

FIG. 1071 - LOCK WITH 2 KEYS
FIG. 1072 - LATCH (NON-LOCKING)

**FLEXIBLE
PLASTIC
STRIKE**



- No. 1 with Flush Cam Bar and Flexible Plastic Strike Plate.
- No. 2 with Offset Adjustable Cam Bar.
- No. 3 with Straight Cam Bar and Flexible Plastic Strike Plate.



Easily Installs in a 2-3/8 Inch Diameter Hole.
For Mounting Surfaces 3/8 to 1-1/4 Inches.



FIG.
1071 #1 BLK



FIG.
1072 #2 BLK



FIG.
1071 #3 BLK

ORDERING INFORMATION

Finish	Type	Adjustment Latch Bar Inches	Dimensions Face Plate Inches	OEM Bulk Pkg. 25 Pcs.	Weight Ounces
Black	Lock	3/8 to 3	2-7/8 x 2-7/8	1071 001 BLK	8
Black	Lock	3/8 to 3	2-7/8 x 2-7/8	1071 002 BLK	8-1/2
Black	Lock	1-1/16 to 2-9/16	2-7/8 x 2-7/8	1071 003 BLK	6
Black	Latch	3/8 to 3	2-7/8 x 2-7/8	1072 001 BLK	7
Black	Latch	3/8 to 3	2-7/8 x 2-7/8	1072 002 BLK	7-1/2
Black	Latch	1-1/16 to 2-9/16	2-7/8 x 2-7/8	1072 003 BLK	7
White	Lock	3/8 to 3	2-7/8 x 2-7/8	1071 001 WHT	8
White	Lock	3/8 to 3	2-7/8 x 2-7/8	1071 002 WHT	8-1/2
White	Lock	1-1/16 to 2-9/16	2-7/8 x 2-7/8	1071 003 WHT	6
White	Latch	3/8 to 3	2-7/8 x 2-7/8	1072 001 WHT	7
White	Latch	3/8 to 3	2-7/8 x 2-7/8	1072 002 WHT	7-1/2
White	Latch	1-1/16 to 2-9/16	2-7/8 x 2-7/8	1072 003 WHT	7

Spare Flush Cam Bar, Cat. No. 931 001 99A.
Spare Offset Adjustable Cam Bar, Cat. No. 931 002 99A.
Spare Straight Cam Bar, Cat. No. 931 003 99A.

FLUSH LOCKS & LATCHES

**FIGS. 1081 & 1082 - FLUSH LOCK & LATCH
FOR SMOOTH OR CARPETED SURFACES
(GASKET INCLUDED FOR SMOOTH SURFACE APPLICATIONS)**



BLACK OR WHITE PLASTIC, WITH STAINLESS STEEL "D" RING HANDLE, STEM AND LOCK NUT. TWO O-RINGS FOR INCREASED WATER RESISTANCE. POSITION INDICATOR SHOWS OPEN OR CLOSED POSITION.

**FLEXIBLE
PLASTIC
STRIKE**



**FIG. 1081 - LOCK WITH 2 KEYS
FIG. 1082 - LATCH (NON-LOCKING)**



No. 1 with Flush Cam Bar and Flexible Plastic Strike Plate.
No. 2 with Offset Adjustable Cam Bar.
No. 3 with Straight Cam Bar and Flexible Plastic Strike Plate.

Easily Installs in a 2-3/8 Inch Diameter Hole.
For Mounting Surfaces 3/8 to 1-1/4 Inches.



**FIG.
1081 #1 BLK**



**FIG.
1082 #2 BLK**



**FIG.
1081 #3 BLK**

ORDERING INFORMATION

Finish	Type	Adjustment Latch Bar Inches	Dimensions Face Plate Inches	Display Pkg. - 5 Cards 1 Pc. per Card	OEM Bulk Pkg. 25 Pcs.	Weight Ounces
Black	Lock	3/8 to 3	2-7/8 x 2-7/8	1081 DP1 BLK	1081 001 BLK	8
Black	Lock	3/8 to 3	2-7/8 x 2-7/8	1081 DP2 BLK	1081 002 BLK	8-1/2
Black	Lock	1-1/16 to 2-9/16	2-7/8 x 2-7/8	1081 DP3 BLK	1081 003 BLK	6
Black	Latch	3/8 to 3	2-7/8 x 2-7/8	1082 DP1 BLK	1082 001 BLK	7
Black	Latch	3/8 to 3	2-7/8 x 2-7/8	1082 DP2 BLK	1082 002 BLK	7-1/2
Black	Latch	1-1/16 to 2-9/16	2-7/8 x 2-7/8	1082 DP3 BLK	1082 003 BLK	7
White	Lock	3/8 to 3	2-7/8 x 2-7/8	1081 DP1 WHT	1081 001 WHT	8
White	Lock	3/8 to 3	2-7/8 x 2-7/8	1081 DP2 WHT	1081 002 WHT	8-1/2
White	Lock	1-1/16 to 2-9/16	2-7/8 x 2-7/8	1081 DP3 WHT	1081 003 WHT	6
White	Latch	3/8 to 3	2-7/8 x 2-7/8	1082 DP1 WHT	1082 001 WHT	7
White	Latch	3/8 to 3	2-7/8 x 2-7/8	1082 DP2 WHT	1082 002 WHT	7-1/2
White	Latch	1-1/16 to 2-9/16	2-7/8 x 2-7/8	1082 DP3 WHT	1082 003 WHT	7

Spare Flush Cam Bar, Cat. No. 931 001 99A.
Spare Offset Adjustable Cam Bar, Cat. No. 931 002 99A.
Spare Straight Cam Bar, Cat. No. 931 003 99A.

FLUSH LOCKS & LATCHES



FIG.
1011 #1 BLK



FIG.
1012 #2 BLK

FIGS. 1011 & 1012 - FLUSH LOCK & LATCH WITH CARPET GRIPPER TEETH

CHROME PLATED ZINC. BLACK PLASTIC, WITH STAINLESS STEEL STEM AND LOCK NUT.

FIG. 1011 - LOCK WITH 2 KEYS
FIG. 1012 - LATCH (NON-LOCKING)

No. 1 with Flush Cam Bar and Flexible Plastic Strike Plate.
No. 2 with Offset Adjustable Cam Bar.
No. 3 with Straight Cam Bar and Flexible Plastic Strike Plate.

Detents Indicate Open or Closed Position.
Easily Installs in a 2-3/8 Inch Diameter Hole.
For Door Thickness 3/8 to 1-1/4 Inches.

ORDERING INFORMATION

Type	Adjustment Latch Bar Inches	Dimensions Face Plate Inches	Display Pkg. - 5 Cards 1 Pc. per Card	OEM Bulk Pkg. 25 Pcs.	Weight Ounces
Lock	3/8 to 3	2-7/8 x 2-7/8	1011 DP1 BLK	1011 001 BLK	7-1/2
Lock	3/8 to 3	2-7/8 x 2-7/8	1011 DP2 BLK	1011 002 BLK	7
Lock	1-1/16 to 2-9/16	2-7/8 x 2-7/8	1011 DP3 BLK	1011 003 BLK	7-1/2
Latch	3/8 to 3	2-7/8 x 2-7/8	1012 DP1 BLK	1012 001 BLK	7-1/2
Latch	3/8 to 3	2-7/8 x 2-7/8	1012 DP2 BLK	1012 002 BLK	7
Latch	1-1/16 to 2-9/16	2-7/8 x 2-7/8	1012 DP3 BLK	1012 003 BLK	7

Spare Flush Cam Bar, Cat. No. 931 001 99A.
Spare Offset Adjustable Cam Bar, Cat. No. 931 002 99A.
Spare Straight Cam Bar, Cat. No. 931 003 99A.



FIG.
1012 #3 BLK

FLEXIBLE PLASTIC STRIKE



FIG. 1031



FIG. 1032

FIGS. 1031 & 1032 - FLUSH LOCK & LATCH

CHROME PLATED ZINC. BLACK OR WHITE PLASTIC, WITH STAINLESS STEEL STEM AND LOCK NUT.
LARGE HANDLE ALLOWS TWO FINGER GRIP.

FIG. 1031 - LOCK WITH 2 KEYS
FIG. 1032 - LATCH (NON-LOCKING)

Flush Mounts in a 2-3/8 x 2-3/8 Inch Hole.
Surface Mounts in a 1-5/8 Inch Diameter Hole
With Plastic Spacer Included.
For Door Thickness 1/8 to 3/4 Inches.

ORDERING INFORMATION

Finish	Type	Adjustment Latch Bar Inches	Dimensions Face Plate Inches	Display Pkg. - 5 Cards 1 Pc. per Card	OEM Bulk Pkg. 25 Pcs.	Weight Ounces
Black	Lock	1/2 to 3	3-1/8 x 3-1/8	1031 DP1 BLK	1031 001 BLK	10
Black	Latch	1/2 to 3	3-1/8 x 3-1/8	1032 DP1 BLK	1032 001 BLK	10
White	Lock	1/2 to 3	3-1/8 x 3-1/8	1031 DP1 WHT	1031 001 WHT	10
White	Latch	1/2 to 3	3-1/8 x 3-1/8	1032 DP1 WHT	1032 001 WHT	10

FLUSH HATCH DOG, LOCK & LATCH COVER & TRIM RINGS

FIG. 777 - FLUSH HATCH DOG

**CHROME PLATED BRASS
STAINLESS STEEL LOCK NUTS
WITH FLUSH STRIKE**

For Securely "Dogging" (Fastening) Deck Hatches.

ORDERING INFORMATION

For Maximum Hatch Thickness Inches	Adjustment Latch Bar Inches	Dimensions Face Plate Inches	Standard Pkg. - 1 Pc. OEM Pkg. - 5 Pcs.	Screw Size	Weight Ounces
2	1-1/4 to 2	3-13/16 x 3	777 000 CHR	8	14



FIG. 777

FIG. 1089 - LOCK & LATCH COVER

**BLACK OR WHITE
FIBER REINFORCED PLASTIC
HINGED, WATER RESISTANT**

**No. 1 - FITS FIGS. 931 AND 932
No. 3 - FITS FIGS. 1031 AND 1032**

ORDERING INFORMATION

Finish	Fits Fig. No.	Dimensions Overall Inches	Display Pkg. - 5 Cards 1 Pc. per Card	OEM Bulk Pkg. 25 Pcs.	Weight Ounces
Black	931/932	2-3/4 x 3-1/4	1089 DP1 BLK	1089 001 BLK	2
Black	1031/1032	3-1/4 x 3-3/4	1089 DP3 BLK	1089 003 BLK	3
White	931/932	2-3/4 x 3-1/4	1089 DP1 WHT	1089 001 WHT	2
White	1031/1032	3-1/4 x 3-3/4	1089 DP3 WHT	1089 003 WHT	3



FIG. 1089

FIGS. 1024 & 1025 - TRIM RINGS

**CHROME PLATED ZINC
DESIGNED FOR USE WITH FIGS. 931 AND 932**

FIG. 1024 - HAS GRIPPER TEETH ON THE UNDER SIDE FOR CARPETED SURFACES.

FIG. 1025 - HAS A FLAT UNDER SIDE FOR SMOOTH SURFACES.

ORDERING INFORMATION

For Surface	Dimensions Overall Inches	Standard Pkg. - 5 Pcs. OEM Pkg. - 25 Pcs.	Weight Ounces
Carpet	2-7/8 x 2-7/8	1024 000 CHR	2
Smooth	2-7/8 x 2-7/8	1025 000 CHR	2



FIG. 1024/1025 TRIM RING



FIG. 1024/1025 TRIM RING WITH FLUSH LOCK. FLUSH LOCK NOT INCLUDED.

LATCH SETS

DETERMINING THE BEVEL REQUIRED ON A LOCK OR LATCH.

WHEN STANDING OUTSIDE

IF THE DOOR OPENS AWAY FROM YOU, THEN YOU NEED A LOCK OR LATCH WITH A REGULAR BEVEL.

IF THE DOOR OPENS TOWARD YOU, THEN YOU NEED A LOCK OR LATCH WITH A REVERSE BEVEL.

DOOR OPENING INWARD.



Right Hand Door Showing Regular Bevel Lock With Interchangeable Knob and Lever.



Left Hand Door Showing Regular Bevel Lock With Non-Interchangeable Knob and Lever.

DOOR OPENING OUTWARD.

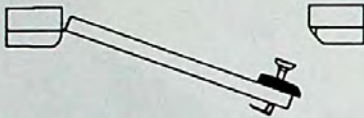

Right Hand Door Showing Reverse Bevel Lock With Interchangeable Knob and Lever.



Left Hand Door Showing Reverse Bevel Lock With Non-Interchangeable Knob and Lever.

ALL PERKO LOCK AND LATCH SETS MAY BE USED ON EITHER RIGHT OR LEFT HAND DOORS.



FIG. 567 - TUBULAR LATCH SET

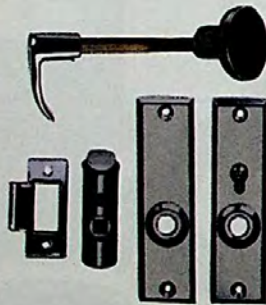

Fig. 567

CHROME PLATED ZINC

SLIDING LOCK BUTTON

ORDERING INFORMATION

For Door Thickness Inches	Dimensions Escutcheon Inches	O.D. Tube Inches	Display Pkg. - 5 Cards 1 Set per Card	OEM Bulk Pkg. 10 Sets	Screw Size	Weight Pounds
1 to 1-3/8	4-3/8 x 1-1/4	3/4	567 DP CHR	567 000 CHR	6	3/4

Spare Flush Strike, Cat. No. 912 000 CHR.

Spare Knob and Handle Assembly, Cat. No. 962 000 CHR.

CABINET & DOOR HARDWARE, LOCKS & LATCHES, HINGES AND HOOKS

LATCH SETS

FIGS. 1239 & 1240 - FLUSH CUP RIM LATCH SETS

**CHROME PLATED ZINC
SLIDING LOCK BUTTON**

FIG. 1239 - REGULAR BEVEL WITH BOX STRIKE
FIG. 1240 - REVERSE BEVEL WITH FLUSH STRIKE

Supplied with Black Plastic Spacer For Surface Mounting.
For Door Thickness 5/8 to 1 Inch.

ORDERING INFORMATION

Bevel Type	Dimensions		Display Pkg. - 5 Sets 1 Set per Pkg.	OEM Bulk Pkg. 10 Sets	Weight Pounds
	Case Inches	O.D. Cup Inches			
Regular	2 x 2-1/4	2-1/4	1239 DP CHR	1239 000 CHR	1
Reverse	2 x 2-1/4	2-1/4	1240 DP CHR	1240 000 CHR	1

Case and Cup Both, Screw Size #8.

Spare Box Strike, Cat. No. 977 000 CHR.
Spare Flush Strike, Cat. No. 912 000 CHR.

Spare Regular Bevel with Cam, Cat. No. 984 000 CHR.
Spare Reverse Bevel with Cam, Cat. No. 920 000 CHR.

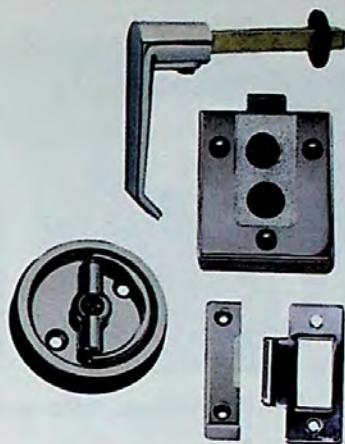

FIGS. 1239 & 1240

FIGS. 991 & 992 - MORTISE LATCH SETS

**CHROME PLATED ZINC
SLIDING LOCK BUTTON**

For Door Thickness 1/2 to 3/4 Inches.

FIG. 991 - REGULAR BEVEL WITH FLUSH STRIKE

FIG. 992 - REVERSE BEVEL WITH FLUSH STRIKE

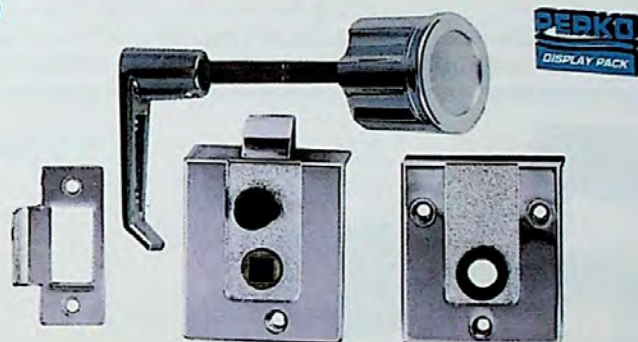

FIGS. 991 & 992

**EXPLODED
VIEW SHOWS
FIG. 992**

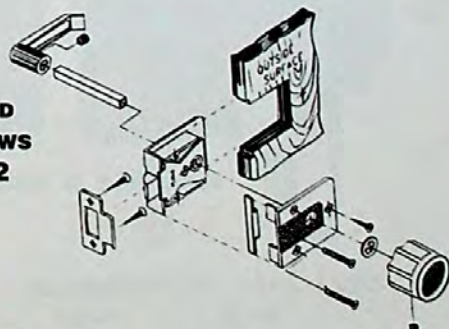

ORDERING INFORMATION

Bevel Type	Dimensions		Display Pkg. - 5 Sets 1 Set per Pkg.	OEM Bulk Pkg. 10 Sets	Screw Size	Weight Pounds
	Case Inches	Dimensions Escutcheon Inches				
Regular	1-5/8 x 1-5/8	2 x 2-1/4	991 DP CHR	991 000 CHR	6	1
Reverse	1-5/8 x 1-5/8	2 x 2-1/4	992 DP CHR	992 000 CHR	6	1

Spare Flush Strike, Cat. No. 912 000 CHR.
Spare Knob and Handle, Cat. No. 995 000 CHR.

Spare Regular Bevel with Cam, Cat. No. 984 000 CHR.
Spare Reverse Bevel with Cam, Cat. No. 920 000 CHR.

LATCH SETS

Figs. 929 & 1029 - RIM LATCH SET

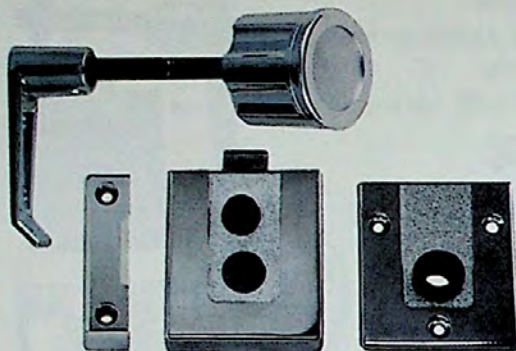

CHROME PLATED ZINC SLIDING LOCK BUTTON

For Door Thickness 1/2 to 1 Inch.

FIG. 929 - REGULAR BEVEL WITH BOX STRIKE
FIG. 1029 - REVERSE BEVEL WITH BOX STRIKE

Figs. 929 & 1029

ORDERING INFORMATION

Bevel Types	Dimensions Case Inches	Dimensions Escutcheon Inches	Display Pkg. - 5 Sets 1 Set per Card	OEM Bulk Pkg. 10 Sets	Screw Size	Weight Pounds
Regular	2 x 2-1/4	2 x 2-1/4	929 DP CHR	929 000 CHR	6	3/4
Reverse	2 x 2-1/4	2 x 2-1/4	1029 DP CHR	1029 000 CHR	6	3/4

Spare Box Strike, Cat. No. 977 000 CHR.

Spare Knob and Handle Assembly, Cat. No. 995 000 CHR.

Spare Regular Bevel with Cam, Cat. No. 984 000 CHR.

Spare Reverse Bevel with Cam, Cat. No. 920 000 CHR.



Figs. 968 & 1068 - RIM LATCH SET

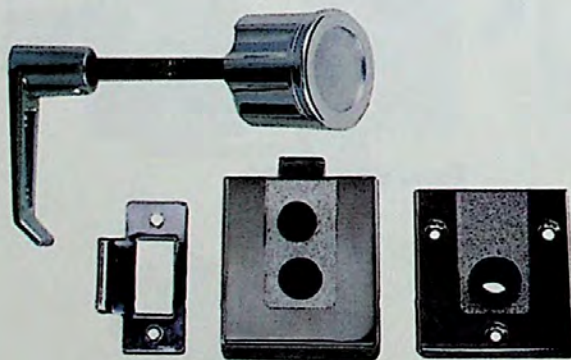

CHROME PLATED ZINC SLIDING LOCK BUTTON

For Door Thickness 1/2 to 1 Inch.

FIG. 968 - REGULAR BEVEL WITH FLUSH STRIKE
FIG. 1068 - REVERSE BEVEL WITH FLUSH STRIKE

Figs. 968 & 1068

ORDERING INFORMATION

Bevel Type	Dimensions Case Inches	Dimensions Escutcheon Inches	Display Pkg. - 5 Sets 1 Set per Card	OEM Bulk Pkg. 10 Sets	Screw Size	Weight Pounds
Regular	2 x 2-1/4	2 x 2-1/4	968 DP CHR	968 000 CHR	6	3/4
Reverse	2 x 2-1/4	2 x 2-1/4	1068 DP CHR	1068 000 CHR	6	3/4

Spare Flush Strike, Cat. No. 912 000 CHR.

Spare Knob and Handle Assembly, Cat. No. 995 000 CHR.

Spare Regular Bevel with Cam, Cat. No. 984 000 CHR.

Spare Reverse Bevel with Cam, Cat. No. 920 000 CHR.

LATCH & LOCK SETS

FIGS. 918 & 919 - RIM LOCK SET



CHROME PLATED ZINC

For Door Thickness 5/8 to 1-3/8 Inches.

- FIG. 918 - REGULAR BEVEL WITH BOX STRIKE**
FIG. 919 - REVERSE BEVEL WITH FLUSH STRIKE

Locks by Turn Button from Inside or Key from Outside

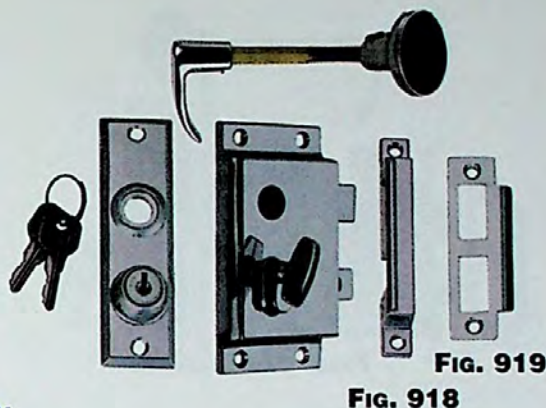

ORDERING INFORMATION

Bevel/Strike Type	Door Case Inches	Dimensions Escutcheon Inches	Dimensions Display Pkg. - 5 Sets 1 Set per Card	OEM Bulk Pkg. 10 Sets	Screw Size	Weight Pounds
Regular w/Box	3-7/8 x 2	4-3/8 x 1-1/4	918 DP CHR	918 000 CHR	6	1-1/4
Reverse w/Flush	3-7/8 x 2	4-3/8 x 1-1/4	919 DP CHR	919 000 CHR	6	1-1/4

Spare Box Strike, Cat. No. 918 000 99A.

Spare Flush Strike, Cat. No. 913 000 CHR.

Spare Knob and Handle Assembly, Cat. No. 962 000 CHR.

Spare Bevel with Cam for Both, Cat. No. 920 000 CHR.

Spare Escutcheon Plate with Keys, Cat. No. 953 000 CHR.

FIGS. 1279 & 1280 - FLUSH CUP RIM LATCH SET



CHROME PLATED ZINC SLIDING LOCK BUTTON

For Door Thickness 3/4 to 1-1/8 Inches.

- FIG. 1279 - REGULAR BEVEL WITH BOX STRIKE**
FIG. 1280 - REVERSE BEVEL WITH FLUSH STRIKE

Supplied with Black Plastic Spacer for Surface Mounting

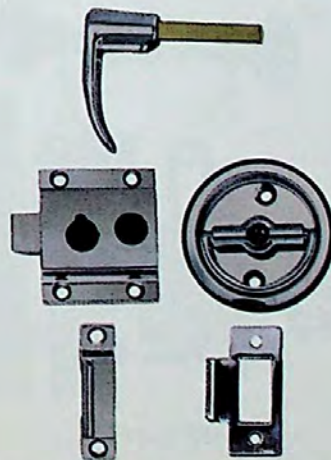

ORDERING INFORMATION

FIG. 1279 **FIG. 1280**

Bevel/Strike Type	Dimensions Case Inches	O.D. Cup Inches	Display Pkg. - 5 Sets 1 Set per Card	OEM Bulk Pkg. 10 Sets	Weight Pounds
Regular w/Box	2-1/8 x 1-3/4	2 x 2-1/4	1279 DP CHR	1279 000 CHR	1
Reverse w/Flush	2-1/8 x 1-3/4	2 x 2-1/4	1280 DP CHR	1280 000 CHR	1

Case Screw Size #6

Spare Box Strike, Cat. No. 976 000 CHR.

Spare Flush Strike, Cat. No. 912 000 CHR.

Cup Screw Size #8

Spare Regular Bevel with Cam, Cat. No. 984 000 CHR.

Spare Reverse Bevel with Cam, Cat. No. 920 000 CHR.

LATCH SETS

Figs. 928 & 1028 - RIM LATCH SET

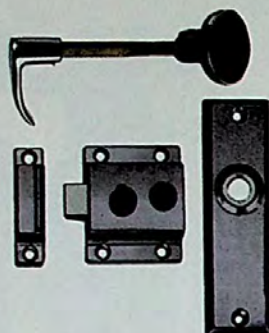

Figs. 928 & 1028

CHROME PLATED ZINC SLIDING LOCK BUTTON

For Door Thickness 5/8 to 1-3/8 Inches.

FIG. 928 - REGULAR BEVEL WITH BOX STRIKE
FIG. 1028 - REVERSE BEVEL WITH BOX STRIKE

ORDERING INFORMATION

Bevel Type	Dimensions Case Inches	Dimensions Escutcheon Inches	Display Pkg. - 5 Sets 1 Set per Card	OEM Bulk Pkg. 10 Sets	Screw Size	Weight Pounds
Regular	2-1/8 x 1-3/4	4-3/8 x 1-1/4	928 DP CHR	928 000 CHR	6	3/4
Reverse	2-1/8 x 1-3/4	4-3/8 x 1-1/4	1028 DP CHR	1028 000 CHR	6	3/4

Spare Box Strike, Cat. No. 976 000 CHR.

Spare Knob and Handle Assembly, Cat. No. 962 000 CHR.

Spare Regular Bevel with Cam, Cat. No. 984 000 CHR.

Spare Reverse Bevel with Cam, Cat. No. 920 000 CHR.



Figs. 930 & 1030 - RIM LATCH SET

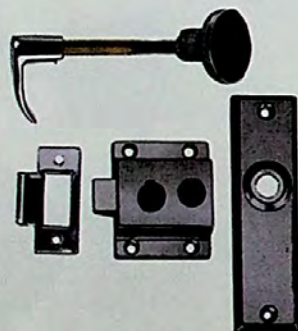

Figs. 930 & 1030

CHROME PLATED ZINC SLIDING LOCK BUTTON

For Door Thickness 5/8 to 1-3/8 Inches.

FIG. 930 - REVERSE BEVEL WITH FLUSH STRIKE
FIG. 1030 - REGULAR BEVEL WITH FLUSH STRIKE

ORDERING INFORMATION

Bevel Type	Dimensions Case Inches	Dimensions Escutcheon Inches	Display Pkg. - 5 Sets 1 Set per Card	OEM Bulk Pkg. 10 Sets	Screw Size	Weight Pounds
Reverse	2-1/8 x 1-3/4	4-3/8 x 1-1/4	930 DP CHR	930 000 CHR	6	3/4
Regular	2-1/8 x 1-3/4	4-3/8 x 1-1/4	1030 DP CHR	1030 000 CHR	6	3/4

Spare Flush Strike, Cat. No. 912 000 CHR.

Spare Knob and Handle Assembly, Cat. No. 962 000 CHR.

Spare Regular Bevel with Cam, Cat. No. 984 000 CHR.

Spare Reverse Bevel with Cam, Cat. No. 920 000 CHR.

LATCH & LOCK SETS

FIG. 927 - MORTISE LOCK SET



CHROME PLATED ZINC

Locked by Turn Button from Inside or Key from Outside.
Bevel can be Reversed During Installation.

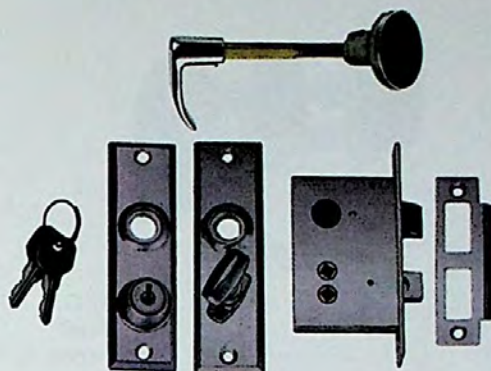

Fig. 927

ORDERING INFORMATION

For Door Thickness Inches	Dimensions Case Inches	Dimensions Escutcheon Inches	Display Pkg. - 5 Sets 1 Set per Sard	OEM Bulk Pkg. 10 Sets	Screw Size	Weight Pounds
1 to 1-3/8	2-3/4 x 2	4-3/8 x 1-1/4	927 DP CHR	927 000 CHR	6	1-1/4

Spare Flush Strike, Cat. No. 913 000 CHR.

Spare Bevel with Cam, Cat. No. 920 000 CHR.

Spare Knob and Handle Assembly, Cat. No. 962 000 CHR.

Spare Escutcheon Plate with Keys, Cat. No. 927 000 99B.

FIG. 960 - MORTISE LATCH SET



**CHROME PLATED ZINC
TURN BUTTON LOCK**

Bevel can be Reversed During Installation.

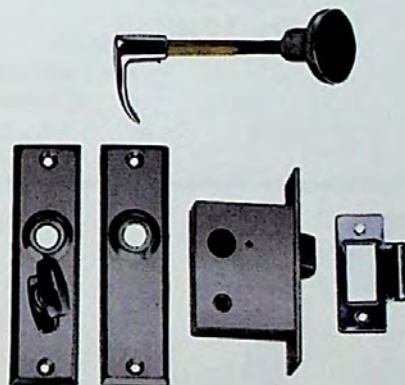

Fig. 960

ORDERING INFORMATION

For Door Thickness Inches	Dimensions Case Inches	Dimensions Escutcheon Inches	Display Pkg. - 5 Sets 1 Set per Card	OEM Bulk Pkg. 10 Sets	Screw Size	Weight Pounds
1 to 1-3/8	2-1/4 x 1-13/16	4-3/8 x 1-1/4	960 DP CHR	960 000 CHR	6	1

Spare Flush Strike, Cat. No. 912 000 CHR.

Spare Bevel with Cam, Cat. No. 960 000 99A.

Spare Knob and Handle Assembly, Cat. No. 962 000 CHR.

LATCH ASSEMBLY & ELBOW CATCHES



FIG. 938 - PULL AND LATCH ASSEMBLY

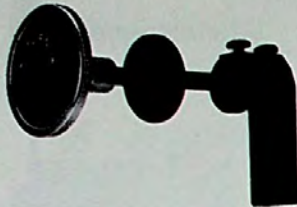

FIG. 938

**CHROME PLATED ZINC
BLACK PLASTIC INSERT
BRASS STEM**

ORDERING INFORMATION

O.D. Knob Inches	Max. Panel Thickness Inches	Display Pkg. - 5 Cards 1 Pc. per Card	OEM Bulk Pkg. 50 Pcs.	Weight Ounces
1-1/2	1-1/8	938 DP CHR	938 000 CHR	2

Spare Cam Bar, Cat. No. 938 000 99A.



FIG. 1056 - ELBOW CATCH



FIG. 1056

**CHROME PLATED ZINC
STAINLESS STEEL SPRING**

ORDERING INFORMATION

Dimensions Inches	Display Pkg. - 10 Cards 1 Pc. per Card	OEM Bulk Pkg. 50 Pcs.	Screw Size	Weight Ounces
1-1/8 x 9/16	1056 DP CHR	1056 000 CHR	6	3/4



FIG. 1021 - ELBOW CATCH



FIG. 1021

**BLACK PLASTIC
INTEGRAL SPRING**

ORDERING INFORMATION

Dimensions Inches	Display Pkg. - 25 Cards 2 Pcs. per Card	OEM Bulk Pkg. 100 Pcs.	Screw Size	Weight Ounces
1-3/16 x 5/8	1021 DP BLK	1021 000 BLK	6	1/2



KNOBS & FLUSH RING CATCH

FIG. 925 - KNOB



**CHROME PLATED BRASS
STAINLESS STEEL SCREW**



FIG. 925

ORDERING INFORMATION

O.D. Knob Inches	Max. Panel Thickness Inches	Display Pkg. - 10 Cards 1 Pc. per Card	OEM Bulk Pkg. 50 Pcs.	Weight Ounces
1	1-1/8	925 DP CHR	925 000 CHR	1-1/2

FIG. 926 - KNOB



**CHROME PLATED ZINC
BLACK PLASTIC INSERT
STAINLESS STEEL SCREW**



FIG. 926

ORDERING INFORMATION

O.D. Knob Inches	Max. Panel Thickness Inches	Display Pkg. - 10 Cards 1 Pc. per Card	OEM Bulk Pkg. 100 Pcs.	Weight Ounces
1-1/8	1-1/8	926 DP0 CHR	926 000 CHR	3/4
1-1/2	1-1/8	926 DP1 CHR	926 001 CHR	1

FIG. 1051 - FLUSH RING CATCH



**CHROME PLATED ZINC
PHOSPHOR BRONZE SPRING**

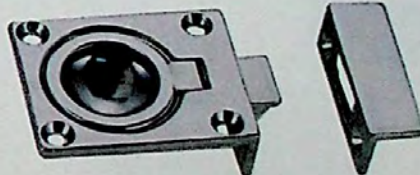

FIG. 1051

ORDERING INFORMATION

Dimensions Inches	Display Pkg. - 10 Cards 1 Pc. per Card	OEM Bulk Pkg. 25 Pcs.	Screw Size	Weight Ounces
2-1/4 x 1-3/8	1051 DP CHR	1051 000 CHR	6	1-1/2

FLUSH PULLS



Fig. 841

FIG. 841 - FLUSH RING PULL

CHROME PLATED ZINC

ORDERING INFORMATION

Dimensions Face Plate Inches	Display Pkg. - 10 Cards 1 Pc. per Card	OEM Bulk Pkg. 50 Pcs.	Screw Size	Weight Ounces
1-3/4 x 1-3/8	841 DP CHR	841 000 CHR	6	1



Fig. 1232

FIG. 1232 - FLUSH RING PULL

CHROME PLATED ZINC

ORDERING INFORMATION

O.D. Face Plate Inches	Display Pkg. - 5 Cards 1 Pc. per Card	OEM Bulk Pkg. 50 Pcs.	Screw Size	Weight Ounces
1-5/8	1232 DP1 CHR	1232 001 CHR	6	1
2	1232 DP2 CHR	1232 002 CHR	6	1-1/2

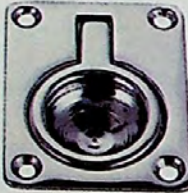

Fig. 1103

FIG. 1103 - FLUSH RING PULL

CHROME PLATED BRONZE

ORDERING INFORMATION

Dimensions Face Plate Inches	Display Pkg. - 5 Cards 1 Pc. per Card	OEM Bulk Pkg. 50 Pcs.	Screw Size	Weight Ounces
2-9/16 x 2	1103 DP CHR	1103 000 CHR	8	3-1/2



Fig. 575

FIG. 575 - FLUSH LIFTING PULL

CHROME PLATED BRONZE

ORDERING INFORMATION

Dimensions Face Plate Inches	Display Pkg. - 10 Cards 1 Pc. per Card	OEM Bulk Pkg. 50 Pcs.	Screw Size	Weight Ounces
2-5/8 x 2	575 DP CHR	575 000 CHR	8	3

PULLS & LIFTING HANDLES

FIG. 1221 - FLUSH PULL

**CHROME PLATED ZINC
BLACK PLASTIC FINISHING FLANGE**
Spring Loaded, Can be Mounted Horizontally or Vertically.

ORDERING INFORMATION

Dimensions Flange Inches	Display Pkg. - 5 Cards 1 Pc. per Card	OEM Bulk Pkg. 50 Pcs.	Screw Size	Weight Ounces
3/4 x 3-1/4	1221 DP CHR	1221 000 CHR	8	3

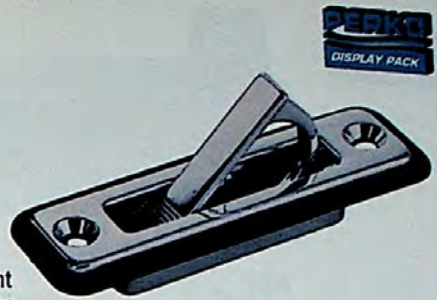

FIG. 1221

FIGS. 1286 & 1288 - RING PULLS

CHROME PLATED ZINC

FIG. 1286 - FOR SURFACE MOUNTING WITH BLACK PLASTIC SPACER
**FIG. 1288 - FOR FLUSH MOUNTING, EASILY INSTALLS
IN A 2 INCH DIAMETER HOLE**

ORDERING INFORMATION

Type of Mounting	O.D. Cup Inches	Display Pkg. - 5 Cards 1 Pc. per Card	Screw Size	Weight Ounces
Surface	2-1/4	1286 DP CHR	8	3-1/2
Flush	2-1/4	1288 DP CHR	8	3-1/2



FIG. 1286

FIG. 776 - FLUSH LIFTING HANDLE

CHROME PLATED BRONZE

Size No. 2 (Not Shown) Has All Mounting Holes at Corners

ORDERING INFORMATION

Dimensions Face Plate Inches	Dimensions Inside Handle Inches	Display Pkg. - 5 Cards 1 Pc. per Card	OEM Bulk Pkg. 25 Pcs.	Screw Size	Weight Ounces
3 x 2-1/4	1-7/8 x 1	776 DP1 CHR	776 001 CHR	8	3-1/2
3-3/4 x 2-3/4	2-3/16 x 1-3/16	776 DP2 CHR	776 002 CHR	8	5-1/2



FIG. 776

FIG. 1220 - FLUSH LIFTING HANDLE

CHROME PLATED ZINC

ORDERING INFORMATION

Dimensions Face Plate Inches	Dimensions Inside Handle Inches	Display Pkg. - 5 Cards 1 Pc. per Card	OEM Bulk Pkg. 50 Pcs.	Screw Size	Weight Ounces
3 x 2-1/4	1-7/8 x 1	1220 DP CHR	1220 000 CHR	8	3



FIG. 1220

FLUSH PULLS & SLIDING WINDOW HANDLE



FIG. 1110

FIG. 1110 - FLUSH PULL

CHROME PLATED ZINC

ORDERING INFORMATION

Dimensions Face Plate Inches	Depth Inches	Display Pkg. - 5 Cards 1 Pc. per Card	OEM Bulk Pkg. 50 Pcs.	Screw Size	Weight Ounces
3-11/16 x 1-11/16	7/16	1110 DP CHR	1110 000 CHR	6	3



FIG. 1016 BLACK

FIG. 1016 - FLUSH PULL

FIG. 1016 WHITE



BLACK OR WHITE PLASTIC
Easily Installs in a 1-3/4 Inch Diameter Hole

ORDERING INFORMATION

Color	Dimensions Face Plate Inches	Depth Inches	Display Pkg. - 10 Cards 1 Pc. per Card	OEM Bulk Pkg. 100 Pcs.	Screw Size	Weight Ounces
Black	2-1/4 x 2-1/4	15/16	1016 DP BLK	1016 000 BLK	6	1
White	2-1/4 x 2-1/4	15/16	1016 DP WHT	1016 000 WHT	6	1



FIG. 958

FIGS. 958 - PULL

CHROME PLATED ZINC

ORDERING INFORMATION

Width Overall Inches	Width Inside Inches	Display Pkg. - 10 Cards 1 Pc. per Card	Screw Size	Weight Ounces
3-7/16	2-5/16	958 DP CHR	6	1



FIG. 954

FIG. 954 - SLIDING WINDOW HANDLE

STAINLESS STEEL

ORDERING INFORMATION

For Glass Thickness Inches	Length Overall Inches	Display Pkg. - 5 Cards 1 Pc. per Card	Weight Ounces
1/4	3	954 DP STS	1

CABINET & DOOR HARDWARE, LOCKS & LATCHES, HINGES AND HOOKS

WINDOW STOPS, LOCKS & FASTENER

FIG. 935 - SLIDING WINDOW STOP

**CHROME PLATED ZINC
PLASTIC COVER ON STOPPING PLATE**

ORDERING INFORMATION

Dimensions Mounting Plate Inches	Length Stopping Plate Inches	Display Pkg. - 5 Cards 1 Pc. per Card	OEM Bulk Pkg. 50 Pcs.	Screw Size	Weight Ounces
1-7/8 x 3/4	1-1/2	935 DP CHR	935 000 CHR	8	2



FIG. 935

**FIG. 934 - SLIDING WINDOW LOCK & ANTI-RATTLER
FIG. 937 - SLIDING WINDOW LOCK & ANTI-RATTLER**

**CHROME PLATED ZINC
BLACK PLASTIC KNOB AND TIP**

ORDERING INFORMATION

Height Overall Inches	Dimensions Mounting Plate Inches	Adjustment Inches	Display Pkg. - 5 Cards 1 Pc. per Card	Screw Size	Weight Ounces
1	2 x 5/8	1-1/8	934 DP CHR	6	1-1/4
1-5/8	1 x 5/8	1-1/8	937 DP CHR	6	1-1/4



FIG. 937



FIG. 934

Spare Black Plastic Tip, Cat. No. 944

FIG. 148 - TABLE BRACKETS

**CHROME PLATED BRASS
For Removable Tables**

Supplied in Sets Consisting of Two Brackets and Two Wall Plates.

ORDERING INFORMATION

Dimensions Angle Bracket Inches	Dimensions Wall Plate Inches	Display Pkg. - 5 Cards 1 Set per Card	OEM Bulk Pkg. 25 Sets	Screw Size	Weight per Set Ounces
2-3/4 x 1-11/16	3-3/8 x 2	148 DP CHR	148 000 CHR	10	12

Spare Pair of Angle Brackets, Cat. No. 148 000 99A. Spare Pair of Wall Plates, Cat. No. 148 000 99B.



FIG. 148

FIG. 719 - FASTENER

**CHROME PLATED BRASS
BLACK PLASTIC KNOB WITH STAINLESS STEEL STUD**

ORDERING INFORMATION

Length Angle Inches	Width Angle Inches	Display Pkg. - 5 Cards 1 Pc. per Card	OEM Bulk Pkg. 25 Pcs.	Screw Size	Weight Ounces
1-3/8	1	719 DP CHR	719 000 CHR	8	3

Spare Knob, Cat. No. 719 000 99A
Spare Single Bracket, Cat. No. 719 000 99B
Spare Flat Plate, Cat. No. 719 000 99C



FIG. 719

UTILITY HOOKS



FIG. 1106 - UTILITY HOOK



FIG. 1106

CHROME PLATED ZINC

ORDERING INFORMATION

Projection Inches	Width Base Inches	Display Pkg. - 10 Cards 1 Pc. per Card	OEM Bulk Pkg. 50 Pcs.	Screw Size	Weight Ounces
3/4	1	1106 DP CHR	1106 000 CHR	6	3/4



FIG. 975 - UTILITY HOOK

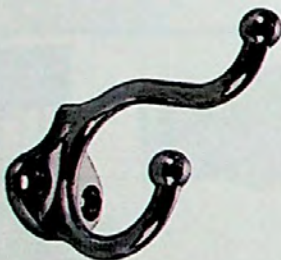

FIG. 975

CHROME PLATED ZINC

ORDERING INFORMATION

Projection Inches	Width Base Inches	Display Pkg. - 10 Cards 1 Pc. per Card	OEM Bulk Pkg. 50 Pcs.	Screw Size	Weight Ounces
2	1-1/8	975 DP1 CHR	975 001 CHR	6	1
3	1-1/4	975 DP2 CHR	975 002 CHR	6	1-1/2



FIG. 610 - UTILITY HOOK



FIG. 610

CHROME PLATED ZINC

ORDERING INFORMATION

Projection Inches	Width Base Inches	Display Pkg. - 10 Cards 1 Pc. per Card	OEM Bulk Pkg. 50 Pcs.	Screw Size	Weight Ounces
1-3/8	1-1/8	610 DP CHR	610 000 CHR	6	1/2

FASTENERS

Figs. 869, 896, 898, 901 & 907 - "DURABLE TYPE" FASTENERS

Figs. 896, 898, 901 & 907 - NICKEL PLATED BRASS
FIG. 869 - STAINLESS STEEL, 5/8 INCH SELF TAPPING SCREW.

For Canvas to Surface, Use Figs. 869, 896 and 898.
 For Canvas to Canvas, Use Figs. 896, 898, 901 & 907.

ORDERING INFORMATION

Description	Std. Pkg. - 100 Pcs. OEM Pkg. - 500 Pcs.
Stud	869 000 STS
Stud	901 000 NKL
Socket	898 000 NKL
Button	896 000 NKL
Eyelet	907 000 NKL



EYELET
FIG. 907



SOCKET
FIG. 898



BUTTON
FIG. 896



STUD
FIG. 901



STUD
FIG. 869



Figs. 60, 62, 116, 117 & 118 - "LIFT TYPE" FASTENERS

Figs. 60, 62, 116 & 118 - NICKEL PLATED BRASS
FIG. 117 - STAINLESS STEEL, 1/2 INCH SELF TAPPING SCREW.

ORDERING INFORMATION

Description	Standard Pkg. - 100 Pcs.
Clinch Stud	60 000 NKL
Clinch Washer	62 000 NKL
Clinch Plate	118 000 NKL
Stud	*117 000 STS
Socket	116 000 NKL

*OEM Pkg. - 500 pcs.



SOCKET
FIG. 116



CLINCH WASHER
FIG. 62



CLINCH PLATE
FIG. 118



CLINCH STUD
FIG. 60



STUD
FIG. 117



Figs. 994, 996 & 997 - CURTAIN FASTENERS

NICKEL PLATED BRASS

ORDERING INFORMATION

Description	Standard Pkg. - 100 Pcs.
Flanged Stud	994 000 NKL
Eyelet	996 000 NKL
Washer	997 000 NKL



WASHER
FIG. 997



EYELET
FIG. 996



FLANGED STUD
FIG. 994



CONVERTIBLE TOP FITTINGS, UTILITY HOOK & BOAT COVER SOCKETS



SOCKET
Fig. 395#3



SLIDE
Figs. 395#6 & 395 #S



SIDE PLATE
Fig. 395#8



HINGE
Fig. 395#1 & 395 #H



EYE END
Figs. 395#5 & 395#9

FIG. 395 - CONVERTIBLE TOP FITTINGS

**CHROME PLATED ZINC
STAINLESS STEEL SCREWS**

ORDERING INFORMATION

Description	Display Pkg. - 5 Cards 2 Pcs. per Card	OEM Bulk Pkg. 100 Pcs.	Screw Size	Average Weight Ounces
Hinge for 3/4" fittings	395 DP1 CHR	395 001 CHR	8	2
Socket for 3/4" tubing	395 DP3 CHR	395 003 CHR	---	2
Eye End for 3/4" tubing with .049" wall	395 DP5 CHR	*395 005 CHR	---	2
Slide for 3/4" tubing	395 DP6 CHR	395 006 CHR	---	2
Side Mounting Plate	395 DP8 CHR	395 008 CHR	10	2
Eye End for 7/8" tubing	395 DP9 CHR	395 009 CHR	---	2
Slide for 7/8" tubing	395 DPS CHR	**395 010 CHR	---	2
Hinge for 7/8" fittings	395 DPH CHR	**395 011 CHR	8	2



*OEM Bulk Pkg. - 200 pcs.
**OEM Bulk Pkg. - 50 pcs.



FIG. 1249 - UTILITY HOOK

CHROME PLATED ZINC

ORDERING INFORMATION



Fig. 1249

Length Overall Inches	Width Overall Inches	Inside Hook Inches	Display Pkg. - 10 Cards 5 Pcs. per Card	OEM Bulk Pkg. 100 Pcs.	Screw Size	Weight Ounces
15/16	1/2	1/4	1249 DP CHR	1249 000 CHR	6	1/2



FIG. 578 - BOAT COVER SOCKETS

CHROME PLATED ZINC

**Will Accommodate 3/8 Inch Wood or Plastic Battens
Up To 1-3/4 Inches Wide.**

ORDERING INFORMATION

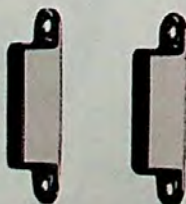

Fig. 578

Length Overall Inches	Dimensions Opening Inches	Width Overall Inches	Display Pkg. - 10 Cards 1 Pair per Card	Screw Size	Weight per Pair Ounces
3-1/4	1-7/8 x 7/16	5/8	578 DP CHR	6	1/2



OUTRIGGER POLE HOLDERS

FIG. 425 - FLYING BRIDGE RELEASE OUTRIGGER POLE HOLDERS

**STAINLESS STEEL MAIN TUBE AND SUPPORT ARMS
CHROME PLATED BRONZE FITTINGS.**

An adjustable length, hinged support arm allows the pole holder to be raised and lowered remotely with the use of a line running through an eye on the hinge and attached to the integral eye on the upper stop collar (Fig. No. 409). The main tube and both support arms have heavy swivel mounting bases for versatility of installation and use. Large knobs on the sliding clamps provide ready adjustment for all fishing positions. Stainless steel drift pins on both sliding clamps are pulled to release the pole holder to the down and aft position. Sturdy folding lay down hooks (Fig. No. 410) are included for supporting the outriggers in the down position. Also included are second stop collar (Fig. No. 415) for presetting the desired fishing angle, and a flying bridge holding bracket (Fig. No. 423) with a heavy swivel mounting base and hinge for quick release.

ORDERING INFORMATION

"A" Length Main Tube Feet	Standard Pkg. - 1 Pair	"B" Length Upper Arm Inches	"C" Length Lower Arm Inches	Weight per Pair Pounds
4	425 004 CHR	23 - 33	41-7/8	65
6	425 006 CHR	35 - 45	50-3/8	75
8	425 008 CHR	46 - 56	74-1/2	95

For Use With Outriggers Cat. Nos. 1798 019 ALU, 1798 019 BLK, 1798 022 ALU, 1798 022 BLK, 1798 025 ALU AND 1798 025 BLK.

Main Tube O.D. - 2".
Mounting Flanges O.D. - 4".

Main Tube I.D. - 1.900".
Bolt Size - 1/4".

SPARE PARTS ORDERING INFORMATION

Spare Lower Stop Collar, Cat. No. 415 002 CHR.
Spare Upper Stop Collar with Integral Eye, Cat. No. 409 000 CHR.
Spare Lay Down Hook, Cat. No. 410 002 CHR.
Spare Knob for Sliding Clamp Assembly, Cat. No. 401 000 CHR.
Spare Holding Bracket, Cat. No. 423 000 CHR.



FIG. 400 - OUTRIGGER POLE HOLDERS

A large knob on the sliding clamps provide ready adjustment for all fishing positions. All joints swivel for easy installation and use. A stop collar, with an integral eye for the lifting line, is included for presetting the desired fishing angle. Sturdy folding lay down hooks (Fig. No. 410) are also included for supporting the outriggers in the down position. The upper holding bracket (Fig. No. 408) is hinged for quick release.

ORDERING INFORMATION

"A" Length Main Tube Feet	Standard Pkg. - 1 Pair	"B" Length Upper Arm Inches	"C" Length Lower Arm Inches	Weight per Pair Pounds
4	400 004 CHR	27-1/4	41-7/8	59
6	400 006 CHR	38-7/8	50-3/8	70
8	400 008 CHR	50-3/8	74-1/2	90

For Use With Outriggers Cat. Nos. 1798 019 ALU, 1798 019 BLK, 1798 022 ALU, 1798 022 BLK, 1798 025 ALU AND 1798 025 BLK.

Main Tube O.D. - 2".
Mounting Flanges O.D. - 4".

Main Tube I.D. - 1.900".
Bolt Size - 1/4".

SPARE PARTS ORDERING INFORMATION

Spare Stop Collar, Cat. No. 409 000 CHR.
Spare Lay Down Hook, Cat. No. 410 002 CHR.
Spare Knob for Sliding Clamp Assembly, Cat. No. 401 000 CHR.
Spare Holding Bracket, Cat. No. 408 000 CHR.

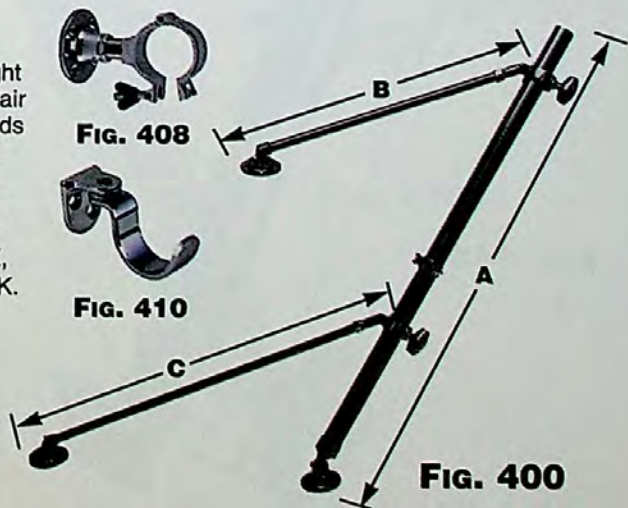

FISHING EQUIPMENT

OUTRIGGER POLE HOLDERS

FIG. 445 - OUTRIGGER POLE HOLDERS

**STAINLESS STEEL MAIN TUBE
CHROME PLATED BRASS YOKE TUBING AND BRONZE FITTINGS.**

A large knob on the sliding clamp provides ready adjustment for all fishing positions. A stainless steel drift pin in the sliding clamp is pulled to release the pole holder to a down and aft position. Features include heavy bi-directional hinged mounting base for easy installation on a horizontal or vertical surface. A stop collar (Fig. No. 415) is included for presetting the desired fishing angle. Sturdy folding lay down hooks (Fig. No. 410) are also included for supporting the outriggers in the down position. The mounting yokes may be installed in an inverted position, rather than that shown, to accommodate various installation requirements.

ORDERING INFORMATION

Holder Size No.	I.D. Main Tube Inches	"A" Length Main Tube Inches	O.D. Main Tube Inches	Standard Pkg. - 1 Pair	"B" Yoke Width Inches	Weight Per Pair Pounds	Bolt Size Inches
1	1.500	20	1-5/8	445 001 CHR	11-3/4	22	1/4
2	1.900	20	2	445 002 CHR	11-3/4	24	1/4
3	1.900	35	2	445 003 CHR	24	33	1/4

Size No. 1 For Use With Outrigger Poles Cat. Nos. 1798 016 ALU, 1798 016 BLK, 1798 018 ALU and 1798 018 BLK.

Size No. 2 For Use With Outrigger Poles Cat. Nos. 1798 019 ALU and 1798 019 BLK.

Size No. 3 For Use With Outrigger Poles Cat. Nos. 1798 019 ALU, 1798 019 BLK, 1798 022 ALU, 1798 022 BLK, 1798 025 ALU and 1798 025 BLK.



FIG. 445

Sizes 1 and 2 feature a retaining bar on one mounting bracket (as illustrated) to hold the outrigger in the vertical position.

Size 3 features a standard hinge holding bracket (Fig. No. 408) for quick release of the main tube.



FIG. 410



FIG. 415

SPARE PARTS ORDERING INFORMATION

Spare Stop Collar Only for Size 1 Holder, Cat. No. 415 001 CHR.

Spare Stop Collar for Size 2 and 3 Holders, Cat. No. 415 002 CHR.

Spare Lay Down Hook for Size 1 Holder, Cat. No. 410 001 CHR.

Spare Lay Down Hook for Size 2 and 3 Holders, Cat. No. 410 002 CHR.

Spare Locking Bar Assembly with Stud, Cat. No. 406 000 99A.

Spare Knob for Sliding Clamp Assembly, Cat. No. 401 000 CHR.

OUTRIGGER POLE HOLDERS

FIG. 470 - OUTRIGGER POLE HOLDERS

**STAINLESS STEEL MAIN TUBE
CHROME PLATED BRASS YOKE TUBING AND BRONZE FITTINGS.**

A large knob on the sliding clamp provides ready adjustment for all fishing positions. A stainless steel drift pin in the sliding clamp is pulled to release the pole holder to a down and aft position. Features include a heavy swivel mounting base for easy installation on a horizontal or vertical surface. A stop collar (Fig. No. 415) is included for presetting the desired fishing angle. Sturdy folding lay down hooks (Fig. No. 410) are also included for supporting the outriggers in the down position. The mounting yokes may be installed in an inverted position, rather than that shown, to accommodate various installation requirements.

ORDERING INFORMATION

Holder Size No.	I.D. Main Tube Inches	"A" Length Main Tube Inches	O.D. Main Tube Inches	Standard Pkg. - 1 Pair	"B" Yoke Width Inches	Weight Per Pair Pounds	Bolt Size Inches
1	1.500	20	1-5/8	470 001 CHR	11-3/4	22	1/4
2	1.900	20	2	470 002 CHR	11-3/4	24	1/4
3	1.900	35	2	470 003 CHR	24	33	1/4

Size No. 1 For Use With Outrigger Poles Cat. Nos. 1798 016 ALU, 1798 016 BLK, 1798 018 ALU and 1798 018 BLK.

Size No. 2 For Use With Outrigger Poles Cat. Nos. 1798 019 ALU and 1798 019 BLK.

Size No. 3 For Use With Outrigger Poles Cat. Nos. 1798 019 ALU, 1798 019 BLK, 1798 022 ALU, 1798 022 BLK, 1798 025 ALU and 1798 025 BLK.

Sizes 1 and 2 feature a retaining bar on one mounting bracket (as illustrated) to hold the outrigger in the vertical position.

Size 3 features a standard hinge holding bracket (Fig. No. 408) for quick release of the main tube.



FIG. 410



FIG. 415



FIG. 470

SPARE PARTS ORDERING INFORMATION

- Spare Stop Collar Only for Size 1 Holder, Cat. No. 415 001 CHR.
- Spare Stop Collar for Size 2 and 3 Holders, Cat. No. 415 002 CHR.
- Spare Lay Down Hook for Size 1 Holder, Cat. No. 410 001 CHR.
- Spare Lay Down Hook for Size 2 and 3 Holders, Cat. No. 410 002 CHR.
- Spare Locking Bar Assembly with Stud, Cat. No. 406 000 99A.
- Spare Knob for Sliding Clamp Assembly, Cat. No. 401 000 CHR.

OUTRIGGER POLE HOLDERS

**REMOVABLE TUBES LIFT AND TURN TO THREE POSITIONS: VERTICAL, FISHING AND LOWERED.
UNIVERSAL TUBES MAY BE USED ON EITHER SIDE.
SUPPLIED IN PAIRS CONSISTING OF TWO MOUNTS AND TWO TUBES.**



Fig. 444

FIG. 444 - OUTRIGGER POLE HOLDERS

SIDE MOUNT

Chrome Plated Bronze Brackets
Size 1 Tubes are Polished Stainless Steel.
Size 2 Tubes are Chrome Plated Brass.

ORDERING INFORMATION

Holder Size No.	I.D. Tube Inches	O.D. Tube Inches	Dimensions Bracket Inches	Display Pkg. - 5 Pkgs. 1 Pair per Pkg.	Standard Pkg. - 1 Pair	Weight per Pair Pounds
1	1.120	1-1/4	4-1/2 x 3	444 DP1 CHR	-----	4-5/8
2	1.500	1-5/8	6-1/2 x 4	-----	444 002 CHR	8-1/4

Size 1 Bolt Size - 1/4". Size 2 Bolt Size - 5/16".
Spare Bracket For Size No. 1, Cat. No. 478 001 CHR. Spare Bracket For Size No. 2, Cat. No. 478 002 CHR.
See Fig. 451 for Outrigger Designations and Spare Tube Ordering.

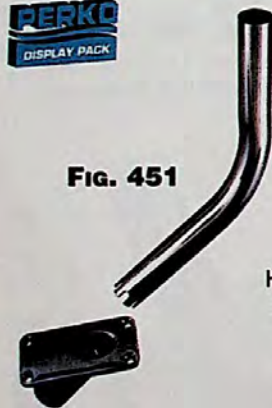

Fig. 451

FIG. 451 - OUTRIGGER POLE HOLDERS

DECK MOUNT

Chrome Plated Bronze Plates
Size 1 Tubes are Polished Stainless Steel.
Size 2 Tubes are Chrome Plated Brass.

ORDERING INFORMATION

Holder Size No.	I.D. Tube Inches	O.D. Tube Inches	Dimensions Bracket Inches	Display Pkg. - 5 Pkgs. 1 Pair per Pkg.	Standard Pkg. - 1 Pair	Weight per Pair Pounds
1	1.120	1-1/4	5 x 2-1/2	451 DP1 CHR	-----	6-5/8
2	1.500	1-5/8	6 x 3-1/2	-----	451 002 CHR	11-1/4

Size 1 Bolt Size - 1/4". Size 2 Bolt Size - 5/16".

Spare Tube Only For Figs. 444 & 451 Size 1, Cat. No. 479 DP1 STS. Spare Plate Only for Size No. 1, Cat. No. 474 001 CHR.
Spare Tube Only For Figs. 444 & 451 Size 2, Cat. No. 479 002 CHR. Spare Plate Only for Size No. 2, Cat. No. 474 002 CHR.

Size No. 1 For Use With Outrigger Poles Cat. Nos. 476 015 ALU, 1798 015 ALU and 1798 015 BLK.
Size No. 2 For Use With Outrigger Poles Cat. Nos. 1798 016 ALU, 1798 016 BLK, 1798 018 ALU and 1798 018 BLK.



Fig. 1314

FIG. 1314 - OUTRIGGER POLE HOLDERS

DECK MOUNT

Chrome Plated Zinc Plates.
Stainless Steel Tubes.
Improved For Use with Aluminum Outrigger Poles,
Cat. Nos. 1798 015 ALU and 476 015 ALU.

ORDERING INFORMATION

I.D. Tube Inches	O.D. Tube Inches	Dimensions Bracket Inches	Display Pkg. - 5 Pkgs. 1 Pair per Pkg.	OEM Bulk Pkg. 10 Pair	Bolt Size Inches	Weight per Pair Pounds
1.120	1-1/4	5 x 2-1/2	1314 DP CHR	1314 000 CHR	1/4	4-3/4

Spare Tube Only, Cat. No. 479 DP1 STS.

Spare Plate Only, Cat. No. 1320 000 CHR.

OUTRIGGER POLE KIT, LINE GUIDES & TROLLING PIN

FIG. 476 - 15' ALUMINUM OUTRIGGER POLE KIT

One Pair of Fig. No. 1798 015 Aluminum Poles, Guides and Clips Included.

For Use With Fig. Nos. 444 DP1 CHR, 451 DP1 CHR and 1314 DP CHR Holders.

ORDERING INFORMATION

Open Length Overall Feet	O.D. Base Inches	Number of Sections	Standard Pkg. 1 Kit per Box	Weight per Pair Pounds
15	1.120	4	476 015 ALU	6-3/4

Spare Pole Only, Cat. No. 1798 015 99A.

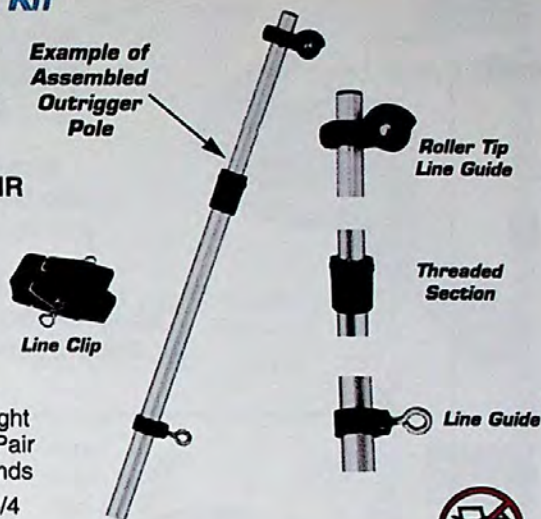

FIG. 476

FIG. 471 - OUTRIGGER POLE ROLLER TIP LINE GUIDES

HIGH IMPACT BLACK PLASTIC WITH 7/8 INCH O.D. NYLON SHEAVE

ORDERING INFORMATION

I.D. Body Inches	For Use With Outrigger Pole Size	Maximum Rope Size Inches	Display Pkg. - 5 Cards 1 Pair per Card	Weight per Pair Ounces
9/16	-----	1/4	471 DP1 BLK	1
5/8	1798 015	1/4	471 DP2 BLK	1
3/4	1798 016 thru 025	1/4	471 DP3 BLK	1



FIG. 471

FIG. 468 - OUTRIGGER POLE LINE GUIDES

HIGH IMPACT BLACK PLASTIC WITH 3/8 INCH I.D. STAINLESS STEEL EYE

ORDERING INFORMATION

I.D. Body Inches	Display Pkg. - 5 Cards 2 Pcs. per Card	Weight per Pair Ounces
9/16	468 DP1 BLK	3
5/8	468 DP2 BLK	3-1/2
3/4	468 DP3 BLK	3-1/2
1	468 DP4 BLK	3-1/2
1-3/16	468 DP5 BLK	4
1-5/8	468 DP6 BLK	4-1/2



FIG. 468

FIG. 469 - OUTRIGGER TROLLING PIN OR CLIP

HIGH IMPACT BLACK PLASTIC WITH STAINLESS STEEL EYES AND SPRING

ORDERING INFORMATION

Dimensions Inches	Display Pkg. - 5 Cards 2 Pcs. per Card	Weight Ounces
2-3/4 x 1-3/8	469 DP BLK	1-1/2



FIG. 469

OUTRIGGER POLES & SPREADERS

FIG. 1798 - OUTRIGGER POLES

**SILVER ANODIZED ALUMINUM
WITH BLACK PLASTIC INSULATED BASE**

Sizes 15 Through 19 Have Standard (Fig. No. 468) Line Guides, Sizes 22 and 25 Have Integral Line Guides and All Sizes Have Roller Tip (Fig. No. 471) Line Guides.

Heavy Duty Poles For Rough Water Use.
Sizes 15 Through 19 Have Sections Threaded For Easy Assembly,
Sizes 22 and 25 Have Sections Thru-Bolted For Extra Strength.

ORDERING INFORMATION

"A" Length Overall Feet	"B" Base Diameter Inches	Number Of Sections	Silver Standard Pkg. - 1 Pair Cat. No.	Silver Single Pole Only Cat. No.	Weight per Pair Pounds
15	1.120	4	1798 015 ALU	1798 015 99A	6-1/2
15	1.500	4	1798 016 ALU	1798 016 99A	8-1/4
18-2/3	1.500	5	1798 018 ALU	1798 018 99A	12-5/8
18-2/3	1.900	5	1798 019 ALU	1798 019 99A	12-3/4
22-1/4	1.900	6	1798 022 ALU	1798 022 99A	17-5/8
25-1/2	1.900	7	1798 025 ALU	1798 025 99A	24-5/8

FIGS. 1714 & 1715 - SPREADERS

**ANODIZED ALUMINUM
SPREADER ARMS AND EYE BANDS
SILVER OR GOLD FINISH.**

Designed For Use With Our Aluminum
Outrigger Poles When Maximum Rigidity is Desired.
Spreaders Are Suggested For Use On 18 and 19 Foot
Outrigger Poles and Recommended
For Use On 22 and 25 Foot Outrigger Poles.

Supplied in Pairs, Consisting of: Spreaders,
Stainless Steel Cable, Eye Bands and Turnbuckles.

ORDERING INFORMATION

For Use With Outrigger Poles Catalog Numbers	Silver Single Spreader Standard Pkg. - 1 Pair	Gold Single Spreader Standard Pkg. - 1 Pair	Silver Double Spreader Standard Pkg. - 1 Pair	Gold Double Spreader Standard Pkg. - 1 Pair
1798 018 ALU	1714 018	1714 018 GLD	-----	-----
1798 018 BLK	1714 018	1714 018 GLD	-----	-----
1798 019 ALU	1714 018	1714 018 GLD	-----	-----
1798 019 BLK	1714 018	1714 018 GLD	-----	-----
1798 022 ALU	1714 022	1714 022 GLD	1715 022	1715 022 GLD
1798 022 BLK	1714 022	1714 022 GLD	1715 022	1715 022 GLD
1798 025 ALU	-----	-----	1715 025	1715 025 GLD
1798 025 BLK	-----	-----	1715 025	1715 025 GLD

FISHING EQUIPMENT

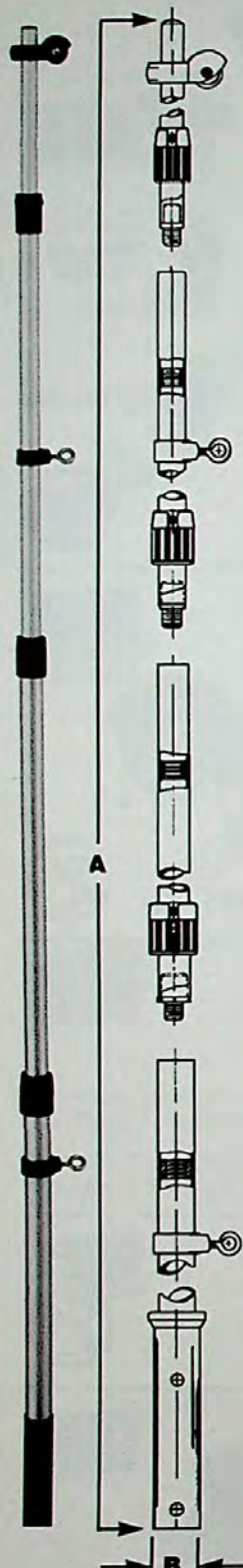

FIG. 1798

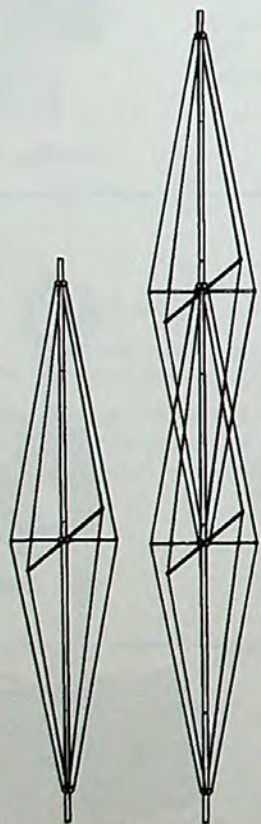

FIG. 1714 SINGLE **FIG. 1715 DOUBLE**

FISHING ROD HOLDERS

FIG. 1205 - FISHING ROD HOLDER

ANGLED FLUSH MOUNT

Chrome Plated Zinc Flange,
Anodized Aluminum Tube, Soft Black Liner and
Flange Gasket with Integral Flip-up Cap.



Fig. 1205



ORDERING INFORMATION

I.D. Tube Inches	O.D. Tube Inches	Length Under Flange Inches	Dimensions Flange Inches	Display Pkg. - 5 Pkgs. 1 Pc. per Pkg.	OEM Bulk Pkg. 20 Pcs.	Weight Pounds
1-5/8	2	8	4-1/4 x 3-1/2	1205 DP CHR	1205 000 CHR	1-1/2

Bolt Size 1/4".

FIGS. 447 & 448 - FISHING ROD HOLDERS

ANGLED & VERTICAL FLUSH MOUNTS

Chrome Plated Bronze Flange,
Chrome Plated Brass Tube.



Fig. 448-D01 ILLUSTRATED

Fig. 447 - Hard Black Plastic Liner with Integral Flip-up Cap.

Fig. 448 No. 1 - Soft Black Liner and Flange Gasket with Integral Flip-up Cap.

D01 - Includes a Drain Bib for 5/8 Inch I.D. Flexible Hose.

001 & DP1 Without Drain Bib.

Fig. 448 No. 2 - Soft Black Liner with Lip Only.



ORDERING INFORMATION

Mount Type	Drain Bib	I.D. Tube Inches	O.D. Tube Inches	Length Under Flange Inches	Dimensions Flange Inches	Display Pkg. 5 Pkgs. 1 Pc. per Pkg.	OEM Bulk Pkg. 10 Pcs.	Bolt Size	Weight Pounds
Vertical	No	1-5/8	2	9	3-1/2 O.D.	447 DP1 CHR	447 001 CHR	10	1-1/4
Angled	No	1-5/8	2	8	4-1/4 x 3-1/2	448 DP1 CHR	448 001 CHR	1/4	2
Angled	Yes	1-5/8	2	9-1/2	4-1/4 x 3-1/2	-----	448 D01 CHR	1/4	2
Angled	No	1-7/8	2-1/4	12	4-7/8 x 4	*448 DP2 CHR	-----	1/4	3-3/8

*Display Pkg. - 1 card, 1 Pc. per card.

Fig. 447

FIG. 452 - FISHING ROD HOLDER

ANGLED FLUSH MOUNT

Polished Stainless Steel Flange,
Stainless Steel Tube, Soft Black Liner and
Flange Gasket with Integral Flip-up Cap.

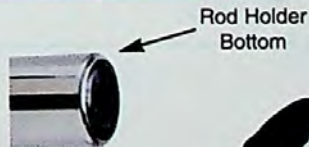

Fig. 452



ORDERING INFORMATION

I.D. Tube Inches	O.D. Tube Inches	Length Under Flange Inches	Dimensions Flange Inches	Display Pkg. - 5 Pkgs. 1 Pc. per Pkg.	OEM Bulk Pkg. 20 Pcs.	Weight Pounds
1-5/8	2	8-1/4	4-1/8 x 3-3/8	452 DP STS	452 000 STS	1-3/8

Bolt Size #10.

SPARE PARTS ORDERING INFORMATION

Spare Liner with Lip and Tube, See Fig. 482 DP, Specify Size, Page 192.
Spare Cap and Gasket Kit, See Figs. 480 DP and 481 DP, Specify Size, Page 192.

FISHING ROD HOLDERS

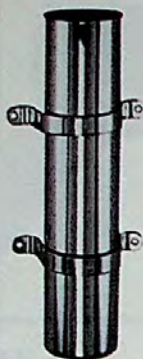
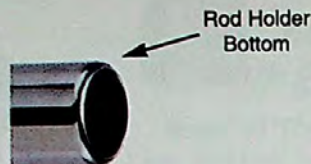

Fig. 1100



Rod Holder Bottom

Fig. 1100 - FISHING ROD HOLDER

SIDE MOUNT

Chrome Plated Brass
with Hard Black Plastic Liner.

ORDERING INFORMATION

I.D. Tube Inches	O.D. Tube Inches	Length Overall Inches	Width Bracket Inches	Display Pkg. - 5 Pkgs. 1 Pc. per Pkg.	Weight Pounds
1-5/8	2	9	3	1100 DP CHR	1-1/4

Bolt Size #8 R.H.

Spare Bracket, Cat. No. 1107 000 CHR.

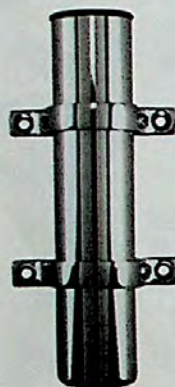

Fig. 404 #1

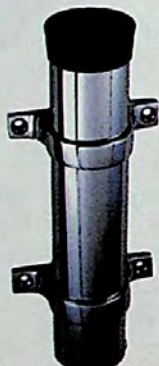
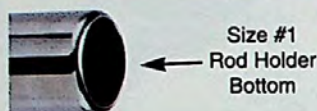

Fig. 404 #2



Size #1 Rod Holder Bottom

Fig. 404 - HEAVY DUTY FISHING ROD HOLDER

SIDE MOUNT

Chrome Plated Brass and Bronze.
Size #1 with Hard Black Plastic Liner.
Size #2 Soft Black Lip & Liner.

ORDERING INFORMATION

I.D. Tube Inches	O.D. Tube Inches	Length Overall Inches	Width Bracket Inches	Display Pkg. - 5 Pkgs. 1 Pc. per Pkg.	Weight Pounds
1-5/8	2	9	4-3/16	404 DP1 CHR	2
1-7/8	2-1/4	11	4-3/4	*404 DP2 CHR	3-1/8

Bolt Size 1/4".

* Display Pkg. - 1 card, 1 Pc. per card.

Spare Bracket for Size No. 1, Cat. No. 404 001 99A.

Spare Bracket for Size No. 2, Cat. No. 404 002 99A.

Spare Liner with Lip and Tube for Size #2 See Fig. 483 DP2 BLK on Page 192.



Fig. 1104

Fig. 1104 - FISHING ROD HOLDER

SIDE MOUNT

Black Plastic
With Chrome Plated Brass Brackets.

ORDERING INFORMATION

I.D. Tube Inches	O.D. Tube Inches	Length Overall Inches	Width Bracket Inches	Display Pkg. - 5 Pkgs. 1 Pc. per Pkg.	Weight Pounds
1-5/8	2	9	3-1/4	1104 DP BLK	5/8

Bolt Size #8 R.H.

Spare Bracket, Cat. No. 1107 000 CHR.

FISHING ROD HOLDERS

FIG. 1118 - FISHING ROD HOLDER

CLAMP ON

Chrome Plated Brass and Bronze with Hard Black Plastic Liner.

Clamp-On Feature Eliminates Drilling Rail and Simplifies Relocation.

Mounts on Vertical or Horizontal Rails.

Adjustable For Rails 7/8 to 1 Inch in Diameter
and by Reducing Mounting Bolt Length, 3/4 Inch Diameter Rails.

ORDERING INFORMATION

I.D. Tube Inches	O.D. Tube Inches	Length Overall Inches	Standard Pkg. 5 Pcs.	Weight Pounds
1-5/8	2	9	1118 DP CHR	2-1/4

Spare Face Plate with Bolts, Cat. No. 1118 000 99A.

Spare Intermediate Plate, Cat. No. 1118 000 99B.

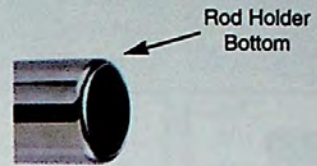

FIG. 1118

FIG. 1215 - FISHING ROD HOLDER

CLAMP ON

Chrome Plated Zinc with Polished Stainless Steel Tube
Hard Black Plastic Liner

Clamp-On Feature Eliminates Drilling Rail and Simplifies Relocation.

Mounts on Vertical or Horizontal Rails.

Adjustable For Rails 7/8 to 1 Inch in Diameter
and by Reducing Mounting Bolt Length, 3/4 Inch Diameter Rails.

ORDERING INFORMATION

I.D. Tube Inches	O.D. Tube Inches	Length Overall Inches	Standard Pkg. - 1 Pc.	Weight Pounds
1-5/8	2	9	1215 DP CHR	2

Spare Face Plate with Bolts, Cat. No. 1215 000 99A.

Spare Intermediate Plate, Cat. No. 1215 000 99B.

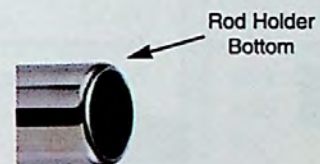

FIG. 1215



FISHING ROD HOLDER, CAP & GASKET KITS AND LINERS, LIPS & TUBES



FIG. 449 - FISHING ROD HOLDER

REMOVABLE

Chrome Plated Brass and Manganese Bronze
With Soft Black Liner.

Designed for Vertical Mounting, This Holder is Easily Removed
When Not in Use, Leaving No Projecting Hardware.

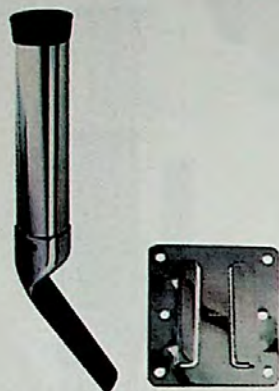

Fig. 449

ORDERING INFORMATION

I.D. Tube Inches	O.D. Tube Inches	Dimensions Bracket Inches	Display Pkg. - 1 Card 1 Pc. per Card	Weight Pounds
1-5/8	2	4 x 3-3/4	449 DP CHR	2-1/4

Screw Size #10.

Spare Holder Only, Cat. No. 449 000 99A.

Spare Bracket Only, Cat. No. 449 000 99B.

Spare Liner with Lip and Tube, Cat. No. 483 DP1 BLK.



FIGS. 480 & 481 - CAP AND GASKET KITS

REMOVABLE

Soft Black Flange Gasket with Integral Flip-up Cap and Soft Black Lip.
Replacement or Upgrade for Older Holders.



Fig. 480

ORDERING INFORMATION

To Fit Catalog Number	Display Pkg. - 5 Cards 1 Kit per Card	Weight Ounces
448 DP1 CHR	480 DP BLK	3
1205 DP CHR	480 DP BLK	3
452 DP STS	481 DP BLK	3



FIGS. 482 & 483 - LINERS, LIPS AND TUBES

FOR FISHING ROD HOLDERS

Except Fig. Nos. 447, 1104 and 1215.



Fig. 482

Fig. 483

ORDERING INFORMATION

I.D. Inches	For Angled Flush Mount Complete Display Pkg. - 5 Cards 1 Set per Card	For All Others Complete Display Pkg. - 5 Cards 1 Set per Card	Spare Lip Only For Fig. 482 Display Pkg. - 5 Cards 1 Pc. per Card	Spare Lip Only For Fig. 483 Display Pkg. - 5 Cards 1 Pc. per Card
1-5/8	482 DP1 BLK	483 DP1 BLK	482 DP1 99A	483 DP1 99A
1-7/8	482 DP2 BLK	483 DP2 BLK	482 DP2 99A	483 DP2 99A



NUMERICAL INDEX

FIG. No.	PAGE No.	FIG. No.	PAGE No.	FIG. No.	PAGE No.	FIG. No.	PAGE No.	FIG. No.	PAGE No.
4D	38 & 49	122	154	226	25	301	109	400	183
4F	38 & 49	123	94	230	41	303	46 & 52	401	183 to 185
5D	38 & 49	124	114	233	141	305	54	403	50
5F	38 & 49	125	17 & 18	236	126	306	81	404	190
7D	38 & 49	126	101 & 102	237	126	307	116	406	184 & 185
7F	38 & 49	127	94	238	20 to 22	309	25 & 50	408	183
24	22,25, 36 & 41	131	38 & 49		& 24	310	80	409	183
42	85	132	70	240	15 to 18	313	54	410	183 to 185
52	41	133	51	241	5	315	89	411	116
60	181	134	48 & 51	244	69	318	71	412	50
62	181	135	3,8, & 14	245	70	322	107	413	130
63	111	136	2	247	43	323	106	415	183 & 185
64	6	137	72	248	43	324	114	420	94
65	112	138	37 & 41	249	48 & 52	325	131	423	183
66	112	139	10	250	36	326	109	424	85
67	42	140	72	252	4	328	109	425	183
68	30	142	107	253	7	329	36	429	123
69	42	144	94	254	7	330	92	432	87
70	42 & 87	148	179	255	81	333	106	433	53
71	42	149	148	256	43 & 52	334	93	434	123
72	42	150	94	257	69 & 71	335	93	435	53
74	43	152	148	258	148	336	93	440	53
75	109	153	94	259	43 & 52	337	42 & 87	441	88
76	111	155	145	260	43	338	42	444	186
82	143	157	2	261	43 & 52	339	89	445	184
86	112	158	95	265	74	340	42 & 87	447	189
91	37	159	95	266	115	341	47	448	189
92	37	162	88	268	43	342	52	449	192
93	33 to 35	163	86	269	43 & 52	343	106	450	75
95	35	164	86	271	153	344	127	451	186
98	37	165	86	272	153	347	52	452	189
99	37	166	94	273	43	348	108	454	51
105	80	170	3, 9, 12, 13, 24, 30 to 32	276	41 & 50	349	88	455	23
106	43	171	94	277	43	350	108	461	81
107	2 & 8	172	94	278	43	351	127	465	94
108	25 & 36	179	95	280	74	354	54	468	187
109	36	180	131	281	43	355	54	469	187
110	36	185	131	283	43	357	125	470	185
111	36	196	86	284	43 & 74	359	143	471	187
112	25 & 50	197	154	285	106	362	25	474	186
113	94	200	33 to 35	289	43	363	115	476	187
114	4 & 7	201	43	290	38 & 41	365	106	477	24 & 132
116	181	212	148	291	41	366	80	478	186
117	181	217	75	292	41	370	115	479	186
118	181	218	128	294	49	371	25	480	192
119	122	219	128	295	43	373	52	481	192
120	3, 9, 12, 13, 24, 30 to 32 & 154	220	128	296	43	374	52	482	192
121	86	221	128	297	43	375	42	483	192
		222	25,35 & 36	298	43	380	130	491	130
		223	75	299	114	381	80	492	132
				300	69	395	182	493	96

NUMERICAL INDEX

FIG. No.	PAGE No.	FIG. No.	PAGE No.	FIG. No.	PAGE No.	FIG. No.	PAGE No.	FIG. No.	PAGE No.
495	128	570	90	786	84	885	60 & 61	952	151
499	105	571	90	797	145	889	64 & 68	953	171
500	96	572	118	805	110	890	64 & 68	954	178
501	127	573	121	806	62,63 & 67	891	64	955	8
502	132	574	158	807	62,63 & 67	893	68	956	157
503	91	575	176	808	152	894	68	957	155
504	105	578	182	809	62,63 & 67	895	68	958	178
505	91	608	123	810	62,63 & 67	896	181	959	155 & 157
506	90	610	180	811	62 & 63	897	68	960	173
507	99	612	138	816	62 & 63	898	181	962	168, 171 to 173
508	99	613	138	817	62 & 63	899	68	963	8
509	91	614	137	820	62 & 63	901	181	964	14
510	89	620	101	825	111	902	64	965	11
513	98 to 102	621	101	826	104	903	125	967	146
514	82	626	83	828	142	904	2	968	170
515	91	627	84	829	142	905	64 & 68	969	54 & 61
517	82	629	83	830	142	907	181	972	3
518	90	634	133	831	142	908	64	975	180
520	100	647	84	832	142	910	64	976	160, 161
521	100	659	138	833	142	911	68	977	160, 161, 169 & 170
524	99	688	82	834	110	912	168 to 172	978	160
526	105	694	83	835	110	913	171 & 173	980	161
527	100	697	146	836	62 & 63	915	8	983	161
528	98	701	81	837	62,63 & 67	918	171	984	160, 161, 169 to 171
530	117	704	113	839	62,63 & 67	919	171	986	160
531	82	705	113	840	67	920	169 to 173	987	152
532	82	707	92	841	176	921	161	988	152
533	134	708	88	842	139	922	161	991	169
534	53	709	113	844	62,63 & 67	924	155	992	169
535	53	714	115	845	62,63 & 67	925	175	994	181
537	104	719	179	846	62,63 & 67	926	175	995	169 & 170
538	53	720	85	847	67	927	173	996	181
539	105	721	113	848	67	928	172	997	181
540	103	722	113	851	54 & 61	929	170	998	155
541	103	732	135	852	54 & 61	930	172	999	152
542	103	737	115	859	67	931	163	1002	149
543	103	741	124	860	62,63 & 67	932	163	1004	149
544	119	742	115	866	68	934	179	1011	166
545	119	750	124	869	181	935	179	1012	166
547	99	752	123	870	89	937	179	1015	127
548	99	753	70	872	62 & 67	938	174	1016	178
550	92	754	135	873	62 & 67	939	11	1017	131
554	159	757	124	874	62	941	150	1021	174
555	71	759	135	875	62	942	153	1024	167
558	82	762	145	876	62	944	179	1025	167
559	159	769	146	878	62	945	11	1028	172
561	90	770	146	879	62	946	11 & 73	1029	170
562	136	773	151	880	62 & 67	947	156		
565	133	775	129	881	136	948	161		
566	117	776	177	883	56 & 57	949	150		
567	168	777	167	884	58 & 59	951	151		

NUMERICAL INDEX

FIG. No.	PAGE No.	FIG. No.	PAGE No.	FIG. No.	PAGE No.	FIG. No.	PAGE No.	FIG. No.	PAGE No.
1030.....	172	1119.....	45 to 48	1196.....	16	1271.....	92	1422.....	5 & 27
1031.....	166	& 51	1197.....	16	1273.....	17 & 27	1423.....	5
1032.....	166	1123...17,27 & 40		1198.....	156	1274.....	17	1430.....	19
1040.....	74	1124...17,27 & 40		1199.....	158	1275.....	18 & 27	1431.....	20
1041.....	139	1125...18,27 & 39		1201.....	3	1279.....	171	1440.....	26
1042.....	139	1127.....	48	1205.....	189	1280.....	171	1445.....	26
1043.....	127	1128.....	48	1209...22,27 & 39		1281.....	15	1600.....	26
1044.....	73	1129.....	48 & 51	1210.....	118	1283.....	16	1601.....	10
1045.....	4,5,6,19,21 & 31	1130.....	48	1211.....	6 & 27	1284.....	15	1602.....	10
1046...19,20 & 39		1133.....	45 & 46	1212.....	6 & 27	1286.....	177	1604.....	24
1047...5,6,19 & 39		1134.....	22	1213.....	152	1287.....	158	1611.....	23
1048.....	20 & 40	1137.....	22	1214.....	152	1288.....	177	1612.....	4 & 27
1050.....	127	1143.....	45,46,50 & 51	1215.....	191	1289.....	138	1613.....	102
1051.....	175	1144.....	15 & 22	1216.....	159	1290.....	143	1621.....	20
1052...15,22 & 40		1146.....	73	1217.....	159	1291.....	143	1630.....	21
1053.....	157	1150.....	47	1218.....	2	1292.....	143	1631.....	19
1054...15,22 & 40		1151.....	47	1220.....	177	1293.....	150	1632.....	21
1056.....	174	1152.....	47	1221.....	177	1296.....	6	1634.....	22
1057.....	124	1153.....	47	1222.....	129	1297.....	130	1637.....	22
1059...21,23 & 39		1154.....	47	1223.....	122	1298.....	130	1640.....	19
1060.....	5,6,19,20 & 39	1155.....	141	1226.....	134	1299.....	137	1641.....	20
1064.....	73	1158.....	3,14 to 18	1227.....	140	1301.....	24	1660.....	19
1065.....	159	1161.....	2	1230.....	122	1302.....	128	1714.....	188
1068.....	170	1164.....	46	1231.....	129	1303.....	75	1715.....	188
1071.....	164	1165.....	46	1232.....	176	1305.....	120	1798.....	188
1072.....	164	1166.....	46	1235.....	126	1306.....	121	1901.....	65 to 67
1081.....	165	1167.....	46	1236.....	16	1309.....	137	1902.....	65 to 67
1082.....	165	1168.....	46	1238.....	92	1310.....	2	1921.....	65 & 67
1087.....	72	1169.....	45	1239.....	169	1311.....	23	1922.....	65 & 67
1089.....	167	1170.....	45	1240.....	169	1312.....	89	1930.....	67
1090.....	72	1172.....	45	1242.....	136	1313.....	102	1931.....	67
1100.....	190	1173.....	45	1243.....	135	1314.....	186	1932.....	68
1101.....	160	1174.....	45	1244.....	157	1315.....	120	1933.....	68
1102.....	160	1175.....	116	1246.....	137	1316.....	120	1936.....	68
1103.....	176	1177.....	158	1247.....	104	1319.....	102	8501.....	77
1104.....	190	1178.....	14	1248.....	104	1320.....	186	8502.....	77
1105.....	45 to 48& 51	1179.....	144	1249.....	182	1323.....	70 & 71	8503.....	77
1106.....	180	1180.....	144	1252.....	117	1324.....	102	8504.....	77
1107.....	190	1181.....	15	1253.....	69	1325.....	127	8603.....	79
1108.....	147	1183.....	16	1254.....	72	1326.....	121	9601.....	78
1109.....	41	1184.....	15	1255.....	133	1330.....	21 & 27	9602.....	78
1110.....	178	1185.....	141	1256.....	134	1331.....	14	9603.....	78
1111.....	51	1186.....	141	1258.....	69	1332.....	12	9604.....	78
1112.....	147	1187.....	141	1260.....	70	1336.....	129	9703.....	79
1113.....	147	1188.....	118	1261.....	134, 156& 158	1346.....	129		
1116.....	144	1189.....	85	1262.....	140	1399.....	102		
1117.....	144	1190.....	85	1264.....	10	1400.....	26		
1118.....	191	1191.....	85	1267.....	140	1406.....	121		
		1192.....	24	1269.....	100	1413.....	101		
		1194.....	156	1270.....	101	1416.....	120		
						1421.....	5 & 27		

ALPHABETICAL INDEX

A	PAGE
Adapter -	
Pipe to Hose	111
Adjusters -	
Hatch	145
Windshield	143 & 144
All-Round Lights	15 to 27, 34 to 36, 39, 40
.....	45 to 48, 50 & 51
Anchor Chocks	125
Anchor Lights	15 to 27, 34 to 36, 39, 40
.....	45 to 48, 50 & 51
Assemblies, Control	54, 55, 59, 61, 65 & 67
Axe Brackets	131

B	PAGE
Bass Boat Lights	4
Bells -	
Fog	94 & 95
Berth Lights	75
Bits	123
Boarding Steps	127
Bolts -	
Barrel	156 & 157
Cupboard	160
Book, Log	88
Bow -	
& Anchor Lights	15 to 18
Combination Lights	1 to 6, 30 to 35
Eyes	126
Brackets -	
Axe	179
Table	139
Breakdown Lights	45 to 50
Bulbs, Electric	42, 52, 62, 63 & 87
Butt Hinges	148 to 155
Buttons -	
Door	159
Horn Push	81

C	PAGE
Cabin -	
Door Hooks	157 & 158
Cabinet Hinges	151 to 155
Cable -	
Outlet	85
Straps	86
Caps, Gas Tank	102
Catches, Door	159, 160 & 174
Caulking Iron	116
Certification of Lights	VIII & 44
Chain -	
Deck Pipe	123
Portlight	88
Chocks	122 & 123
Chocks, Anchor	125
Clam Shell Ventilators	89

C - CONTINUED	PAGE
Clamps -	
Hatch Hold - Down	147
Spring	132
Rope	134
Cleats	117 to 121 & 123
Clips -	
Line Support	86
Trolling	187
Coat & Hat Hooks	180
Cockpit Scupper	106 & 107
Combination -	
Bow & Anchor Lights	15 to 18
Side Lights	7 to 10, 30 to 38 & 45 to 49
Connections -	
Electric	85
Thru Hull	107 to 109
Watertight, Deck	85
Connectors, Electric	85
Connectors, Garden Hose	105
Continuous Hinge	148
Control -	
Assemblies	54, 55, 59, 61, 65 & 67
Convertible Boat Top -	
Fittings	182
Courtesy Lights	72 & 73
Cowl Ventilators	89
Cupboard -	
Bolts	160
Catches	159, 160 & 174
Turns	160
Curtain Fasteners	181

D	PAGE
Deck -	
Connection, Watertight	85
Lights	13 & 74
Pipes, Rope & Chain	124
Plate Keys	104
Plates	98 to 103 & 105
Dock Line Springs	135
Dome Lights	69 to 71
Door -	
Buttons	159
Catches	159, 160 & 174
Fasteners	146 & 147
Hinges	148 to 155
Holders	158 & 159
Hooks	157 & 158
Stops	158
Drain Plugs	114 & 115
Drawer -	
Knobs	175
Pulls	176 to 178
Dredging Light	51
Dorade Ventilator	89

ALPHABETICAL INDEX

E PAGE

Elbow Catches	174
Electric -	
Bulbs	42, 52, 62, 63 & 87
Cabin Fixtures	69 to 75
Connections	85
Lamps	69 to 75
Sockets	39, 41, 52, 62, 63, 67 & 68
Switches	76 to 82
European Representative	VI
Eyes -	
Bow	126
Flange	126
Lashing	123 & 126
Lifting	123
Transom	126

F PAGE

Fasteners -	
Curtain	181
Door	146 & 147
Hatch	146 & 147
Table Leg	179
Fender-	
Hooks	137
Locks	137
Filler, Tank	98 to 103
Filters, Fuel	114
Filters, Water	96 & 97
Fishing -	
Rod Holders	189 to 192
Fittings -	
For Boat Top	181 & 182
For Rails	129 & 130
Waste	99 & 100
Fixtures, Light -	
Bulkhead, Electric	69 to 75
Electric Cabin	69 to 75
Vapor Proof	72
Flag Pole -	
Sockets	128
Flag Staffs	128
Flange Eyes	123
Flush -	
Hatch Lifting Handles	167 to 177
Hatch Lifting Rings	175 & 176
Pulls	167, 169, 171 & 176 to 178
Ring Catch	175
Fog Horn	88
Fuel -	
Filter	114
Separator	114
Strainer	114
Tank Filler	98 to 103
Fuse -	
Holder	82 to 84
Panels	82 to 84

G PAGE

Gas -	
Strainer	114
Tank Caps	98 to 103
Tank Filler	98 to 103
Tank Vents	90 & 91
Globes	43, 52 & 69 to 71
Grab Rail Posts	130
Grab Rails	130
Guides, Tiller Rope	134 & 135
Guides, Pole Line	187

H PAGE

Halyard Mount Lights	35
Handles -	
Flush Lifting	167 & 177
Sliding Window	178
Utility	129
Hasps	155 & 156
Hatch -	
Adjusters	145
Dog	167
Fasteners	146, 147 & 167
Hinges	148
Hold-Down Clamps	147
Lifting Handles	167 & 177
Lifting Rings	175 to 177
Trim	148
Support Braces	145
Hawse Hole Plate	123
Heights, Vertical Light	28 & 29
Hinges -	
Butt	149 to 151
Cabinet	151 to 155
Continuous	148
Cuddy Door	149 to 155
Hatch	149 to 155
Hatch Support	145
Non-Mortised	155
Piano	148
Pull Apart	148
Rail	131
Semi-Concealed	153
Shortside	152 to 154
Strap	154
"T"	154
Holders -	
Boat Hook	132
Door	158
Fishing Pole	189 to 192
Ring Buoy	131
Outrigger Pole	183 to 186
Hooks -	
Cabin Door	157 & 158
Coat Hook	180
Fender	137
Lashing	180

ALPHABETICAL INDEX

H - CONTINUED	PAGE
Snap	137 to 139
Utility	180
Wardrobe	180
Horn Push Button	81
Horn, Fog	88
Horns for Rowlocks	140 & 142
Hull Connections	107 to 110

I	PAGE
Information -	
Certification of Navigation Lights	VIII & 44
Electrical Standards	76
Light, Vertical Heights	28 & 29
Lock Bevels	168
Lock & Latch	162
Representatives	VI
Searchlight Bulb Data	62, 63 & 67
Sales Policy & Terms	II
Warranty	II
Inlet -	
Fittings for Fresh Water	105
Strainer	112
Iron, Caulking	116

K	PAGE
Keys, Deck Plate	104
Knobs, Drawer	175

L	PAGE
Lamps -	
Cabin	69 to 75
Wall	69 to 75
Lashing Eyes	123 & 126
Lashing Hooks	180
Latches -	
Doors	161 to 166
Flush	161 to 166
Mortise Latch Sets	169 & 173
Rim Latch Sets	169 to 172
Wood Rail	131
Leathers, Oar	141
Lenses	43, 52 & 69 to 71
Lifting Eyes	123
Light Chart, Vertical Heights	28 & 29
Lights -	
All-Round	15 to 27, 34 to 36, 39, 40
.....	45 to 48, 50 & 51
Anchor	15 to 27, 34 to 36, 39, 40
.....	45 to 48, 50 & 51
Bass Boat	4
Berth	75
Bi-Color	1 to 6 & 30 to 35
Breakdown	45 to 50
Combination	7 to 10, 30 to 38 & 45 to 49

L - CONTINUED	PAGE
Courtesy	72 & 73
Deck	13 & 74
Dredging Light	51
Dome	69 to 71
For Windshield	
Mounting	15 & 17
Mast	3, 13 to 15, 22, 30 to 32,
.....	34 to 38, & 45 to 50
Masthead	13 to 15, 22, 30 to 32,
.....	34 to 38, & 45 to 50
Meal & Absent	36
Not Under-Command	45 to 50
Pole	4 to 6, 15 to 24, 26 & 27
Range	45 to 50
Searchlights	53 to 68
Side	7 to 10, 30 to 38 & 45 to 49
Signal	30 to 38 & 45 to 49
Spreader	74
Stern	11, 12, 30 to 34, 36 to 38 & 45 to 49
Towing	33, 34, 36 to 38 & 45 to 49
Utility	72 & 73
Vapor-Proof	72
Line Support Clips	86
Locks -	
Doors	162 to 173
Fender	137
Flush	161 to 167
Mortise	169 & 173
Rim	169 to 172
Window	179
Log Book	88
Lock Ventilators	92
Louver Ventilators	93

M	PAGE
Mast Lights	3, 13 to 15, 22, 30 to 32,
.....	34 to 38, & 45 to 50
Masthead	13 to 15, 22, 30 to 32,
.....	34 to 38, & 45 to 50
Meal & Absent Light	36
Mooring Bitts	123
Navigation Lights -	
For Vessels:	
Under 20 Meters (65.6 Ft.) in Length	1 to 43
Over 20 Meters (65.6 Ft.) in Length	44 to 52

O	PAGE
Oar -	
Leather & Buttons	141
Locks	140 to 142
Outlets -	
Cable	85
Water	105
Outrigger -	
Holders	183 to 186

ALPHABETICAL INDEX

O - CONTINUED PAGE

Kit	187
Pole Line Guides	187
Poles	188
Spreaders	188
Trolling Pins	187

P PAGE

Paint Scraper	116
Palm, Sewing	116
Panels -	
Fuse	82 to 84
Switch	82
Piano Hinge	148
Pin, Trolling	187
Pipes, Rope Deck	124
Plates -	
Deck	98 to 103 & 105
Hawse Hole	123
Step	127
Plugs, Drain	115 & 116
Pole Holders -	
Replacement Bases	189 to 200
Replacement Poles	26 & 27
Vertical Height Chart	28 & 29
Pole Lights	4 to 6, 15 to 24, 26 & 27
Pole Sockets, Flag	128
Poles -	
Flag	128
Outrigger	188
Posts -	
Grab Rail	130
Stanchion	130
Pulleys	133
Pulls -	
Drawer	176 to 178
Flush	167, 169, 171 & 175 to 178
Pump Strainers	114

R PAGE

Rail -	
Fittings	130 & 131
Hinges & Latches	131 & 148
Rails, Grab	130
Range Lights	45 to 50
Representatives	VI
Rigging Tube	125
Rim Locks	162 to 166 & 168 to 173
Rim Latches	162 to 166 & 168 to 173
Ring -	
Buoy Holders	131
Catches, Flush	175
Pulls	167 & 175 to 177
Rings, Hatch Lifting	175 to 177
Roller Tip Line Guide	187

R - CONTINUED PAGE

Rope -	
Clamps	134
Guides	134 & 135
Pulleys	133
Rope Tighteners	135
Rowlocks	140 to 142

S PAGE

Safety Cable	104
Scraper	116
Scuppers -	
Cockpit	106 & 107
Thru-Hull	107 to 109
Valve Assembly	106
Seacocks	110
Searchlights -	
Bulbs	62, 64 & 87
Control Assemblies	54, 55, 59, 61, 65 & 67
Spare Parts	53, 62, 64, 67 & 68
Searchlights	53 to 68
Separator, Fuel	114
Shield, for Pole or Mast Lights	24
Side Lights	7 to 10, 30 to 38 & 45 to 49
Signal Lights, Portable	
or Fixed	30 to 38 & 45 to 49
Snap Hooks	137 to 139
Sockets -	
Boat Cover	182
Electric	39, 41, 52, 62, 63, 67 & 68
Fishing Rod	189 to 200
Flag Pole	128
Rowlock	140 & 141
Searchlight	62, 63, 67 & 68
Spreaders for Outrigger Poles	188
Spreader Lights	74
Spring Clamps	24 & 132
Springs for Dock Line	135
Spring, Tiller Rope	135
Staffs, Flag	128
Steps -	
Boarding	127
Folding	127
Step Plates	127
Stern -	
Lights	11, 12, 30 to 34, 36 to 38 & 45 to 49
Pole Lights	4 to 6, 15 to 24, 26 & 27
Stops -	
Door	158
Window	179
Strainers -	
Fuel	114
Gasoline	114
Thru-Hull	107
Inlet	96, 97 & 112
Pump	113
Water	96 & 97

ALPHABETICAL INDEX

S - CONTINUED PAGE

Strap Hinges	154
Strap Cable	86
Switch Panels	82
Switches -	
Battery	76 to 79
Electric	76 to 79
Master	77
Panel	82
Swivel -	
Eye Pulleys	133
Eye Snaps	138 & 139

T PAGE

"T" Hinges	154
Table Brackets	179
Table Leg Fasteners	179
Terminal Blocks	84
Thru-Hull Connections	107 to 109
Towing Lights	33, 34, 36 to 38 & 45 to 49
Transom -	
Eyes	126
Stern Lights	11, 12, 30 to 34, 36 to 38
Ventilators	92 & 93
Trim Hatch	148
Trolling Pin	187
Tube, Rigging	125
Tri-Color Lights	3
Turns Cupboard	160

U PAGE

Universal Replacement Pole Light	26 & 27
Utility Hooks	180
Utility Lights	72 & 73

V PAGE

Vapor Proof Fixtures	72
Ventilator -	
Cowl	89
Dorade	89
Gas Tank	90 & 91
Locker	92
Louver	93
Clam Shell Type	89
Transom	92

W PAGE

Wardrobe Hooks	180
Warranty Information	II
Waste Fitting	99 & 100
Water Strainers	96

W - CONTINUED PAGE

Water Strainer Graphs	97
Whistle	88
Window -	
Anti-Rattler	179
Handle, Sliding	178
Lock	179
Stop	179
Windshield -	
Adjusters	143 & 144
Keeper Plate	145 & 146
Pole Lights for	4 to 6, 15 to 24, 26 & 27
Wiper	134

PERKO®

The Difference is Distinctive®

**WE ARE MEMBERS OF THE
FOLLOWING MARINE ASSOCIATIONS**



**NATIONAL MARINE
MANUFACTURERS ASSOCIATION**



**AMERICAN BOAT AND YACHT COUNCIL, INC.
CHARTER MEMBER**



**MARINE RETAILERS ASSOCIATION
OF AMERICA**



**NATIONAL MARINE REPRESENTATIVES
ASSOCIATION**



**NATIONAL MARINE DISTRIBUTORS
ASSOCIATION**



**MARINE INDUSTRIES ASSOCIATION
OF SOUTH FLORIDA**



**IGFA
Corporate
Member**

INTERNATIONAL GAME FISH ASSOCIATION

Street Address:

**16490 N.W. 13th Avenue
Miami, Florida 33169-5707**

Telephone Number:

305-621-7525

Mailing Address:

**P.O. Box 64000D
Miami, Florida 33164-0510**

Fax Number:

305-620-9978

MANUFACTURER OF MARINE LIGHTS, HARDWARE AND ACCESSORIES

WE MAKE IT RIGHT. RIGHT HERE!

PERKO®

The Difference is Distinctive®

Manufacturer of Marine Lights, Hardware and Accessories
We Make It Right. Right Here!!