

# PERKO®

*Shaping the Wave of Excellence™*

## CATALOG NO. 290 2001 - 2002

### STREET ADDRESS

16490 NORTHWEST 13TH AVENUE  
MIAMI, FLORIDA 33169-5707

### MAILING ADDRESS

P.O. BOX 64000D  
MIAMI, FLORIDA 33164-0510

### TELEPHONE NUMBER

(305) 621-7525

### FAX NUMBER

(305) 620-9978

### INTERNET WEB SITE

WWW.PERKO.COM

© Perko, Inc. 2000  
All Rights Reserved

Portions of this Catalog  
Previously Copyrighted in  
1936 - 1999 Inclusive



MADE IN USA



MANUFACTURER OF  
SHIP AND BOAT EQUIPMENT

NAVIGATION LIGHTS FOR  
VESSELS UNDER 20 METERS  
1 - 40

NAVIGATION LIGHTS FOR VESSELS OVER  
20 METERS  
41 - 53

SEARCHLIGHTS  
54 - 76

LIGHTING FIXTURES,  
BULBS AND  
BATTERY SWITCHES  
77 - 91

COMPARTMENT VENTILATORS,  
AND BELLS  
92 - 97

STRAINERS, UNDERWATER HARDWARE  
DECK PLATES, FILLS & VENTS  
98 - 124

DECK HARDWARE, GLEATS,  
CHOCKS, BITTS, BOW EYES,  
ROWLOCKS, WINDSHIELD &  
HATCH ADJUSTERS  
125 - 153

CABINET HARDWARE,  
DOOR LOCKS & LATCHES,  
HINGES, HOOKS ETC.  
154 - 188

FISHING EQUIPMENT  
189 - 198

# GENERAL INFORMATION

## **SALES POLICY**

PERKO Products are sold through our established Distributors. We do not sell direct to the public or organizations. Therefore, possession of this catalog does not infer an offer to sell. Please contact your local marine supplier.

## **PRICES AND TERMS**

Our costs are subject to change due to causes beyond our control. Therefore, our price list is only intended for the guidance of our customers and does not necessarily establish current prices. A *Repackaging Service Charge of \$5.00 net will apply to all broken packages.* All prices are subject to change without notice. Terms are 1% 10 days, net 30 days.

Orders from firms having no satisfactory history or credit rating with us must be prepaid. C.O.D. shipments will be made if a 25% deposit is sent with order. Cash discounts do not apply to C.O.D. shipments.

## **FIVE YEAR LIMITED WARRANTY**

PERKO, INC. (PERKO) warrants to the original consumer-purchaser that PERKO'S consumer products will be free from defective materials or workmanship, and that the PERKOPLATE/PERKO•KOTE Finish will remain corrosion-free under normal use and service, for a period of five (5) years from the original purchase date.

**ALL IMPLIED WARRANTIES, INCLUDING MERCHANTABILITY, ARE ALSO LIMITED IN DURATION TO THE FIVE YEAR PERIOD FROM THE ORIGINAL PURCHASE DATE.**

**PERKO SHALL NOT BE LIABLE FOR LOSS OF USE OF ANY OF ITS CONSUMER PRODUCTS, NOR FOR OTHER INCIDENTAL OR CONSEQUENTIAL COSTS, EXPENSES, OR DAMAGES INCURRED BY THE ORIGINAL CONSUMER-PURCHASER**

**OR BY ANY OTHER PERSON.**

**SOME STATES DO NOT ALLOW LIMITATIONS ON HOW LONG AN IMPLIED WARRANTY LASTS, SO THE ABOVE LIMITATION MAY OR MAY NOT APPLY TO YOU. SOME STATES DO NOT ALLOW THE EXCLUSION OR LIMITATION OF INCIDENTAL OR CONSEQUENTIAL DAMAGES, SO THE ABOVE LIMITATION OR EXCLUSION MAY OR MAY NOT APPLY TO YOU.**

This warranty is void if the consumer product warranted has been damaged by accident or unreasonable use, neglect, improper service or other cause not arising out of defects in material or workmanship. Excluded from this warranty are Electric Light Bulbs (lamps), Sealed Beam Units and Fuses.

During the warranty period, your PERKO product will either be repaired or it will be replaced with a like product (at PERKO's option) without charge to the original consumer-purchaser, when returned prepaid and insured, with proof-of-purchase date to PERKO at our Factory in Miami, FL. In the event of replacement, the replacement product will continue the warranty of the original product, or ninety (90) days, whichever is longer. **Important: For this Warranty to be effective PERKO must be supplied with Proof-Of-Purchase date of the product.**

PERKO does not authorize any person or company to create for it any other obligation or liability in connection with any of its products.

## **DESIGNS**

For the purpose of constant improvement in our products, the designs and specifications are subject to change without notice.

## **RETURN GOODS**

Products made to order are not returnable. Stock products in new, saleable condition are only returnable when permission has been granted by us, and are subject to handling and repackaging charges. Return shipping charges must be prepaid. Purchase date and invoice number are required when requesting an R.G.A. (Return Goods Authorization) number. Permission must be requested within 30 days after receipt of goods.

## **WEIGHTS**

The weights given in this catalog are approximate, but should be sufficient for general purposes.

## **SHIPPING INSTRUCTIONS**

Customers should send specific shipping instructions; otherwise, we will use our own judgement in selecting route.

## **SHIPMENTS**

**F.O.B. our plant, Miami, Florida,** unless quoted otherwise. We are not responsible for damage, loss or delay after goods are delivered to carrier. When loss or delay occurs, we will gladly assist in tracing or expediting, but such assistance is no criterion of responsibility.

When there is **loss or apparent visible damage** to a shipment, when tendered for delivery, **do not** give the carrier a clear receipt. Note such damage on the carrier's delivery receipt and **have the driver sign the receipt.**

## **CONCEALED DAMAGE OR LOSS**

1. Advise the delivering carrier in writing as soon as discovered or at least no more than 15 days after delivery, and request carrier to make an inspection.
2. **Retain** for the carrier's inspection, the **container and all packaging** that the damaged or lost material was packaged in.
3. **Shortages** - Must be reported to us within 15 days after receipt of goods.

# ***Our Modern Self-Contained Facility***

***425,000 Sq. Ft. Home of PERKO, Inc.  
Located on 16 Acres in Miami, Florida***



***Computerized  
Tool & Die Dept.***

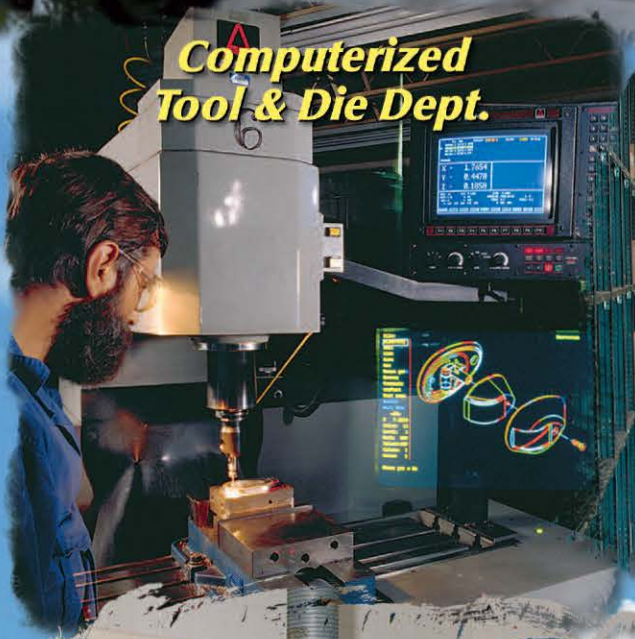

***Finished Goods  
Inventory***



***Quality Control Lab  
Atomic Absorption Spectrophotometry***



# ***Our Modern, Self-Contained, Vertically***

***Die Cast Department***

***State-of-the-Art  
Sand Cast Foundry***

***CNC Drilling And  
Tapping Centers***

***Searchlight  
Department***

***Mechanical Power Press  
Department***

# ***Integrated Manufacturing Facility***

***Plastic Injection Molding Department***

***Battery Switch Assembly Department***

***PERKOPLATE Plating Department***

***Ultrasonic Bonding of Navigation Light Lenses***

***CNC Machining Center***



# REGIONAL SALES REPRESENTATIVES

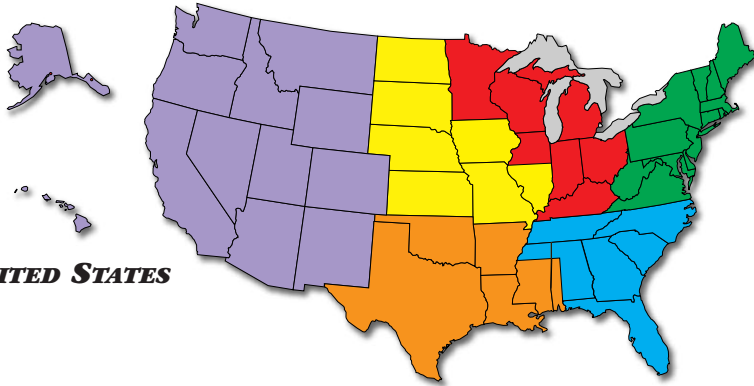

UNITED STATES

## NORTHEAST

**NEW HAMPSHIRE, VERMONT, NEW YORK, CONNECTICUT, COASTAL MAINE & CENTRAL CANADA**

CGW Associates  
P.O. Box 414  
Scituate, MA 02066  
Phone: 781-545-3790/Fax: 781-545-0359  
E-Mail: CGWCO@aol.com  
**CHARLES W. O'CONNOR**

**NEW JERSEY, LONG ISLAND, NEW YORK, SO. MASS., RHODE ISLAND**

CGW Associates  
137 Brandt Island Road  
Mattapoisett, MA 02739  
Phone: 508-758-2980/Fax: 508-758-9705  
E-Mail: CGWWO@aol.com  
**WAYNE OLIVIERA**

**DELAWARE, PENNSYLVANIA, MARYLAND, VIRGINIA**

CGW Associates  
1070 Ulmstead Circle, Arnold, MD 21012  
Phone: 410-757-9630/Fax: 410-757-4365  
E-Mail: KWCGW@aol.com  
**KEVIN WILLIAMS**

**CENT. MAINE, E. CANADA, NO. MASS.**

CGW Associates  
4 King Street Ct., Rockport, MA. 01966  
Phone: 978-546-2085 Fax: 978-546-5820  
E-Mail: CGWJH@gis.net  
**JACK HOGAN**

## SOUTHEAST

**NORTH CAROLINA**

The Gartner Group  
3313 Highway 70 East, New Bern, NC 28560  
Phone: 252-633-1210/Fax: 252-633-1692  
E-Mail: ken@thegartnergroup.com  
E-Mail: leifr@thegartnergroup.com  
**KEN WILLIAMS & LEIF ERIKSSON**

**SOUTH CAROLINA & GEORGIA**

The Gartner Group  
1313 Woodpecker Lane  
Hanahan, SC 29406  
Phone: 843-797-3073/Fax: 843-764-3511  
E-Mail: johnny@thegartnergroup.com  
**JOHNNY THOMERSON**

**TENNESSEE, MOST OF ALABAMA & NO. MISSISSIPPI**

The Gartner Group  
Mac-Hugh & Associates  
9411 Raven Hollow Rd, Brentwood, TN 37027  
Phone: 615-370-4132/Fax: 615-373-3867  
E-Mail: bob@thegartnergroup.com  
**ROBERT TAYLOR**

**WESTERN & CENTRAL FLORIDA**

The Gartner Group  
3345 Park Grove Ct., Longwood, FL 32779  
Phone: 407-333-1407/Fax: 407-805-9305  
E-Mail: tripp@thegartnergroup.com  
**TRIPP HAMMACK**

**EASTERN & SOUTHERN FLORIDA**

The Gartner Group  
2470 N.E. 22 Street/ P.O. Box 50227  
Pompano Beach, FL 33062  
Phone: 954-781-4303/Fax: 954-781-4412  
E-Mail: jack@thegartnergroup.com  
E-Mail: jay@thegartnergroup.com  
**JACK BARNES & JAY BARNES**

## MIDWEST 1

**MISSOURI, IOWA, NO. & SO. DAKOTA & NEBRASKA**

Midwestern Sales Co., Inc.  
9849 Briar Drive, Overland Park, KS 66207  
Phone: 913-649-1270/Fax: 913-648-2885  
E-Mail: MWS2000@swbell.net  
**DENNIS WILLS & TIM ALLEN**

**KANSAS, SO. ILLINOIS & SO. MISSOURI**

Midwestern Sales Co., Inc.  
4925 W. Spinnaker Lane, Willard, MO 65781  
Phone: 913-649-1270, 417-742-4653  
Cell: 417-860-7486 Fax: 417-742-4420  
E-Mail: Offshoreguy@aol.com  
**SCOTT MORRISON**

## MIDWEST 2

**NO. ILLINOIS, MINNESOTA, WISCONSIN**

Inland Marketing Associates, Inc.  
3939 East Hwy 12/P.O. Box 680  
Michigan City, IN 46360  
Phone: 219-879-2707/Fax: 219-879-5224  
E-Mail: ehender@niaa.net  
**EARL HENDERSON**

**ILLINOIS, INDIANA & KENTUCKY**

Inland Marketing Associates, Inc.  
1071 Highland Ct./P.O. Box 414  
Plymouth, IN 46563  
Phone: 219-936-6972/Fax: 219-936-8248  
E-Mail: eddiek@dnsonline.net  
**ED KUYKENDALL**

**MICHIGAN, OHIO**

Inland Marketing Associates, Inc.  
500 S. Washington/Suite 1  
Royal Oak, MI 48067  
Phone: 248-541-4404/Fax: 248-541-4405  
E-Mail: burt2310@email.msn.com  
**R. WILLIAM BURT**

## SOUTH CENTRAL

**TEXAS, OKLAHOMA, ARKANSAS**

MAC-HUGH & Associates, Inc.  
11018 FM 2354, Baytown, TX 77520  
Phone: 281-383-2235/Fax: 281-383-2235  
**HUGH W. MULHOLLAND**

**LOUISIANA, WESTERN ALABAMA, SO. MISSISSIPPI, SO. EAST ARKANSAS,**  
MAC-HUGH & Associates, Inc.  
5540A Pepsi Street, Harahan, LA 70123  
Phone: 504-734-9411/Fax: 504-734-5144  
**KYLE McHUGH, BUZZ HUMPHREY,**  
**DAVID HILDRETH, GARRETT MCHUGH &**  
**KYLE MICHAEL MCHUGH, JR.**

## WEST

**CALIFORNIA, NEVADA, UTAH, COLORADO, ARIZONA, NEW MEXICO HAWAII, WASHINGTON, ALBERTA, BRITISH COLUMBIA, ALASKA, OREGON, IDAHO,**

**MONTANA, WYOMING**  
Pacific Marine Marketing, Inc.  
3368 McGraw Lane, Lafayette, CA 94549  
Phone: 925-284-4855/Fax: 925-284-4856  
E-Mail: w.moovers@att.net  
**WAYNE R. MOOERS**

Pacific Marine Marketing, Inc.  
Mail: P.O. Box 366,  
Shipping: 20575 Wildwood St., Indianola, WA 98342  
Phone: 360-297-1632/Fax: 360-297-5002  
E-Mail: rickcpmm@aol.com  
**RICK COLLIER**

**COMMERCIAL PRODUCTS**

B.A. Griffin Associates, Inc.  
355 Grow Ave. N.W.  
Bainbridge Island, WA 98110  
Phone: 206-780-0509/Fax: 206-855-9080  
E-Mail: bagriffin@earthlink.net  
**BARRY GRIFFIN**

## INTERNATIONAL

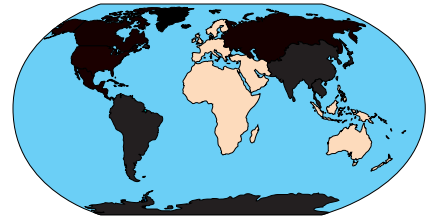

**EUROPE, SO. EAST ASIA, AFRICA, MIDDLE EAST & AUSTRALIA**

Greenwich Trading Co.  
**Head Office**  
256 Post Rd. East, Suite 205  
Westport, CT 06880  
Phone: 203-266-9697/Fax: 203-266-9935  
E-Mail: grntrade@aol.com  
**DANIEL J. LYONS & DAVID ANAI**

Greenwich Trading Co.  
**European Office**  
Linnicher Strasse 33, D-52428  
Jülich, Germany, Phone: 49.2461.346915  
Fax: 49.2461.346924  
E-Mail: GTCEurope@aol.com  
**ULRICH WITTFELD, DIPL-LNG**

Greenwich Trading Co.  
**Middle East Office**  
P.O. Box 61286 Jebel Trade Zone  
Dubai, U.A.E.  
Phone: 971.4.8813.167/Fax: 971.4.8813.168  
E-Mail: Greenwichmideast@hotmail.com  
**HAKIM M. YUSUF**

**For Information on all Export & Foreign Regions Contact:**  
**Jose Martinez at Perko, Inc.**

# DEALER PACKAGE PROGRAM

*SINCE THE PUBLICATION OF OUR LAST CATALOG, WE HAVE RE-DESIGNED THE LOOK OF OUR DEALER PACKAGING PROGRAM. IN ADDITION WE ARE CONTINUING TO INCREASE THE NUMBER OF PRODUCTS AVAILABLE IN "DEALER PACK" FORM. THESE ATTRACTIVE NEW PACKAGES WILL CONTINUE TO MAKE PERKO PRODUCTS EASIER TO SELL . . . AND EASIER FOR THE CUSTOMER TO BUY.*

*OUR COMMITMENT TO BETTER DEALER/DISTRIBUTOR SALES AND PROFITS IS BACKED BY OUR CONTINUING PROGRAM OF SERVICE AND SUPPORT. IT'S A PERKO PLUS!*

*AS YOU LOOK THROUGH THIS CATALOG YOU WILL FIND SYMBOLS, SIMILAR TO THE ONE BELOW, THAT REPRESENT THE "DEALER PACKED" ITEMS. SEVERAL OF OUR "DEALER PACK" STYLES ARE ILLUSTRATED BELOW.*

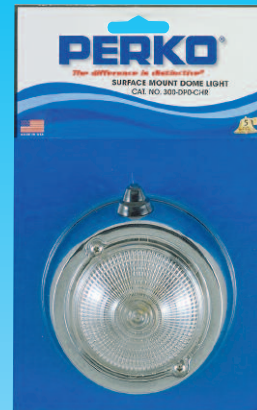

**BLISTER PACK**

**SKIN PACK**



Sample of Package on a Display Wall



**GLAM SHELL**

**GLAM SHELL**

## NAVIGATION LIGHT APPROVALS

### U.S.A. AND INTERNATIONAL APPROVALS OF NAVIGATION LIGHTS FOR VESSELS UNDER 20 METERS (65.6 FT.) IN LENGTH.

The U.S.C.G. regulates and enforces the configuration and carriage of lights on recreational boats, but industry standards regulate the design, manufacture, and certification of the lights. The only means of certification recognized in the United States is through the NMMA certification procedure. Our Navigation lights are certified under the NMMA Certification Procedure. The marking "A-16" on the light fixture indicates this certification. Therefore, the proper installation of a current model of PERKO navigation lights will assure the meeting of the U.S. regulation in effect at the time.

Certain models and configurations of PERKO navigation lights have been approved for use in over 50 countries by their respective governing authorities. Where required, appropriate approval markings are on these navigation lights. However, due to frequent changes and additions to the approval list, contact PERKO for the latest information concerning model selection for a particular purpose and/or use in a particular country.

**All PERKO navigation lights are approved under the regulations developed by the International Maritime Organization ('72 COLREGS) and are approved for use in international waters.** The countries accepting the '72 COLREG regulations for navigation lights used in their territorial waters include the countries of South America, Africa, the Middle East and Far East (except Japan where only lights made in Japan are accepted), Australia, New Zealand, Canada, Spain and Greece (pending government stability). Several European countries have additional regulations and require separate approvals for navigation lights used in their territorial waters in accordance with those regulations. The European countries where specific PERKO navigation lights are approved or have approval pending for use in their territorial waters and those specific lights are shown below.

The following chart summarizes European approvals at time of publication.

Note: New "Reduced Glare" Design series lights are pending approvals. Contact PERKO for the latest information.

P = Approved for Power Driven Vessels and Sailing Vessels Operating Under Auxiliary Power.

S = Approved for Sailing Vessels Operating Under Sail Alone.

AP = Approval Pending.

#### Bi-Color Lights

#### Side Lights

#### Tri-Color

Country	Vessel Size In Meters	120	170	200B	200T	252	972	1310	1161	1612	120	170	200B	253	955	963	1601	200TB
Denmark	Under 7 (23.0 ft.)	P&S		P&S	P&S						P&S		P&S					S
	Under 12 (39.4 ft.)	P&S		P&S	P&S						P&S		P&S					S
Finland	Under 7 (23.0 ft.)	P&S		P&S	P&S			P&S	P&S	P&S	P&S		P&S			P&S	P&S	
	Under 12 (39.4 ft.)	P&S		P&S	P&S						P&S		P&S♦					
France	Under 12 (39.4 ft.)†	P&S		P&S				P&S	P&S	P&S	P&S		P&S	AP				P&S
	Under 20 (65.3 ft.)			P&S		AP							P&S	AP				P&S
Italy♥	Under 12 (39.4 ft.)	P&S	P&S	P&S	P&S	AP	P	P	P		P&S	P&S	P&S	AP	P&S	P		S
	Under 20 (65.3 ft.)		P&S	P&S	P&S	AP						P&S	P&S	AP				S
Norway	Under 7 (23.0 ft.)	P&S		P&S	P&S	AP					P&S		P&S					
	Under 12 (39.4 ft.)			P&S	P&S								P&S					
Sweden	Under 7 (23.0 ft.)	AP		AP	AP						AP		AP					
	Under 12 (39.4 ft.)			AP	AP								AP					
United Kingdom	Under 12 (39.4 ft.)	P&S		P&S	P&S	AP		P	P	P	P&S		P&S	AP			P	S
	Under 20 (65.3 ft.)			P&S	P&S	AP							P&S♦	AP				S

#### Masthead Lights

#### Combination Masthead & White All Round Lights

Country	Vessel Size In Meters	120	120 BMD	170	200B	964	1178	1331	200	1123	1123	1125	1181	1183	1184	1196	1197
					200T				MAB								
Denmark	Under 7 (23.0 ft.)	P															
	Under 12 (39.4 ft.)	P															
Finland	Under 7 (23.0 ft.)	P	P		P				P								
	Under 12 (39.4 ft.)	P	P		P				P								
France	Under 12 (39.4 ft.)†	P			P												
	Under 20 (65.3 ft.)				P												
Italy♥	Under 12 (39.4 ft.)	P	P	P	P	P	P	P	P	P&S♣	P&S♣	P&S♣	P&S♣	P&S♣	P&S♣	P&S♣	P&S♣
	Under 20 (65.3 ft.)			P	P		P	P	P	P&S♣	P&S♣	P&S♣	P&S♣	P&S♣	P&S♣	P&S♣	P&S♣
Norway	Under 7 (23.0 ft.)	P			P												
	Under 12 (39.4 ft.)				P												
Sweden	Under 7 (23.0 ft.)	AP			AP												
	Under 12 (39.4 ft.)	AP			AP												
United Kingdom	Under 12 (39.4 ft.)	P	P		P				P								
	Under 20 (65.3 ft.)				P				P								

#### Stern Lights

#### White All Round Lights

Country	Vessel Size In Meters	120	170	200B	939	945	946	965	120	200B	200H	1301	1611	1134	1430	1630	1631
				200T					SWB					1137	1660	1640	1631
Denmark	Under 7 (23.0 ft.)	P&S		P&S						P&S☆	P&S☆						
	Under 12 (39.4 ft.)	P&S		P&S						P&S☆	P&S☆						
Finland	Under 7 (23.0 ft.)	P&S		P&S						P&S	P&S						
	Under 12 (39.4 ft.)	P&S		P&S						P&S	P&S						
France	Under 12 (39.4 ft.)†	P&S		P&S					P&S	P&S☆	P&S☆	P&S	P&S	P&S	P&S	P&S	P&S
	Under 20 (65.3 ft.)			P&S♦						P&S♦☆	P&S♦☆						
Italy♥	Under 12 (39.4 ft.)	P&S	P&S	P&S	P&S	P&S	P&S	P	P&S	P&S☆	P&S☆	P&S	P&S	P&S	P&S	P&S	P&S
	Under 20 (65.3 ft.)		P&S	P&S♦	P&S	P&S	P&S		P&S	P&S♦☆	P&S♦☆	P&S	P&S	P&S	P&S	P&S	P&S
Norway	Under 7 (23.0 ft.)	P&S		P&S						P&S☆	P&S☆						
	Under 12 (39.4 ft.)			P&S						P&S☆	P&S☆						
Sweden	Under 7 (23.0 ft.)	AP		AP													
	Under 12 (39.4 ft.)			AP													
United Kingdom	Under 12 (39.4 ft.)	P&S		P&S					P&S	P&S☆	P&S☆	P&S	P&S	P&S	P&S	P&S	P&S
	Under 20 (65.3 ft.)			P&S♦					P&S	P&S♦☆	P&S♦☆	P&S	P&S	P&S	P&S	P&S	P&S

♣ Approved for use on Pleasure and Commercial Craft.

♥ Approved for Use on Pleasure Craft Only.

♦ Approved for Use on All Vessels Under 50 Meters (164.0 ft.) in Length.

♣ Approved as White All-Round Light Only for Vessels Operating Under Sail Alone.

☆ Approval Includes Red & Green All-Round Lights.

† France Allows the Use of All Lights on Vessels under 7 Meters (23.0 ft.) Regardless of Approval Status.



# State of the Art Technology

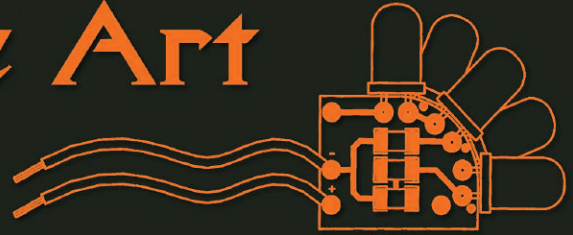

*with a Touch  
of ...  
Class*



- Water Resistant
- Long Life
- Conserves Energy
- Low Heat

# L.E.D.

## Navigation Lights



## SETS OF NAVIGATION LIGHTS

The lights that appear on this page are sets of navigation lights that complement each other in styling and design. They appear on the following pages grouped by function, rather than by style; therefore, use this page as a guide for selection of individual lights to form a series. A representative variety of available finishes (e.g. white, chrome or black) are shown below -- refer to the lights as listed on the following pages for specific availability in the desired style.

*CERTIFIED FOR USE ON POWER DRIVEN VESSELS UNDER 12 METERS (39.4 FT.) AND UNDER 20 METERS (65.6 FT.) IN LENGTH.*



**Fig. 601 & 602 Side Lights**  
See Page 7

*CERTIFIED FOR USE ON POWER DRIVEN VESSELS UNDER 20 METERS (65.6 FT.) IN LENGTH.*



**Fig. 228 Side Lights**  
See Page 10

**Fig. 227 Bi-Color**  
See Page 3

*CERTIFIED FOR USE ON POWER DRIVEN VESSELS UNDER 20 METERS (65.6 FT.) IN LENGTH.*



**Fig. 253 Side Lights**  
See Page 10

**Fig. 252 Bi-Color**  
See Page 3

**Fig. 254 Side Lights**  
See Page 8

*CERTIFIED FOR USE ON SAIL OR POWER DRIVEN VESSELS UNDER 12 METERS (39.4 FT.) IN LENGTH.*



**Fig. 915 Side Lights**  
See Page 11

**Fig. 904 Bi-Color**  
See Page 4

**Fig. 955 Side Lights**  
See Page 8

*CERTIFIED FOR USE ON SAIL OR POWER DRIVEN VESSELS UNDER 12 METERS (39.4 FT.) IN LENGTH.*



**Fig. 963 Side Lights**  
See Page 11

**Fig. 972 Bi-Color**  
See Page 4

**Fig. 965 Stern**  
See Page 12

**Fig. 945 Stern**  
See Page 12

**Fig. 964 Masthead**  
See Page 15

*FIG. 120 SERIES: CERTIFIED FOR USE ON SAIL OR POWER DRIVEN VESSELS UNDER 12 METERS (39.4 FT.) IN LENGTH.*

*FIG. 170 SERIES: FOR USE ON SAIL OR POWER DRIVEN VESSELS UNDER 20 METERS (65.6 FT.) IN LENGTH.*



**Fig. 120/170 Side Lights**  
See Page 9

**Fig. 120/170 Bi-Color**  
See Page 28

**Fig. 120/170 Stern**  
See Page 13

**Fig. 120/170 Masthead**  
See Page 14

Note: This Series of Lights Also Appears on Pages 28 & 29 as a Complete Series.

## BI-COLOR LIGHTS

PATENT No. 4,500,947

**RED AND GREEN LENSES (12 VOLT BULB INCLUDED).**

**FIG. 227 - CERTIFIED FOR USE ON POWER DRIVEN VESSELS  
UNDER 20 METERS (65.6 FT.) IN LENGTH.**

**CONSTRUCTION:**

- \* **CHROME PLATED ZINC ALLOY TOP**  
**WITH BLACK PLASTIC BASE**



**ORDERING INFORMATION**

Finish	Length Inches	Width Inches	Vertical Height Inches	Dealer Pkg. 5 Cards 1 Pc. per Card	OEM Bulk Pkg. 50 Pcs.	Screw Size	Weight Ounces
Chrome-12V	3-1/4	2-5/16	5/8	227 DP CHR	227 000 CHR	8	3

Spare Bulbs (2 per card), Cat. No. 71 DP CLR.

Spare Lens (1-Red/Green), Cat. No. 227 DP LNS.

Spare Black Base with Socket Assembly, Cat. No. 227 000 99A.



**FIG. 227  
CHROME TOP**



**FIG. 252 - CERTIFIED FOR USE ON POWER DRIVEN VESSELS  
UNDER 20 METERS (65.6 FT.) IN LENGTH.**

**CONSTRUCTION OPTIONS:**

- \* **CHROME PLATED BRONZE TOP**  
**WITH BLACK PLASTIC BASE**
- \* **ALL BLACK PLASTIC**
- \* **ALL WHITE PLASTIC**



**ORDERING INFORMATION**

Finish	Length Inches	Width Inches	Vertical Height Inches	Dealer Pkg. 5 Cards 1 Pc. per Card	OEM Bulk Pkg. 25 Pcs.	Screw Size	Weight Ounces
Chrome-12V	3-1/2	2-1/4	13/16	252 MB DP1	252 MB 12V	8	3
Black-12V	3-1/2	2-1/4	13/16	252 BB DP1	252 BB 12V	8	3
White-12V	3-1/2	2-1/4	13/16	252 WB DP1	252 WB 12V	8	3

Spare Bulbs (2 per card), Cat. No. 71 DP CLR.

Spare Black Base with Socket Assembly, Cat. No. 114 000 BLK.

Spare Lens (1-Red/Green), Cat. No. 247 DP LNS.

Spare White Base with Socket Assembly, Cat. No. 114 000 WHT.



**FIG. 252  
CHROME TOP**



**FIG. 252  
BLACK**



**FIG. 252  
WHITE**



**FIGS. 1310/1161 - CERTIFIED FOR USE ON POWER DRIVEN  
VESSELS UNDER 12 METERS (39.4 FT.) IN LENGTH.**

**CONSTRUCTION:**

- \* **BLACK PLASTIC BASE**

**FIG. 1310 - CHROME PLATED ZINC ALLOY TOP**

**FIG. 1161 - CHROME PLATED BRONZE TOP**



**ORDERING INFORMATION**

Dimensions Base Inches	Vertical Height Inches	Dealer Pkg. 5 Cards 1 Pc. per Card	OEM Bulk Pkg. 50 Pcs.	Screw Size	Weight Ounces
4 x 3-1/8	1	1310 DP CHR	1310 000 CHR	8	5-1/2
4 x 3-1/8	1	1161 DP CHR	1161 000 CHR	8	5-1/2

Spare Bulbs (2 per card), Cat. No. 71 DP CLR.

Spare Lens Set (1-Red & 1-Green), Cat. No. 283 DPA LNS.

Spare Base with Socket Assembly, Cat. No. 136.



**FIG. 1310 & 1161**



**NOTE: To Use THE LIGHTS ON THIS PAGE IN A 24 VOLT SYSTEM, ORDER REPLACEMENT BULBS (2 PER CARD) CAT. No. 72 DP1 CLR.**

NAVIGATION LIGHTS FOR VESSELS UNDER 20 METERS

## BI-COLOR LIGHTS

PATENT No. 4,500,947

**RED AND GREEN LENSES, 12 VOLT BULB INCLUDED.**

**FIG. 972 - CERTIFIED FOR USE ON SAIL OR POWER DRIVEN VESSELS UNDER 12 METERS (39.4 FT.) IN LENGTH.**



### ORDERING INFORMATION

O.D. Length Inches	Vertical Height Inches	Dealer Pkg. - 5 Cards 1 Pc. per Card	OEM Bulk Pkg. 25 Pcs.	Screw Size	Weight Ounces
2-3/8	7/8	972 DP CHR	972 000 CHR	4	3



**FIG. 972**

Spare Bulbs (2 per card), Cat. No. 71 DP CLR.  
Spare Base with Socket Assembly, Cat. No. 135.  
Spare Lens Set, Old Style Open Top (1 - Red & 1-Grn), Cat. No. 296 DP LNS.  
Spare Lens Set, New Style Closed Top (1 - Red & 1-Grn), Cat. No. 297 DP LNS.

**FIG. 904 - CERTIFIED FOR USE ON SAIL OR POWER DRIVEN VESSELS UNDER 12 METERS (39.4 FT.) IN LENGTH.**



### ORDERING INFORMATION

Length Inches	Width Inches	Vertical Height Inches	Dealer Pkg. - 5 Cards 1 Pc. per Card	OEM Bulk Pkg. 10 Pcs.	Screw Size	Weight Ounces
4-1/4	2-1/8	7/8	904 DP CHR	904 000 CHR	4	3-1/2



**FIG. 904**

Spare Bulbs (2 per card), Cat. No. 71 DP CLR. Spare Lens Set (1-Red & 1-Green), Cat. No. 296 DP LNS.  
Spare Base with Socket Assembly, Cat. No. 107.

**FIG. 1218 - CERTIFIED FOR USE ON POWER DRIVEN VESSELS UNDER 12 METERS (39.4 FT.) IN LENGTH.**



### ORDERING INFORMATION

Dimensions Base Inches	Vertical Height Inches	I.D. Socket Inches	Dealer Pkg. - 5 Cards 1 Pc. per Card	Screw Size	Weight Ounces
6-3/4 x 3-7/8	1-5/8	3/4	1218 DP CHR	8	12



**FIG. 1218**

Spare Bulbs (2 per card), Cat. No. 71 DP CLR. Spare Lens Set (1-Red & 1-Green), Cat. No. 259 DPA LNS.  
Spare Socket Assembly, Cat. No. 1218 DP 99A.

**NOTE: To Use THE LIGHTS ON THIS PAGE IN A 24 VOLT SYSTEM, ORDER REPLACEMENT BULBS (2 PER CARD) CAT. NO. 72 DP1 CLR.**

NAVIGATION LIGHTS FOR VESSELS UNDER 20 METERS

## REMOVABLE BI-COLOR LIGHTS

PATENT No. 4,500,947

**RED & GREEN LENSES, 12 VOLT BULB INCLUDED.**

**FIGS. 1211/1212/1296 - CERTIFIED FOR USE ON SAIL OR POWER DRIVEN VESSELS UNDER 12 METERS (39.4 FT.) IN LENGTH.**

**FIGS. 1421/1422 - CERTIFIED FOR USE ON POWER DRIVEN VESSELS UNDER 20 METERS (65.6 FT.) IN LENGTH.**



1421/1422

- CONSTRUCTION:**
- \* **BLACK PLASTIC TOP**
  - \* **3/4 INCH DIAMETER ANODIZED ALUMINUM TUBES**
  - \* **WATERPROOF COVER OR WATER RESISTANT SLIDE COVER FOR BASE**
  - \* **DECK ILLUMINATING UTILITY LIGHT**
  - \* **STOW-A-WAY PLUG-IN TYPE POLES**

**FIGS. 1211, 1296 & 1421**

- \* **CHROME PLATED BRASS AND BLACK PLASTIC BASE**

**FIGS. 1212 & 1422**

- \* **CHROME PLATED ZINC ALLOY BASE**
- \* **POLE HAS A 5° ANGLE**



### ORDERING INFORMATION

Vertical Height Inches	Dimensions Base Inches	Dealer Pkg. 5 Cards 1 Pc. per Card	OEM Bulk Pkg. 50 Pcs.	Screw Size	Weight Ounces
10	2-1/4 O.D.	1211 DP CHR	1211 000 CHR	8	8
10-7/16	3-3/4 x 1-3/4	1212 DP CHR	1212 000 CHR	8	8
10	3-1/2 x 1-1/2	1296 DP CHR	1296 000 CHR	8	8
9-9/16	2-1/4 O.D.	1421 DP CHR	1421 000 CHR	8	8
9-7/8	3-3/4 x 1-3/4	1422 DP CHR	1422 000 CHR	8	8

Spare Bulbs for Bi-Color Section (2 per card), Cat. No. 71 DP CLR.  
 Spare Bulb for Utility Light, Cat. No. 64 000 CLR.  
 Spare Lens Set Figs. 1211, 1212 & 1296 (1-Red & 1-Green), Cat. No. 268 DP LNS.  
 Spare Lens Set Figs. 1421 & 1422 (1-Red & 1-Green), Cat. No. 241 DP LNS.  
 Spare Mounting Bases See Page #36.  
 Spare Replacement Pole Light for Figs. 1211 & 1296, Cat. No. 1211 DP 99A.  
 Spare Replacement Pole Light for Fig. 1212, Cat. No. 1212 DP 99A.  
 Spare Replacement Pole Light for Fig. 1421, Cat. No. 1421 DP 99A.  
 Spare Replacement Pole Light for Fig. 1422, Cat. No. 1422 DP 99A.



**FIG. 1421**  
0° Rake

**FIG. 1422**  
5° Rake

### Featuring

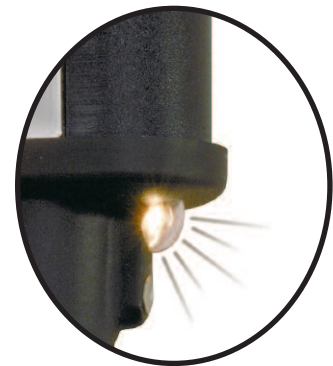

**DECK ILLUMINATING UTILITY LIGHT**  
 in the Rear Section of the Top,  
 Controlled by a Switch Located  
 on the Top Cover.

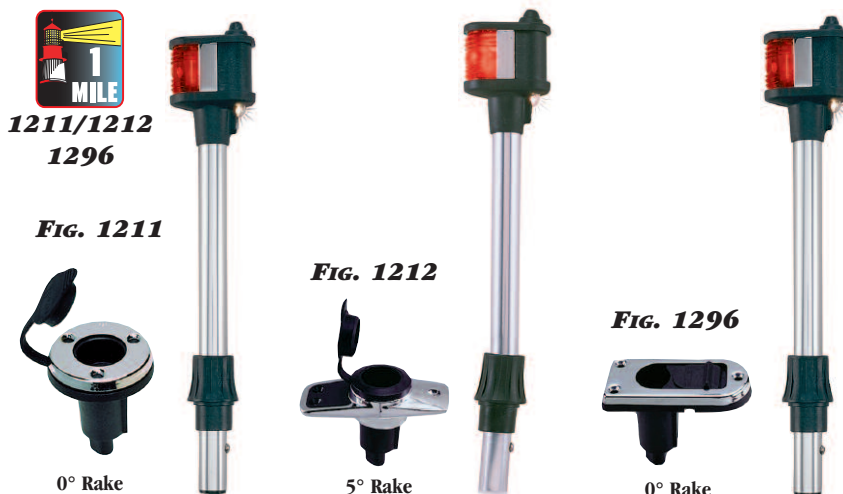

**1211/1212**  
**1296**

**FIG. 1211**

**FIG. 1212**

**FIG. 1296**

0° Rake

5° Rake

0° Rake



**NOTE: TO USE THE LIGHTS ON THIS PAGE IN A 24 VOLT SYSTEM, ORDER REPLACEMENT BULBS (2 PER CARD) CAT. No. 72 DP1 CLR.**

NAVIGATION LIGHTS FOR VESSELS UNDER 20 METERS

## REMOVABLE BI-COLOR LIGHT

PATENT No. 4,500,947

**RED AND GREEN LENSES, 12 VOLT BULB INCLUDED.**

**FIG. 1612 - CERTIFIED FOR USE ON SAIL OR POWER DRIVEN VESSELS UNDER 12 METERS (39.4 FT.) IN LENGTH.**



Fig. 1612



**CONSTRUCTION:**

- \* **BLACK PLASTIC TOP**
- \* **CHROME PLATED BRASS AND BLACK PLASTIC BASE**
- \* **3/4 INCH DIAMETER ANODIZED ALUMINUM TUBE AND LOCKING COLLAR**
- \* **WATERPROOF COVER FOR BASE**



**ORDERING INFORMATION**

Vertical Height Inches	O.D. Base Inches	Dealer Pkg. - 5 Cards 1 Pc. per Card	OEM Bulk Pkg. 50 Pcs.	Screw Size	Weight Ounces
9-13/16	2-1/4	1612 DP BLK	1612 000 BLK	8	7

Spare Bulbs (2 per card), Cat. No. 71 DP CLR. Spare Replacement Pole Light Cat. No. 1612 DP 99A.  
Spare Mounting Base, Cat. No. 1045 P00 DP. Spare Lens Set For Fig. 1612 (1-Red & 1-Green), Cat. No. 283 DPA LNS.

## TRI-COLOR LIGHT



BI-COLOR



STERN

**FIG. 1201 - CERTIFIED FOR USE ON VESSELS UNDER SAIL ALONE UNDER 12 METERS (39.4 FT.) IN LENGTH.**



FIG. 1201



**CONSTRUCTION:**

- \* **BLACK PLASTIC AND CHROME PLATED ZINC ALLOY TOP**
- \* **BLACK PLASTIC BASE**



**ORDERING INFORMATION**

Vertical Height Inches	Dimensions Base Inches	Dealer Pkg. - 5 Cards 1 Pc. per Card	Screw Size	Weight Ounces
3-1/4	1 x 2-5/8	1201 DP BLK	8	7

Spare Bi-Color Lens Set (1-Red & 1-Green), Cat. No. 268 DP LNS. Spare Bulbs (2 per card), Cat. No. 71 DP CLR.  
Spare White Lenses (2 per card), Cat. No. 278 DP WHT. Spare Top Cap with Screw, Cat. No. 1158 DP BLK.

**NOTE: TO USE THE LIGHTS ON THIS PAGE IN A 24 VOLT SYSTEM, ORDER REPLACEMENT BULBS (2 PER CARD) CAT. NO. 72 DP1 CLR.**

## L.E.D. SIDE LIGHTS

**FIG. 601 - CERTIFIED FOR USE ON POWER DRIVEN VESSELS UNDER 12 METERS (39.4 FT.) IN LENGTH.**



FIG. 601



FIG. 602

**FIG. 602 - CERTIFIED FOR USE ON POWER DRIVEN VESSELS UNDER 20 METERS (65.6 FT.) IN LENGTH.**

### CONSTRUCTION OPTIONS:

- \* CHROME PLATED BRONZE
- \* WHITE EPOXY COATED BRONZE
- \* 12 OR 24 VOLT
- \* 1 MILE OR 2 MILE VISIBILITY
- \* VERTICAL MOUNT
- \* LOW PROFILE - SMALL SIZE
- \* USES 1/10<sup>TH</sup> OF THE ENERGY DRAW OF STANDARD LIGHTS
- \* LOW HEAT
- \* LONG LIFE (100,000 HOURS)
- \* WATER RESISTANT

**NEW  
PRODUCT**



FIGS. 601/602 WHITE

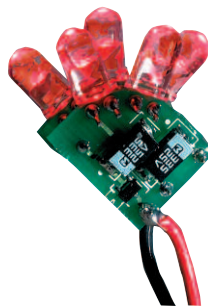

FIG. 601/602 CHROME



### ORDERING INFORMATION

Finish	Voltage	Length Inches	Width Inches	Projection Overall Inches	Dealer Pkg. 1 Card 1 Pair per Card	OEM Bulk Package 1 Pair	Screw Size	Weight Ounces
<b>1 Mile Visibility</b>								
Chrome	12	3-1/4	2	1-1/8	601 DP1 CHR	601 001CHR	8	3
White	12	3-1/4	2	1-1/8	601 DP1 WHT	601 001CHR	8	3
<b>2 Mile Visibility</b>								
Chrome	12	3-1/4	2	1-1/8	602 DP1 CHR	602 001CHR	8	3
White	12	3-1/4	2	1-1/8	602 DP1 WHT	602 001CHR	8	3
Chrome	24	3-1/4	2	1-1/8	602 DP2 CHR	602 002CHR	8	3
White	24	3-1/4	2	1-1/8	602 DP2 WHT	602 002CHR	8	3



## VERTICAL MOUNT SIDE LIGHTS

RED AND GREEN LENSES, 12 VOLT BULBS INCLUDED.



**FIG. 254**  
**CHROME**

**FIG. 254**  
**BLACK**



**FIG. 254**  
**WHITE**

**FIG. 254 - CERTIFIED FOR USE ON POWER DRIVEN VESSELS UNDER 20 METERS (65.6 FT.) IN LENGTH.**

**CONSTRUCTION OPTIONS:**

- \* CHROME PLATED BRONZE WITH BLACK PLASTIC BASE
- \* ALL BLACK PLASTIC
- \* ALL WHITE PLASTIC



**ORDERING INFORMATION**

Fig. 254 Finish	Length Inches	Width Inches	Projection Overall Inches	Dealer Pkg. 5 Cards 1 Pair per Card	OEM Bulk Pkg. 10 Pair	Screw Size	Weight Per Pair Ounces
Chrome	3-1/2	2-1/4	7/8	254 M DP1	254 M 12V	8	6
Black	3-1/2	2-1/4	7/8	254 B DP1	254 B 12V	8	6
White	3-1/2	2-1/4	7/8	254 W DP1	254 W 12V	8	6

Fig. 254 Green Spare Lens Only, Cat. No. 277 DPG LNS  
 Fig. 254 Red Spare Lens Only, Cat. No. 277 DPR LNS.  
 Fig. 254 Spare Base with Socket Assembly, Cat. No. 254 BLK/WHT 99A.  
 12 Volt Spare Bulbs for Fig. 254 (2 per card), Cat. No. 71 DP8 CLR.



**FIG. 955**

**FIG. 955 - FOR USE ON SAIL OR POWER DRIVEN VESSELS UNDER 12 METERS (39.4 FT.) IN LENGTH.**

**CONSTRUCTION:**

- \* CHROME PLATED BRASS TOP WITH BLACK PLASTIC BASE



**ORDERING INFORMATION**

Length Inches	Width Inches	Projection Overall Inches	Dealer Pkg. 5 Cards 1 Pair per Card	OEM Bulk Pkg. 10 Pair	Screw Size	Weight Per Pair Ounces
4-1/4	2-3/8	5/8	955 DP CHR	955 000 CHR	4	7

Green Side Light Only, Cat. No. 955 G00 CHR. Spare Lens Set (1-Red & 1-Green), Cat. No. 260 DP LNS.  
 Red Side Light Only, Cat. No. 955 R00 CHR. Spare Base with Socket Assembly, Cat. No. 955 000 99A.  
 Spare Bulbs (2 per card), Cat. No. 71 DP CLR.



**FIG. 1264**

**FIG. 1264 - FOR USE ON POWER DRIVEN VESSELS UNDER 12 METERS (39.4 FT.) IN LENGTH.**

**CONSTRUCTION:**

- \* CHROME PLATED ZINC ALLOY WITH BLACK VINYL MOUNTING GASKET



**ORDERING INFORMATION**

Length Inches	Width Inches	Projection Overall Inches	Dealer Pkg. - 5 Cards 1 Pair per Card	Screw Size	Weight Per Pair Pounds
5-1/2	3-1/8	1-3/4	1264 DP CHR	8	1

Green Side Light Only, Cat. No. 1264 G00 CHR. Spare Lens Set (1-Red & 1-Green), Cat. No. 1264 DP LNS.  
 Red Side Light Only, Cat. No. 1264 R00 CHR. Spare Socket Assembly, Cat. No. 1264 DP 99A.  
 Spare Bulbs (2 per card), Cat. No. 71 DP CLR.

**NOTE: To Use Fig. Nos. 955 & 1264 IN A 24 VOLT SYSTEM, ORDER REPLACEMENT BULBS (2 PER CARD) CAT. No. 72 DP1 CLR.**



## VERTICAL MOUNT SIDE LIGHTS

RED AND GREEN LENSES, 12 VOLT OR 24 VOLT BULBS INCLUDED.



**FIG. 120 - CERTIFIED FOR USE ON SAIL OR POWER DRIVEN VESSELS UNDER 12 METERS (39.4 FT.) IN LENGTH (12 VOLTS).**



**FIG. 120**



**FIG. 170 - CERTIFIED FOR USE ON SAIL OR POWER DRIVEN VESSELS UNDER 20 METERS (65.6 FT.) IN LENGTH (12 OR 24 VOLTS).**



**FIG. 170**

**CONSTRUCTION OPTIONS:**

- \* **CHROME PLATED BRASS TOP WITH BLACK PLASTIC BASE**
- \* **ALL BLACK PLASTIC**
- \* **ALL WHITE PLASTIC**



**Figs. 120 MSD & 170 MSD**



**Figs. 120 BSD & 170 BSD**



**Figs. 120 WSD & 170 WSD**



**Figs. 120 MP & 170 MP**



**Figs. 120 BP & 170 BP**

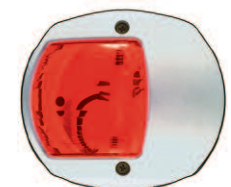

**Figs. 120 WP & 170 WP**

**DIMENSIONS**

Height Overall Inches	Projection Overall Inches	Width Inches	Screw Size	Weight Ounces
3-5/8	2-1/2	4-1/8	10	5

**FIG. 120 ORDERING INFORMATION - 12 VOLT**

Description	Dealer Pkg. 5 - Cards 1 Pc. per Card	OEM Bulk Pkg. 10 Pcs.
<b>Chrome</b>		
Red Side Light	120 MP DP1	120 MP 12V
Green Side Light	120 MSD DP1	120 MSD 12V
<b>Black Plastic</b>		
Red Side Light	120 BP DP1	120 BP 12V
Green Side Light	120 BSD DP1	120 BSD 12V
<b>White Plastic</b>		
Red Side Light	120 WP DP1	120 WP 12V
Green Side Light	120 WSD DP1	120 WSD 12V

**FIG. 170 ORDERING INFORMATION - 12 VOLT**

Description	Dealer Pkg. 5 - Cards 1 Pc. per Card	Std Pkg.- 1 Pc. OEM Pkg. - 10 Pcs.
<b>Chrome</b>		
Red Side Light	170 MP DP1	170 MP 12V
Green Side Light	170 MSD DP1	170 MSD 12V
<b>Black Plastic</b>		
Red Side Light	170 BP DP1	170 BP 12V
Green Side Light	170 BSD DP1	170 BSD 12V
<b>White Plastic</b>		
Red Side Light	170 WP DP1	170 WP 12V
Green Side Light	170 WSD DP1	170 WSD 12V

**FIG. 170 ORDERING INFORMATION - 24 VOLT**

Description	Dealer Pkg. 5 - Cards 1 Pc. per Card	Std Pkg.- 1 Pc. OEM Pkg. - 10 Pcs.
<b>Chrome</b>		
Red Side Light	170 MP DP2	170 MP 24V
Green Side Light	170 MSD DP2	170 MSD 24V
<b>Black Plastic</b>		
Red Side Light	170 BP DP2	170 BP 24V
Green Side Light	170 BSD DP2	170 BSD 24V
<b>White Plastic</b>		
Red Side Light	170 WP DP2	170 WP 24V
Green Side Light	170 WSD DP2	170 WSD 24V

Note: See Pages 28 & 29 for Complete Series, 24 Volt Options & Spare Parts Ordering Information.

## HORIZONTAL MOUNT SIDE LIGHTS

RED AND GREEN LENSES, 12 VOLT BULBS INCLUDED.



FIG. 228

**FIG. 228 - CERTIFIED FOR USE ON POWER DRIVEN VESSELS UNDER 20 METERS (65.6 FT.) IN LENGTH.**

**CONSTRUCTION:**

- \* CHROME PLATED ZINC ALLOY TOP WITH BLACK PLASTIC BASE



**ORDERING INFORMATION**

Length Inches	Width Inches	Vertical Height Inches	Dealer Pkg. 5 Cards 1 Pair per Card	OEM Bulk Pkg. 25 Pairs.	Screw Size	Weight Ounces
3-1/4	2-5/16	5/8	228 DP CHR	228 000 CHR	8	3

Spare Red Lens, Cat. No. 228 DPR LNS. Spare Green Lens, Cat. No. 228 DPG LNS.  
Spare Black Base with Socket Assembly, Cat. No. 227 000 99A. Spare Bulbs (2 per card), Cat. No. 71 DP CLR.



FIG. 253 CHROME

**FIG. 253 - CERTIFIED FOR USE ON POWER DRIVEN VESSELS UNDER 20 METERS (65.6 FT.) IN LENGTH.**

**CONSTRUCTION OPTIONS:**

- \* CHROME PLATED BRONZE TOP WITH BLACK PLASTIC BASE
- \* ALL BLACK PLASTIC
- \* ALL WHITE PLASTIC



FIG. 253 BLACK



FIG. 253 WHITE



**ORDERING INFORMATION**

Fig. 253 Finish	Length Inches	Width Inches	Vertical Height Inches	Dealer Pkg. 5 Cards 1 Pair per Card	OEM Bulk Pkg. 10 Pair	Screw Size	Weight Per Pair Ounces
Chrome	3-1/2	2-1/4	13/16	253 M DP1	253 M 12V	8	6
Black	3-1/2	2-1/4	13/16	253 B DP1	253 B 12V	8	6
White	3-1/2	2-1/4	13/16	253 W DP1	253 W 12V	8	6

Fig. 253 Green Spare Lens Only, Cat. No. 273 DPG LNS.  
Fig. 253 Red Spare Lens Only, Cat. No. 273 DPR LNS.  
Fig. 253 Spare Base with Socket Assembly, Cat. No. 114 000 BLK/WHT.  
Spare Bulbs for Fig. 253 (2 per card), Cat. No. 71 DP CLR.



NOTE: TO USE THE LIGHTS ON THIS PAGE IN A 24 VOLT SYSTEM, ORDER REPLACEMENT BULBS (2 PER CARD) CAT. NO. 72 DP1 CLR.

## HORIZONTAL MOUNT SIDE LIGHTS

RED AND GREEN LENSES, 12 VOLT BULB INCLUDED.

**FIG. 963 - CERTIFIED FOR USE ON SAIL OR POWER DRIVEN VESSELS UNDER 12 METERS (39.4 FT.) IN LENGTH.**

**CONSTRUCTION:**

\* **CHROME PLATED BRASS TOP WITH BLACK PLASTIC BASE**



**ORDERING INFORMATION**

O.D. Base Inches	Vertical Height Inches	Dealer Pkg. - 5 Cards 1 Pair per Card	OEM Bulk Pkg. 10 Pair	Screw Size	Weight Per Pair Ounces
2-3/8	7/8	963 DP CHR	963 000 CHR	4	6

Green Side Light Only, Cat. No. 963 G00 CHR. Spare Lens Set, Old Style Open Top (1-Red & 1-Grn), Cat. No. 281 DPA LNS.  
 Red Side Light Only, Cat. No. 963 R00 CHR. Spare Lens Set, New Style Closed Top (1-Red & 1-Grn), Cat. No. 295 DP LNS.  
 Spare Bulbs (2 per card), Cat. No. 71 DP CLR. Spare Base with Socket Assembly, Cat. No. 135.



**FIG. 963**



**FIGS. 1601/1602 - CERTIFIED FOR USE ON SAIL OR POWER DRIVEN VESSELS UNDER 12 METERS (39.4 FT.) IN LENGTH.**

**CONSTRUCTION:**

\* **BLACK PLASTIC**

**FIG. 1601 - NORMAL "BASE-DOWN" MOUNT**

**FIG. 1602 - INVERTED "BASE-UP" MOUNT**

**GREAT FOR PONTOON BOATS**



**ORDERING INFORMATION**

Vertical Height Inches	Height Overall Inches	Dimensions Base Inches	Dealer Pkg. 5 Cards 1 Pair per Card	OEM Bulk Pkg. 25 Pair	Screw Size	Weight Ounces
1-1/4	1-7/8	1-1/8 x 3	1601 DP BLK	1601 000 BLK	8	2-1/4
1-1/4	1-7/8	1-1/8 x 3	1602 DP BLK	1602 000 BLK	8	2-1/4

Spare Bulbs (2 per card), Cat. No. 71 DP CLR. Red Spare Lens Only, Cat. No. 298 DPR LNS.  
 Spare Base with Socket Assembly, Cat. No. 139 000 BLK. Green Spare Lens Only, Cat. No. 298 DPG LNS.



**FIG. 1601**



**FIG. 1602**

**FIG. 915 - CERTIFIED FOR USE ON SAIL OR POWER DRIVEN VESSELS UNDER 12 METERS (39.4 FT.) IN LENGTH.**

**CONSTRUCTION:**

\* **CHROME PLATED BRASS TOP WITH BLACK PLASTIC BASE**



**ORDERING INFORMATION**

Length Inches	Width Inches	Vertical Height Inches	Dealer Pkg. 5 Cards 1 Pair per Card	OEM Bulk Pkg. 10 Pair	Screw Size	Weight Per Pair Ounces
4-1/4	2-3/8	7/8	915 DP CHR	915 000 CHR	4	7

Green Side Light Only, Cat. No. 915 G00 CHR. Spare Lens Set, Old Style Open Top (1-Red & 1-Green), Cat. No. 281 DPA LNS.  
 Red Side Light Only, Cat. No. 915 R00 CHR. Spare Lens Set, New Style Closed Top (1-Red & 1-Green), Cat. No. 295 DP LNS.  
 Spare Bulbs (2 per card), Cat. No. 71 DP CLR. Spare Base with Socket Assembly, Cat. No. 107.



**FIG. 915**



**NOTE: TO USE THE LIGHTS ON THIS PAGE IN A 24 VOLT SYSTEM, ORDER REPLACEMENT BULBS (2 PER CARD) CAT. NO. 72 DP1 CLR.**

NAVIGATION LIGHTS FOR VESSELS UNDER 20 METERS

## HORIZONTAL & VERTICAL MOUNT STERN LIGHTS

CLEAR LENSES, 12 VOLT BULB INCLUDED.



**Fig. 945**  
Vertical Mount

**FIG. 945/965 - FOR USE ON SAIL OR POWER DRIVEN VESSELS UNDER 20 METERS (65.6 FT.) IN LENGTH.**

**CONSTRUCTION:**

**\* CHROME PLATED BRASS TOP WITH BLACK PLASTIC BASE**



**Fig. 965**  
Horizontal Mount



**ORDERING INFORMATION**

	O.D. Base Inches	Vertical Height Inches	Dealer Pkg. - 5 Cards 1 Pc. per Card	OEM Bulk Pkg. 25 Pcs.	Screw Size	Weight Ounces
Vertical	2-3/8	7/8	945 DP CHR	945 000 CHR	4	3
Horizontal	2-3/8	3/4	965 DP CHR	965 000 CHR	4	3

Spare Bulbs (2 per card), Cat. No. 71 DP CLR. Spare Base and Socket Assembly For Fig. 945, Cat. No. 945 DP 99A.  
Spare Lens For Fig. No. 945, Cat. No. 74 DP WHT. Spare Old Style (Open Top) Lens For Fig. No. 965, Cat. No. 281 DPA WHT.  
Spare Base and Socket Assembly For Fig. 965, Cat. No. 135. Spare New Style (Closed Top) Lens For Fig. No. 965, Cat. No. 295 DP WHT.

**NOTE: TO USE THE ABOVE LIGHTS IN A 24 VOLT SYSTEM, ORDER REPLACEMENT BULBS (2 PER CARD) CAT. NO. 72 DP1 CLR.**



**Fig. 939**  
Vertical Mt.

**FIG. 939 - FOR USE ON SAIL OR POWER DRIVEN VESSELS UNDER 20 METERS (65.6 FT.) IN LENGTH.**

**CONSTRUCTION:**

**\* CHROME PLATED BRASS TOP WITH BLACK PLASTIC BASE**  
**\* FLUSH MOUNT**



**ORDERING INFORMATION**

Voltage	Dimensions Inches	Depth Inches	Dealer Pkg. - 5 Cards 1 Pc. per Card	OEM Bulk Pkg. 20 Pcs.	Screw Size	Weight Ounces
12	5-3/16 x 3-3/8	1-1/2	939 DP1 12V	939 001 12V	8	4
32	5-3/16 x 3-3/8	1-1/2	939 DP3 32V	-----	8	4

Spare 12 Volt Bulbs (2 per card), Cat. No. 70 DP0 CLR. Spare 12 Volt Socket Assembly, Cat. No. 939 DP1 99A.  
Spare 32 Volt Bulbs (2 per card), Cat. No. 70 DP2 CLR. Spare 32 Volt Socket Assembly, Cat. No. 939 003 99A.  
Spare Lens with Gasket, Cat. No. 284 DP CLR. Spare Mounting Flange, Cat. No. 939 000 99C.



**Fig. 946**  
**CHROME**  
Vertical Mount

**FIG. 946 - FOR USE ON SAIL OR POWER DRIVEN VESSELS UNDER 20 METERS (65.6 FT.) IN LENGTH.**

**CONSTRUCTION:**

**\* FLUSH MOUNT**  
**\* CHROME PLATED BRASS BEZEL WITH BLACK PLASTIC BASE**  
**\* WHITE PLASTIC BEZEL WITH BLACK PLASTIC BASE**



**ORDERING INFORMATION**

Finish	Voltage	O.D. Inches	Depth Inches	Dealer Pkg. - 5 Cards 1 Pc. per Card	OEM Bulk Pkg. 25 Pcs.	Screw Size	Weight Ounces
Chrome	12	3	1	946 DP1 12V	946 001 12V	8	4
Chrome	32	3	1	946 DP3 32V	-----	8	4
White	12	3	1	946 DP1 WHT	946 001 WHT	8	4
White	32	3	1	946 DP3 WHT	946 003 WHT	8	4

Spare 12 Volt Bulbs (2 per card), Cat. No. 70 DP0 CLR. Spare 12 Volt Socket Assembly, Cat. No. 946 DP1 99B.  
Spare 32 Volt Bulbs (2 per card), Cat. No. 70 DP2 CLR. Spare 32 Volt Socket Assembly, Cat. No. 946 003 99B.  
Spare Lens with Gasket, Cat. No. 946 DP 99A. Spare Mounting Flange, Cat. No. 946 000 99C.



**Fig. 946**  
**WHITE**  
Vertical Mount



## VERTICAL MOUNT STERN LIGHTS

CLEAR LENS, COMPLETE WITH 12 VOLT OR 24 VOLT BULB WHERE SPECIFIED.

**FIGS. 120/170 - FOR USE ON SAIL OR POWER DRIVEN VESSELS UNDER 20 METERS (65.6 FT.) IN LENGTH.**



**CONSTRUCTION OPTIONS:**

- \* CHROME PLATED BRASS TOP WITH BLACK PLASTIC BASE
- \* ALL BLACK PLASTIC
- \* ALL WHITE PLASTIC



**ORDERING INFORMATION - FOR 12 VOLT LIGHTS**

Finish	Height Overall Inches	Projection Overall Inches	Width Inches	Dealer Pkg. 5 Cards 1 Pc. per Card	OEM Bulk Pkg. 10 Pcs.	Screw Size	Weight Ounces
<b>Fig. 120</b>							
Chrome	3-5/8	2-1/2	4-1/8	120 MSN DP1	120 MSN 12V	10	5
Black	3-5/8	2-1/2	4-1/8	120 BSN DP1	120 BSN 12V	10	5
White	3-5/8	2-1/2	4-1/8	120 WSN DP1	120 WSN 12V	10	5
<b>Fig. 170</b>							
Chrome	3-5/8	2-1/2	4-1/8	170 MSN DP1	170 MSN 12V	10	5
Black	3-5/8	2-1/2	4-1/8	170 BSN DP1	170 BSN 12V	10	5
White	3-5/8	2-1/2	4-1/8	170 WSN DP1	170 WSN 12V	10	5



**FIGS. 120 MSN & 170 MSN**



**FIGS. 120 BSN & 170 BSN**



**FIGS. 120 WSN & 170 WSN**



**ORDERING INFORMATION - FOR 24 VOLT LIGHTS**

Finish	Height Overall Inches	Projection Overall Inches	Width Inches	Dealer Pkg. 5 Cards 1 Pc. per Card	OEM Bulk Pkg. 10 Pcs.	Screw Size	Weight Ounces
Chrome	3-5/8	2-1/2	4-1/8	170 MSN DP2	170 MSN 24V	10	5
Black	3-5/8	2-1/2	4-1/8	170 BSN DP2	170 BSN 24V	10	5
White	3-5/8	2-1/2	4-1/8	170 WSN DP2	170 WSN 24V	10	5

NOTE: See Pages 28 & 29 for Complete Series, 24 Volt Options and Spare Parts Ordering Information.



**FIG. 1332 - FOR USE ON SAIL OR POWER DRIVEN VESSELS UNDER 20 METERS (65.6 FT.) IN LENGTH.**

**CONSTRUCTION:**

- \* CHROME PLATED ZINC ALLOY WITH BLACK PLASTIC BASE



**ORDERING INFORMATION - FOR 12 VOLT LIGHTS**

Length Inches	Width Inches	Dealer Pkg. - 5 Cards 1 Pc. per Card	OEM Bulk Pkg. 50 Pcs.	Screw Size	Weight Ounces
3-3/4	1-1/2	1332 DP CHR	1332 000 CHR	4	4

Spare 12V Bulbs (2 per card), Cat. No. 71 DP CLR. Spare Lenses (2 per card) Cat. No. 278 DP WHT.



**FIG. 1332**



NOTE: TO USE THIS LIGHT IN A 24 VOLT SYSTEM, ORDER REPLACEMENT BULBS (2 PER CARD) CAT. NO. 72 DP1 CLR

## VERTICAL SURFACE MOUNT MASTHEAD LIGHTS

CLEAR LENS, COMPLETE WITH 12 VOLT OR 24 VOLT BULB WHERE SPECIFIED.



FIG. 120



FIG. 170

**FIG. 120 - FOR USE ON SAIL OR POWER DRIVEN VESSELS UNDER 12 METERS (39.4 FT.) IN LENGTH.**

**FIG. 170 - FOR USE ON SAIL OR POWER DRIVEN VESSELS UNDER 20 METERS (65.6 FT.) IN LENGTH.**



**Figs. 120 MM & 170 MM**



**Figs. 120 BM & 170 BM**



**Figs. 120 WM & 170 WM**



**CONSTRUCTION OPTIONS:**

- \* CHROME PLATED BRASS TOP WITH BLACK PLASTIC BASE
- \* ALL BLACK PLASTIC
- \* ALL WHITE PLASTIC



**ORDERING INFORMATION - FOR 12 VOLT LIGHTS**

Finish	Height Overall	Projection Overall	Width	Dealer Pkg. 5 Cards	OEM Bulk Pkg. 10 Pcs.	Screw Size	Weight Ounces
	Inches	Inches	Inches	1 Pc. per Card			
<b>Fig. 120</b>							
Chrome	3-5/8	2-1/2	4-1/8	120 MM DP1	120 MM 12V	10	5
Black	3-5/8	2-1/2	4-1/8	120 BM DP1	120 BM 12V	10	5
White	3-5/8	2-1/2	4-1/8	120 WM DP1	120 WM 12V	10	5
<b>Fig. 170</b>							
Chrome	3-5/8	2-1/2	4-1/8	170 MM DP1	170 MM 12V	10	5
Black	3-5/8	2-1/2	4-1/8	170 BM DP1	170 BM 12V	10	5
White	3-5/8	2-1/2	4-1/8	170 WM DP1	170 WM 12V	10	5

**ORDERING INFORMATION - FOR 24 VOLT LIGHTS**

Finish	Height Overall	Projection Overall	Width	Dealer Pkg. 5 Cards	OEM Bulk Pkg. 10 Pcs.	Screw Size	Weight Ounces
	Inches	Inches	Inches	1 Pc. per Card			
Chrome	3-5/8	2-1/2	4-1/8	170 MM DP2	170 MM 24V	10	5
Black	3-5/8	2-1/2	4-1/8	170 BM DP2	170 BM 24V	10	5
White	3-5/8	2-1/2	4-1/8	170 WM DP2	170 WM 24V	10	5

NOTE: See Pages 28 & 29 for Complete Series, 24 Volt Options and Spare Parts Ordering Information.

## COMBINATION MASTHEAD DECK SPREADER LIGHT



FIG. 120 BMD



FIG. 170 BMD

**FIG. 120 BMD - FOR USE ON SAIL OR POWER DRIVEN VESSELS UNDER 12 METERS (39.4 FT.) IN LENGTH.**

**FIG. 170 BMD - FOR USE ON SAIL OR POWER DRIVEN VESSELS UNDER 20 METERS (65.6 FT.) IN LENGTH.**



**Figs. 120/170 BMD**



**CONSTRUCTION:**

- \* BLACK PLASTIC



**ORDERING INFORMATION - 12 VOLT**

Vertical Height Inches	Projection Overall	Overall Height	Width	Dealer Pkg. 5 Cards	OEM Bulk Pkg. 10 Pcs.	Screw Size	Weight Ounces
	Inches	Inches	Inches	1 Pc. per Card			
4-1/2	4-3/4	7	4-1/8	120 BMD DP1	120 BMD 12V	10	18-1/2
4-1/2	4-3/4	7	4-1/8	170 BMD DP1	170 BMD 12V	10	18-1/2

NOTE: See Page 28 for Spare Parts Ordering Information

## HORIZONTAL & VERTICAL MOUNT MASTHEAD LIGHTS

**CLEAR LENS, 12 VOLT BULB INCLUDED.**

**FIG. 964 - FOR USE ON SAIL OR POWER DRIVEN VESSELS UNDER 12 METERS (39.4 FT.) IN LENGTH.**

**CONSTRUCTION:**

**\* CHROME PLATED BRASS TOP WITH BLACK PLASTIC BASE**



**ORDERING INFORMATION**

O.D. Base Inches	Vertical Height Inches	Dealer Pkg. - 5 Cards 1 Pc. per Card	OEM Bulk Pkg. 25 Pcs.	Screw Size	Weight Ounces
2-3/8	7/8	964 DP CHR	964 000 CHR	4	3

Spare Old Style (Open Top) Lens, Cat. No. 281 DPA WHT.  
Spare New Style (Closed Top) Lens, Cat. No. 295 DP WHT.

Spare Base with Socket Assembly, Cat. No. 135.  
Spare Bulbs (2 per card), Cat. No. 71 DP CLR.



**FIG. 964**  
HORIZONTAL MOUNT



**FIG. 1331 - FOR USE ON SAIL OR POWER DRIVEN VESSELS UNDER 20 METERS (65.6 FT.) IN LENGTH.**

**CONSTRUCTION:**

**\* CHROME PLATED ZINC ALLOY WITH BLACK PLASTIC BASE**



**ORDERING INFORMATION**

Length Inches	Width Inches	Dealer Pkg. - 5 Cards 1 Pc. per Card	OEM Bulk Pkg. 50 Pcs.	Screw Size	Weight Ounces
3-3/4	1-1/2	1331 DP CHR	1331 000 CHR	4	4

Spare Bulbs (2 per card), Cat. No. 71 DP CLR.

Spare Lenses (2 per card), Cat. No. 278 DP WHT.



**FIG. 1331**  
VERTICAL MOUNT



**FIG. 1178 - FOR USE ON VESSELS UNDER 20 METERS (65.6 FT.) IN LENGTH.**

**CONSTRUCTION:**

**\* BLACK PLASTIC AND CHROME PLATED ZINC ALLOY TOP WITH BLACK PLASTIC BASE**



**ORDERING INFORMATION**

Vertical Height Inches	Dimensions Base Inches	Dealer Pkg. - 5 Cards 1 Pc. per Card	OEM Bulk Pkg. 50 Pcs.	Screw Size	Weight Ounces
3-1/4	1 x 2-5/8	1178 DP CHR	1178 000 CHR	8	7

Spare Bulbs (2 per card), Cat. No. 71 DP CLR.  
Spare Top Cap and Screw, Cat. No. 1158 DP BLK.

Spare Lenses (2 per card), Cat. No. 278 DP WHT.



**NOTE: TO USE THE LIGHTS ON THIS PAGE IN A 24 VOLT SYSTEM, ORDER REPLACEMENT BULBS (2 PER CARD) CAT. NO. 72 DP1 CLR.**

NAVIGATION LIGHTS FOR VESSELS UNDER 20 METERS

## COMBINATION MASTHEAD AND WHITE ALL-ROUND LIGHTS

**CLEAR LENSES, TWO 12 VOLT BULBS INCLUDED.**

**FIGS. 1181/1184 - FOR USE ON SAIL OR POWER DRIVEN VESSELS UNDER 20 METERS (65.6 FT.) IN LENGTH.**



**IMPROVED ADJUSTABILITY**

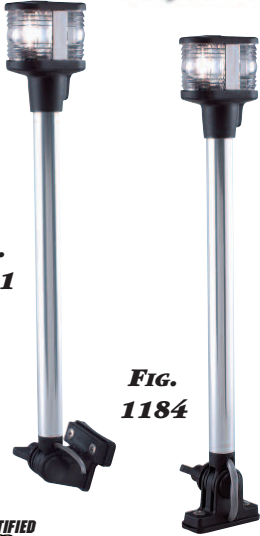

**FIG. 1181**

**FIG. 1184**



- CONSTRUCTION:**
- \* **BLACK PLASTIC AND CHROME PLATED ZINC ALLOY TOP**
  - \* **BLACK PLASTIC BASE**
  - \* **3/4 INCH DIAMETER ANODIZED ALUMINUM TUBES**
  - \* **PLASTIC ADAPTERS FOR FLAT OR "V" TYPE MOUNT, CONTAINS NOTCH FOR THROUGH-BASE WIRING**
  - \* **FOLD-DOWN, ADJUSTABLE ANGLE**

**FIG. 1181 - HORIZONTAL MOUNT**  
**FIG. 1184 - VERTICAL MOUNT**



### ORDERING INFORMATION

Vertical Height Inches	Dimensions Base Inches	Dealer Pkg. - 5 Cards 1 Pc. per Card	OEM Bulk Pkg. 50 Pcs.	Screw Size	Weight Pounds
12-13/16	2 x 1-1/2	1181 DP CHR	1181 000 CHR	8	3/4
12-13/16	2-1/4 x 5/8	1184 DP CHR	1184 000 CHR	8	3/4

For Fig. 1181, Old Style Zinc Bases, Spare Bracket with Knob and End Plug, Cat. No. 1052 DPA CHR.  
For Fig. 1184, Old Style Zinc Bases, Spare Bracket with Knob and End Plug, Cat. No. 1054 DPA CHR.  
For Fig. 1181, New Style Plastic Bases, Spare Bracket with Knob and End Plug, Cat. No. 1052 DPB BLK.  
For Fig. 1184, New Style Plastic Bases, Spare Bracket with Knob and End Plug, Cat. No. 1054 DPB BLK.  
Spare Knob, Cat. No. 1144 A00 BLK.

**NOTE: TO USE THE LIGHTS ABOVE IN A 24 VOLT SYSTEM, ORDER REPLACEMENT BULBS (2 PER CARD) CAT. NO. 72 DP1 CLR.**



**IMPROVED ADJUSTABILITY**

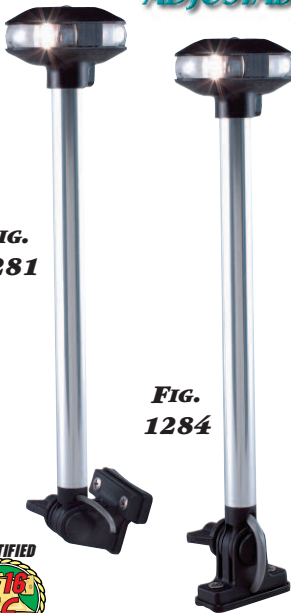

**FIG. 1281**

**FIG. 1284**



**FIGS. 1281/1284 - FOR USE ON POWER DRIVEN VESSELS UNDER 12 METERS (39.4 FT.) IN LENGTH.**

- CONSTRUCTION:**
- \* **REDUCED GLARE DESIGN**
  - \* **BLACK PLASTIC AND CHROME PLATED ZINC ALLOY TOP**
  - \* **BLACK PLASTIC BASE**
  - \* **3/4 INCH DIAMETER ANODIZED ALUMINUM TUBE**
  - \* **PLASTIC ADAPTERS FOR FLAT OR "V" TYPE MOUNT, CONTAINS NOTCH FOR THROUGH-BASE WIRING**
  - \* **FOLD-DOWN, ADJUSTABLE ANGLE**

**FIG. 1281 - HORIZONTAL MOUNT**  
**FIG. 1284 - VERTICAL MOUNT**



### ORDERING INFORMATION

Vertical Height Inches	Dimensions Base Inches	Dealer Pkg. - 5 Cards 1 Pc. per Card	OEM Bulk Pkg. 50 Pcs.	Screw Size	Weight Pounds
12-3/16	2 x 1-1/2	1281 DP CHR	1281 000 CHR	8	3/4
12-3/16	2-1/4 x 5/8	1284 DP CHR	1284 000 CHR	8	3/4

For Fig. 1281, Old Style Zinc Bases, Spare Bracket with Knob and End Plug, Cat. No. 1052 DPA CHR.  
For Fig. 1284, Old Style Zinc Bases, Spare Bracket with Knob and End Plug, Cat. No. 1054 DPA CHR.  
For Fig. 1281, New Style Plastic Bases, Spare Bracket with Knob and End Plug, Cat. No. 1052 DPB BLK.  
For Fig. 1284, New Style Plastic Bases, Spare Bracket with Knob and End Plug, Cat. No. 1054 DPB BLK.  
Spare Knob, Cat. No. 1144 A00 BLK. For Use with Old Style Base Only.

### SPARE PARTS ORDERING INFORMATION

**For Figs. 1181 & 1184**  
Spare Bulbs (2 per card), Cat. No. 71 DP CLR.  
Spare Lenses (2 per card), Cat. No. 278 DP WHT.  
Spare Top Cap with Screw, Cat. No. 1158 DP BLK.

**For Figs. 1281 & 1284**  
Spare Bulbs (2 per card), Cat. No. 338 DP1 CLR.  
Spare Lenses (2 per card), Cat. No. 240 DP LNS.



## COMBINATION MASTHEAD AND WHITE ALL-ROUND LIGHTS

CLEAR LENSES, TWO 12 VOLT BULBS INCLUDED.

**FIGS. 1183, 1196 & 1197 - CERTIFIED FOR USE ON SAIL OR POWER DRIVEN VESSELS UNDER 20 METERS (65.6 FT.) IN LENGTH.**

**CONSTRUCTION:**

- \* **BLACK PLASTIC AND CHROME PLATED ZINC ALLOY TOP**
- \* **BLACK PLASTIC BASE**
- \* **3/4 INCH DIAMETER ANODIZED ALUMINUM TUBE**
- \* **FIGS. 1183 & 1196 - FIXED MOUNT**
- \* **FIG. 1197 - PLUG-IN MOUNT**



**ORDERING INFORMATION**

Vertical Height Inches	Dimensions Base Inches	Dealer Pkg. - 5 Cards 1 Pc. per Card	OEM Bulk Pkg. 50 Pcs.	Screw Size	Weight Ounces
3-3/16	1 x 2-5/8	1183 DP CHR	1183 000 CHR	8	7
5-1/16	1 x 2-5/8	1196 DP1 CHR	1196 001 CHR	8	8
11-1/4	1 x 2-5/8	1196 DP2 CHR	1196 002 CHR	8	8



Fig. 1183



Fig. 1196

Fig. 1197



**ORDERING INFORMATION**

Vertical Height Inches	Length Tubing Inches	Dealer Pkg. - 5 Cards 1 Pc. per Card	OEM Bulk Pkg. 50 Pcs.	Weight Ounces
4	1	1197 DP CHR	1197 000 CHR	7



**NOTE: TO USE THE LIGHTS ABOVE IN A 24 VOLT SYSTEM, ORDER REPLACEMENT BULBS (2 PER CARD) CAT. No. 72 DP1 CLR.**

**FIGS. 1236 & 1283 - CERTIFIED FOR USE ON POWER DRIVEN VESSELS UNDER 12 METERS (39.4 FT.) IN LENGTH.**

**CONSTRUCTION:**

- \* **"REDUCED GLARE" DESIGN**
- \* **BLACK PLASTIC TOPS WITH BLACK PLASTIC BASE**
- \* **3/4 INCH DIAMETER ANODIZED ALUMINUM TUBE**
- \* **FIXED MOUNT**



**ORDERING INFORMATION**

Vertical Height Inches	Dimensions Base Inches	Dealer Pkg. - 5 Cards 1 Pc. per Card	OEM Bulk Pkg. 50 Pcs.	Screw Size	Weight Ounces
4-1/4	1 x 2-5/8	1236 DP1 BLK	1236 001 BLK	8	7
10-1/2	1 x 2-5/8	1236 DP2 BLK	1236 002 BLK	8	8



Fig. 1236



Fig. 1283



**ORDERING INFORMATION**

Vertical Height Inches	Dimensions Base Inches	Dealer Pkg. - 5 Cards 1 Pc. per Card	OEM Bulk Pkg. 50 Pcs.	Screw Size	Weight Ounces
2-1/4	1 x 2-5/8	1283 DP BLK	1283 000 BLK	8	7

**SPARE PARTS ORDERING INFORMATION**

**FOR FIGS. 1183, 1196 & 1197**  
 Spare Bulbs (2 per card), Cat. No. 71 DP CLR.  
 Spare Lenses (2 per card), Cat. No. 278 DP WHT.  
 Spare Top Cap with Screw, Cat. No. 1158 DP BLK.

**FOR FIGS. 1236 & 1283**  
 Spare Bulbs (2 per card), Cat. No. 338 DP1 CLR.  
 Spare Lenses (2 per card), Cat. No. 240 DP LNS.

## COMBINATION MASTHEAD AND WHITE ALL-ROUND LIGHTS

**CLEAR LENSES, TWO 12 VOLT BULBS INCLUDED.**



**FIGS. 1123 & 1124 - CERTIFIED FOR USE ON SAIL OR POWER DRIVEN VESSELS UNDER 20 METERS (65.6 FT.) IN LENGTH.**

**CONSTRUCTION:**

- \* **BLACK PLASTIC AND CHROME PLATED ZINC ALLOY TOP**
- \* **CHROME PLATED ZINC ALLOY MOUNTING BRACKET**
- \* **WATERPROOF COVER FOR MOUNTING BRACKET**
- \* **3/4 INCH DIAMETER ANODIZED ALUMINUM TUBE**
- \* **STOW-A-WAY PLUG-IN TYPE**
- \* **PLASTIC ADAPTERS FOR FLAT OR "V" TYPE 45 DEGREE WINDSHIELDS**

**FIG. 1123**

**FIG. 1123 - HORIZONTAL MOUNT  
FIG. 1124 - VERTICAL MOUNT**

**FIG. 1124**



**ORDERING INFORMATION**

Vertical Height Inches	Dealer Pkg. - 5 Cards 1 Pc. per Card	OEM Bulk Pkg. 50 Pcs.	Screw Size	Weight Pounds
11-1/4	1123 DP1 CHR	1123 001 CHR	8	1
12-1/2	1124 DP1 CHR	1124 001 CHR	8	1
20-1/2	1123 DP2 CHR	1123 002 CHR	8	1-1/8
22	1124 DP2 CHR	1124 002 CHR	8	1-1/8

Spare Bulb (2 per card), Cat. No. 71 DP CLR.  
Spare Lenses (2 per card), Cat. No.278 DP WHT.  
Spare Top Cap with Screw, Cat. No. 1158 DP BLK.  
Spare Replacement Pole for Size No. 1, Cat. No. 1123 DP1 99A

Spare Cap for Base, Cat No. 125 DP BLK.  
Spare Base with Socket Assembly, Cat No. 1123 DP 99A.  
Spare Base with Socket Assembly, Cat No. 1124 DP 99A.  
Spare Replacement Pole for Size No. 2, Cat. No. 1123 DP2 99A



**NOTE: TO USE THE LIGHTS ABOVE IN A 24 VOLT SYSTEM, ORDER REPLACEMENT BULBS (2 PER CARD) CAT. No. 72 DP1 CLR**



**FIGS. 1273 & 1274 - CERTIFIED FOR USE ON SAIL OR POWER DRIVEN VESSELS UNDER 12 METERS (39.4 FT.) IN LENGTH.**

**CONSTRUCTION:**

- \* **"REDUCED GLARE" DESIGN**
- \* **BLACK PLASTIC TOP**
- \* **CHROME PLATED ZINC ALLOY MOUNTING BRACKET**
- \* **WATERPROOF COVER FOR BASE**
- \* **3/4 INCH DIAMETER ANODIZED ALUMINUM TUBES**
- \* **STOW-A-WAY PLUG-IN TYPE**
- \* **PLASTIC ADAPTERS FOR FLAT OR "V" TYPE 45 DEGREE WINDSHIELDS**

**FIG. 1273**

**ORDERING INFORMATION**

Vertical Height Inches	Dealer Pkg. - 5 Cards 1 Pc. per Card	OEM Bulk Pkg. 50 Pcs.	Screw Size	Weight Pounds
10-5/8	1273 DP1 CHR	1273 001 CHR	8	1
11-7/8	1274 DP1 CHR	1274 001 CHR	8	1
20	1273 DP2 CHR	1273 002 CHR	8	1-1/8
21-5/8	1274 DP2 CHR	1274 002 CHR	8	1-1/8

Spare Bulb (2 per card), Cat. No. 338 DP1 CLR.  
Spare Lenses (2 per card), Cat. No. 240 DP LNS.  
Spare Cap for Base, Cat No. 125 DP BLK.  
Spare Replacement Pole for Size No. 1, Cat. No.1273 DP1 99A  
Spare Replacement Pole for Size No. 2, Cat. No. 1273 DP2 99A

Spare Base with Socket Assembly, Cat No. 1123 DP 99A.  
Spare Base with Socket Assembly, Cat No. 1124 DP 99A.



## COMBINATION MASTHEAD AND WHITE ALL-ROUND LIGHTS

CLEAR LENSES, TWO 12 VOLT BULBS INCLUDED.

**FIG. 1125 - CERTIFIED FOR USE ON SAIL OR POWER DRIVEN VESSELS UNDER 20 METERS (65.6 FT.) IN LENGTH.**



**CONSTRUCTION:**

- \* **DECK MOUNT**
- \* **BLACK PLASTIC AND CHROME PLATED ZINC ALLOY TOP**
- \* **CHROME PLATED BRASS BASE**
- \* **WATERPROOF COVER FOR BASE THAT ATTACHES TO DECK MOUNTED RETAINER WHEN LIGHT IS IN PLACE**
- \* **3/4 INCH DIAMETER ANODIZED ALUMINUM TUBE**
- \* **STOW-A-WAY PLUG-IN TYPE**



**Fig. 1125**



**ORDERING INFORMATION**

Vertical Height Inches	Dimensions Base Inches	Dealer Pkg. - 5 Cards 1 Pc. per Card	OEM Bulk Pkg. 50 Pcs.	Screw Size	Weight Pounds
33-7/8	3-3/8 x 2-1/4	1125 DP4 CHR	1125 004 CHR	8	1-1/2

Spare Bulb (2 per card), Cat. No. 71 DP CLR.  
 Spare Lenses (2 per card), Cat. No. 278 DP WHT.  
 Spare Top Cap with Screw, Cat. No. 1158 DP BLK.

Spare Cover for Base, Cat No. 125 DP BLK.  
 Spare Base with Socket Assembly, Cat No. 1125 DP 99A.  
 Spare Replacement Pole Light, Cat. No. 1125 DP4 99A.



**NOTE: TO USE THE LIGHT ABOVE IN A 24 VOLT SYSTEM, ORDER REPLACEMENT BULBS (2 PER CARD) CAT. NO. 72 DP1 CLR.**

**FIG. 455 - CERTIFIED FOR USE ON POWER DRIVEN VESSELS UNDER 20 METERS (65.6 FT.) IN LENGTH.**



**CONSTRUCTION:**

- \* **CLEAR FRESNEL GLOBE**
- \* **BLACK PLASTIC BASE**
- \* **FIXED MOUNT**



**Fig. 455**



**ORDERING INFORMATION**

Vertical Height Inches	O.D. Base Inches	Dealer Pkg. - 5 Cards 1 Pc. per Card	OEM Bulk Pkg. 50 Pcs.	Screw Size	Weight Ounces
4-1/2	2-1/8	455 DP1 CHR	455 001 CHR	8	12
11-7/8	2-1/8	455 DP2 CHR	455 002 CHR	8	16

Spare Bulb (2 per card), Cat. No. 337 011 DP.

Spare Globe, Cat. No. 248 DP CLR.



NAVIGATION LIGHTS FOR VESSELS UNDER 20 METERS

## WHITE ALL-ROUND POLE LIGHTS



**NEW  
PRODUCT**

**FIGS. 1650/1655 - CERTIFIED FOR USE ON POWER DRIVEN VESSELS UNDER 20 METERS (65.6 FT.) IN LENGTH.**

**THE NEXT GENERATION**

**"NEW REDUCED GLARE DESIGN".**

**OFFERS THE FULL BENEFIT OF A "REDUCED GLARE" LIGHT ON THE DECK AND COCKPIT WITH THE ADDED SAFETY OF FULL VISIBILITY ALL POINTS ABOVE THE HORIZON.**



**FIG. 1655**

**CONSTRUCTION:**

- \* **CONTEMPORARY STYLING**
- \* **BLACK PLASTIC, CLEAR FLUTED LENS AND FROSTED GLOBE**
- \* **3/4 INCH DIAMETER ANODIZED TUBE WITH LOCKING COLLAR**
- \* **12 VOLT BULB INCLUDED**
- \* **STOW-A-WAY PLUG-IN TYPE POLE**
- \* **WATER PROOF COVER FOR BASE**

**FIG. 1655 - 5° ANGLED TOP**

- \* **BLACK PLASTIC AND CHROME PLATED BRASS BASE**
- \* **THREADED COLLAR ON POLE**

**FIG. 1650 - STRAIGHT TOP**

- \* **BLACK PLASTIC AND CHROME PLATED BRASS BASE.**

**FIG. 1650**



**ORDERING INFORMATION**

Vertical Height Inches	Base Dimensions Inches	Dealer Pkg. 5 Cards 1 Pc. per Card	OEM Bulk Pkg. 50 Pcs.	Screw Size	Weight Pounds
<b>Fig. 1650</b>					
33	2-1/4 O.D.	1650 DP4 CHR	1650 004 CHR	8	1-3/8
40-5/8	2-1/4 O.D.	1650 DP5 CHR	1650 005 CHR	8	1-3/8
46-3/8	2-1/4 O.D.	1650 DP6 CHR	1650 006 CHR	8	1-1/2
51-7/16	2-1/4 O.D.	1650 DP7 CHR	1650 007 CHR	8	1-5/8
<b>Fig. 1655</b>					
33-1/16	3-1/2 x 2	1655 DP4 CHR	1655 004 CHR	8	1-3/8
40-5/8	3-1/2 x 2	1655 DP5 CHR	1655 005 CHR	8	1-3/8
46-3/8	3-1/2 x 2	1655 DP6 CHR	1655 006 CHR	8	1-1/2
51-5/16	3-1/2 x 2	1655 DP7 CHR	1655 007 CHR	8	1-5/8

**SPARE PARTS FOR POLE LIGHTS ON THIS PAGE**

For Replacement Poles on this Page, See Page 35.  
For Spare Bases with Socket Assemblies on this Page, See Page 36

Spare Bulbs For Lights on this Page (2 per card), Cat. No. 338 DP2 CLR.  
Spare Lens Assembly, Cat. No. 239 DP BLK.

## WHITE ALL-ROUND POLE LIGHTS

CERTIFIED FOR USE ON POWER DRIVEN VESSELS UNDER 20 METERS (65.6 FT.) IN LENGTH.

NAVIGATION LIGHTS FOR VESSELS UNDER 20 METERS

### CONSTRUCTION:

- \* "REDUCED GLARE DESIGN"
- \* CLEAR FLUTED GLOBE WITH BLACK PLASTIC TOP
- \* 3/4 INCH DIAMETER ANODIZED TUBE WITH LOCKING COLLAR
- \* 12 VOLT BULB INCLUDED
- \* STOW-A-WAY PLUG-IN TYPE POLE
- \* WATER RESISTANT SLIDE COVER OR WATER PROOF COVER FOR BASES.



FIG. 1431



FIG. 1621

FIGS. 1450/1455

### FIG. 1431 - 5° ANGLED TOP

- \* BLACK PLASTIC AND CHROME PLATED ZINC ALLOY BASE

### FIG. 1621 - 5° ANGLED TOP

- \* BLACK PLASTIC AND CHROME PLATED BRASS BASE
- \* THREADED COLLAR ON POLE

### FIG. 1632 - STRAIGHT TOP

- \* BLACK PLASTIC AND CHROME PLATED BRASS BASE

### FIG. 1641 - 5° ANGLED TOP

- \* CHROME PLATED BRASS BASE WITH BLACK PLASTIC INSERT

### NEW ITEM

### FIG. 1450 - STRAIGHT TOP

- \* 54" FOLD IN HALF POLE

### FIG. 1455 - 5° ANGLED TOP

- \* 54" FOLD IN HALF POLE



FIG. 1641



FIG. 1632

NEW PRODUCT



### ORDERING INFORMATION

Vertical Height Inches	Base Dimensions Inches	Dealer Pkg. 5 Cards 1 Pc. per Card	OEM Bulk Pkg. 50 Pcs.	Screw Size	Weight Pounds
<b>Fig. 1431</b>					
33-3/16	3-3/4 x 1-3/4	1431 DP4 CHR	1431 004 CHR	8	1-1/4
40-11/16	3-3/4 x 1-3/4	1431 DP5 CHR	1431 005 CHR	8	1-3/8
46-1/4	3-3/4 x 1-3/4	1431 DP6 CHR	1431 006 CHR	8	1-1/2
51-7/16	3-3/4 x 1-3/4	1431 DP7 CHR	1431 007 CHR	8	1-5/8
<b>Fig. 1621</b>					
33-1/16	3-1/2 x 2	1621 DP4 CHR	1621 004 CHR	8	1-3/8
40-5/8	3-1/2 x 2	1621 DP5 CHR	1621 005 CHR	8	1-3/8
46-3/8	3-1/2 x 2	1621 DP6 CHR	1621 006 CHR	8	1-1/2
51-5/16	3-1/2 x 2	1621 DP7 CHR	1621 007 CHR	8	1-5/8
<b>Fig. 1632</b>					
33	2-1/4 O.D.	1632 DP4 CHR	1632 004 CHR	8	1-3/8
40-5/8	2-1/4 O.D.	1632 DP5 CHR	1632 005 CHR	8	1-3/8
46-3/8	2-1/4 O.D.	1632 DP6 CHR	1632 006 CHR	8	1-1/2
51-7/16	2-1/4 O.D.	1632 DP7 CHR	1632 007 CHR	8	1-5/8
<b>Fig. 1641</b>					
32-3/4	3-1/2 x 1-1/2	1641 DP4 CHR	1641 004 CHR	8	1-1/4
40-5/16	3-1/2 x 1-1/2	1641 DP5 CHR	1641 005 CHR	8	1-3/8
46-7/16	3-1/2 x 1-1/2	1641 DP6 CHR	1641 006 CHR	8	1-1/2
51-1/4	3-1/2 x 1-1/2	1641 DP7 CHR	1641 007 CHR	8	1-5/8
<b>Fig. 1450</b>					
54	-----	1450 DP7 CHR	1450 007 CHR	8	1-3/8
<b>Fig. 1455</b>					
54	-----	1455 DP7 CHR	1455 007 CHR	8	1-3/8

### SPARE PARTS FOR POLE LIGHTS ON THIS PAGE

For Replacement Poles on this Page Except Fig 1621, See Page 35.  
 For Spare Bases with Socket Assemblies on this Page, See Page 36.  
 Spare Lens Assembly, Cat. No. 238 DP BLK.  
 Spare Bulbs For Lights on this Page (2 per card), Cat. No. 338 DP2 CLR.

Fig 1621 Replacement Poles Size No. 4, Cat. No. 1621 DP4 99A.  
 Fig 1621 Replacement Poles Size No. 5, Cat. No. 1621 DP5 99A.  
 Fig 1621 Replacement Poles Size No. 6, Cat. No. 1621 DP6 99A.  
 Fig 1621 Replacement Poles Size No. 7, Cat. No. 1621 DP7 99A.

## WHITE ALL-ROUND POLE LIGHTS

CERTIFIED FOR USE ON SAIL OR POWER DRIVEN VESSELS UNDER 20 METERS (65.6 FT.) IN LENGTH.



### CONSTRUCTION:

- \* WHITE TRANSLUCENT GLOBE WITH BLACK PLASTIC TOP
- \* 3/4 INCH DIAMETER ANODIZED TUBE WITH LOCKING COLLAR
- \* WATER RESISTANT SLIDE COVER OR WATER PROOF COVER FOR BASES
- \* 12 VOLT BULB INCLUDED

### FIG. 1430 - STOW-A-WAY PLUG-IN TYPE

- \* CHROME PLATED ZINC ALLOY BASE WITH BLACK PLASTIC INSERT

### FIG. 1611- TELESCOPING TYPE

- \* CHROME PLATED ZINC ALLOY BASE

### FIG. 1630 - STOW-A-WAY PLUG-IN TYPE

- \* CHROME PLATED ZINC ALLOY BASE

### FIGS. 1631, 1640 & 1660 - STOW-A-WAY PLUG-IN TYPE

- \* BLACK PLASTIC AND CHROME PLATED BRASS BASE



### ORDERING INFORMATION

Vertical Height Inches	Base Dimensions Inches	Dealer Pkg. 5 Cards 1 Pc. per Card	OEM Bulk Pkg. 50 Pcs.	Screw Size	Weight Pounds
<b>Fig. 1430</b>					
22	3-3/4 x 1-3/4	1430 DP2 CHR	1430 002 CHR	8	1
27-5/8	3-3/4 x 1-3/4	1430 DP3 CHR	1430 003 CHR	8	1-1/8
33-5/8	3-3/4 x 1-3/4	1430 DP4 CHR	1430 004 CHR	8	1-1/4
41	3-3/4 x 1-3/4	1430 DP5 CHR	1430 005 CHR	8	1-3/8
46-7/8	3-3/4 x 1-3/4	1430 DP6 CHR	1430 006 CHR	8	1-1/2
51-7/8	3-3/4 x 1-3/4	1430 DP7 CHR	1430 007 CHR	8	1-5/8
<b>Fig. 1611</b>					
20-1/4	3-3/4 x 1-5/8	1611 DP2 CHR	1611 002 CHR	8	7/8
26-1/2	3-3/4 x 1-5/8	1611 DP3 CHR	1611 003 CHR	8	1
32-3/8	3-3/4 x 1-5/8	1611 DP4 CHR	1611 004 CHR	8	1-1/8
<b>Fig. 1630</b>					
21-5/8	3-3/4 x 1-5/8	1630 DP2 CHR	1630 002 CHR	8	1
27-1/4	3-3/4 x 1-5/8	1630 DP3 CHR	1630 003 CHR	8	1-1/8
33	3-3/4 x 1-5/8	1630 DP4 CHR	1630 004 CHR	8	1-1/4
40-1/8	3-3/4 x 1-5/8	1630 DP5 CHR	1630 005 CHR	8	1-3/8
45-7/8	3-3/4 x 1-5/8	1630 DP6 CHR	1630 006 CHR	8	1-1/2
50-3/4	3-3/4 x 1-5/8	1630 DP7 CHR	1630 007 CHR	8	1-5/8
<b>Fig. 1631</b>					
40-3/4	2-1/4 O.D.	1631 DP5 CHR	1631 005 CHR	8	1-3/8
46-7/8	2-1/4 O.D.	1631 DP6 CHR	1631 006 CHR	8	1-1/2
51-3/4	2-1/4 O.D.	1631 DP7 CHR	1631 007 CHR	8	1-5/8
<b>Fig. 1640</b>					
21-5/8	3-1/2 x 1-1/2	1640 DP2 CHR	1640 002 CHR	8	1
27-1/4	3-1/2 x 1-1/2	1640 DP3 CHR	1640 003 CHR	8	1-1/8
33-1/4	3-1/2 x 1-1/2	1640 DP4 CHR	1640 004 CHR	8	1-1/4
40-5/8	3-1/2 x 1-1/2	1640 DP5 CHR	1640 005 CHR	8	1-3/8
46-1/2	3-1/2 x 1-1/2	1640 DP6 CHR	1640 006 CHR	8	1-1/2
51-1/2	3-1/2 x 1-1/2	1640 DP7 CHR	1640 007 CHR	8	1-5/8
<b>Fig. 1660</b>					
40-5/8	3-1/2 x 1-1/2	1660 DP5 CHR	1660 005 CHR	8	1-3/8
46-7/8	3-1/2 x 1-1/2	1660 DP6 CHR	1660 006 CHR	8	1-1/2
51-3/4	3-1/2 x 1-1/2	1660 DP7 CHR	1660 007 CHR	8	1-5/8

### SPARE PARTS FOR POLE LIGHTS ON THIS PAGE

For Replacement Poles on this Page, See Page 35.

For Spare Bases with Socket Assemblies on this Page, See Page 36

Spare Bulbs For Lights on this Page (2 per card), Cat. No. 337 012 DP.

Spare Globe, Cat. No. 201 DP WHT.

## WHITE ALL-ROUND POLE LIGHTS

NAVIGATION LIGHTS FOR VESSELS UNDER 20 METERS

**FIGS. 1209, 1311 & 1330 - CERTIFIED FOR USE ON POWER DRIVEN VESSELS UNDER 20 METERS (65.6 FT.) IN LENGTH.**



**CONSTRUCTION:**

- \* CLEAR FRESNEL GLOBE
- \* 3/4 INCH DIAMETER ANODIZED TUBE WITH LOCKING COLLAR
- \* WATER PROOF COVER FOR BASE
- \* 12 VOLT BULB INCLUDED

**FIG. 1209 - STOW-A-WAY PLUG-IN TYPE**

- \* CHROME PLATED BRASS TOP AND BASE
- \* WATERPROOF CAP AND RETAINER



**FIG. 1209**

16° RAKE

**FIG. 1311 - TELESCOPING TYPE**

- \* BLACK PLASTIC TOP, CHROME PLATED ZINC ALLOY BASE



**FIG. 1311**

16° RAKE

**FIG. 1330 - STOW-A-WAY PLUG-IN TYPE**

- \* BLACK PLASTIC TOP, CHROME PLATED ZINC ALLOY BASE



**FIG. 1330**

16° RAKE



**ORDERING INFORMATION**

Vertical Height Inches	Base Dimensions Inches	Dealer Pkg. 5 Cards 1 Pc. per Card	OEM Bulk Pkg. 50 Pcs.	Screw Size	Weight Pounds
<b>Fig. 1209</b>					
21-7/8	3-3/8 x 2-1/4	1209 DP2 CHR	1209 002 CHR	8	1
28-1/2	3-3/8 x 2-1/4	1209 DP3 CHR	1209 003 CHR	8	1-1/4
34-1/8	3-3/8 x 2-1/4	1209 DP4 CHR	1209 004 CHR	8	1-1/2
<b>Fig. 1311</b>					
20-1/8	3-3/4 x 1-5/8	1311 DP2 CHR	1311 002 CHR	8	7/8
26-5/8	3-3/4 x 1-5/8	1311 DP3 CHR	1311 003 CHR	8	1
32-3/8	3-3/4 x 1-5/8	1311 DP4 CHR	1311 004 CHR	8	1-1/8
<b>Fig. 1330</b>					
20-11-1/6	3-3/4 x 1-5/8	1330 DP2 CHR	1330 002 CHR	8	1
27-1/4	3-3/4 x 1-5/8	1330 DP3 CHR	1330 003 CHR	8	1-1/8
33	3-3/4 x 1-5/8	1330 DP4 CHR	1330 004 CHR	8	1-1/4

Fig. 1209: Spare Bulb Socket, Cat. No. 24 DP2.  
 Fig. 1209: Spare Cap for Base, Cat. No. 125 DP BLK.  
 Fig. 1209: Replacement Pole Size No. 2, Cat. No. 1209 DP2 99A.  
 Fig. 1209: Replacement Pole Size No. 3, Cat. No. 1209 DP3 99A.  
 Fig. 1209: Replacement Pole Size No. 4, Cat. No. 1209 DP4 99A.  
 Fig. 1330: Replacement Pole Light Size No. 2, Cat. No. 1330 DP2 99A  
 Fig. 1330: Replacement Pole Light Size No. 3, Cat. No. 1330 DP3 99A  
 Fig. 1330: Replacement Pole Light Size No. 4, Cat. No. 1330 DP4 99A

Spare Bulbs (2 per card), Cat. No. 337 011 DP.  
 Spare Globe, Cat. No. 248 DP CLR.  
 Spare Bases & Socket Assemblies See Page 36.

## WHITE ALL-ROUND POLE LIGHTS



**IMPROVED  
ADJUSTABILITY**



**Fig. 1134**     **Fig. 1137**



**FIGS. 1134/1137 - CERTIFIED FOR USE ON SAIL OR POWER DRIVEN VESSELS UNDER 20 METERS (65.6 FT.) IN LENGTH.**

**CONSTRUCTION:**

- \* **WHITE TRANSLUCENT GLOBE**
- \* **BLACK PLASTIC BASE**
- \* **3/4 INCH DIAMETER ANODIZED ALUMINUM TUBE**
- \* **PLASTIC ADAPTERS FOR FLAT OR "V" TYPE MOUNT)**
- CONTAINS NOTCH FOR THROUGH-BASE WIRING**
- \* **FOLD-DOWN, ADJUSTABLE ANGLE**
- \* **12 VOLT BULB INCLUDED**

**Fig. 1134 - HORIZONTAL MOUNT**

**Fig. 1137 - VERTICAL MOUNT**



**ORDERING INFORMATION**

Vertical Height Inches	Dimensions Base Inches	Dealer Pkg. - 5 Cards 1 Pc. per Card	OEM Bulk Pkg. 50 Pcs.	Screw Size	Weight Ounces
14	2 x 1-1/2	1134 DP CHR	1134 000 CHR	8	13
14	2-1/4 x 5/8	1137 DP CHR	1137 000 CHR	8	13

Spare Bulb (2 per card), Cat. No. 337 012 DP.  
Spare Globe, Cat. No. 201 DP WHT.  
Old Style Zinc Spare Bracket with Knob and End Plug for Fig. No. 1134, Cat. No. 1052 DP CHR.  
Old Style Zinc Spare Bracket with Knob and End Plug for Fig. No. 1137, Cat. No. 1054 DP CHR.  
New Style Plastic Spare Bracket with Knob and End Plug for Fig. No. 1134, Cat. No. 1052 DPB BLK.  
New Style Plastic Spare Bracket with Knob and End Plug for Fig. No. 1137, Cat. No. 1054 DPB BLK.

**FIGS. 1634/1637 - CERTIFIED FOR USE ON POWER DRIVEN VESSELS UNDER 12 METERS (39.4 FT.) IN LENGTH.**



**IMPROVED  
ADJUSTABILITY**



**Fig. 1634**     **Fig. 1637**



**CONSTRUCTION:**

**THE NEXT GENERATION**

**"NEW REDUCED GLARE DESIGN".**

- \* **BLACK PLASTIC TOP WITH CLEAR FLUTED LENS & FROSTED GLOBE**
- \* **BLACK PLASTIC BASE**
- \* **3/4 INCH DIAMETER ANODIZED ALUMINUM TUBE**
- \* **PLASTIC ADAPTERS FOR FLAT OR "V" TYPE MOUNT,**
- CONTAINS NOTCH FOR THROUGH-BASE WIRING**
- \* **12 VOLT BULBS INCLUDED**

**Fig. 1634 - HORIZONTAL MOUNT**

**Fig. 1637 - VERTICAL MOUNT**



**ORDERING INFORMATION**

Vertical Height Inches	Dimensions Base Inches	Dealer Pkg. - 5 Cards 1 Pc. per Card	OEM Bulk Pkg. 50 Pcs.	Screw Size	Weight Ounces
13-3/8	2 x 1-1/2	1634 DP CHR	1634 000 CHR	8	13
13-3/8	2-1/4 x 5/8	1637 DP CHR	1637 000 CHR	8	13

Spare Bulb (2 per card), Cat. No. 338 DP2 CLR.  
Spare Lens Assembly, Cat. No. 239 DP BLK.  
Old Style Zinc Spare Bracket with Knob and End Plug for Fig. No. 1634, Cat. No. 1052 DP CHR.  
Old Style Zinc Spare Bracket with Knob and End Plug for Fig. No. 1637, Cat. No. 1054 DP CHR.  
New Style Plastic Spare Bracket with Knob and End Plug for Fig. No. 1634, Cat. No. 1052 DPB BLK.  
New Style Plastic Spare Bracket with Knob and End Plug for Fig. No. 1637, Cat. No. 1054 DPB BLK.



## WHITE ALL-ROUND LIGHTS

**FIGS. 120/170 SWB & 1301 - CERTIFIED FOR USE ON SAIL OR POWER DRIVEN VESSELS UNDER 20 METERS (65.6 FT.) IN LENGTH.**

**FIG. 1604 - CERTIFIED FOR USE ON POWER DRIVEN VESSELS UNDER 20 METERS (65.6 FT.) IN LENGTH.**



NAVIGATION LIGHTS FOR VESSELS UNDER 20 METERS

### CONSTRUCTION:

- \* FIXED MOUNT BLACK PLASTIC BASE
- \* 3/4 INCH DIAMETER ANODIZED ALUMINUM TUBE
- 12 OR 24 VOLT BULBS INCLUDED

**FIGS. 120/170 SWB & 1301 - WHITE TRANSLUCENT GLOBE**

- \* BLACK PLASTIC TOP

**FIG. 1604 - THE NEXT GENERATION "NEW REDUCED GLARE" DESIGN.**

- \* BLACK PLASTIC TOP WITH CLEAR FLUTED LENS & FROSTED GLOBE



**FIGS. 120 SWB & 170 SWB**

**FIG. 1301**

**NEW PRODUCT**



**FIG. 1604**



### ORDERING INFORMATION

Vertical Height Inches	Dimensions Base Inches	Dealer Pkg. - 5 Cards 1 Pc. per Card	OEM Bulk Pkg. 50 Pcs.	Screw Size	Weight Ounces
3-7/8	1 x 2-5/8	120 SWB DP1	120 SWB 12V	8	7
3-7/8	1 x 2-5/8	170 SWB DP2	170 SWB 24V	8	7
7-1/8	1 x 2-5/8	1301 DP CHR	1301 000 CHR	8	8
6-3/4	1 x 2-5/8	1604 DP CHR	1604 000 CHR	8	8

Spare Bulb For Fig. 1604 (2 per card), Cat. No. 338 DP2 CLR.  
Spare Lens Assembly For Fig. 1604, Cat. No. 239 DP BLK.  
Spare 12 Volt Bulbs For Fig. 120 SWB (2 per card), Cat. No. 337 012 DP.  
For Fig. 120/170 SWB Spare Globe, Cat. No. 201 DP WHT.  
Spare 24 Volt Bulb For Fig. 170 SWB, (1 per card), Cat. No. 337 014 DP.

## POLE STORAGE CLIPS & GLARE SHIELD

**FIG. 477 - POLE STORAGE CLIPS**

### CONSTRUCTION

- \* SOFT BLACK PLASTIC. U.V. STABILIZED
- \* FITS 3/4 INCH DIAMETER TUBING



### ORDERING INFORMATION

For Pole O.D. Inches	Dimensions Inches	Dealer Pkg. 10 Cards 1 Pair per Card	OEM Bulk Pkg. 50 Pair	Screw Size	Weight per Pair Ounces
3/4	3/4 x 2-1/4 x 1-5/8	477 DP BLK	477 000 BLK	10 P.H.	3



**FIG. 477**



**GLARE SHIELD - FIG. 1192**

### CONSTRUCTION:

- \* BLACK PLASTIC
- \* FOR 3/4 INCH O.D. TUBING
- \* CAN BE INSTALLED WITHOUT REMOVING LIGHT



### ORDERING INFORMATION

Dimensions Inches	Dealer Pkg. - 5 Cards 1 Pc. per Card	OEM Bulk Pkg. 25 Pcs.	Weight Ounces
6 x 4-5/16	1192 DP BLK	1192 000 BLK	3

**FIG. 1192**



## NAVIGATION LIGHT VERTICAL HEIGHTS

NOTE: Vertical Height "H" is Measured from the Center of the Bulb Filament to the Mounting Surface and May be Used as a Generalized Guide for the Selection of Lights in Accordance with the '72 COLREGS and the 1 Meter Vertical Light Separation Requirements of Navigation Regulations.

### BI-COLOR LIGHTS

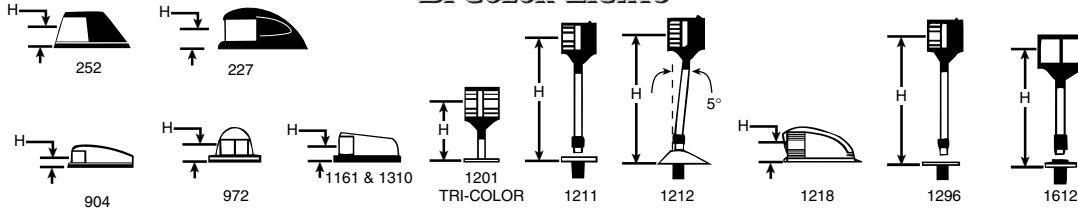

#### Bi-Color LIGHTS

FIG.	227	252	904	972	1161	1201	1211	1212	1218	1296	1310	1612
H	5/8	13/16	7/8	7/8	1	3-1/4	10	10-7/16	1-5/8	10	1	9-3/4

### WHITE ALL-ROUND LIGHTS

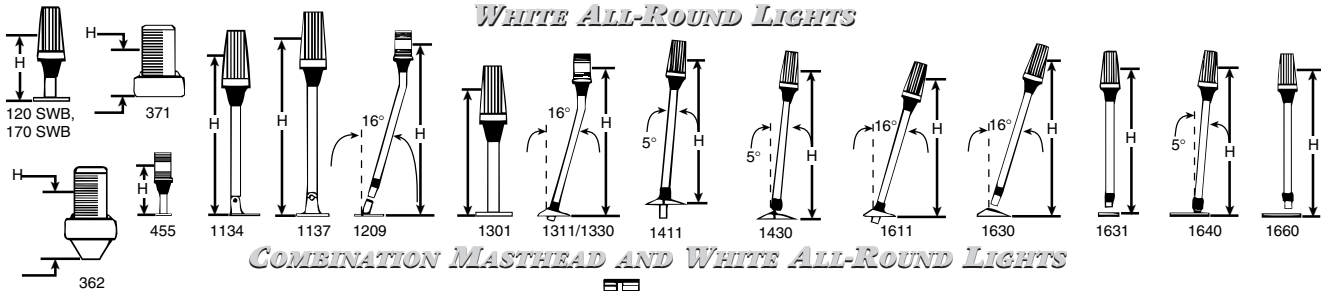

### COMBINATION MASTHEAD AND WHITE ALL-ROUND LIGHTS

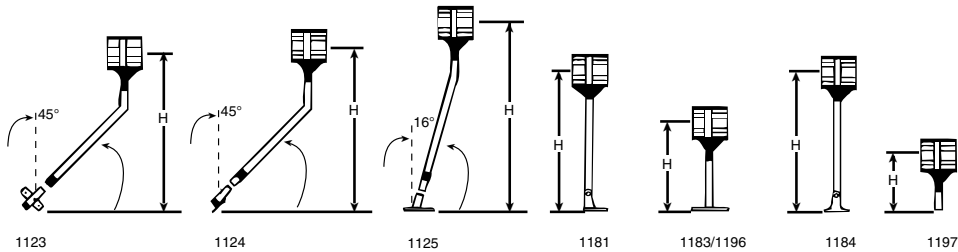

#### DIMENSIONS

SIZE		1	2	3	4	5	6	7
FIG.	H	H	H	H	H	H	H	H
<b>WHITE ALL-ROUND LIGHTS</b>								
120 SWB	3-7/8							
170 SWB	3-7/8							
362	1-1/2							
371	1-1/2							
455		4-1/2	11-7/8					
1134	14							
1137	14							
1209			21-7/8	28-1/2	34-1/8			
1301	7-1/8							
1311			20-1/8	26-5/8	32-3/8			
1330			20-11/16	27-1/4	33			
1411			22	27-5/8	33-5/8			
1430			22	27-5/8	33-5/8	41	46-7/8	51-7/8
1611			20-1/4	26-1/2	32-3/8			
1630			21-5/8	27-1/4	33	40-1/8	45-7/8	50-3/4
1631						40-3/4	46-7/8	51-3/4
1640			21-5/8	27-1/4	33-1/4	40-5/8	46-1/2	51-1/2
1660						40-5/8	46-7/8	51-3/4
<b>COMBINATION MASTHEAD AND WHITE ALL-ROUND LIGHTS</b>								
1123			11-1/4	20-1/2				
1124			12-1/2	22				
1125					33-7/8			
1181	12-13/16							
1183	3-3/16							
1184	12-13/16							
1196		5-1/16	11-1/4					
1197	4							

### SIDE LIGHTS

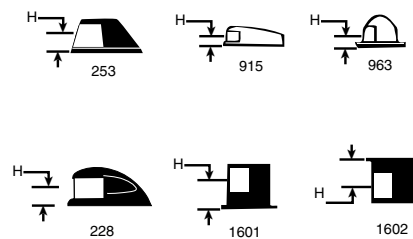

#### SIDE LIGHTS

FIG.	228	253	915	963	1601	1602
H	5/8	13/16	7/8	7/8	1-1/4	1-1/4

### MASTHEAD LIGHTS

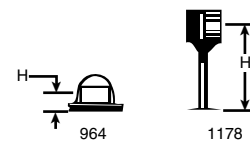

#### MASTHEAD LIGHTS

FIG.	964	1178
H	7/8	3-1/4

## NAVIGATION LIGHT VERTICAL HEIGHTS

NOTE: Vertical Height "H" is Measured from the Center of the Bulb Filament to the Mounting Surface and May be Used as a Generalized Guide for the Selection of Lights in Accordance with the '72 COLREGS and the 1 Meter Vertical Light Separation Requirements of Navigation Regulations.

NAVIGATION LIGHTS FOR VESSELS UNDER 20 METERS

### "REDUCED GLARE" DESIGN BI-COLOR LIGHTS

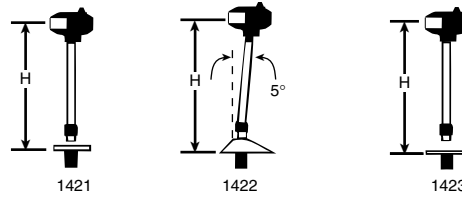

<b>"REDUCED GLARE" DESIGN BI-COLOR LIGHTS</b>			
FIG.	1421	1422	1423
H	9-9/16	9-7/8	9-9/16

### "REDUCED GLARE" DESIGN WHITE ALL-ROUND LIGHTS

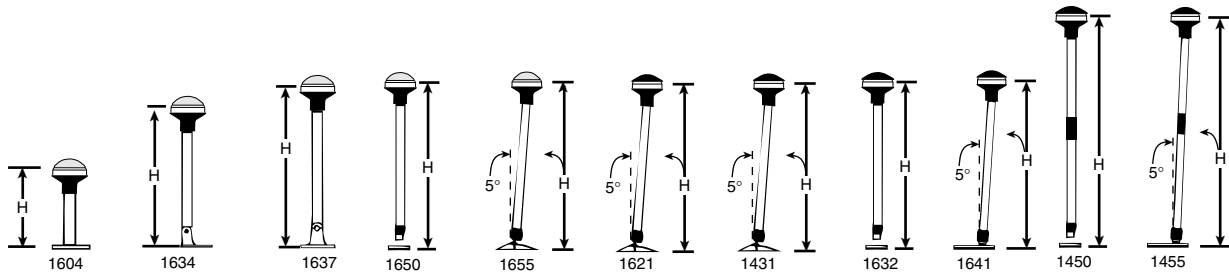

### "REDUCED GLARE" DESIGN COMBINATION MASTHEAD AND WHITE ALL-ROUND LIGHTS

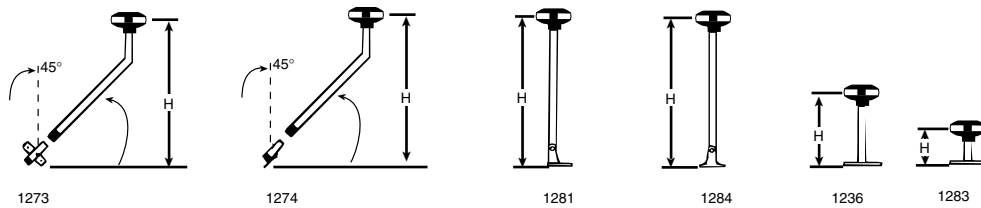

<b>DIMENSIONS</b>								
SIZE	1	2	3	4	5	6	7	
FIG.	H	H	H	H	H	H	H	H
<b>"REDUCED GLARE" DESIGN WHITE ALL-ROUND LIGHTS</b>								
1431				33-3/16	40-11/16	46-1/4	51-7/16	
1450							51-7/16	
1455							51-5/16	
1604	6-3/4							
1621				33-1/16	40-5/8	46-3/8	51-5/16	
1634	13-3/8							
1632				33	40-5/8	46-3/8	51-7/16	
1637	13-1/2							
1641				32-3/4	40-5/16	46-7/16	51-1/4	
1650				33	40-5/8	46-3/8	51-5/16	
1655				33-1/16	40-5/8	46-3/8	51-5/16	
<b>"REDUCED GLARE" DESIGN COMBINATION MASTHEAD AND WHITE ALL-ROUND LIGHTS</b>								
1236		4-1/2	11					
1273			10-5/8	20				
1274			11-7/8	21-5/8				
1281	12-3/16							
1283	2-1/4							
1284	12-3/16							

## EUROPEAN STYLE NAVIGATION LIGHTS

**120 SERIES - CERTIFIED FOR USE ON SAIL OR POWER DRIVEN VESSELS UNDER 12 METERS (39.4 FT.) IN LENGTH. (12 VOLT ONLY)**

**FIG. 170 - CERTIFIED FOR USE ON SAIL OR POWER DRIVEN VESSELS UNDER 20 METERS (65.6 FT.) IN LENGTH. (12 OR 24 VOLT)**



**CONSTRUCTION OPTIONS:**

- \* **CHROME PLATED BRASS TOP WITH BLACK PLASTIC BASE**
- \* **ALL BLACK PLASTIC**
- \* **ALL WHITE PLASTIC**
- \* **12 VOLT OR 24 VOLT BULB INCLUDED**

Fig.	Height Overall Inches	Projection Overall Inches	Width Inches	Screw Size	Weight Ounces
120/170 Series	3-5/8	2-1/2	4-1/8	10	5
120 & 170 BMD	7	4-3/4	4-1/8	10	18-1/2
120 SWB	5-1/8*	-----	2-1/2	8	4-1/2
170 SWB	5-1/8*	-----	2-1/2	8	4-1/2

\*Vertical Height - 3-3/4 Inches.

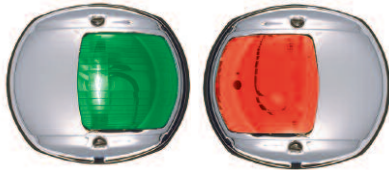

**Fig. 120 MSD**    **Fig. 120 MP**  
**170 MSD**        **170 MP**

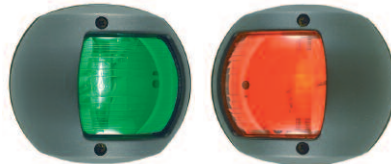

**Fig. 120 BSD**    **Fig. 120 BP**  
**170 BSD**        **170 BP**

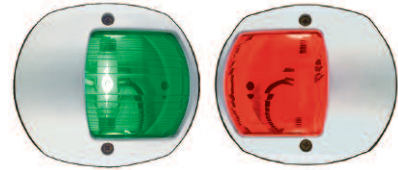

**Fig. 120 WSD**    **Fig. 120 WP**  
**170 WSD**        **170 WP**



**Fig. 120 MB**  
**170 MB**



**Fig. 120 BB**  
**170 BB**

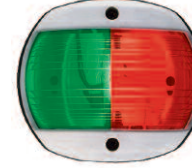

**Fig. 120 WB**  
**170 WB**



**Fig. 120 MSN**    **Fig. 120 MM**  
**170 MSN**        **170 MM**

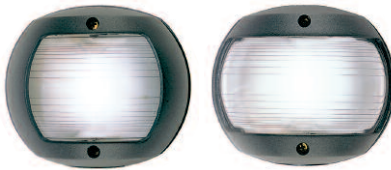

**Fig. 120 BSN**    **Fig. 120 BM**  
**170 BSN**        **170 BM**



**Fig. 120 WSN**    **Fig. 120 WM**  
**170 WSN**        **170 WM**



**Fig. 120 SWB &**  
**170 SWB**



**Fig. 120 BMD &**  
**170 BMD**

**170 BMD**  
**12 VOLT ONLY**

**SPARE PARTS ORDERING INFORMATION**

Spare Halogen Bulb for Deck Spreader Light, Cat. No. 68 12V 20W.  
Spare Bulbs (2 per card) for 120 SWB, Cat. No. 337 012 DP.  
Spare Bulb for 170 SWB, (1 per card) (24 Volt), Cat. No. 337 014 DP.  
Spare Bulbs (2 per card) for All Other 120's, Cat. No. 69 DP CLR.

Spare Bulbs (2 per card) for 170 BSN, MSN & WSN (24 Volt), Cat. No. 67 DP1 CLR.  
Spare Bulbs (2 per card) for 170 BSN, MSN & WSN (12 Volt), Cat. No. 69 DP CLR.  
Spare Bulbs (2 per card) for All Other 12 Volt 170's, Cat. No. 70 DP1 CLR.  
Spare Bulbs (2 per card) for All Other 24 Volt 170's, Cat. No. 67 DP2 CLR.

For Spare Lens and Shield Assembly, Replace the Last Three Digits of the Catalog Number with the Letters "LNS" (e.g., 120 BB LNS, for a Black Shield and Bi-Color Lens).

## EUROPEAN STYLE NAVIGATION LIGHTS

### 120 SERIES & 170 SERIES LIGHTS



#### ORDERING INFORMATION - 120 SERIES 12 VOLT

Description	Visibility Arc	Dealer Pkg. - 5 Cards 1 Pc. per Card	OEM Bulk Pkg. 10 Pcs.	Visibility Miles
<b>Black Plastic</b>				
Bi-Color Light	225°	120 BB DP1	-----	1
Red Side Light	112-1/2°	120 BP DP1	120 BP 12V	1
Green Side Light	112-1/2°	120 BSD DP1	120 BSD 12V	1
White Masthead Light	225°	120 BM DP1	-----	2
White Stern Light	135°	120 BSN DP1	-----	2
<b>Chrome Plated Brass</b>				
Bi-Color Light	225°	120 MB DP1	-----	1
Red Side Light	112-1/2°	120 MP DP1	-----	1
Green Side Light	112-1/2°	120 MSD DP1	-----	1
White Masthead Light	225°	120 MM DP1	-----	2
White Stern Light	135°	120 MSN DP1	-----	2
<b>White Plastic</b>				
Bi-Color Light	225°	120 WB DP1	-----	1
Red Side Light	112-1/2°	120 WP DP1	120 WP 12V	1
Green Side Light	112-1/2°	120 WSD DP1	120 WSD 12V	1
White Masthead Light	225°	120 WM DP1	-----	2
White Stern Light	135°	120 WSN DP1	-----	2
<b>Masthead/Deck Spreader Light</b>	225°	120 BMD DP1	-----	2
<b>White All-Round Light</b>	360°	120 SWB DP1	120 SWB 12V**	2



#### ORDERING INFORMATION - 170 SERIES 12 & 24 VOLT

Description	Visibility Arc	12 Volt		24 Volt		Visibility Miles
		Dealer Pkg. - 5 Cards 1 Pc. per Card	OEM Bulk Pkg. 10 Pcs	Dealer Pkg. - 5 Cards 1 Pc. per Card	OEM Bulk Pkg. 10 Pcs	
<b>Black Plastic</b>						
Bi-Color Light	225°	170 BB DP1	-----	170 BB DP2	-----	2
Red Side Light	112-1/2°	170 BP DP1	-----	170 BP DP2	-----	2
Green Side Light	112-1/2°	170 BSD DP1	-----	170 BSD DP2	-----	2
White Masthead Light	225°	170 BM DP1	-----	170 BM DP2	-----	3
White Stern Light	135°	170 BSN DP1	-----	170 BSN DP2	-----	2
<b>Chrome Plated Brass</b>						
Bi-Color Light	225°	170 MB DP1	-----	170 MB DP2	-----	2
Red Side Light	112-1/2°	170 MP DP1	170 MP 12V	170 MP DP2	-----	2
Green Side Light	112-1/2°	170 MSD DP1	170 MSD 12V	170 MSD DP2	-----	2
White Masthead Light	225°	170 MM DP1	170 MM 12V	170 MM DP2	-----	3
White Stern Light	135°	170 MSN DP1	170 MSN 12V	170 MSN DP2	-----	2
<b>White Plastic</b>						
Bi-Color Light	225°	170 WB DP1	170 WB 12V	170 WB DP2	-----	2
Red Side Light	112-1/2°	170 WP DP1	170 WP 12V	170 WP DP2	170 WP 24V	2
Green Side Light	112-1/2°	170 WSD DP1	170 WSD 12V	170 WSD DP2	170 WSD 24V	2
White Masthead Light	225°	170 WM DP1	170 WM 12V	170 WM DP2	-----	3
White Stern Light	135°	170 WSN DP1	170 WSN 12V	170 WSN DP2	-----	2
<b>White All-Round Light</b>	360°	(See 120 SWB Above)	(See 120 SWB Above)	170 SWB DP2	-----	2
<b>Mast/Dk Spreader Lt</b>	225°	170 BMD DP1	-----	-----	-----	3

\*\*OEM Bulk Pkg. - 50 pcs.

## EUROPEAN STYLE NAVIGATION LIGHTS

**200 SERIES - CERTIFIED FOR USE ON SAIL OR POWER DRIVEN VESSELS  
UNDER 20 METERS (65.6 FT.) IN LENGTH.**



**CONSTRUCTION OPTIONS:**

\* **12, 24 OR 32 VOLT BULB INCLUDED**

**TOP MOUNT**

\* **BLACK PLASTIC WITH STAINLESS STEEL MOUNTING BRACKET**

**BASE MOUNT**

\* **BLACK PLASTIC**

**HALYARD MOUNT**

\* **BLACK PLASTIC WITH STAINLESS STEEL MOUNTING HARDWARE**

	Height Overall Inches	Projection Inches	O.D. Base Inches	Height Lens Inches	Screw Size	Weight Ounces
Top Mount	4-13/16	3-5/16	-----	2-3/4	8	12-1/2
Base Mount	4-7/8	-----	3-5/16	2-3/4	10	9-1/2
Halyard	7-1/8	-----	3-5/16	2-3/4	----	9
Base Mount	8-5/8	-----	3-5/16	2-3/4	10	14

**FIG. 200 SERIES TOP MOUNT**



**FIG. 200 SDT      FIG. 200 PT**



**FIG. 200 BT**



**FIG. 200 SNT      FIG. 200 TWT**

**FIG. 200 SERIES DOUBLE STACK  
BASE MOUNT**



**FIG. 200 GRB**

**FIG. 200 SERIES  
HALYARD MOUNT**



**FIG. 200 SRH**

**FIG. 200 SERIES BASE MOUNT**



**FIG. 200 SGB      FIG. 200 SRB**



**FIG. 200 BB**



**FIG. 200 SNB      FIG. 200 TWB**

**SPARE PARTS ORDERING INFORMATION**

Spare Lens Assembly Part Numbers are Determined by Replacing the Last Three Digits of the Catalog Number with the Letters "LNS" (example: 200 BT LNS, for a Bi-Color Top Mount Lens Assembly).

Spare Replacement Bulb Sockets: (single and lower for double) Cat. No. 93, (upper for double), Cat No. 95.

## EUROPEAN STYLE NAVIGATION LIGHTS

200 SERIES TOP MOUNT, BASE MOUNT,  
HALYARD MOUNT & DOUBLE STACK BASE MOUNT.



NAVIGATION LIGHTS FOR  
VESSELS UNDER 20 METERS

### ORDERING INFORMATION - FOR 12 VOLT LIGHTS

Description	Visibility Arc	Dealer Pkg. - 5 Cards 1 Pc. per Card	Visibility Miles	Replacement Bulb
<b><u>TOP MOUNT</u></b>				
Bi-Color Light	225°	200 BT DP1	2	375 12V 25W
Red Side Light	112-1/2°	200 PT DP1	2	375 12V 25W
Green Side Light	112-1/2°	200 SDT DP1	2	375 12V 25W
White Masthead Light	225°	200 MT DP1	3	375 12V 25W
White Stern Light	135°	200 SNT DP1	2	375 12V 10W
Yellow Towing Light	135°	200 TWT DP1	2	375 12V 10W
<b><u>BASE MOUNT</u></b>				
Bi-Color Light	225°	200 BB DP1	2	375 12V 25W
Red Side Light	112-1/2°	200 PB DP1	2	375 12V 25W
Green Side Light	112-1/2°	200 SDB DP1	2	375 12V 25W
White Masthead Light	225°	200 MB DP1	3	375 12V 25W
White Stern Light	135°	200 SNB DP1	2	375 12V 10W
Yellow Towing Light	135°	200 TWB DP1	2	375 12V 10W
White All-Round Light	360°	200 SWB DP1	2	375 12V 10W
Red All-Round Light	360°	200 SRB DP1	2	375 12V 25W
Green All-Round Light	360°	200 SGB DP1	2	375 12V 25W
Tri-Color Light*	360°	200 TB DP1	2	375 12V 25W
<b><u>HALYARD MOUNT</u></b>				
White All-Round Light	----	200 SWH DP1	2	375 12V 10W
Red All-Round Light	----	200 SRH DP1	2	375 12V 25W
Green All-Round Light	----	200 SGH DP1	2	375 12V 25W
<b><u>DOUBLE STACK BASE MOUNT</u></b>				
Tri-Color/White All-Round Light*	----	200 TAB DP1	2/2	375 12V 25W/10W
Masthead/White All-Round Light	----	200 MAB DP1	3/2	375 12V 25W/10W
Green/Red All-Round Light	----	200 GRB DP1	2/2	375 12V 25W/25W

\* For Use on Vessels Under Sail Alone.

### ORDERING INFORMATION - FOR 24V LIGHTS

Replace the "DP1" with "DP2".  
For the Replacement Bulb,  
Replace the "12V" with "24V" (e.g., 375 24V 25W).

### ORDERING INFORMATION - FOR 32V LIGHTS

Replace the "DP1" with "DP3".  
For the Replacement Bulb,  
Replace the "12V" with "32V" (e.g., 375 32V 25W).

**FIG. 222 - PIPE MOUNTING BRACKET - FOR USE ON ALL 200 SERIES BASE MOUNT LIGHTS.**

#### CONSTRUCTION:

\* **BLACK PLASTIC**

\* **INCLUDES SCREWS AND SOFT BLACK MOUNTING GASKET FOR MOUNTING BRACKET TO LIGHT**



#### ORDERING INFORMATION

O.D. Overall Inches	Tapped Pipe Size Inches	Dealer Pkg. - 5 bags 1 Pc. per bag
3-5/16	1/2	222 DP BLK



**FIG. 222**



## NAVIGATION LIGHTS

**CERTIFIED FOR USE ON SAIL OR POWER DRIVEN VESSELS  
UNDER 20 METERS (65.6 FT.) IN LENGTH.**

**CONSTRUCTION:**

- \* **BLACK PLASTIC**
- \* **FOR 12, 24 OR 32 VOLTS, BULB NOT INCLUDED**



Fig.	Height Overall Inches	Height Lens Inches	Tapped Pipe Size	Screw Size	Weight Pounds
108	6	5	1/2*	10	1-3/4
All Others	5-1/4	4-1/4	----	10	2

**ORDERING INFORMATION**

Description	Visibility Arc	Black Plastic Std Pkg. - 1 Pc.	Visibility Miles
Red Side Light	112-1/2°	109 R00 BLK	2
Green Side Light	112-1/2°	109 G00 BLK	2
White Masthead Light	225°	110 000 BLK	3
White Stern Light	135°	111 000 BLK	2
Yellow Towing Light	135°	111 M00 BLK	2
White All-Round Light**	360°	108 000 BLK	2
Red All-Round Light	360°	108 R00 BLK	2
Green All-Round Light	360°	108 G00 BLK	2

\*Base Removable for Flush Mounting.  
\*\*This Light is Supplied with a Gray Tinted Globe.



**FIG. 109**



**FIG. 110**



**FIG. 108**



**FIG. 111**



**FIG. 109**

**SPARE PARTS ORDERING INFORMATION**

**Spare Lenses:**  
112-1/2° Fig. No. 259 H02, Specify Color.  
135° Fig. No. 269 H02, Specify Color.  
225° Cat. No. 256 H02 WHT.  
360° Fig. No. 106 000, Specify Color.

**Required Bulbs:**  
For 12 Volts (2 per card), Cat. No. 70 DP1 CLR.  
For 24 Volts (2 per card), Cat. No. 67 DP2 CLR.  
For 32 Volts (2 per card), Cat. No. 70 DP2 CLR.  
Spare Base and Gasket for Fig. No. 108, Cat. No. 222 DP BLK.

**FIG. 329 - MEAL AND ABSENT LIGHT**

**CONSTRUCTION:**

- \* **CHROME PLATED BRONZE WITH BLUE & WHITE PLASTIC LENSES**
- \* **FOR 12 OR 32 VOLT, BULBS NOT INCLUDED**
- \* **DOUBLE CONTACT BAYONET SOCKETS**
- \* **BLUE OWNER ABSENT LIGHT AND WHITE MEALTIME LIGHT**
- \* **REPLACES BLUE AND WHITE FLAGS FOR USE AT NIGHT**
- \* **FOR MOUNTING ON MAIN STARBOARD YARDARM**

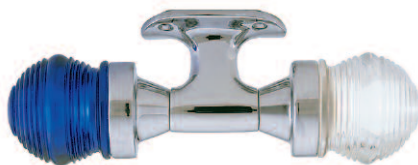

**FIG. 329**

**ORDERING INFORMATION**

Dimensions Base Inches	Length Overall Inches	O.D. Globe Inches	Standard Pkg. - 1 pc.	Screw Size	Weight Pounds
3-3/8 x 1-3/4	9	2-1/2	329 000 CHR	8	2

**SPARE PARTS ORDERING INFORMATION**

Required Bulbs (2 per card) For 12 Volt Use, Cat. No. 337 011 DP.  
Required Bulbs (1 per card) For 32 Volt Use, Cat. No. 337 018 DP.  
Spare Socket, Cat. No. 24 DP1.  
Spare Blue Globe, Cat. No. 250 000 BLU.  
Spare White Globe, Cat. No. 250 000 WHT.



## NAVIGATION LIGHTS

**CERTIFIED FOR USE ON POWER DRIVEN VESSELS UNDER 20 METERS (65.6 Ft.) IN LENGTH.**

### CONSTRUCTION:

- \* GALVANIZED STEEL SHEET METAL OR POLISHED BRASS
- \* BOTTOM OPENING, COMPLETE WITH MOUNTING BRACKET
- \* FOR 12 OR 32 VOLTS, BULB NOT INCLUDED



Height Overall Inches	Height Lens Inches	Screw Size	Weight Pounds
8-1/2	5-1/8	10	3-1/2

### ORDERING INFORMATION

Description	Visibility Arc	Galvanized Steel	Polished Brass	Visibility Miles
Side Lights (Pair)	112-1/2°	4 F03 GAL	4 F03 POL	2
Red Side Light	112-1/2°	4 RF3 GAL	4 RF3 POL	2
Green Side Light	112-1/2°	4 GF3 GAL	4 GF3 POL	2
White Masthead Light	225°	5 F03 GAL	5 F03 POL	3
White Stern Light	135°	7 F03 GAL	7 F03 POL	2
Yellow Towing Light	135°	7 MF3 GAL	7 MF3 POL	2



**FIG. 7F**



**FIG. 7MF**



**FIG. 5F**



**FIG. 4F**

### SPARE PARTS ORDERING INFORMATION

#### Spare Lenses:

112-1/2° Fig. No. 259 CL3, Specify Color.

135° Fig. No. 269 CL3, Specify Color.

225° Cat. No. 256 CL3 WHT.

Spare Mounting Bracket, Cat. No. 131 000 GAL or PLB.

Spare Electric Adapter, Cat. No. 290 F03.

#### Required Bulbs:

Bulbs (12 volts-2 per card), Cat. No. 70 DP1 CLR.

Bulbs (32 volts-2 per card), Cat. No. 70 DP2 CLR.

## ALL-ROUND LIGHTS

**FIG. 108 - CERTIFIED FOR USE ON POWER DRIVEN VESSELS UNDER 20 METERS (65.6 FT.) IN LENGTH.**



**Fig. 108**

**CONSTRUCTION:**

- \* BLACK PLASTIC WITH FESTOON TYPE ELECTRICAL SOCKET
- \* FOR 12, 24 OR 32 VOLTS, BULB NOT INCLUDED



**ORDERING INFORMATION**

Description	Height Overall Inches	O.D. Base Inches	Tapped Pipe Size Inches	Black Plastic Standard Pkg. - 1 Pc.	Screw Size	Weight Pounds
White All-Round	6	3-1/8	1/2*	108 000 BLK**	10	2
Red All-Round	6	3-1/8	1/2*	108 R00 BLK	10	2
Green All-Round	6	3-1/8	1/2*	108 G00 BLK	10	2

\*Base Removable for Surface Mounting.

\*\*These Lights Are Supplied with a Gray Tinted Globe.

**FIGS. 112 & 309 - CERTIFIED FOR USE ON POWER DRIVEN VESSELS UNDER 20 METERS (65.6 FT.) IN LENGTH.**



**Fig. 112-B**



**Fig. 309-B**



**CONSTRUCTION:**

- \* CAST BRONZE
- \* MEDIUM SCREW BASE TYPE ELECTRICAL SOCKET
- \* FOR 12 OR 32 VOLTS, BULB NOT INCLUDED

**ORDERING INFORMATION**

Description	Height Overall Inches	O.D. Base Inches	Tapped Pipe Size Inches	Plain Bronze Standard Pkg. - 1 Pc.	Screw Size	Weight Pounds
White All-Round	8-3/4	3-1/8	---	112 B00 PLB	8	2-1/2
Red All-Round	8-3/4	3-1/8	---	112 RB0 PLB	8	2-1/2
Green All-Round	8-3/4	3-1/8	---	112 GB0 PLB	8	2-1/2
Yellow All-Round	8-3/4	3-1/8	---	112 MB0 PLB	8	2-1/2
White All-Round	6-1/2	-----	1/2	309 B00 PLB	--	2-1/4
Red All-Round	6-1/2	-----	1/2	309 RB0 PLB	--	2-1/4
Green All-Round	6-1/2	-----	1/2	309 GB0 PLB	--	2-1/4
Yellow All-Round	6-1/2	-----	1/2	309 MB0 PLB	--	2-1/4

**SPARE PARTS ORDERING INFORMATION FOR FIGS. 108, 112 & 309**

**Spare Globes:**

White, Cat. No. 106 000 WHT.  
 Gray, Cat. No. 106 000 GRY.  
 Red, Cat. No. 106 000 RED.  
 Green, Cat. No. 106 000 GRN.  
 Yellow, Cat. No. 106 000 YLW.

**Required Bulbs:**

12 Volts for Fig. 108 (2 Per card), Cat. No. 70 DP1 CLR.  
 12 Volts for White and Yellow Figs. 112 and 309, Cat. No. 340 005 FRD.  
 12 Volts for Red and Green Figs. 112 and 309, Cat. No. 340 006 FRD.  
 24 Volts for Fig. 108 (2 per Card), Cat. No. 67 DP2 CLR.  
 32 Volts for Fig. 108 (2 per Card), Cat. No. 70 DP2 CLR.  
 32 Volts for White and Yellow Figs. 112 and 309, Cat. No. 340 011 FRD.  
 32 Volts for Red and Green Figs. 112 and 309, Cat. No. 340 012 FRD.

Spare Medium Screw Base Socket, Cat. No. 226.  
 Spare Base and Gasket for Fig. 108, Cat. No. 222 DP BLK.

**FIGS. 362 & 371 - CERTIFIED FOR USE ON SAIL OR POWER DRIVEN VESSELS UNDER 20 METERS (65.6 FT.) IN LENGTH.**



**Fig. 362**



**Fig. 371**

**CONSTRUCTION:**

- \* FROSTED GLOBE, CAST BRONZE
- \* PLAIN OR CHROME PLATED
- \* DOUBLE CONTACT SOCKET, COMPLETE WITH 12 VOLT BULB



**ORDERING INFORMATION**

Vertical Height Inches	O.D. Base Inches	Plain Bronze Dealer Pkg.- 5 Cards 1 Pc. per Card	Chrome Plated Bronze Dealer Pkg.- 5 Cards 1 Pc. per Card	Screw Size	Tapped Pipe Size Inches	Weight Ounces
1-1/2	-----	362 DP PLB	362 DP CHR	-----	1/2	8
1-1/2	2-1/2	371 DP PLB	371 DP CHR	8 F.H.	-----	10

Spare Bulbs (2 per card), Cat. No. 337 011 DP  
 Spare Socket, Cat. No. 24 DP1.

Spare Globe, Cat. No. 248 000 FRD.

## REPLACEMENT WHITE ALL-ROUND LIGHTS

**FIG. 1400 - CERTIFIED FOR USE ON SAIL OR POWER DRIVEN VESSELS UNDER 20 METERS (65.6 FT.) IN LENGTH.**

### UNIVERSAL REPLACEMENT WHITE ALL-ROUND LIGHT CONSTRUCTION

- \* REPLACEMENT STOW-A-WAY PLUG-IN TYPE
- \* WHITE TRANSLUCENT GLOBE
- \* BLACK PLASTIC TOP
- \* 3/4 INCH DIAMETER ANODIZED ALUMINUM TUBE WITH LOCKING COLLAR
- \* BASES NOT INCLUDED
- \* 12 VOLT BULB INCLUDED
- \* SELECTIVE USE OF SCREW HOLES AND/OR COLLAR ALLOW FOR USE IN MULTIPLE APPLICATIONS



### ORDERING INFORMATION

Approx. Length Inches	Dealer Pkg. 1 Pc. per Card	Cards Per Package	Weight Pounds
24	1400 DP2 CHR	10	1/2
30	1400 DP3 CHR	10	5/8
36	1400 DP4 CHR	10	1-1/2
42	1400 DP5 CHR	10	1-3/4
48	1400 DP6 CHR	10	2
54	1400 DP7 CHR	10	2-1/4



Fig. 1400



Note: The 1400 Series replaces the OLD 1400 and 1600 Series replacement lights.

### CERTIFIED FOR USE ON POWER DRIVEN VESSELS UNDER 20 METERS (65.6 FT.) IN LENGTH.

**“REDUCED GLARE” REPLACEMENT ALL-ROUND LIGHTS**  
**FIG. 1440/1460- FITS PERKO STYLE VERTICAL BASES**  
**FIG. 1445/1465 - FITS PERKO STYLE BASES WITH 5° ANGLE**

### CONSTRUCTION:

- \* REPLACEMENT STOW-A-WAY PLUG-IN TYPE
- \* FIGS. 1440/1445 CLEAR FRESNEL LENS WITH BLACK PLASTIC TOP
- \* FIGS. 1460/1465 CLEAR FRESNEL LENS WITH FROSTED GLOBE & BLACK PLASTIC TOP
- \* 3/4 INCH DIAMETER ANODIZED ALUMINUM TUBE WITH LOCKING COLLAR
- \* BASES NOT INCLUDED
- \* 12 VOLT BULB INCLUDED



Fig. 1440



Fig. 1445



### ORDERING INFORMATION

Approx. Length Inches	Closed Top Style Dealer Pkg. 1 Pc. per Card	Clear Top Style Dealer Pkg. 1 Pc. per Card	Cards Per Package	Weight Pounds
24	1440 DP2 CHR	1460 DP2 CHR	10	1/2
30	1440 DP3 CHR	1460 DP3 CHR	10	5/8
36	1440 DP4 CHR	1460 DP4 CHR	10	1-1/2
42	1440 DP5 CHR	1460 DP5 CHR	10	1-3/4
48	1440 DP6 CHR	1460 DP6 CHR	5	2
54	1440 DP7 CHR	1460 DP7 CHR	5	2-1/4
24	1445 DP2 CHR	1465 DP2 CHR	10	1/2
30	1445 DP3 CHR	1465 DP3 CHR	10	5/8
36	1445 DP4 CHR	1465 DP4 CHR	10	1-1/2
42	1445 DP5 CHR	1465 DP5 CHR	10	1-3/4
48	1445 DP6 CHR	1465 DP6 CHR	5	2
54	1445 DP7 CHR	1465 DP7 CHR	5	2-1/4



Fig. 1460

See Page 20 for Features



Fig. 1465



**NEW PRODUCT**



## SPARE BASES FOR POLE LIGHTS

### FIG. 1045, 1059-P & 1060-P - PLUG-IN TYPE, WATERPROOF SNAP-ON COVER



**FIG. 1045 P00**



**FIG. 1060 PBO**



**FIG. 1059 P00**

**FIG. 1045 P00 - FITS FIGS. 940, 970, 1211\*, 1612, 1631 & 1650 SERIES**  
**FIG. 1059 P00 - FITS FIGS. 1330 & 1630 SERIES**  
**FIG. 1060 PBO - FITS FIGS. 1212\* & 1430 SERIES**

**LOCKING COLLAR IS INCLUDED WITH BASE TO ALLOW INTERCHANGEABILITY WITH DISCONTINUED STYLE BASES**



#### ORDERING INFORMATION

Length Overall Inches	Width Overall Inches	Insert Type	Replaces Cat. No.	Dealer Pkg. - 5 Cards 1 Pc. per Card	Tube Angle Degrees
2-1/4 O.D.	----	None	1023 P00 CHR	1045 P00 DP	0
3-3/4	1-5/8	None	1330 000 99A	1059 P00 DP	16
3-3/4	1-5/8	None	1026 P00 CHR	1059 P00 DP	16
3-3/4	1-3/4	Black	1027 PBO CHR	1060 PBO DP	5
3-3/4	1-3/4	Teak**	1027 PT0 CHR	1060 PBO DP	5

\*Specify 3-Contact Base (e.g., 1045 300 DP for Fig. No. 1211 or 1060 3B0 DP for Fig. No.1212).

\*\*Teak Insert Bases No Longer Available, Substitute Black Insert Bases.

### FIG. 1059-T & 1060-T - TELESCOPING TYPE

**FIG. 1059 T00 - FITS FIG. 1311 & 1611 SERIES**

**FIG. 1060 TBO - FITS FIG. 1411 SERIES**

**LOCKING COLLAR IS INCLUDED WITH BASE TO ALLOW INTERCHANGEABILITY WITH DISCONTINUED STYLE BASES**



#### ORDERING INFORMATION

Length Overall Inches	Width Overall Inches	Insert Type	Replaces Cat. No.	Dealer Pkg. - 5 Cards 1 Pc. per Card	Tube Angle Degrees
3-3/4	1-5/8	None	1156 000 CHR	1059 T00 DP	16
3-3/4	1-5/8	None	1026 T00 CHR	1059 T00 DP	16
3-3/4	1-3/4	Black	1027 TBO CHR	1060 TBO DP	5
3-3/4	1-3/4	Teak**	1027 TT0 CHR	1060 TBO DP	5

\*\*Teak Insert Bases No Longer Available, Substitute Black Insert Bases.



**FIG. 1059 T00**



**FIG. 1060 TBO**

### FIG. 1046 & 1047 - PLUG-IN TYPE, WATER RESISTANT SLIDE COVER

**FIG. 1046 P00 - FITS FIG. 1640 SERIES**

**FIG. 1047 P00 - FITS FIG. 1296\* & 1660 SERIES**



**FIG. 1046**



**FIG. 1047**

#### ORDERING INFORMATION

Length Overall Inches	Width Overall Inches	Dealer Pkg. - 5 Cards 1 Pc. per Card	Tube Angle Degrees
3-1/2	1-1/2	1047 P00 DP	0
3-1/2	1-1/2	1046 P00 DP	5

\*Specify 3-Contact Base, Cat. No. 1047 3B0 DP.

### FIG. 1125-99A & 1209-99A - PLUG-IN TYPE, WATERPROOF SCREW-ON CAP

**FIG. 1125-99A - FITS FIG. 1125**

**FIG. 1209-99A - FITS FIG. 1209 SERIES**



**FIG. 1125-99A & 1209-99A**

#### ORDERING INFORMATION

Length Overall Inches	Width Overall Inches	Dealer Pkg. - 5 Cards 1 Pc. per Card	Tube Angle Degrees
3-3/8	2-1/4	1125 DP 99A	16
3-3/8	2-1/4	1209 DP 99A	16

## SPARE BASES, BRACKETS FOR WINDSHIELD MOUNT LIGHTS

NAVIGATION LIGHTS FOR VESSELS UNDER 20 METERS

**FIG. 1048 - PLUG-IN TYPE WITH WATERPROOF SNAP-ON COVER**  
**FOR POLES WITH THREADED COLLARS**  
**FITS FIGS. 1621 & 1655 SERIES**



**ORDERING INFORMATION**

Length Overall Inches	Width Overall Inches	Dealer Pkg. - 5 Cards 1 Pc. per Card	Tube Angle Degrees
3-1/2	2	1048 P00 DP	5



**FIG. 1048**

**FIGS. 1052/1052A & 1054/1054A - FOLD-DOWN, ADJUSTABLE ANGLE BASE WITH PLASTIC ADAPTERS FOR "V" OR FLAT MOUNTING SURFACES. COMPLETE WITH KNOB AND END PLUG.**

**FIGS. 1052, 1052A, 1054 & 1054A**  
**CONSTRUCTION:**

**\* CHROME PLATED ZINC ALLOY**

**FIGS. 1052/1054 - DOES NOT CONTAIN NOTCH FOR THROUGH BASE WIRING**  
**FIG. 1052 - HORIZONTAL MOUNT, FITS FIGS. 1134 & 1634**  
**FIG. 1054 - VERTICAL MOUNT, FITS FIGS. 1137 & 1637**

**FIGS. 1052A/1054A - CONTAINS NOTCH FOR THROUGH BASE WIRING**  
**FIG. 1052A - HORIZONTAL MOUNT, FITS FIGS. 1181 & 1281**  
**FIG. 1054A - VERTICAL MOUNT, FITS FIGS. 1184 & 1284**

**FIGS. 1052B & 1054B**  
**CONSTRUCTION:**

**\* BLACK PLASTIC.**

**FIGS. 1052B/1054B - CONTAINS NOTCH FOR THROUGH BASE WIRING**  
**UNIVERSAL MOUNTING BASE FITS ALL FOLD DOWN SERIES POLES**  
**FIGS. 1052B - HORIZONTAL MOUNT**  
**FIGS. 1054B - VERTICAL MOUNT**



**FIG. 1052**



**FIG. 1054**



**FIG. 1052A**



**FIG. 1054A**



**ORDERING INFORMATION**

Construction	Length Overall Inches	Width Overall Inches	Replaces Cat. No.	Dealer Pkg. - 5 Cards 1 Pc. per Card
Chr. Plated Zinc Alloy	2	1-1/2	1120 000 CHR	1052 DP CHR
Chr. Plated Zinc Alloy	2-1/4	5/8	1122 000 CHR	1054 DP CHR
Chr. Plated Zinc Alloy	2	1-1/2	1120 000 CHR	1052 DPA CHR
Chr. Plated Zinc Alloy	2-1/4	5/8	1122 000 CHR	1054 DPA CHR
Black Plastic	2	1-1/2	1120 000 CHR	1052 DPB BLK
Black Plastic	2-1/4	5/8	1122 000 CHR	1054 DPB BLK



**FIG. 1052B**

**IMPROVED ADJUSTABILITY**



**FIG. 1054B**

**FIGS. 1123-99A & 1124-99A - PLUG-IN TYPE, WATERPROOF SCREW-ON CAP WITH PLASTIC ADAPTERS FOR "V" OR FLAT MOUNT**

**FIG. 1123 - HORIZONTAL MOUNT, FITS FIGS. 1123 & 1273 SERIES**  
**FIG. 1124 - VERTICAL MOUNT, FITS FIGS. 1124 & 1274 SERIES**



**ORDERING INFORMATION**

Dimensions Bracket Inches	Dealer Pkg. - 5 Cards 1 Pc. per Card
2-1/4 x 3/4	1123 DP 99A
3/4 x 2-1/4	1124 DP 99A



**FIG. 1123-99A**



**FIG. 1124-99A**

## SPARE PARTS

FOR NAVIGATION LIGHTS ON VESSELS UNDER 20 METERS (65.6 FT.) IN LENGTH



Fig. 291



Fig. 138



Fig. 290

### FIGS. 138, 290 & 291 - ELECTRIC ADAPTERS

FIGS. 138 & 290 - BRASS SPRING TYPE FOR DOUBLE ENDED BULBS

FIG. 291 - FOR DOUBLE CONTACT BAYONET BASE BULB

#### ORDERING INFORMATION

O.D. Overall Inches	I.D. Light Opening Inches	Height Overall Inches	Standard Pkg. - 1 Pc.	Used With Light Series
2-3/16	1-7/8	3-3/4	138 F03	91, 98 & 99
4-1/2	3-3/16	4-3/4	290 F02	4, 5, 7, F02
4-1/2	3-3/16	5-1/4	290 F03	4, 5, 7, F03
3-5/8	3-3/16	2-5/8	291 003 PLB	06A

### FIGS. 52 & 276 - DOUBLE CONTACT BAYONET SOCKETS

BRASS, WITH 6 INCH WIRE LEADS - FIG. 276 TAPPED FOR 1/8 INCH PIPE



Fig. 52



Fig. 276



#### ORDERING INFORMATION

Length Overall Inches	Standard Pkg. - 5 Pcs.	Dealer Pkg. - 10 Cards 1 Pc. per Card
1	-----	52 DP
1-1/2	276 000	
2	276 002	
2-3/8	276 003	

### FIG. 24 - DOUBLE CONTACT BAYONET SOCKET

BLACK PLASTIC BODY



Fig. 24



#### ORDERING INFORMATION

Length Pigtail Inches	O.D. Inches	Dealer Pkg. - 10 Cards 1 Pc. per Card
10	3/4	24 DP1
60	3/4	24 DP2

### FIG. 1109 - SINGLE CONTACT BAYONET SOCKET - BRASS



Fig. 1109



#### ORDERING INFORMATION

Length Pigtail Inches	Length Socket Inches	O.D. Inches	Dealer Pkg. - 10 Cards 1 Pc. per Card
6	5/8	3/8	1109 DP

### FIG. 230 - LAMP CHIMNEY - GLASS



Fig. 230

#### ORDERING INFORMATION

O.D. Base Inches	Height Overall Inches	Standard Pkg. - 5 Pcs.
1-1/2	4-3/4	230 000 CLR

## SPARE BULBS FOR NAVIGATION LIGHTS

FOR NAVIGATION LIGHTS ON VESSELS UNDER 20 METERS (65.6 FT.) IN LENGTH

NAVIGATION LIGHTS FOR VESSELS UNDER 20 METERS

**FIG. 337 - DOUBLE CONTACT BAYONET BASE BULB**

**ORDERING INFORMATION**

Nominal Voltage	Wattage	Amps	Dealer Pkg. 5 cards	Bulbs per card	Diameter Inches	Lamp No.
12	7	.58	337 011 DP	2	3/4	90
12	11	.94	337 012 DP	2	3/4	1004
24	15	.63	337 014 DP	1	1	306
32	13	.40	337 018 DP	1	3/4	624

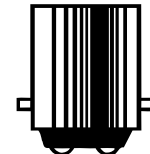

**FIG. 337**



**FIG. 375 - DOUBLE CONTACT BAYONET INDEXING BASE BULB**

**ORDERING INFORMATION**

Nominal Voltage	Wattage	Amps	Standard Pkg. - 1 bulb
12	10	.83	375 12V 10W
12	25	2.08	375 12V 25W
24	10	.42	375 24V 10W
24	25	1.04	375 24V 25W
32	10	.31	375 32V 10W
32	25	.78	375 32V 25W

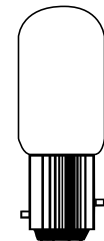

**FIG. 375**

**FIG. 340 - MEDIUM SCREW BASE BULB**

**ORDERING INFORMATION**

Nominal Voltage	Wattage	Amps	Standard Pkg. - 6 bulbs	Type	L.C.L. Inches	Lamp No.
12	15	1.25	340 005 FRD	A-17	2-3/8	15-A
12	25	2.08	340 006 FRD	A-19	2-9/16	25-A
32	15	.47	340 011 FRD	A-17	2-3/8	15-A
32	25	.78	*340 012 FRD	A-19	2-9/16	25-A

\*Standard Pkg. - 2 bulbs

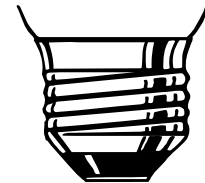

**FIG. 340**



**FIG. 338 WEDGE BASE BULBS**

**ORDERING INFORMATION**

Nominal Voltage	Wattage	Amps	Dealer Pkg. - 5 cards 2 Bulbs per card	Bulb Diameter Inches	Bulb Length Inches
12	5	.35	338 DP1 CLR	13/32	1-1/16
12	9	.69	338 DP2 CLR	5/8	1-1/2

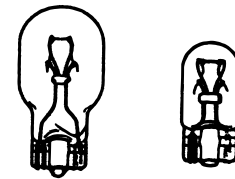

**FIG. 338 #2 FIG. 338 #1**



**FIGS. 67, 69, 70, 71 & 72 FESTOON BULBS - DOUBLE ENDED**

**ORDERING INFORMATION**

Nominal Voltage	Wattage	Amps	Dealer Pkg. - 5 cards 2 Bulbs per card	Bulb Diameter Inches	Bulb Length Inches
12	8	.70	71 DP8 CLR	3/8	1-1/8
12	10	.83	69 DP CLR	3/8	1-5/8
12	10	.74	70 DP0 CLR	3/8	1-11/16
12	15	.97	70 DP1 CLR	9/16	1-11/16
12	10	.80	71 DP CLR	3/8	1-1/8
24	8	.35	72 DP8 CLR	3/8	1-1/8
24	10	.42	67 DP1 CLR	3/8	1-11/16
24	18	.75	67 DP2 CLR	9/16	1-11/16
24	10	.40	72 DP1 CLR	3/8	1-1/8
32	12	.40	70 DP2 CLR	3/8	1-5/8



**FIG. 67**

**FIG. 69**

**FIG. 70**

**FIG. 71**

**FIG. 72**







## U.S. COAST GUARD REGULATIONS

### FOR NAVIGATION LIGHTS ON VESSELS OVER 20 METERS (65.6 FT.) IN LENGTH.

On March 31, 1977, the U.S. Coast Guard published in the Federal Register, an amendment to the navigation and navigable water regulations, which added a new subchapter DD, (33CFR 87). This subchapter contains rules implementing and interpreting the International Regulations for Preventing Collisions at Sea, 1972 ('72 COLREGS). The International Regulations for Preventing Collisions at Sea, 1960, were replaced by the '72 COLREGS at 1200 hours, zone time on July 15, 1977. Therefore, all vessels on the high seas must comply with the '72 COLREGS at this time. In addition, with the enactment of the U.S. Inland Navigation Rules Act of 1980, the Inland Rules, Western Rules, and Great Lakes Rules were unified into a single set of requirements. The effective date for this legislation was December 24, 1981 (March 1, 1983 for Great Lakes). Therefore, all vessels must comply with these rules at this time.

Rules 21 and 22 of the '72 COLREGS and the U.S. Inland Navigation Rules give the color and range requirements for various navigation lights. Annex 1 to the '72 COLREGS and the U.S. Inland Navigation Rules gives positioning and technical details for these lights.

### U.S. COAST GUARD ACCEPTANCE OF NAVIGATION LIGHTS

All U.S. Registered vessels are subject to either the '72 COLREGS or the U.S. Inland Rules. The U.S. Coast Guard is accepting lights that have passed the U.L. tests (U.L. Standard 1104) as meeting the '72 COLREGS and the U.S. Inland Rules for vessels over 20 meters (65.6 ft.) in length. U.S. requirements for smaller vessels are less strict. As the first domestic manufacturer to pass U.L. 1104, PERKO's lights can be installed on vessels over 20 meters (65.6 ft.) in length. Some models are designed for use on vessels over 20 meters (65.6 ft.) in length, while others are designed for use on vessels 20 meters (65.6 ft.) to 50 meters (164.0 ft.) in length.

A brass tag is permanently affixed to the light indicating the type of light, catalog no., voltage and bulb type to install to meet the visibility requirements. It also states that the light is classified by U.L. in accordance with the '72 COLREGS. This is the only documentation needed by a vessel for navigation lights to certify light construction compliance with the '72 COLREGS and the Inland Navigation Rules, and eliminates the former "Certificate of Compliance".



### EACH LIGHT HAS ITS OWN SERIAL NO. FOR IDENTIFICATION.

The lights indicated for use on vessels over 20 meters (65.6 ft.) in length have passed U.L. 1104. The facsimile of the tag shown above is used on our cast bronze lights. Similar rectangular tags are used on other style lights.

Please note that any changes made to PERKO Navigation lights, including substitution of bulbs other than those shown in our catalog, instruction sheets, or metal tags (affixed to some lights) will void all certifications and U.S. Coast Guard acceptance.

For the present, the U.S. Coast Guard will not publish a list of U.L. classified lights. However, field offices have been notified. For more detailed information, consult the complete '72 COLREGS, the U.S. Inland Navigation Rules, and your local U.S. Coast Guard office.

### SPECIAL PURPOSE LIGHTS

Other lights (not shown) for use where the vessel is subject to special local requirements are available. Contact PERKO for further information.

## SINGLE LENS NAVIGATION LIGHTS

**Figs. 1369 - 1372 SERIES - CERTIFIED FOR USE ON VESSELS OVER 20 METERS (65.6 FT.) IN LENGTH.**



### CONSTRUCTION:

- \* **ULTRA LIGHTWEIGHT, TOUGH FIBER-FILLED POLYCARBONATE BLACK PLASTIC**
- \* **COMPLETE WITH A PRE-WIRED MEDIUM PREFOCUS SOCKET**
- \* **INCLUDES ONE 3 FOOT LENGTH OF 16/3-SO CABLE THROUGH WATERTIGHT TERMINAL TUBES**
- \* **WATERTIGHT ACCESS CAP FOR REBULBING AND CLEANING**
- \* **24, 120 & 220 VOLT OPTIONS**
- \* **ROUGH SERVICE BULBS ARE AVAILABLE**



**NEW PRODUCT**

### ORDERING INFORMATION

Description	Height Overall Inches	Height Lens Inches	Weight Pounds	Visibility Arc	Visibility Miles	Single Stack Cat. No.	Mounting Bolt Size Inches
Red Side Light	9-1/4	6-3/4	5-1/8	112-1/2°	3	1372 RE0 BLK	3/8
Green Side Light	9-1/4	6-3/4	5-1/8	112-1/2°	3	1372 GE0 BLK	3/8
White Masthead Light	9-1/4	6-3/4	5-1/8	225°	6	1373 E00 BLK	3/8
White Stern Light**	9-1/4	6-3/4	5-1/8	135°	3	1374 E00 BLK	3/8
Yellow Towing Light	9-1/4	6-3/4	5-1/8	135°	3	1374 ME0 BLK	3/8
* White All-Round Light**	9-1/4	6-3/4	5-1/8	360°	3	1369 E00 BLK	3/8
* White All-Round Light***	9-1/4	6-3/4	5-1/8	360°	6	1369 HE0 BLK	3/8
Red All-Round Light	9-1/4	6-3/4	5-1/8	360°	3	1370 RE0 BLK	3/8
Green All-Round Light	9-1/4	6-3/4	5-1/8	360°	3	1370 GE0 BLK	3/8
Yellow All-Round Light	9-1/4	6-3/4	5-1/8	360°	3	1370 ME0 BLK	3/8

Special lights to meet local requirements are available upon request.

\* Not Pictured

\*\*These lights are supplied with a Gray Tinted Lens.

\*\*\*For Great Lakes use.



**Fig. 1372  
Green Side Light**

**Fig. 1370  
Green  
All-Round**



**Fig. 1370  
Red  
All-Round**



**Fig. 1372  
Red Side Light**



**Fig. 1373  
White Masthead**



**Fig. 1370  
Yellow All-Round**



**Fig. 1374  
White Stern**

### IMPORTANT BULB DATA

**TO COMPLY WITH THE U.L. STANDARD 1104, THE LIGHTS LISTED ON THIS PAGE MUST BE USED WITH THE FOLLOWING PERKO CATALOG NUMBERS: 24 VOLT USE CAT. No. 342 024 CLR, 120 VOLT USE CAT. No. 342 004 CLR BULB OR 342 RS4 CLR BULB WHEN A "ROUGH SERVICE" BULB IS REQUIRED AND 220 VOLT USE CAT. No. 342 220 CLR.**

NAVIGATION LIGHTS FOR VESSELS OVER 20 METERS

## DOUBLE LENS NAVIGATION LIGHTS

**FIGS. 1364 - 1368 SERIES - CERTIFIED FOR USE ON VESSELS OVER 20 METERS (65.6 FT.) IN LENGTH.**



### CONSTRUCTION:

- \* **ULTRA LIGHTWEIGHT, TOUGH FIBER-FILLED POLYCARBONATE BLACK PLASTIC**
- \* **COMPLETE WITH A PRE-WIRED MEDIUM PREFOCUS SOCKET**
- \* **INCLUDES TWO 3 FOOT LENGTHS OF 16/3-SO CABLE THROUGH WATERTIGHT TERMINAL TUBES**
- \* **WATERTIGHT ACCESS CAP FOR REBULBING AND CLEANING**
- \* **24, 120 & 220 VOLT OPTIONS**
- \* **ROUGH SERVICE BULBS ARE AVAILABLE**

**NEW PRODUCT**

NAVIGATION LIGHTS FOR VESSELS OVER 20 METERS

### ORDERING INFORMATION

Description	Height Overall Inches	Height Lens Inches	Weight Pounds	Visibility Arc	Visibility Miles	Double Stack Cat. No.	Mounting Bolt Size Inches
Red Side Light	17-1/4	6-3/4	10-1/2	112-1/2°	3	1364 RE0 BLK	3/8
Green Side Light	17-1/4	6-3/4	10-1/2	112-1/2°	3	1364 GE0 BLK	3/8
* White Masthead Light	17-1/4	6-3/4	10-1/2	225°	6	1365 E00 BLK	3/8
* White Stern Light*	17-1/4	6-3/4	10-1/2	135°	3	1366 E00 BLK	3/8
Yellow Towing Light	17-1/4	6-3/4	10-1/2	135°	3	1366 ME0 BLK	3/8
* White All-Round Light**	17-1/4	6-3/4	10-1/2	360°	3	1367 E00 BLK	3/8
White All-Round Light***	17-1/4	6-3/4	10-1/2	360°	6	1367 HE0 BLK	3/8
Red All-Round Light	17-1/4	6-3/4	10-1/2	360°	3	1368 RE0 BLK	3/8
* Green All-Round Light	17-1/4	6-3/4	10-1/2	360°	3	1368 GE0 BLK	3/8
* Yellow All-Round Light	17-1/4	6-3/4	10-1/2	360°	3	1368 ME0 BLK	3/8

Special lights to meet local requirements are available upon request.

\* Not Pictured

\*\*These lights are supplied with a Gray Tinted Lens.

\*\*\*For Great Lakes use.



**Fig. 1364  
Green Side Light**



**Fig. 1368  
Red All-Round**



**Fig. 1366  
Yellow Towing**



**Fig. 1367  
White All-Round**



**Fig. 1364  
Red Side Light**

### IMPORTANT BULB DATA

**TO COMPLY WITH THE U.L. STANDARD 1104, THE LIGHTS LISTED ON THIS PAGE MUST BE USED WITH THE FOLLOWING PERKO CATALOG NUMBERS: 24 VOLT USE CAT. No. 342 024 CLR, 120 VOLT USE CAT. No. 342 004 CLR BULB OR 342 RS4 CLR BULB WHEN A "ROUGH SERVICE" BULB IS REQUIRED AND 220 VOLT USE CAT. No. 342 220 CLR.**

## SINGLE LENS NAVIGATION LIGHTS

**FIGS. 1169 - 1172 SERIES - CERTIFIED FOR USE ON VESSELS OVER 20 METERS (65.6 FT.) IN LENGTH.**



### CONSTRUCTION:

- \* **CAST BRONZE**
- \* **PRE-WIRED MEDIUM PREFOCUS SOCKET.**
- \* **3 FEET OF 16/3-SO CABLE THROUGH A WATERTIGHT TERMINAL TUBE**
- \* **WATERTIGHT ACCESS CAP FOR REBULBING AND CLEANING**
- \* **120 VOLT BULB NOT INCLUDED**
- \* **ROUGH SERVICE BULBS ARE AVAILABLE**

### ORDERING INFORMATION

Description	Height Overall Inches	Height Lens Inches	Weight Pounds	Visibility Arc	Visibility Miles	Single Stack Cat. No.	Mounting Bolt Size Inches
Red Side Light	9-1/4	6-3/4	11-1/8	112-1/2°	3	1172 RE0 PLB	3/8
Green Side Light	9-1/4	6-3/4	11-1/8	112-1/2°	3	1172 GE0 PLB	3/8
White Masthead Light	9-1/4	6-3/4	11-1/8	225°	6	1173 E00 PLB	3/8
White Stern Light**	9-1/4	6-3/4	11-1/8	135°	3	1174 E00 PLB	3/8
Yellow Towing Light	9-1/4	6-3/4	11-1/8	135°	3	1174 ME0 PLB	3/8
White All-Round Light**	9-1/4	6-3/4	11-1/8	360°	3	1169 E00 PLB	3/8
White All-Round Light***	9-1/4	6-3/4	11-1/8	360°	6	1169 HE0 PLB	3/8
Red All-Round Light	9-1/4	6-3/4	11-1/8	360°	3	1170 RE0 PLB	3/8
Green All-Round Light	9-1/4	6-3/4	11-1/8	360°	3	1170 GE0 PLB	3/8
Yellow All-Round Light	9-1/4	6-3/4	11-1/8	360°	3	1170 ME0 PLB	3/8

Special lights to meet local requirements are available upon request.

\*\*These lights are supplied with a Gray Tinted Lens.

\*\*\*For Great Lakes use.

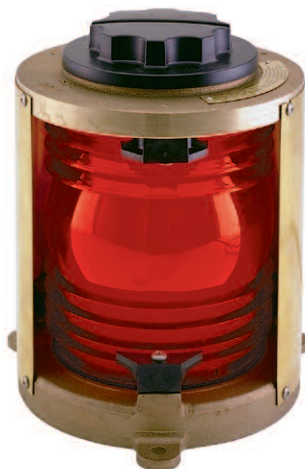

**Fig. 1172**

### IMPORTANT BULB DATA

**To comply with U.L. STANDARD 1104, THE LIGHTS LISTED ON THIS PAGE MUST USE A PERKO Cat. No. 342 004 CLR BULB.**

### SPARE PARTS ORDERING INFORMATION

#### Spare Lenses:

Red, Cat. No. 261 001 RED  
 Green, Cat. No. 261 001 GRN  
 White, Cat. No. 261 001 CLR  
 Gray, Cat. No. 261 001 GRY  
 Yellow, Cat. No. 261 001 YLW

Spare Lens Gasket, Cat. No. 1143.  
 Spare O-Ring for Cap, Cat. No. 1119.  
 Spare Medium Prefocus Socket, Cat. No. 347.  
 Spare Lens Retaining Clip with Bolt, Cat. No. 1133.  
 Spare Access Cap, O-Ring and Retainer, Cat. No. 1105 000 BLK.

NAVIGATION LIGHTS FOR VESSELS OVER 20 METERS

## DOUBLE LENS NAVIGATION LIGHTS

**FIGS. 1164 - 1168 SERIES - CERTIFIED FOR USE ON VESSELS OVER 20 METERS (65.6 FT.) IN LENGTH.**



### CONSTRUCTION:

- \* **CAST BRONZE**
- \* **PRE-WIRED MEDIUM PREFOCUS SOCKET IN EACH COMPARTMENT**
- \* **TWO 3 FEET LENGTHS OF 16/3-SO CABLE THROUGH A WATERTIGHT TERMINAL TUBE**
- \* **WATERTIGHT ACCESS CAP FOR REBULBING AND CLEANING**
- 120 VOLT BULB NOT INCLUDED**
- \* **ROUGH SERVICE BULBS ARE AVAILABLE**

### ORDERING INFORMATION

Description	Height Overall Inches	Height Lens Inches	Weight Pounds	Visibility Arc	Visibility Miles	Double Stack Cat. No.	Mounting Bolt Size Inches
Red Side Light	17-1/4	6-3/4	17	112-1/2°	3	1164 RE0 PLB	3/8
Green Side Light	17-1/4	6-3/4	17	112-1/2°	3	1164 GE0 PLB	3/8
White Masthead Light	17-1/4	6-3/4	17	225°	6	1165 E00 PLB	3/8
White Stern Light*	17-1/4	6-3/4	17	135°	3	1166 E00 PLB	3/8
Yellow Towing Light	17-1/4	6-3/4	17	135°	3	1166 ME0 PLB	3/8
White All-Round Light**	17-1/4	6-3/4	17	360°	3	1167 E00 PLB	3/8
White All-Round Light***	17-1/4	6-3/4	17	360°	6	1167 HE0 PLB	3/8
Red All-Round Light	17-1/4	6-3/4	17	360°	3	1168 RE0 PLB	3/8
Green All-Round Light	17-1/4	6-3/4	17	360°	3	1168 GE0 PLB	3/8
Yellow All-Round Light	17-1/4	6-3/4	17	360°	3	1168 ME0 PLB	3/8

Special lights to meet local requirements are available upon request.

\*\*These lights are supplied with a Gray Tinted Lens.

\*\*\*For Great Lakes use.



**Fig. 1164**

### IMPORTANT BULB DATA

**To comply with U.L. STANDARD 1104, THE LIGHTS LISTED ON THIS PAGE MUST USE A PERKO Cat. No. 342 004 CLR BULB.**

#### Spare Lenses:

Red, Cat. No. 261 001 RED  
 Green, Cat. No. 261 001 GRN  
 White, Cat. No. 261 001 CLR  
 Gray, Cat. No. 261 001 GRY  
 Yellow, Cat. No. 261 001 YLW

#### SPARE PARTS ORDERING INFORMATION

Spare Lens Gasket, Cat. No. 1143.  
 Spare O-Ring for Cap, Cat. No. 1119.  
 Spare Dual Medium Prefocus Socket Assembly, Cat. No. 303.  
 Spare Lens Retaining Clip with Bolt, Cat. No. 1133.  
 Spare Plastic Cap, O-Ring and Retainer, Cat. No. 1105 000 BLK.

## NAVIGATION LIGHTS - TECHNICAL INFORMATION

Fig. Nos. 1364 to 1374 Series Single & Double Lens Navigation Light Technical Information (See Lights on Page 42 & 43)

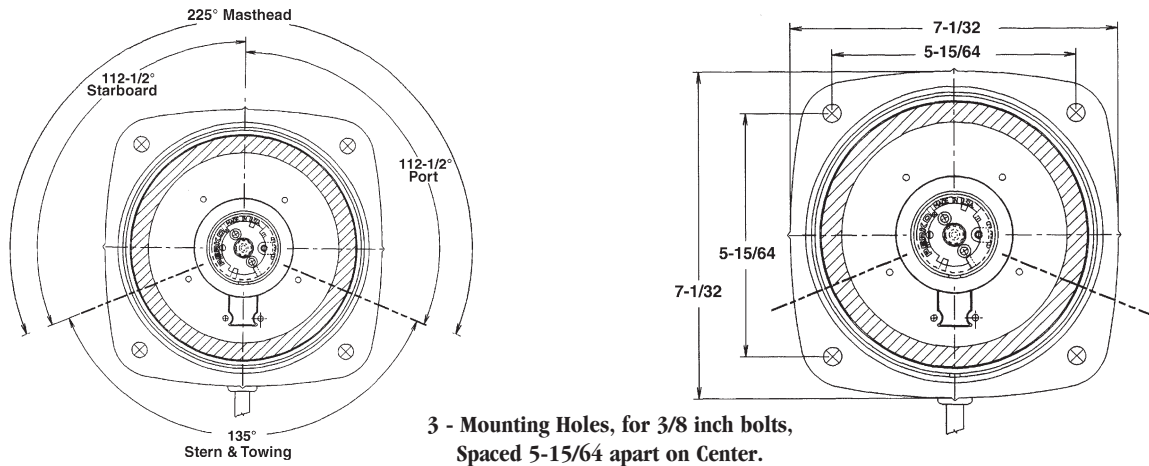

Fig. Nos. 1369 to 1374 Series Single Lens Navigation Light Technical Information (See Lights on Page 42)

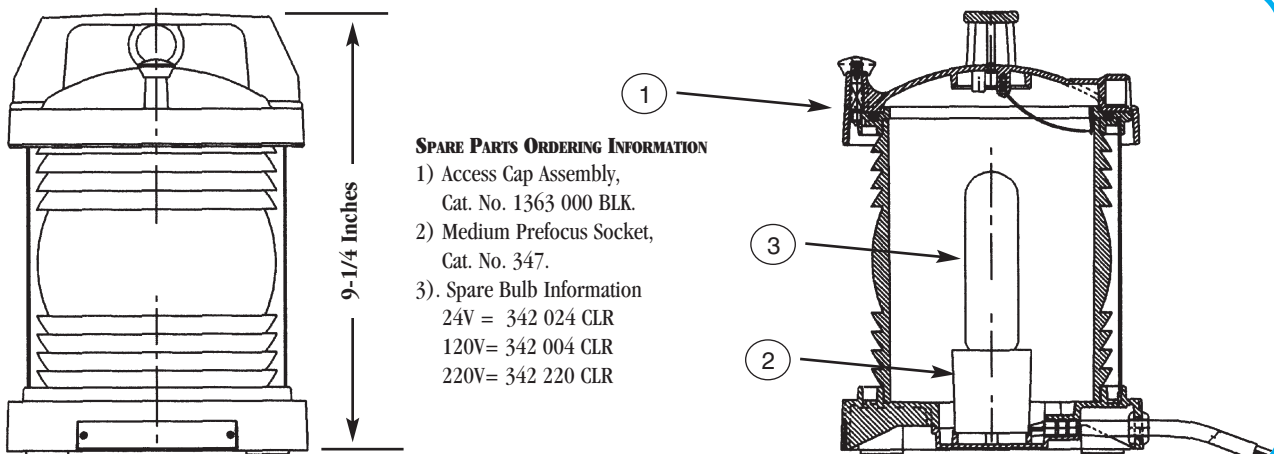
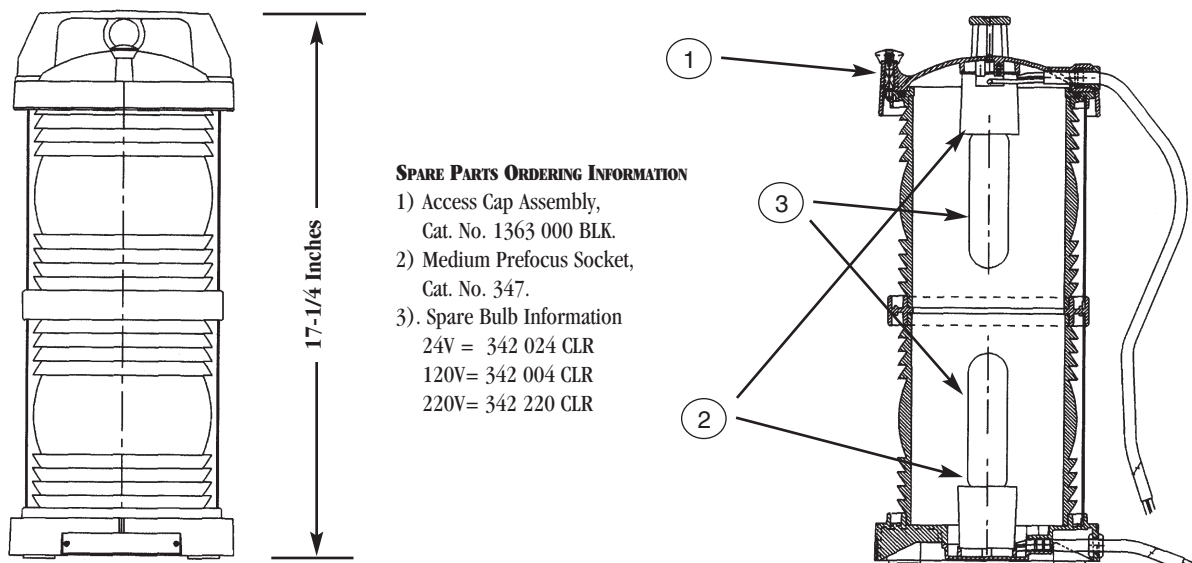

Fig. Nos. 1364 to 1368 Series Double Lens Navigation Light Technical Information (See Lights on Page 43)



NAVIGATION LIGHTS FOR VESSELS OVER 20 METERS

## NAVIGATION LIGHTS - TECHNICAL INFORMATION

Fig. Nos. 1127 to 1130 Series Navigation Light Technical Information (See Lights on Page 48)

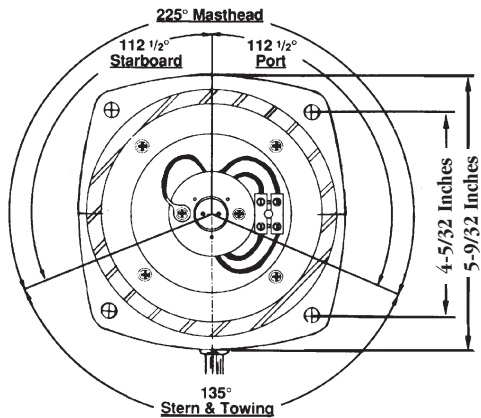

4 - Mounting Holes, for 1/4 inch bolts  
Spaced 90° Apart, on a 5-13/16 Inch Diameter Circle.

### SPARE PARTS ORDERING INFORMATION

- 1) Access Cap, O-Ring and Retainer, Cat. No. 1105 000 BLK.
- 2) O-Ring for Cap, Cat. No. 1119.
- 3) Lens Assembly:  
Red, Cat. No. 249 000 RED.  
Green, Cat. No. 249 000 GRN.  
White, Cat. No. 249 000 CLR.  
Gray, Cat. No. 249 000 GRY.  
Yellow, Cat. No. 249 000 YLW.
- 4) Double Contact Socket, Cat. No. 134.

Required Bulbs:  
12 Volts, Cat. No. 374 001 CLR.  
24 Volts, Cat. No. 374 002 CLR.  
32 Volts, Cat. No. 374 003 CLR.  
120 Volts, Cat. No. 374 004 CLR.

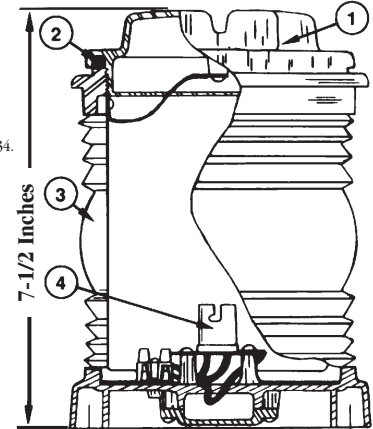
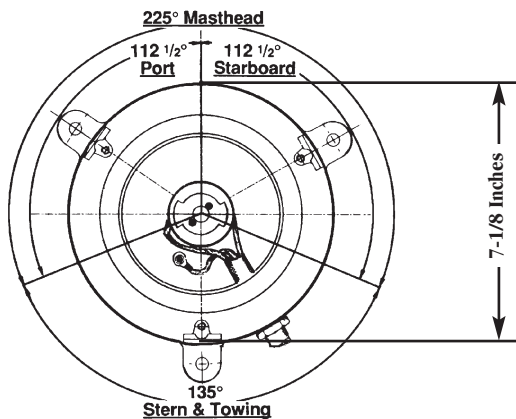

Fig. Nos. 1169 to 1174 Series Single Lens Navigation Light Technical Information (See Lights on Page 44)



3 - Mounting Holes, for 3/8 inch bolts,  
Spaced 120° apart, on a 8-1/8 inch Diameter Circle

### SPARE PARTS ORDERING INFORMATION

- 1) Access Cap, O-Ring and Retainer, Cat. No. 1105 000 BLK.
- 2) O-Ring for Cap, Cat. No. 1119.
- 3) Lens Gasket, Cat. No. 1143.
- 4) Spare Lenses:  
Red, Cat. No. 261 001 RED.  
Green, Cat. No. 261 001 GRN.  
White, Cat. No. 261 001 CLR.  
Gray, Cat. No. 261 001 GRY.  
Yellow, Cat. No. 261 001 YLW.
- 5) Lens Retaining Clip with Bolt, Cat. No. 1133.
- 6) Medium Prefocus Socket, Cat. No. 347.

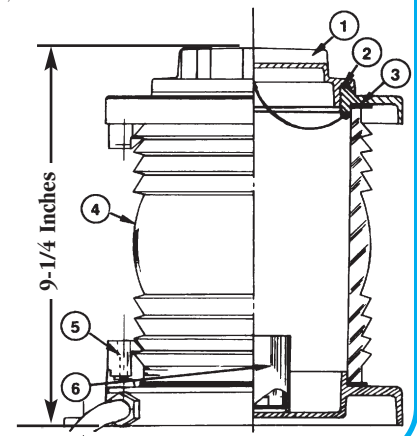
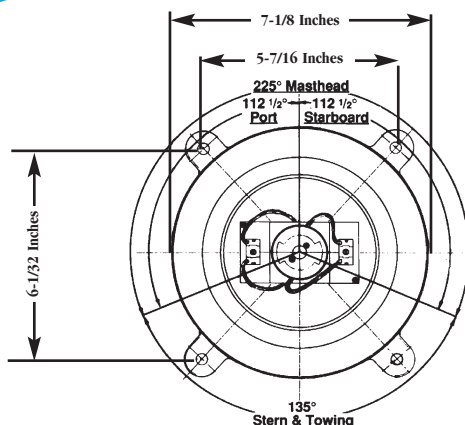

Fig. Nos. 1164 to 1168 Series Double Lens Navigation Light Technical Information (See Lights on Page 45)



4 - Mounting Holes, for 3/8 inch bolts,  
on a 8-1/8 inch Diameter Circle, Spaced as shown above

### SPARE PARTS ORDERING INFORMATION

- 1) Access Cap, O-Ring and Retainer, Cat. No. 1105 000 BLK.
- 2) O-Ring for Cap, Cat. No. 1119.
- 3) Lens Gasket, Cat. No. 1143.
- 4) Spare Lenses:  
Red, Cat. No. 261 001 RED.  
Green, Cat. No. 261 001 GRN.  
White, Cat. No. 261 001 CLR.  
Gray, Cat. No. 261 001 GRY.  
Yellow, Cat. No. 261 001 YLW.
- 5) Lens Retaining Clip with Bolt, Cat. No. 1133.
- 6) Dual Medium Prefocus Socket Assembly, Cat. No. 303.
- 7) Male Electrical Plug, Cat. No. 303 A00.
- 8) Female Electrical Receptacle, Cat. No. 303 B00.

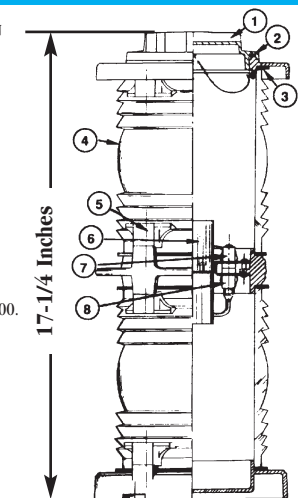

## NAVIGATION LIGHTS



**FIGS. 1127 - 1130 SERIES - CERTIFIED FOR USE ON VESSELS 20 METERS (65.6 FT.) TO 50 METERS (164.0 FT.) IN LENGTH.**

**CONSTRUCTION:**

- \* **BLACK PLASTIC**
- \* **PRE-WIRED DOUBLE CONTACT SOCKET AND 3 FEET OF 16/3-SO CABLE**
- \* **FOR 12, 24, 32 OR 120 VOLTS. BULB NOT INCLUDED**
- \* **WATERTIGHT ACCESS CAP FOR REBULBING AND CLEANING**



Height Overall	Height Lens	Screw Size	Weight Pounds
Inches	Inches		
7-1/2	4-1/2	1/4	3-1/8

**ORDERING INFORMATION**

Description	Visibility Arc	Visibility Miles	Catalog Number
Red Side Light	112-1/2°	2	1127 RA0 BLK
Green Side Light	112-1/2°	2	1127 GA0 BLK
White Masthead Light	225°	5	1128 A00 BLK
White Stern Light*	135°	2	1129 A00 BLK
Yellow Towing Light	135°	2	1129 MA0 BLK
White All-Round Light*	360°	2	1130 A00 BLK
White All-Round Light**	360°	5	1130 HA0 BLK
Red All-Round Light	360°	2	1130 RA0 BLK
Green All-Round Light	360°	2	1130 GA0 BLK
Yellow All-Round Light	360°	2	1130 MA0 BLK

\*These lights are supplied with a Gray Tinted Lens.  
 \*\*For Great Lakes use.



**FIG. 1127  
RED & GREEN SIDE LIGHTS  
112-1/2 DEGREES**



**FIG. 1128  
MASTHEAD LIGHT  
225 DEGREES**



**FIG. 1129  
STERN OR  
TOWING LIGHT  
135 DEGREES**



**FIG. 1130  
ALL-ROUND  
LIGHT  
360 DEGREES**

**IMPORTANT BULB DATA**

To comply with U.L. Standard 1104, the lights listed on this page must use a PERKO Cat. No. 374 bulb.

**SPARE PARTS ORDERING INFORMATION**

**Spare Lens Assemblies:**  
 Red, Cat. No. 249 000 RED.  
 Green, Cat. No. 249 000 GRN.  
 White, Cat. No. 249 000 CLR.  
 Gray, Cat. No. 249 000 GRY.  
 Yellow, Cat. No. 249 000 YLW.

Spare Double Contact Socket, Cat. No. 134.  
 Spare Access Cap, O-Ring and Retainer, Cat. No. 1105 000 BLK.  
 Spare O-Ring for Cap, Cat. No. 1119.

**Required Bulbs:**  
 12 Volts, Cat. No. 374 001 CLR.  
 24 Volts, Cat. No. 374 002 CLR.  
 32 Volts, Cat. No. 374 003 CLR.  
 120 Volts, Cat. No. 374 004 CLR.

NAVIGATION LIGHTS FOR VESSELS OVER 20 METERS



## NAVIGATION LIGHTS

**FIGS. 1150 - 1154 SERIES - CERTIFIED FOR USE ON VESSEL LENGTHS AS SPECIFIED BELOW.**

### CONSTRUCTION:

- \* SHEET METAL, GALVANIZED STEEL
- \* MEDIUM PREFOCUS SOCKET
- \* WATERTIGHT TERMINAL TUBE FOR 16/3-SO CABLE
- \* WATERTIGHT ACCESS CAP FOR REBULBING AND CLEANING
- \* 120 VOLT BULB NOT INCLUDED



Size No.	Height Overall Inches	Height Lens Inches	Weight Pounds
1	11-1/2	6-3/4	6-5/8
2	13-1/2	7-1/2	10-7/8

### ORDERING INFORMATION

**CERTIFIED FOR USE ON VESSELS  
20 METERS (65.6 FT.) TO 50 METERS (164.0 FT.) IN LENGTH.**

Description	Galvanized Steel*	Visibility Arc	Visibility Miles	Required Bulb
Red Side Light	1150 RE1 GAL	112-1/2°	2	342 002 CLR
Green Side Light	1150 GE1 GAL	112-1/2°	2	342 002 CLR
White Masthead Light	1151 E01 GAL	225°	5	342 003 CLR
White Stern Light	1152 E01 GAL	135°	2	342 000 CLR
Yellow Towing Light	1152 ME1 GAL	135°	2	342 000 CLR
White All-Round Light	1153 E01 GAL	360°	2	342 001 CLR
Red All-Round Light	1154 RE1 GAL	360°	2	342 004 CLR
Green All-Round Light	1154 GE1 GAL	360°	2	342 003 CLR
Yellow All-Round Light	1154 ME1 GAL	360°	2	342 002 CLR

**CERTIFIED FOR USE ON VESSELS OVER 20 METERS (65.6 FT.) IN LENGTH.**

Red Side Light	1150 RE2 GAL	112-1/2°	3	342 004 CLR
Green Side Light	1150 GE2 GAL	112-1/2°	3	342 004 CLR
White Masthead Light	1151 E02 GAL	225°	6	342 004 CLR
White Stern Light	1152 E02 GAL	135°	3	342 002 CLR
White All-Round Light	1153 E02 GAL	360°	3	342 003 CLR
Red All-Round Light	1154 RE2 GAL	360°	3	342 006 CLR
Green All-Round Light	1154 GE2 GAL	360°	3	342 004 CLR

\*Galvanized Steel Lights are Preprimed.



**FIG. 1150**



**FIG. 1151**



**FIG. 1152**



**FIG. 1153**



**FIG. 1154**

### IMPORTANT BULB DATA

To comply with U.L. Standard 1104, the lights listed on this page must use a PERKO Cat. No. 342 bulb.

### SPARE PARTS ORDERING INFORMATION

#### Spare Lenses:

112-1/2°	Cat. No. 259 No. 1 or 2, Specify Color.
135°	Cat. No. 269 No. 1 or 2, Specify Color.
225°	Cat. No. 256 No. 1 or 2, Specify Color.
360°	Cat. No. 261F No. 1 or 2, Specify Color.

Spare Medium Prefocus Socket, Cat. No. 347 A00.
Spare Access Cap, O-Ring and Retainer, Cat. No. 1105 000 BLK.
Spare O-Ring for Cap, Cat. No. 1119.
Spare Socket Supports, Cat. Nos. 341 001 PLB & 341 01A PLB.

## NAVIGATION LIGHTS

**FIGS. 4, 5 & 7 - CERTIFIED FOR USE ON VESSELS  
20 METERS (65.6 FT.) TO 50 METERS (164.0 FT.) IN LENGTH.**

### CONSTRUCTION:

- \* **SHEET METAL, GALVANIZED STEEL\*, POLISHED OR CHROME PLATED BRASS**
- \* **BOTTOM OPENING, COMPLETE WITH MOUNTING BRACKET**
- \* **SINGLE CONTACT PREFOCUS SOCKET FOR 12 VOLT USE ONLY**
- \* **12 VOLT BULB NOT INCLUDED**

Height Overall Inches	8-1/2	Height Lens Inches	5-3/16	Weight Pounds	3-1/8
-----------------------------	-------	--------------------------	--------	------------------	-------

### ORDERING INFORMATION

Description	Galvanized Steel	Polished Brass	Chrome Plated Brass	Visibility Arc	Visibility Miles	Required Bulb
Red Side Light	4 RD3 GAL	4 RD3 POL	4 RD3 CHR	112-1/2°	2	373 003 CLR
Green Side Light	4 GD3 GAL	4 GD3 POL	4 GD3 CHR	112-1/2°	2	373 002 CLR
White Masthead Light	5 D03 GAL	5 D03 POL	5 D03 CHR	225°	5	373 005 CLR
White Stern Light	7 D03 GAL	7 D03 POL	7 D03 CHR	135°	2	373 001 CLR
Yellow Towing Light	7 MD3 GAL	7 MD3 POL	7 MD3 CHR	135°	2	373 002 CLR

\*Galvanized Steel Lights are Preprimed.



**FIG. 4**



**FIG. 5**



**FIG. 7 & 7M**

### IMPORTANT BULB DATA

To comply with U.L. Standard 1104, the lights listed on this page must use a PERKO Cat. No. 373 bulb.

### SPARE PARTS ORDERING INFORMATION

#### Spare Lenses:

Red,	112-1/2°	Cat. No. 259 CL3 RED.
Green,	112-1/2°	Cat. No. 259 CL3 GRN.
White,	135°	Cat. No. 269 CL3 WHT.
Gray,	135°	Cat. No. 256 CL3 WHT.
Yellow,	225°	Cat. No. 269 CL3 YLW.

Spare Mounting Bracket; Cat. No. 131 000 GAL or PLB.  
Spare Single Contact Prefocus Socket Assembly, Complete with Stand, Bottom Plate and Gasket, Cat. No. 294 003 PLB.

## SPECIALTY ALL-ROUND LIGHTS

**FIGS. 403 & 412 - CERTIFIED FOR USE ON VESSELS  
OVER 20 METERS (65.6 FT.) IN LENGTH.**

**CONSTRUCTION:**

- \* **CAST BRONZE**
- \* **COMPLETE WITH MEDIUM PREFOCUS SOCKET**
- \* **120 VOLT BULB NOT INCLUDED**



Fig. No.	Height Overall Inches	Height Lens Inches	Tapped Pipe Size Inches	Weight Pounds	Visibility Miles
403	11-1/2	6-3/4	1	8-1/4	3
412	14	6-3/4	*	8-1/4	3



**Fig. 403-3**



**Fig. 412**

**ORDERING INFORMATION**

	White	Red	Green	Yellow
Fig. No. 403	403 E03 PLB**	403 RE3 PLB	403 GE3 PLB	403 ME3 PLB
Fig. No. 412	412 E00 PLB**	412 RE0 PLB	412 GE0 PLB	412 ME0 PLB

\*Supplied with watertight terminal tube for 16/3-SO cable.  
\*\*These Lights are Supplied with Gray Tinted Lenses.

**IMPORTANT BULB DATA**

To comply with U.L. Standard 1104, the lights listed on this page must use a PERKO Cat. No. 342 004 CLR bulb.

**SPARE PARTS ORDERING INFORMATION**

Spare Lenses:  
 Gray, Cat. No. 261 001 GRY.  
 Red, Cat. No. 261 001 RED.  
 Green, Cat. No. 261 001 GRN.  
 Yellow, Cat. No. 261 001 YLW.  
 Spare Lens or Cover Gasket, Cat. No. 1143.  
 Spare Medium Prefocus Socket, Cat. No. 347.

**FIG. 112 - CERTIFIED FOR USE ON VESSELS  
20 METERS (65.6 FT.) TO 50 METERS (164.0 FT.) IN LENGTH.**

**CONSTRUCTION:**

- \* **CAST BRONZE, PLAIN OR CHROME PLATED**
- \* **COMPLETE WITH DOUBLE CONTACT ELECTRICAL SOCKET**
- \* **12, 24, 32 OR 120 VOLTS. BULB NOT INCLUDED**



**Fig. 309A**

Fig. No.	Height Overall Inches	Diameter Base Inches	Tapped Pipe Size Inches	Weight Pounds	Visibility Miles
112	8-3/4	3-1/8	----	2-1/2	2
309	6-1/2	----	1/2	2-1/4	2



**Fig. 112A**

**ORDERING INFORMATION**

Description	Plain Bronze	Chrome Plated Bronze
White All-Round	112 A00 PLB	112 A00 CHR
Red All-Round	112 RA0 PLB	112 RA0 CHR
Green All-Round	112 GA0 PLB	112 GA0 CHR
Yellow All-Round	112 MA0 PLB	112 MA0 CHR

**ORDERING INFORMATION**

Description	Plain Bronze	Chrome Plated Bronze
White All-Round	309 A00 PLB	309 A00 CHR
Red All-Round	309 RA0 PLB	309 RA0 CHR
Green All-Round	309 GA0 PLB	309 GA0 CHR
Yellow All-Round	309 MA0 PLB	309 MA0 CHR

**IMPORTANT BULB DATA**

To comply with U.L. Standard 1104, the lights listed on this page must use a PERKO Cat. No. 374 bulb.

**SPARE PARTS ORDERING INFORMATION**

Spare Lenses:  
 Red, Cat. No. 106 000 RED.  
 Green, Cat. No. 106 000 GRN.  
 White, Cat. No. 106 000 WHT.  
 Yellow, Cat. No. 106 000 YLW.  
 Spare Double Contact Bayonet Socket, Cat. No. 276 002.  
Required Bulbs:  
 12 Volts, Cat. No. 374 001 CLR.  
 24 Volts, Cat. No. 374 002 CLR.  
 32 Volts, Cat. No. 374 003 CLR.  
 120 Volts, Cat. No. 374 004 CLR.



NAVIGATION LIGHTS FOR VESSELS OVER 20 METERS

## SPECIAL PURPOSE LIGHTS

**FIG. 1111ME - CERTIFIED FOR USE ON VESSELS OF ANY LENGTH.**

**CONSTRUCTION:**

- \* SHEET METAL, GALVANIZED STEEL\*
- \* COMPLETE WITH MEDIUM PREFOCUS SOCKET
- \* WATERTIGHT TERMINAL TUBE FOR 16/3-SO CABLE
- \* SEALED FLASHER UNIT
- \* WATERTIGHT ACCESS CAP FOR REBULBING AND CLEANING
- \* 120 VOLT BULB NOT INCLUDED

Designed to meet Federal Requirements for Flashing yellow 180° - 225° light for barges, canal boats, etc., that are being pushed ahead or towed along side of a tug boat. For use on 120 volts A.C. only. Federal Requirements for this light are applicable for: inland waters, the Atlantic, Pacific and Gulf coasts, intercoastal waterways and western rivers. Refer to the U.S. Inland Navigation Rules for application, configuration and technical details.



**Fig. 1111ME**

**ORDERING INFORMATION**

Galvanized Steel*	Height Overall Inches	Height Lens Inches	Visibility Miles	Visibility Arc	Flashes Per Minute	Weight Pounds
1111 ME1 GAL	11-1/2	6-3/4	2	225°	50-70	6-5/8

\*Galvanized Steel Lights are Preprimed.

**IMPORTANT BULB DATA**

To comply with Federal Requirements this light must use a PERKO Cat. No. 342 004 CLR bulb.

**SPARE PARTS ORDERING INFORMATION**

Spare Lenses:  
 Spare Flasher, Cat. No. 133. Spare Medium Prefocus Socket, Cat. No. 347 A00.  
 Spare O-Ring for Cap, Cat. No. 1119. Spare Access Cap, O-Ring and Retainer, Cat. No. 1105 000 BLK.  
 Spare Lens, Cat. No. 256 001 YLW.

**FIG. 1129BA - PANAMA CANAL BLUE STEERING LIGHT**

**CERTIFIED FOR USE ON VESSELS OF ANY LENGTH.**

**CONSTRUCTION:**

- \* BLACK PLASTIC
- \* PRE-WIRED DOUBLE CONTACT SOCKET WITH 3 FEET OF 16/3-SJO CABLE
- \* FOR 12, 24, 32 OR 120 VOLTS, BULB NOT INCLUDED



**Fig. 1129BA**

**ORDERING INFORMATION**

Cat. No.	Visibility Arc	Height Overall Inches	Height Lens Inches	Weight Pounds
1129 BAO BLK	135°	7-1/2	4-1/2	3-1/8

**IMPORTANT BULB DATA**

To comply with Panama Canal Requirements this light must use a PERKO Cat. No. 374 bulb.

**SPARE PARTS ORDERING INFORMATION**

Spare Lenses:  
 12 Volts, Cat. No. 374 001 CLR. Spare Lens, Cat. No. 249 000 BLU.  
 24 Volts, Cat. No. 374 002 CLR. Spare O-Ring for Cap, Cat. No. 1119.  
 32 Volts, Cat. No. 374 003 CLR. Spare Double Contact Socket, Cat. No. 134.  
 120 Volts, Cat. No. 374 004 CLR. Spare Plastic Cap, O-Ring and Retainer, Cat. No. 1105 000 BLK.

**FIG. 454E - ALL-ROUND WHITE WHISTLE LIGHT**

**CERTIFIED FOR USE ON VESSELS OVER 20 METERS (65.6 FT.) IN LENGTH.**



**CONSTRUCTION:**

- \* CAST BRONZE
- \* COMPLETE WITH MEDIUM PREFOCUS SOCKET
- \* 120 VOLT BULB NOT INCLUDED



**Fig. 454E**

**ORDERING INFORMATION**

Cat. No.	Height Overall Inches	Height Lens Inches	Tapped Pipe Size Inches	Weight Pounds	Visibility Miles
454 E00 PLB	11-1/2	6-3/4	1	8-1/4	5

**SPARE PARTS ORDERING INFORMATION**

Spare Lenses:  
 Spare Bulb, Cat. No. 342 004 CLR. Spare Lens or Cover Gasket, Cat. No. 1143.  
 Spare Lens, Cat. No. 261 001 CLR. Spare Medium Prefocus Socket, Cat. No. 347.

## SPARE PARTS

**FOR NAVIGATION LIGHTS ON VESSELS OVER 20 METERS (65.6 FT.) IN LENGTH.**

### DUAL MEDIUM PREFOCUS SOCKET ASSEMBLY



Phenolic - 250 Volts - 1000 Watts  
Plug In Type - Prewired - with two medium  
prefocus sockets. For use in double lens lights.

Cat. No.	Height Overall Inches	Width Overall Inches	Weight Ounces
303	3-7/8	3-7/8	9

Male Plug Only Cat. No. 303 A00.  
Female Socket Only Cat. No. 303 B00.

### SINGLE CONTACT PREFOCUS SOCKET ASSEMBLY - COMPLETE WITH STAND, BOTTOM PLATE AND GASKET



Cat. No.	Height Overall Inches	Diameter Overall Inches
294 003 PLB	3	3-3/4

### MEDIUM PREFOCUS SOCKETS



Phenolic - 250 Volts - 1000 Watts

Cat. No.	Height Overall Inches	Diameter Overall Inches	Standard Package	Weight Per Pkg. Ounces
347	1-7/8	1-1/2	5	21-1/2
347 A00	1-7/8	1-1/2	5	21-1/2

Cat. No. 347 A00 Supplied with metal Mounting Cap Tapped  
for 3/8 Inch I.P.S.

### 112-1/2° LENSES



	Height Overall Inches	Diameter Opening Inches	Catalog Number
Red	6-3/4	6-1/8	259 001 RED
Green	6-3/4	6-1/8	259 001 GRN
Red	7-1/2	9-1/4	259 002 RED
Green	7-1/2	9-1/4	259 002 GRN

Weight Size 1, 8.5 oz. - Weight Size 2, 19.5 oz.

### DOUBLE CONTACT SOCKET



Cat. No.	Height Overall Inches	Diameter Overall Inches
134	7/8	1-3/4

### 135° LENSES



	Height Overall Inches	Diameter Opening Inches	Catalog Number
White	6-3/4	5-1/8	269 001 WHT
Red	6-3/4	5-1/8	269 001 RED
Yellow	6-3/4	5-1/8	269 001 YLW
White	7-1/2	7-1/4	269 002 WHT
Red	7-1/2	7-1/4	269 002 RED

Weight Size 1, 14 oz. - Weight Size 2, 18.5 oz.

### DOUBLE CONTACT BAYONET BULBS

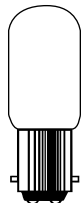

Clear - 12, 24, 32 or 120 Volts,  
Type T-8, C-8, Filament - 1-3/8 Inch L.C.L.

Cat. No.	Voltage	Wattage	Candella
374 001 CLR	12	30	24
374 002 CLR	24	30	24
374 003 CLR	32	30	24
374 004 CLR	120	30	24

Weight 1 oz. - Standard Pkg. - 1 pc.

### 225° LENSES



	Height Overall Inches	Diameter Opening Inches	Catalog Number
White	6-3/4	4-1/2	256 001 WHT
Yellow	6-3/4	4-1/2	256 001 YLW
White	7-1/2	6-5/8	256 002 WHT

Weight Size 1, 18.5 oz. - Weight Size 2, 27.5 oz.

### MEDIUM PREFOCUS BULBS

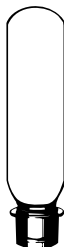

Cat. No.	Clear Volts	Wattage
342 000 CLR	120	7.5
342 001 CLR**	120	15
342 002 CLR**	120	25
342 003 CLR**	120	40
342 024 CLR	24	55
342 004 CLR**	120	60
342 RS4 CLR*	120	60
342 006 CLR	120	125
342 220 CLR	220	65

Weight 1 oz. - \*Designed for rough service.  
Standard Pkg. - 1 pc. - \*\*OEM - 25 pcs.

### 360° LENSES



	Height Overall Inches	Diameter Opening Inches	Clear Cat. No.	Frosted Cat. No.
White	6-3/4	5-1/8	261 001 CLR	261 001 FRD
Red	6-3/4	5-1/8	261 001 RED	261 RF1 FRD
Green	6-3/4	5-1/8	261 001 GRN	261 GF1 FRD
Yellow	6-3/4	5-1/8	261 001 YLW	261 MF1 FRD
Gray	6-3/4	5-1/8	261 001 GRY	-----
White	7-1/2	7-3/8	261 002 CLR	261 002 FRD
Red	7-1/2	7-3/8	261 002 RED	261 RF2 FRD
Green	7-1/2	7-3/8	261 002 GRN	261 GF2 FRD

Weight Size 1, 13.5 oz. - Weight Size 2, 43 oz.

### SINGLE CONTACT PREFOCUS BULBS



C-8 Filament Clear - 12 Volts

Cat. No.	Amperage	Mfg. No.
373 001 CLR	.25	25A/S8
373 002 CLR	.55	55A/S8
373 003 CLR	.77	77A/S8
373 004 CLR	1.15	1.15A/S8
373 005 CLR	2.03	2.03A/S8SCP

Weight 1 oz. - Standard Pkg. - 1 pc.

### 360° LENSES - With Top Assembly



	Height Overall Inches	Diameter Opening Inches	Catalog Number
White	5-3/4	5-1/2	249 000 CLR
Red	5-3/4	5-1/2	249 000 RED
Green	5-3/4	5-1/2	249 000 GRN
Yellow	5-3/4	5-1/2	249 000 YLW
Gray	5-3/4	5-1/2	249 000 GRY

Weight 17 oz.

NAVIGATION LIGHTS FOR VESSELS OVER 20 METERS

## SEARCHLIGHTS

### Figs. 534, 535 & 538 - SEARCHLIGHTS



FIG. 534

- CONSTRUCTION:**
- \* CHROME PLATED BRASS HEAD
  - \* FOR 12, 24 OR 32 VOLTS
  - \* TUNGSTEN OR HALOGEN
  - \* SWITCH IN HEAD

**FIG. 534 - DECK CONTROL.**

- \* CHROME PLATED BRONZE BASE
- \* 7 INCH SEALED BEAM BULB

**FIG. 535 - PILOT HOUSE CONTROL SEARCHLIGHT**

- \* CHROME PLATED BRONZE BASE
- \* 7 INCH SEALED BEAM BULB

- \* LEVER HANDLE CONTROLS BOTH HORIZONTAL AND VERTICAL MOVEMENT

- \* CONTROL LENGTH: 7-1/2 INCHES

- \* MAXIMUM CEILING THICKNESS: 4-1/2 INCHES

**FIG. 538 - DECK CONTROL**

- \* CHROME PLATED BRASS BASE
- \* 4-1/2 INCH SEALED BEAM BULB



FIG. 535



FIG. 538

### ORDERING INFORMATION

Voltage	O.D. Bulb Inches	Approx. Range Miles	Beam Candlepower	Wattage	Height Overall Inches	Base Dimension Inches	Catalog Number	Weight Pounds
12	7	5/8	250,000	100	12-1/2	4-7/8 x 3-1/8	534 003 12V	5
24	7	3/4	470,000	450	12-1/2	4-7/8 x 3-1/8	534 003 24V	5
32	7	5/8	260,000	200	12-1/2	4-7/8 x 3-1/8	534 003 32V	5
12	7	5/8	250,000	100	-----	4-7/8 x 3-1/8	535 003 12V	5
24	7	3/4	470,000	450	-----	4-7/8 x 3-1/8	535 003 24V	5
32	7	5/8	260,000	200	-----	4-7/8 x 3-1/8	535 003 32V	5
12	4-1/2	1/4	50,000	30	7-1/2	3-1/2 O.D.	538 000 CHR	1-1/2
12	4-1/2	1/3	100,000	50	7-1/2	3-1/2 O.D.	538 H00 CHR*	1-1/2

\*NOTE: "H" in the Catalog Number Designates a Halogen Bulb.

### FIG. 440 - REMOVABLE DECK CONTROL SEARCHLIGHT

**CONSTRUCTION:**

- \* CHROME PLATED BRASS HEAD, CHROME PLATED ZINC ALLOY BASE
- \* FOR 12 OR 32 VOLTS
- \* 4-1/2 OR 7 INCH SEALED BEAM BULB
- \* 8 FEET OF COILED CORD & CIGARETTE LIGHTER PLUG
- \* WATERTIGHT DECK CONNECTION. SWITCH IN HEAD



FIG. 440

### ORDERING INFORMATION

Voltage	O.D. Bulb Inches	Approx. Range Miles	Beam Candlepower	Wattage	Height Overall Inches	Catalog Number	Weight Pounds
12	4-1/2	1/4	50,000	30	7-1/2	440 001 12V	2-1/4
12	4-1/2	1/3	100,000	50	7-1/2	440 H01 12V*	2-1/4
12	7	5/8	250,000	100	10	440 003 12V	3-1/2
32	7	5/8	260,000	200	10	440 003 32V	3-1/2

Base Diameter, 2-1/8 Inches.

\*NOTE: "H" in the Catalog Number Designates a Halogen Bulb.

### SPARE SEALED BEAM ORDERING INFORMATION

Spare 4-1/2 Inch Sealed Beam Unit, Cat. No. 433 001 12V.  
Spare 4-1/2 Inch Halogen Sealed Beam Unit, Cat. No. 435 001 12V.

Spare 7 Inch Sealed Beam Unit (12 Volt), Cat. No. 433 003 12V.  
Spare 7 Inch Sealed Beam Unit (24 Volt), Cat. No. 433 003 24V.  
Spare 7 Inch Sealed Beam Unit (32 Volt), Cat. No. 433 003 32V.

## SEARCHLIGHTS

**FIG. 314 - PILOT HOUSE CONTROL SEARCHLIGHT**

**CONSTRUCTION:**

- \* **CHROME PLATED BRASS HEAD WITH CHROME PLATED BRONZE BASE**
- \* **CORROSION RESISTANT, SPLASH PROOF CONSTRUCTION**
- \* **7 & 8 INCH SEALED BEAM UNITS**
- \* **TIN PLATED ELECTRICAL CONTACTS AND WIRING**
- \* **LEVER ACTION, PILOT HOUSE CONTROL**
- \* **380° HORIZONTAL MOVEMENT, 70° VERTICAL MOVEMENT**
- \* **LEVER HANDLE CONTROLS BOTH HORIZONTAL AND VERTICAL MOVEMENT**
- \* **FOR CEILING THICKNESSES OF UP TO 5"**

**NEW**  
H.I.D. VERSION

**FIG. 314 STANDARD**

- \* **FOR 12, 24 OR 32 VOLTS**

**FIG. 314 H.I.D.**

- \* **HIGH INTENSITY DISCHARGE TECHNOLOGY**
- \* **FOR 12 VOLT SYSTEMS ONLY**
- \* **GREATER INTENSITY AND BEAM UNIFORMITY THAN CONVENTIONAL SEALED BEAM SEARCHLIGHTS**
- \* **FIVE TIMES THE TARGET RESOLVING POWER THAN CONVENTIONAL SEALED BEAMS**
- \* **LOW POWER CONSUMPTION, APPROXIMATELY 4 AMPS AT 12 VOLTS**
- \* **FIVE YEAR LAMP WARRANTY**



**Fig. 314**

**ORDERING INFORMATION**

Overall Length	Voltage	Approx. Range Miles	Beam Candlepower	Wattage	Catalog Number
<b>7 Inch Head</b>					
<b>Standard</b>					
24	12	5/8	250,000	100	314 C07 12V
24	24	3/4	470,000	450	314 C07 24V
24	32	5/8	260,000	200	314 C07 32V
<b>H.I.D.</b>					
24	12	1	-----	35	314 CH7 12V
<b>8 Inch Head</b>					
<b>Standard</b>					
26	12	3/4	500,000	250	314 C08 12V
26	24	3/4	500,000	600	314 C08 24V
26	32	3/4	500,000	600	314 C08 32V

**Sealed Beam Information**

Replacement Sealed Beam Unit For 7 Inch Head, 12 Volt, Cat. No. 433 003 12V  
 Replacement Sealed Beam Unit For 7 Inch Head, 24 Volt, Cat. No. 433 003 24V  
 Replacement Sealed Beam Unit For 7 Inch Head, 32 Volt, Cat. No. 433 003 32V

Replacement Sealed Beam Unit For 8 Inch Head, 12 Volt, Cat. No. 433 004 12V  
 Replacement Sealed Beam Unit For 8 Inch Head, 24 Volt, Cat. No. 433 004 24V  
 Replacement Sealed Beam Unit For 8 Inch Head, 32 Volt, Cat. No. 433 004 32V\*

\*Used in conjunction with Internal Dropping Resistor (Cat. No. 314 R32 99A).

## SOLAR-RAY® SEALED BEAM SEARCHLIGHTS

**BRONZE BASE, BRASS BODY**  
**POLISHED CHROME PLATED OR WHITE PERKO•KOTE POWDER COATING**  
**FOR 12, 24 OR 32 VOLTS**

### DIMENSIONS (INCHES)

"A"	"B"	"C"	"D"	"G"	"H"
8	8-1/2	10	7	2	2-1/8

### ELECTRICAL SPECIFICATIONS

Voltage	Wattage	Approximate Candlepower	Sealed Beam Range Miles	Spare Bulb Catalog No.
12	100	250,000	5/8	433 003 12V
24	450	470,000	3/4	433 003 24V
32	200	260,000	5/8	433 003 32V

### FIGS. 305 & 313 - SEARCHLIGHT HEADS



**FIG. 313**

### ORDERING INFORMATION

Voltage	Head Only Polished Chrome For Lever Control Cat. No.	Head Only White PERKO•KOTE For Lever Control Cat. No.	Head Only Polished Chrome For Wheel or Lever/Gear Control Cat. No.	Head Only White PERKO•KOTE For Wheel or Lever/Gear Control Cat. No.
12	305 H12 CHR	305 H12 WHT	313 H12 CHR	313 H12 WHT
24	305 H24 CHR	305 H24 WHT	313 H24 CHR	313 H24 WHT
32	305 H32 CHR	305 H32 WHT	313 H32 CHR	313 H32 WHT

Nominal Weight - 20 lbs.

Fig. 354 Spare Front Bezel with Glass for Figs. 305 & 313, Specify Chrome or White.  
 Fig. 355 Spare Rear Cover for Figs. 305 & 313, Specify Chrome or White.

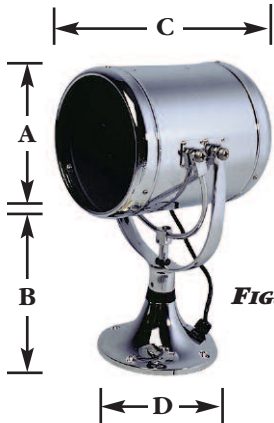

**FIG. 305**

### FIGS. 851, 852 & 969 - CONTROL ASSEMBLIES

#### STAINLESS STEEL TUBES WITH CHROME PLATED FITTINGS

Control Assemblies of Different Types May Be Interchanged to Offer a Large Variety of Searchlights With a Minimum of Inventory.

Note: Lever Control (Fig. 851) Fits Fig. 305 Head Assemblies.  
 Wheel Control (Fig. 852) and Lever/Gear Control (Fig. 969) Fits Fig. 313 Head Assemblies.

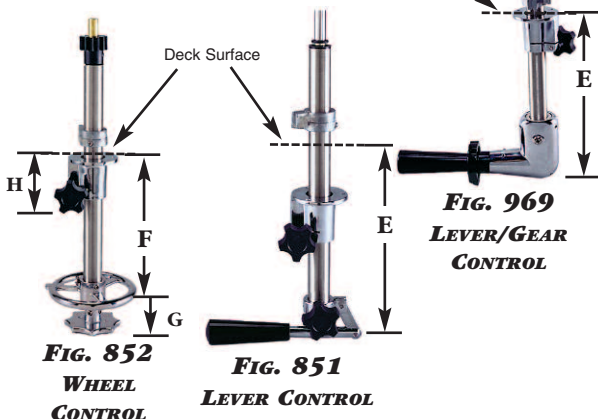

**FIG. 852**  
WHEEL CONTROL

**FIG. 851**  
LEVER CONTROL

**FIG. 969**  
LEVER/GEAR CONTROL

### ORDERING INFORMATION

Control Length Inches	"E" "F"	"E" Lever Control Cat. No.	"E" Lever/Gear Control Cat. No.	"F" Wheel Control Cat. No.	Nominal Weight Pounds
8-1/2	7-1/2	851 000*	969 000**	852 000***	6
15-1/2	14-1/2	851 0A0	969 0A0	852 0A0	9
22-1/2	21-1/2	851 0B0	969 0B0	852 0B0	12
29-1/2	28-1/2	851 0C0	969 0C0	852 0C0	15

\*Maximum Ceiling Thickness, 4-1/2 Inches.  
 \*\*Maximum Ceiling Thickness, 3-1/2 Inches.  
 \*\*\*Maximum Ceiling Thickness, 3 Inches.



## SOLAR-RAY® SEARCHLIGHTS

### 800 SERIES

10", 12" OR 14"

**CAST BRONZE AND HEAVY GAUGE BRASS  
POLISHED CHROME OR WHITE PERKO•KOTE FINISH  
12, 24, 32, 120 OR 230 VOLTS**

The 800 Series - Solar-Ray® Searchlights are available in 10", 12" and 14" sizes with your choice of Deck, Wheel, or Lever/Gear Controls. All models feature: halo deflectors, parabolic glass mirror reflectors for maximum light output and ventilation covers for quick dissipation of heat to help prolong bulb life. Hinged front doors have quick release stainless steel latches to provide easy access for bulb replacement. The 800 Series models are also available in our white PERKO•KOTE finish, an advanced powder coating process that eliminates the need for painting while providing a scratch resistant and chip-proof surface for painting when necessary to match the color of the vessel.

**Bulbs are not included and must be ordered separately.** PERKO offers a choice of the traditional incandescent or the brighter, more piercing quartz-halogen bulbs in a broad variety of voltages and wattages to fit every need. For complete information on bulbs and candlepower output, see page 65.

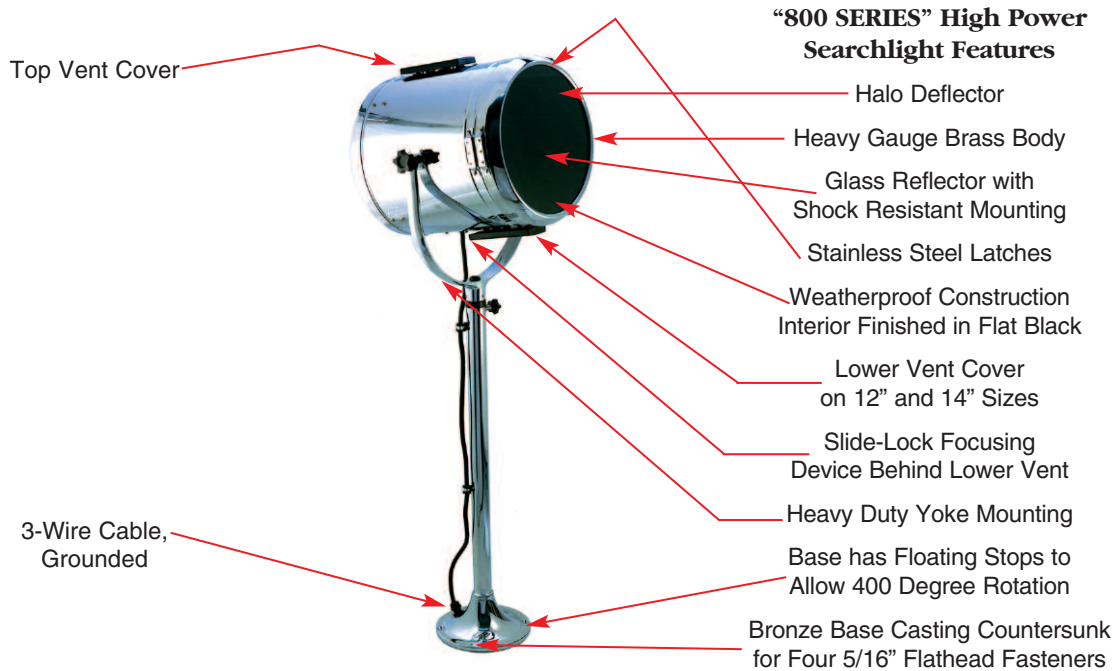

### CONTROL TYPES



#### DECK CONTROL

Equipped with handles on the rear cover for positioning.

#### LEVER CONTROL

Aim handle for horizontal position. Move handle up and down for vertical position.

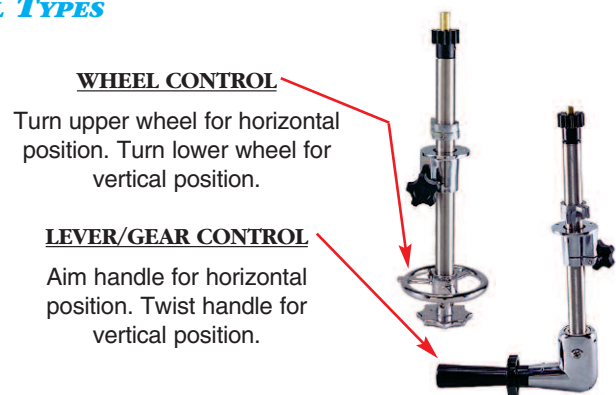

#### WHEEL CONTROL

Turn upper wheel for horizontal position. Turn lower wheel for vertical position.

#### LEVER/GEAR CONTROL

Aim handle for horizontal position. Twist handle for vertical position.

## DECK CONTROL SOLAR-RAY® SEARCHLIGHTS

### 883 SERIES

10", 12" OR 14"

#### SEARCHLIGHT DIMENSIONS

"A" Nominal Drum Diameter Inches	"C" Length Drum Inches	Nominal Weight Pounds
10	13	28
12	15	38
14	17	45



**FIG. 883 - STANDARD PEDESTAL**



**FIG. 883 - MEDIUM PEDESTAL**



**FIG. 883 - HIGH PEDESTAL**

\* Note: The "J" Dimension is Height Overall.

## DECK CONTROL SOLAR-RAY® SEARCHLIGHTS

### 883 SERIES

10", 12" OR 14"

#### ORDERING INFORMATION

- NOTES: 1) These Searchlights Cannot Be Fitted With Controls.  
 2) Bulbs Must be Ordered Separately, Refer to Pages 64 and 65 for Ordering Information.  
 3) Refer to Worksheet on Page 66 For Help in Ordering.

#### STANDARD PEDESTAL SEARCHLIGHTS

Nominal Reflector Size Inches	"J" Height Overall Inches	Polished Chrome Catalog No.	White PERKO•KOTE Catalog No.
10	20-1/8	883 0P1 CHR	883 0P1 WHT
12	22-1/8	883 0P2 CHR	883 0P2 WHT
14	25-1/8	883 0P3 CHR	883 0P3 WHT

Standard Pedestal Base Diameter, 7 Inches.

#### MEDIUM PEDESTAL SEARCHLIGHTS

Nominal Reflector Size Inches	"J" Height Overall Inches	Polished Chrome Catalog No.	White PERKO•KOTE Catalog No.
10	27-1/2	883 MP1 CHR	883 MP1 WHT
12	29-1/2	883 MP2 CHR	883 MP2 WHT
14	32-1/2	883 MP3 CHR	883 MP3 WHT

Medium Pedestal Base Diameter, 8 Inches.

#### HIGH PEDESTAL SEARCHLIGHTS

Nominal Reflector Size Inches	"J" Height Overall Inches	Polished Chrome Catalog No.	White PERKO•KOTE Catalog No.
10	44	883 HP1 CHR	883 HP1 WHT
12	46	883 HP2 CHR	883 HP2 WHT
14	49	883 HP3 CHR	883 HP3 WHT

High Pedestal Base Diameter, 8 Inches.

**NOTE: Custom Pedestal Heights are Available.  
 Price Upon Application.  
 Specify the "J" Dimension for Custom Pedestal Height.**

## LEVER CONTROL SOLAR-RAY® SEARCHLIGHTS

### 884 SERIES

10", 12" AND 14"

#### SEARCHLIGHT DIMENSIONS

"A" Nominal Drum Diameter Inches	"C" Length Drum Inches	Nominal Weight Pounds
10	13	28
12	15	38
14	17	45

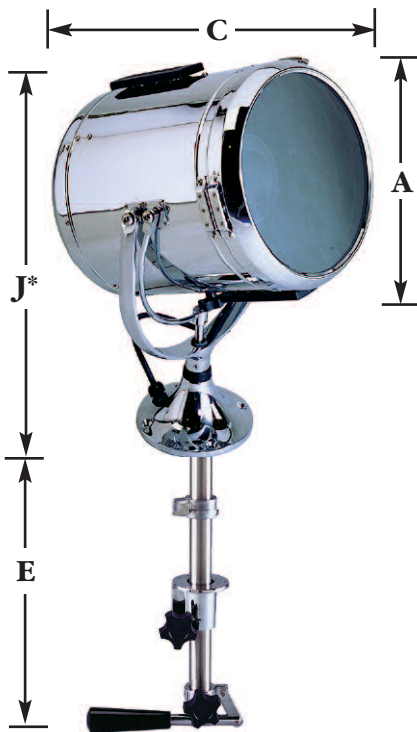

**FIG. 884**  
**STANDARD PEDESTAL**



**FIG. 884**  
**MEDIUM PEDESTAL**

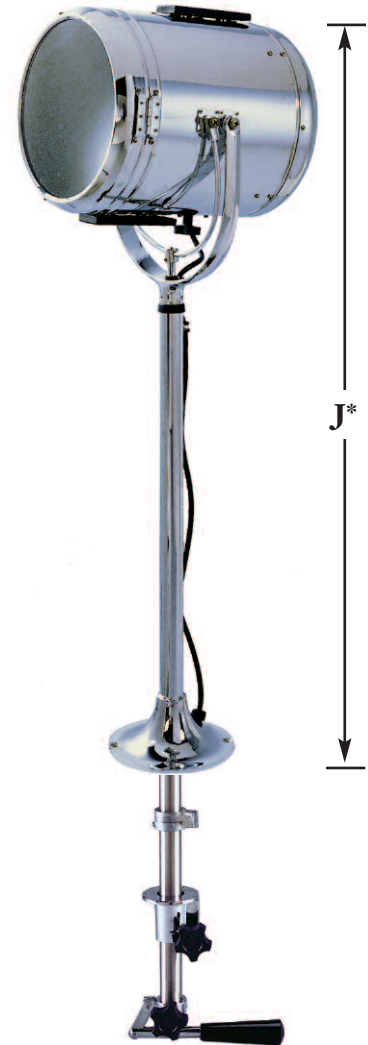

**FIG. 884**  
**HIGH PEDESTAL**

\* Note: The "J" Dimension is height from mounting surface to the top of the light.

## LEVER CONTROL SOLAR-RAY® SEARCHLIGHT HEAD ASSEMBLIES

### 884 SERIES

10", 12" AND 14"

#### ORDERING INFORMATION

- NOTES: 1) Bulbs Must be Ordered Separately, Refer to Pages 64 and 65 for Ordering Information.  
2) Refer to Worksheet on Page 66 For Help in Ordering.

#### STANDARD PEDESTAL SEARCHLIGHT HEAD ASSEMBLIES

Nominal Reflector Size Inches	"J" Height Inches	Polished Chrome Catalog No.	White PERKO•KOTE Catalog No.
10	20-1/8	884 0P1 CHR	884 0P1 WHT
12	22-1/8	884 0P2 CHR	884 0P2 WHT
14	25-1/8	884 0P3 CHR	884 0P3 WHT

Standard Pedestal Base Diameter, 7 Inches.

#### MEDIUM PEDESTAL SEARCHLIGHT HEAD ASSEMBLIES

Nominal Reflector Size Inches	"J" Height Inches	Polished Chrome Catalog No.	White PERKO•KOTE Catalog No.
10	28-1/4	884 MP1 CHR	884 MP1 WHT
12	30-1/4	884 MP2 CHR	884 MP2 WHT
14	33-1/4	884 MP3 CHR	884 MP3 WHT

Medium Pedestal Base Diameter, 8 Inches.

#### HIGH PEDESTAL SEARCHLIGHT HEAD ASSEMBLIES

Nominal Reflector Size Inches	"J" Height Inches	Polished Chrome Catalog No.	White PERKO•KOTE Catalog No.
10	44-3/4	884 HP1 CHR	884 HP1 WHT
12	46-3/4	884 HP2 CHR	884 HP2 WHT
14	49-3/4	884 HP3 CHR	884 HP3 WHT

High Pedestal Base Diameter, 8 Inches.

**NOTE: Custom Pedestal Heights are Available. Price Upon Application. Specify the "J" Dimension for Custom Pedestal Height.**

#### FIG. 851 - LEVER CONTROL ASSEMBLIES

Control assemblies of different lengths may be interchanged on Solar-Ray® searchlights (Fig. 884) of the same pedestal height. The following chart makes it possible to order and stock different styles of these assemblies separately to offer a large variety of Solar-Ray® searchlights with a minimum of inventory.

#### ORDERING INFORMATION

"E" Length Control Inches	For Standard Pedestal Cat. No.	For Medium Pedestal Cat. No.	For High Pedestal Cat. No.	Nominal Weight Pounds
8-1/2	851 000*	851 M00*	851 H00*	6
15-1/2	851 0A0	851 MA0	851 HA0	9
22-1/2	851 0B0	851 MB0	851 HB0	12
29-1/2	851 0C0	851 MC0	851 HC0	15

\* Maximum Ceiling Thickness, 4-1/2 Inches.

**NOTE: Custom Control Lengths are Available. Price Upon Application. Specify the "E" Dimension for Custom Control Lengths.**

## WHEEL OR LEVER/GEAR CONTROL SOLAR-RAY® SEARCHLIGHTS

### 885 SERIES

10", 12" AND 14"

#### SEARCHLIGHT DIMENSIONS

"A" Nominal Drum Diameter Inches	"C" Length Drum Inches	Nominal Weight Pounds
10	13	28
12	15	38
14	17	45

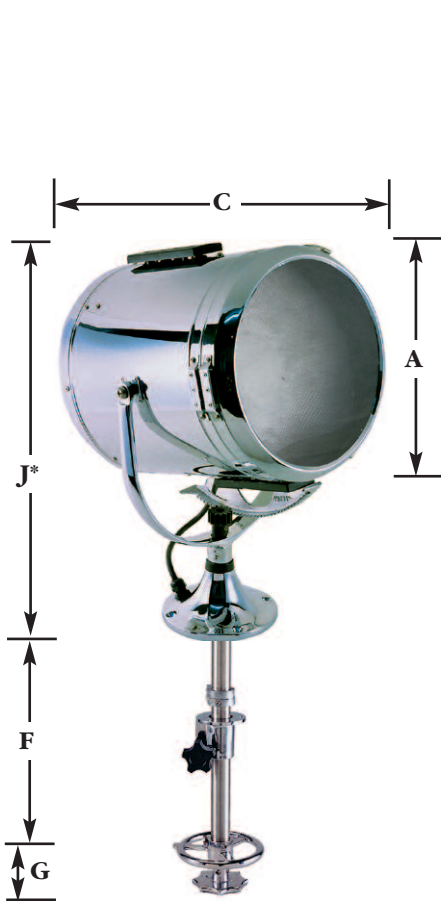

**FIG. 885**  
**STANDARD PEDESTAL**  
**SHOWN WITH WHEEL CONTROL**



**FIG. 885**  
**MEDIUM PEDESTAL**  
**SHOWN WITH**  
**LEVER/GEAR CONTROL**

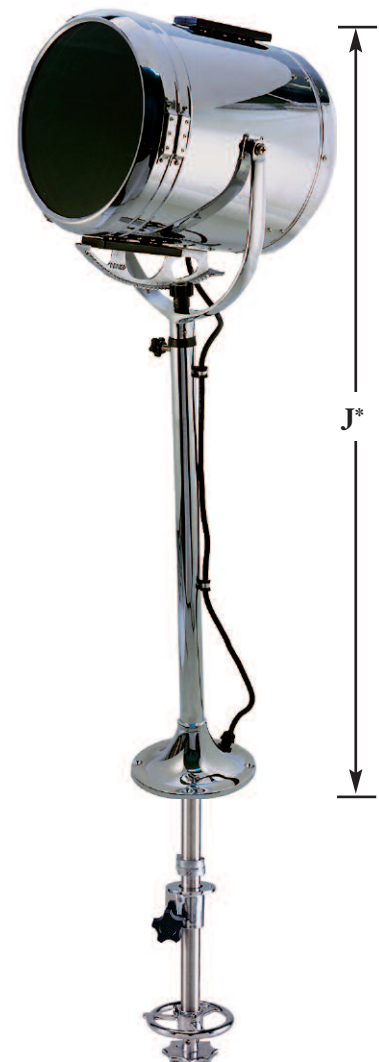

**FIG. 885**  
**HIGH PEDESTAL**  
**SHOWN WITH WHEEL CONTROL**

\* Note: The "J" Dimension is height from mounting surface to the top of the light.

## WHEEL OR LEVER/GEAR CONTROL SOLAR-RAY® SEARCHLIGHTS HEAD ASSEMBLIES

### 885 SERIES

10", 12" AND 14"

#### ORDERING INFORMATION

- Notes: 1) Bulbs Must be Ordered Separately, Refer to Pages 64 and 65 for Ordering Information.  
 2) Refer to Worksheet on Page 66 For Help in Ordering.

#### STANDARD PEDESTAL SEARCHLIGHT HEAD ASSEMBLIES

Nominal Reflector Size Inches	"J" Height Overall Inches	Polished Chrome Catalog No.	White PERKO•KOTE Catalog No.
10	20-1/8	885 0P1 CHR	885 0P1 WHT
12	22-1/8	885 0P2 CHR	885 0P2 WHT
14	25-1/8	885 0P3 CHR	885 0P3 WHT

Standard Pedestal Base Diameter, 7 Inches.

#### MEDIUM PEDESTAL SEARCHLIGHT HEAD ASSEMBLIES

Nominal Reflector Size Inches	"J" Height Overall Inches	Polished Chrome Catalog No.	White PERKO•KOTE Catalog No.
10	28-1/4	885 MP1 CHR	885 MP1 WHT
12	30-1/4	885 MP2 CHR	885 MP2 WHT
14	33-1/4	885 MP3 CHR	885 MP3 WHT

Medium Pedestal Base Diameter, 8 Inches.

#### HIGH PEDESTAL SEARCHLIGHT HEAD ASSEMBLIES

Nominal Reflector Size Inches	"J" Height Overall Inches	Polished Chrome Catalog No.	White PERKO•KOTE Catalog No.
10	44-3/4	885 HP1 CHR	885 HP1 WHT
12	46-3/4	885 HP2 CHR	885 HP2 WHT
14	49-3/4	885 HP3 CHR	885 HP3 WHT

High Pedestal Base Diameter, 8 Inches.

**NOTE: Custom Pedestal Heights are Available. Price Upon Application. Specify the "J" Dimension for Custom Pedestal Height.**

#### CONTROL ASSEMBLIES - FIGS. 852 & 969

Control Assemblies of different lengths may be interchanged on Solar-Ray® searchlights (Fig. 885) of the same pedestal height. The following chart makes it possible to order and stock different styles of these assemblies separately to offer a large variety of Solar-Ray® Searchlights with a minimum of inventory.

#### WHEEL CONTROL - FIG. 852

##### ORDERING INFORMATION

"F" Length Control Inches	For Standard Pedestal Cat. No.	For Medium Pedestal Cat. No.	For High Pedestal Cat. No.	Nominal Weight Pounds
7-1/2	852 000*	852 M00*	852 H00*	6
14-1/2	852 0A0	852 MA0	852 HA0	9
21-1/2	852 0B0	852 MB0	852 HB0	12
28-1/2	852 0C0	852 MC0	852 HC0	15

"G" Distance Between Wheels, 2 Inches.

\*Maximum Ceiling Thickness, 3 Inches.

#### LEVER/GEAR CONTROL - FIG. 969

##### ORDERING INFORMATION

"E" Length Control Inches	For Standard Pedestal Cat. No.	For Medium Pedestal Cat. No.	For High Pedestal Cat. No.	Nominal Weight Pounds
8-1/2	969 000*	969 M00*	969 H00*	6
15-1/2	969 0A0	969 MA0	969 HA0	9
22-1/2	969 0B0	969 MB0	969 HB0	12
29-1/2	969 0C0	969 MC0	969 HC0	15

\*Maximum Ceiling Thickness, 3-1/2 Inches.

**NOTE: Custom Control Lengths are Available. Price Upon Application. Specify the "E" or "F" Dimension for Custom Control Lengths.**

## BULB AND SOCKET ORDERING INFORMATION FOR SOLAR-RAY® SEARCHLIGHTS

### 800 SERIES - 10", 12" AND 14"

**BULBS ARE NOT INCLUDED IN LIGHTS**

To give good results, the bulb and reflector must be perfectly compatible; therefore be sure to specify the catalog number of the bulb desired. Peak candlepower is exceedingly sensitive to many factors, (i.e., a light source out of focus by 1/32 inch, under-voltage of only 4%, or differences between bulb manufacturers) which can cause a reduction of range of up to 20%.

#### INCANDESCENT BULB ORDERING INFORMATION

Bulb Catalog Number	Voltage	Wattage	Socket Type	Socket Code Letter	For Searchlight Sizes Inches	Rated* Life Hours	Mfg. Bulb Code
806	32	500	Medium Screw	B	10, 12, 14	50	DLT
807	120	500	Medium Prefocus	E	10, 12, 14	25	CZX
809	120	750	Medium Prefocus	E	12, 14	25	DDB
837	120	750	Medium Prefocus	E	12, 14	200	DGH
810	120	1000	Medium Prefocus	E	12, 14	25	DRS
811	120	1000	Mogul Screw	D	12, 14	50	DPT

For a More Concentrated Beam, Longer Range, Brighter Light and a Longer Life, We Recommend the Following Bulbs:

#### "QUARTZ" TUNGSTEN-HALOGEN BULB ORDERING INFORMATION

Bulb Catalog Number	Voltage	Wattage	Socket Type	Socket Code Letter	For Searchlight Sizes Inches	Rated* Life Hours	Mfg. Bulb Code
816	12	100	2-Pin Prefocus	F	10, 12, 14	50	FDT
836	24	150	2-Pin Prefocus	G	10, 12, 14	50	DZE-FDS
817	32	200	2-Pin Prefocus	H	10, 12, 14	200	G.E. 1945
844	120	500	Medium Prefocus	E	10, 12, 14	500	BTL
820	120	600	2-Pin Prefocus	I	10, 12, 14	75	DYS
845	120	750	Medium Prefocus	E	12, 14	200	BTP
839	120	900	2-Pin Prefocus	K	12, 14	75	BVA
846	120	1000	Medium Prefocus	E	12, 14	200	BTR
860	230	1000	Medium Prefocus	E	12, 14	950	FKD

**PLEASE ORDER CAREFULLY, BULBS ARE NOT RETURNABLE.**

**\*NOTE:** These are the "Rated Average Laboratory Life in Hours" of the Bulb Manufacturer obtained in closely controlled laboratory life testing groups of lamps at their design voltage. It is not necessarily the same as the service life where conditions such as shock, vibration, voltage fluctuation and environment may result in a shorter average attained life.

#### ELECTRIC SOCKET AND SUPPORT STAND ASSEMBLIES

Solar-Ray® Searchlights include a socket and support stand assembly based on the bulb or socket information given when ordering. The following chart makes it possible to order and stock different socket and stand assemblies for field conversion to meet a large variety of voltage and candlepower requirements with a minimum of inventory.

#### ORDERING INFORMATION

Socket Type	Socket Code	For 10" Searchlights		For 12" Searchlights		For 14" Searchlights	
		Catalog Number	Height Stand Inches	Catalog Number	Height Stand Inches	Catalog Number	Height Stand Inches
Medium Screw	B	872 001	1-1/4	872 002	2-1/4	872 003	3-1/4
Medium Prefocus	E	873 001	1-5/16	873 002	1-15/16	873 003	2-15/16
Mogul Screw	D	-----	-----	874 002	7/16	874 003	1-1/4
2-Pin Prefocus (12 Volt)	F	875 001	3-1/2	875 002	4-1/2	875 003	5-1/2
2-Pin Prefocus (24 Volt)	G	876 001	3-1/4	876 002	4-1/4	876 003	5-1/4
2-Pin Prefocus (32 Volt)	H	878 001	3-1/4	878 002	4-1/4	878 003	5-1/4
2-Pin Prefocus (600 Watt)	I	879 001	3-1/8	879 002	4-1/8	879 003	5-1/8
2-Pin Prefocus (900 Watt)	K	-----	-----	880 002	3-13/16	880 003	4-13/16

**NOTE: Refer to Page 70 for Spare/Replacement Electric Socket Only Ordering Information.**



## BULB TECHNICAL DATA FOR SOLAR-RAY® SEARCHLIGHTS

### 800 SERIES

**THE FOLLOWING CHART IS PROVIDED TO AID IN PROPER BULB SELECTION:**

Searchlight Size Inches	Voltage	Approximate Range Miles*	Bulb Catalog Number	Bulb Wattage	Rated Life Hours**	Maximum Candlepower Output	Horizontal Beam Spread Degrees	Vertical Beam Spread Degrees
10"	12	1	816	100	50	1,168,000	1.7	1.4
	24	1	836	150	50	891,000	2.6	1.5
	32	3/4	817	200	200	571,000	2.6	1.7
	32	1	806	500	50	943,000	3.4	3.9
	120	1	820	600	75	908,000	4.4	2.2
	120	1-1/8	807	500	25	1,332,000	3.5	2.8
	120	1-1/8	844	500	500	1,260,000	3.1	3.4
12"	12	1-1/4	816	100	50	1,617,000	1.5	1.2
	24	1-1/8	836	150	50	1,349,000	2.2	1.5
	32	7/8	817	200	200	865,000	2.4	1.6
	32	1-1/8	806	500	50	1,496,000	3.4	3.5
	120	1	837	750	200	977,000	4.1	3.7
	120	1	845	750	200	1,185,000	3.7	5.2
	120	1-1/8	820	600	75	1,410,000	4.3	1.9
	120	1-1/4	809	750	25	1,792,000	3.6	3.4
	120	1-1/4	844	500	500	1,641,000	3.2	3.4
	120	1-1/4	807	500	25	1,799,000	3.3	3.1
	120	1-1/4	811	1000	50	1,816,000	4.0	4.9
	120	1-3/8	810	1000	25	1,894,000	4.0	3.8
	120	1-3/8	846	1000	200	1,911,000	3.9	5.0
	120	1-1/2	839	900	75	2,482,000	4.5	5.5
	230	7/8	860	1000	950	865,000	6.9	5.9
14"	12	1-1/4	816	100	50	1,756,000	1.5	1.0
	24	1-1/8	836	150	50	1,367,000	2.3	1.2
	32	1	817	200	200	943,000	2.2	1.5
	32	1-1/8	806	500	50	1,591,000	4.0	3.7
	120	1-1/8	837	750	200	1,254,000	3.9	4.5
	120	1-1/8	845	750	200	1,531,000	3.6	5.1
	120	1-1/4	820	600	75	1,626,000	4.5	1.9
	120	1-3/8	844	500	500	1,840,000	2.9	3.2
	120	1-3/8	811	1000	50	2,249,000	4.0	5.1
	120	1-1/2	807	500	25	2,353,000	3.2	3.2
	120	1-1/2	809	750	25	2,422,000	3.7	4.0
	120	1-1/2	846	1000	200	2,586,000	3.8	5.0
	120	1-1/2	810	1000	25	2,621,000	4.0	4.5
	120	1-5/8	839	900	75	2,889,000	4.5	5.2
	230	1	860	1000	950	1,021,000	7.7	6.2

\*The approximate ranges listed above are based on photometric measurements of beam candlepower output under ideal conditions. Many factors such as atmospheric conditions, size and color of target, background, etc., may reduce effective range considerably; therefore, these figures are offered only as a guide to compare different bulb and voltage options.

**\*\*NOTE:** These are the "Rated Average Laboratory Life in Hours" of the Bulb Manufacturer obtained in closely controlled laboratory life testing of groups of lamps at their design voltage. It is not necessarily the same as the service life where conditions such as shock, vibration, voltage fluctuation and environment may result in a shorter average attained life.



**2-PIN PREFOCUS**



**MOGUL SCREW**



**MEDIUM PREFOCUS**



**MEDIUM SCREW**

## SOLAR-RAY® SEARCHLIGHT ORDERING WORKSHEET

### 800 SERIES

- 1) **Head Assembly Type:** \_\_\_\_\_ }
  - a) For deck control - 883
  - b) For lever control - 884
  - c) For wheel and lever/gear control - 885
- 2) **Pedestal (overall) Height (see catalog page for details):** \_\_\_\_\_ }
  - a) Standard - O
  - b) Medium - M
  - c) High - H

*For custom pedestal height see no. 10 below.*
- 3) **Reflector Size:** \_\_\_\_\_ }
  - a) 10 inch - 1
  - b) 12 inch - 2
  - c) 14 inch - 3
- 4) **Finish:** \_\_\_\_\_ }
  - a) PERKOPLATE (polished chrome) - CHR
  - b) PERKO•KOTE (white) - WHT
- 5) **Control Type:** \_\_\_\_\_ }
  - a) Lever control (For 884 Head Assembly) - 851
  - b) Wheel control (For 885 Head Assembly) - 852
  - c) Lever/Gear control (For 885 Head Assembly) - 969
- 6) **Control Length (when necessary):** \_\_\_\_\_ }
  - a) (8-1/2" for 851 & 969) or (7-1/2" for 852) - 0
  - b) (15-1/2" for 851 & 969) or (14-1/2" for 852) - A
  - c) (22-1/2" for 851 & 969) or (21-1/2" for 852) - B
  - d) (29-1/2" for 851 & 969) or (28-1/2" for 852) - C
- 7) **Bulb Number (see pages 64 & 65 for details):** \_\_\_\_\_ }
  - a) \_\_\_\_\_
- 8) **Socket Type:** .....Code: \_\_\_\_\_ }
  - a) Medium Screw ..... "B"
  - b) Medium Prefocus ..... "E"
  - c) Mogul Screw ..... "D" (Not for use with 10 inch reflector.)
  - d) 2-Pin Prefocus (12 volt) ..... "F"
  - e) 2-Pin Prefocus (24 volt) ..... "G"
  - f) 2-Pin Prefocus (32 volt) ..... "H"
  - g) 2-Pin Prefocus (600 Watt) ..... "I"
  - h) 2-Pin Prefocus (900 watt) ..... "K" (Not for use with 10 inch reflector.)
- 9) **Custom control length:** \_\_\_\_\_  
Specify control length desired as measured from pedestal base to lower end of control assembly ("E" or "F" dimension).
- 10) **Custom pedestal height:** \_\_\_\_\_  
Specify overall height of searchlight desired as measured from the top of the searchlight head to the bottom of the pedestal base ("J" dimension).

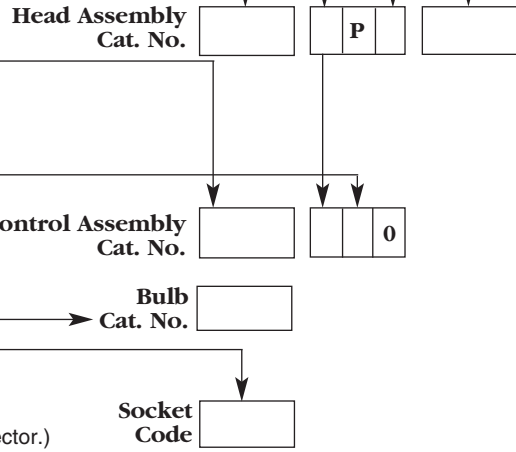

SPARE PARTS FOR 800 SERIES SOLAR-RAY® SEARCHLIGHTS						
Fig.	Size	Front Glass Cat. No.	Front Door with Glass Cat. No.	Rear Cover Cat. No.	Reflector* Cat. No.	Pinion Gear Cat. No.
883	10"	889 001 CLR	891 001 CHR	908 001 CHR	890 001	----
	12"	889 002 CLR	891 002 CHR	908 002 CHR	890 002	----
	14"	889 003 CLR	891 003 CHR	908 003 CHR	890 003	----
884	10"	889 001 CLR	891 001 CHR	902 001 CHR	890 001	----
	12"	889 002 CLR	891 002 CHR	902 002 CHR	890 002	----
	14"	889 003 CLR	891 003 CHR	902 003 CHR	890 003	----
885	10"	889 001 CLR	891 001 CHR	902 001 CHR	890 001	905
	12"	889 002 CLR	891 002 CHR	902 002 CHR	890 002	905
	14"	889 003 CLR	891 003 CHR	902 003 CHR	890 003	905

**NOTE:** The Spare Part catalog numbers listed above are for the polished chrome (CHR) finish.

To order white finish, replace the "CHR" in the catalog number with the "WHT" finish code.

\*Replacement Retaining Clips (Cat. No. 910) For The Reflector Should Also Be Ordered When Ordering a Replacement Reflector To Assure a Proper Fit.

## 19 INCH SOLAR-RAY® SEARCHLIGHT 1900 SERIES

**ALL ALUMINUM - WHITE PERKO•KOTE FINISH**  
**32, 120 OR 230 VOLTS**

The 1900 Series - Solar-Ray® Searchlights are designed and built with the commercial user in mind where maximum size and brilliance counts. These units are constructed of marine aluminum with heavy duty castings and heavy gauge reinforced bodies for extra durability. They are finished in our white PERKO•KOTE finish; an advanced process that eliminates the need for painting while providing a scratch resistant and chip-proof surface for painting when necessary to match the color of the vessel.

The 1900 Series is available with Deck, Wheel, Lever/Gear or Distant Electric Remote Controls. All models feature halo deflectors, parabolic glass mirror reflectors for maximum light output and ventilation covers for quick dissipation of heat to help prolong bulb life. Hinged front doors have quick release stainless steel latches to provide easy access for bulb replacement.

**Bulbs are not included and must be ordered separately.** PERKO offers a choice of the traditional incandescent or the brighter, more piercing quartz-halogen bulbs in a variety of voltages and wattages. For complete information on bulbs and candlepower output, see page 69.

### "1900 Series" High Power Searchlights Features

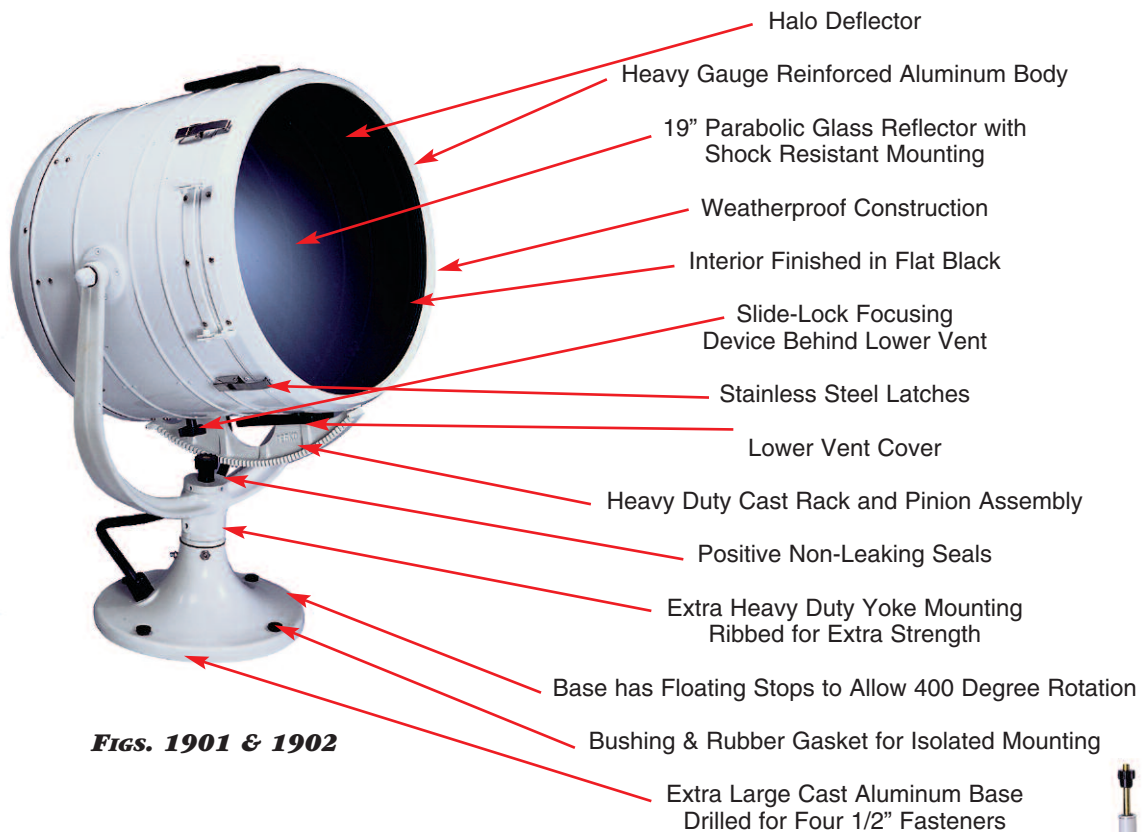

**Figs. 1901 & 1902**



**Fig. 1922**

**WHEEL CONTROL**  
Turn upper wheel for horizontal position. Turn Lower Wheel for vertical position.

### CONTROL TYPES

**DECK CONTROL**  
Equipped with handles on the rear cover for positioning.

**LEVER/GEAR CONTROL**  
Aim handle for horizontal position. Twist handle for vertical position.

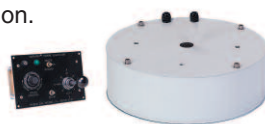

**Fig. 1925**

**DISTANT ELECTRIC CONTROL**



**Fig. 1921**

## 19 INCH SOLAR-RAY® SEARCHLIGHT

### SEARCHLIGHT DIMENSIONS

Nominal Drum Diameter Inches	Nominal Drum Weight Pounds	Nominal Control Weight Pounds
19	68	22



**FIG. 1902 LIGHT  
SHOWN WITH FIG. 1921  
LEVER/GEAR CONTROL**



**FIG. 1902 LIGHT  
SHOWN WITH FIG. 1925  
DISTANT ELECTRIC CONTROL**



**FIG. 1902 LIGHT  
SHOWN WITH FIG. 1922  
WHEEL CONTROL**



**FIG. 1901  
DECK CONTROL**

Base Diameter, 13 Inches.  
Distance Between Wheels, 2-1/2 Inches.

## 19 INCH SOLAR-RAY® SEARCHLIGHT HEAD AND CONTROL ASSEMBLIES

**ALL ALUMINUM - WHITE PERKO•KOTE FINISH**

<b>ORDERING INFORMATION</b>	
Description	Catalog No.
Deck Control Searchlight Head Assembly*	1901 004 WHT
Wheel or Lever/Gear Control Searchlight Head Assembly (Requires Control Assembly Below)	1902 004 WHT
Wheel Control Assembly (For Above)	1922 000 WHT
Lever/Gear Control Assembly (For Above)	1921 000 WHT
Distant Electric Control Assembly (For Above)	1925 000 WHT

\*Cannot Be Fitted With Controls.

Custom Control Lengths and Pedestal Heights Are Available. Price Upon Application. Specify Measurements.

**BULBS ARE NOT INCLUDED IN LIGHTS**

### BULB ORDERING INFORMATION FOR 19 INCH SEARCHLIGHTS

To give good results, the bulb and reflector must be perfectly compatible; therefore be sure to specify the catalog number of the bulb desired. Peak candlepower is exceedingly sensitive to many factors, (i.e., a light source out of focus by 1/32 inch, under-voltage of only 4%, or differences between bulb manufacturers can cause a reduction of range of up to 20%).

For a More Concentrated Beam, Longer Range, Brighter Light and a Longer Life, We Recommend the Quartz/Halogen Bulbs.

Voltage	Approx. Range Miles*	Bulb Catalog Number	Bulb Type	Socket Type	Socket Code Letter	Wattage	Rated Life Hours**	Maximum Candlepower Output	Horizontal Beam Spread Degrees	Vertical Beam Spread Degrees	Mfg. Bulb Code
32	1-2/3	806	Incandescent	Medium Screw	B	500	50	3,520,000	3.5	3.7	DLT
120	1-3/8	837	Incandescent	Medium Prefocus	E	750	200	2,076,000	3.6	4.2	DDY
120	1-5/8	845	Quartz/Halogen	Medium Prefocus	E	750	200	2,871,000	3.6	5.4	BTP
120	1-5/8	807	Incandescent	Medium Prefocus	E	500	25	3,191,000	3.5	4.0	CZX
120	1-2/3	859	Quartz/Halogen	Mogul Prefocus	M	2000	250	3,633,000	9.4	5.9	BVW
120	1-2/3	847	Quartz/Halogen	Mogul Prefocus	M	1000	200	3,659,000	4.5	5.4	BVV
120	1-3/4	844	Quartz/Halogen	Medium Prefocus	E	500	500	3,861,000	3.0	5.4	BTL
120	1-3/4	809	Incandescent	Medium Prefocus	E	750	25	4,569,000	3.6	4.5	DDB
120	1-7/8	846	Quartz/Halogen	Medium Prefocus	E	1000	200	4,601,000	4.5	5.4	BTR
120	2	848	Quartz/Halogen	Mogul Prefocus	L	1500	300	5,596,000	5.9	5.7	DTA
120	2	810	Incandescent	Medium Prefocus	E	1000	25	5,622,000	3.6	4.2	DRS
120	2	839	Quartz/Halogen	2-Pin Prefocus	K	900	75	5,769,000	5.9	5.4	BVA
230	1-3/8	860	Quartz/Halogen	Medium Prefocus	E	1000	950	2,162,000	7.9	6.5	FKD

\*The approximate ranges listed above are based on photometric measurements of beam candlepower output under ideal conditions. Many factors such as atmospheric conditions, size and color of target, background, etc., may reduce effective range considerably; therefore, these figures are offered only as a guide to compare different bulb and voltage options.

**PLEASE ORDER CAREFULLY, BULBS ARE NOT RETURNABLE.**

\*\*NOTE: These are the "Rated Average Laboratory Life in Hours" of the Bulb Manufacturer obtained in closely controlled laboratory life testing of groups of lamps at their design voltage. It is not necessarily the same as the service life where conditions such as shock, vibration, voltage fluctuation and environment may result in a shorter average attained life.

### ELECTRIC SOCKET AND SUPPORT STAND ASSEMBLIES FOR 19 INCH SEARCHLIGHTS

Solar-Ray® Searchlights include a socket and support stand based on the bulb or socket information given when ordering. The following chart makes it possible to order and stock different assemblies for field conversion, to meet a large variety of voltage and candlepower requirements with a minimum of inventory.

<b>ORDERING INFORMATION</b>			
Socket Type	Socket Code	Socket & Stand Catalog Number	Height Stand Inches
Medium Screw	B	872 004	5-3/4
Medium Prefocus	E	873 004	5-7/16
Mogul Prefocus (1500 Watt)	L	1930 004	3-5/8
Mogul Prefocus (1000 & 2000 Watt)	M	1931 004	3-1/8
2-Pin Prefocus (900 Watt)	K	880 004	7-5/16

## SPARE PARTS FOR 1900 SERIES SOLAR-RAY® SEARCHLIGHTS

### ORDERING INFORMATION

Fig. No.	Front Glass Cat. No.	Front Door with Glass Cat. No.	Rear Cover Cat. No.	Reflector* Cat. No.	Pinion Gear Cat. No.
1901	889 004 CLR	1936 000 WHT	1932 000 WHT	890 004	----
1902	889 004 CLR	1936 000 WHT	1933 000 WHT	890 004	905

\*Replacement Retaining Clips (Cat. No. 911) for the Reflector Should Also Be Ordered When Ordering a Replacement Reflector to Assure a Proper Fit.

### SPARE SOCKETS

#### FOR 800 SERIES AND 1900 SERIES SOLAR-RAY® SEARCHLIGHTS

### ORDERING INFORMATION



Medium Screw Socket  
(Code "B")  
Catalog No. 894.



Medium Prefocus Socket  
(Code "E")  
Catalog No. 895.

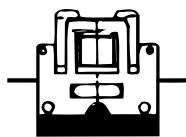

2-Pin Prefocus Socket  
(Codes "F, G, H & I"\*)  
Catalog No. 899.

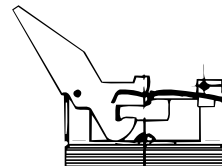

2-Pin Prefocus Socket  
(Code "K"\*\*)   
Catalog No. 866.



Mogul Screw Socket  
(Code "D")  
Catalog No. 897.

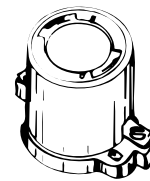

Mogul Prefocus Socket  
(Codes "L & M")  
Catalog No. 893.

\*For Use In 10", 12" and 14" Searchlights Except When Catalog No. 839, 900 Watt Bulb is Used.

\*\*For Use In 12", 14" and 19" Searchlights Only When the Catalog No. 839, 900 Watt Bulb is Used.

## VARO-RAY™ XENON SEARCHLIGHTS

**15" HOUSINGS - 500 WATT, 110 OR 220 VAC POWER SUPPLIES**  
**19" HOUSINGS - 1600 WATT, 220 OR 440 VAC POWER SUPPLIES**

VARO-Ray Xenon Searchlights are designed and manufactured to meet the demanding needs of commercial marine applications. The short arc Xenon filled lamps produce an extremely bright and very white light which can be focused in the pilothouse into a narrow long range beam. The heavy duty head of the 1,600 watt light is a marine grade aluminum casting with integral cooling fins to assure cool operation at high output levels. The cast marine aluminum yoke & base are equally rugged. High quality Timkin bearings provide for smooth 380° rotation.

The VARO-Ray 9854 Series is available manually controlled with a traditional lever gear control system or remotely controlled with a distant electric control system. In addition, an optional heating capability is available to assure trouble free operation in areas of the world prone to icing conditions. The 9854 Series searchlight can be operated continuously at 1,600 watts for maximum brightness providing in excess of 100,000,000 candle power and up to 5.5 mile (IES Handbook) range. The 9304 series searchlight can be operated continuously at 500 watts for a maximum brightness of 35,000,000 candlepower and over 3 1/2 mile (ES Handbook) range. An iridium coated precision reflector provides for maximum light output and sharp focus. The remote control panel controls lamp ignition (start-up) and focus from the pilot house. Superior cooling is provided by a heavy duty cooling fan which blows air across the lamp inside the sealed housing.

Both Series Searchlights include a single Xenon lamp. Perko offers a choice of several replacement lamps (800, 1,000 & 1,600 watt) which will operate in the series 9854 searchlight when the proper amperage settings have been chosen. For the 9304 series, a 500 watt Xenon lamp is the only available option.

**FIG. 9304 - 500 WATT**

**FIG. 9854 - 1600 WATT**

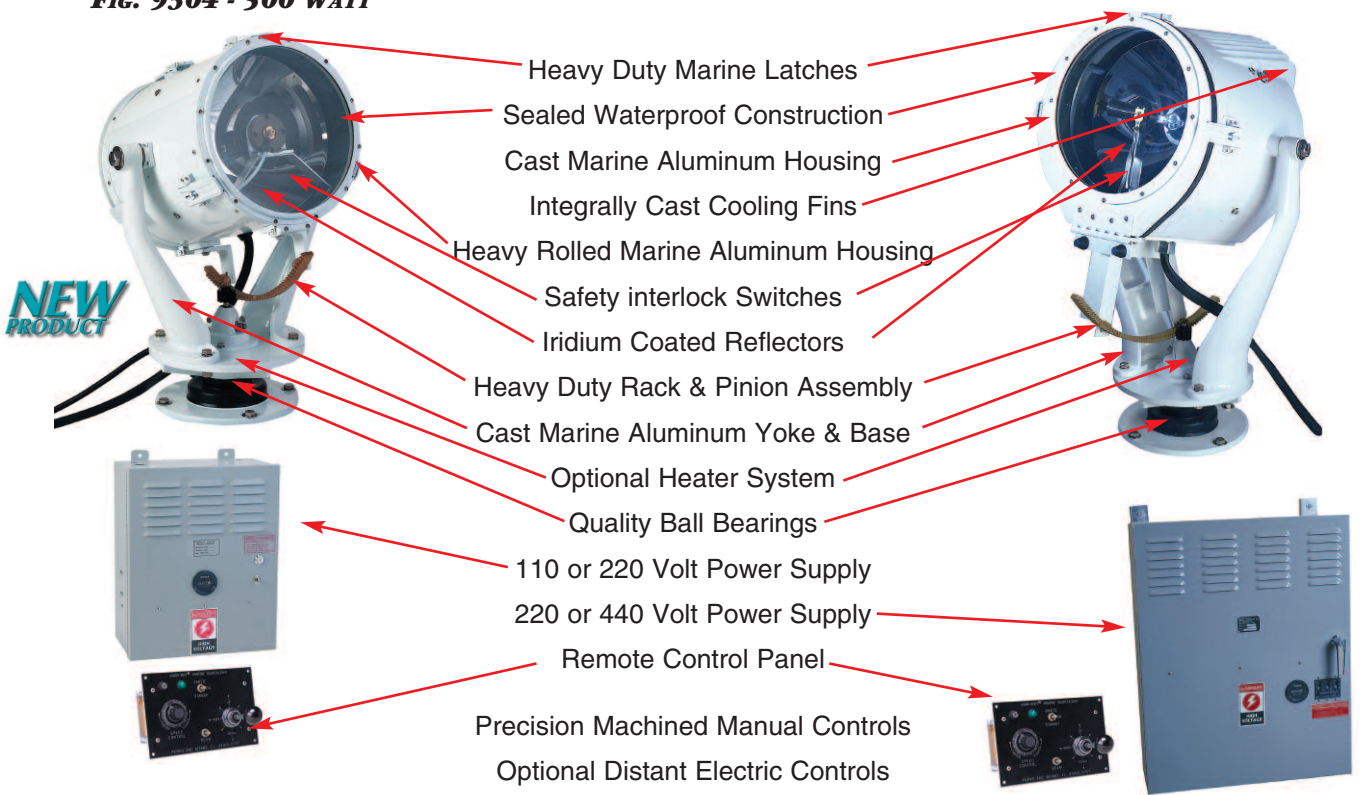

**FIG. 9304 & 9854 CONTROL TYPES**

### Lever Gear

Aim handle for horizontal position. Twist handle for vertical position.



### REMOTE ELECTRIC

Joystick type controller for both horizontal & vertical positioning



## VARO-RAY™ 15" XENON SEARCHLIGHTS

(500 WATT) WITH 120 OR 220 VAC POWER SUPPLY

### SEARCHLIGHT DIMENSIONS

17-3/4"  
Front to Back

Nominal Drum  
Diameter  
Inches  
13-3/4

Nominal Searchlight  
Assembly Weight  
Pounds  
71

13-3/4"

**NEW  
PRODUCT**

**FIG. 9304 LIGHT  
SHOWN WITH  
REMOTE DISTANT  
ELECTRIC CONTROL  
BASE**

**FIG. 9304 LIGHT  
SHOWN WITH  
LEVER/GEAR  
CONTROL**

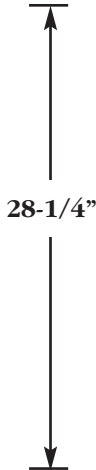
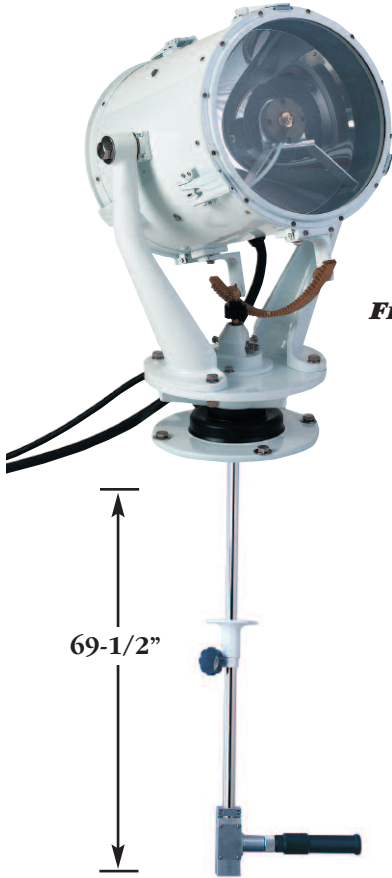

**FIG. 9304  
HEAD, YOKE AND BASE ASSEMBLY**



**FIG. 9511-000  
500 WATT POWER SUPPLY**

**Gross Shipping Weight**

Including Crate	Pounds
Searchlight	130 Lbs
Power Supply	100 Lbs
Control Rod & Tube	19 Lbs

Base Diameter, 12 Inches.

### Complete VARO-Ray™ Searchlight

#### ORDERING INFORMATION With Distant Electric Control Base

Lamp Type & Lamp Size	Voltage	Catalog No. Without Heaters	Catalog No. With Heaters
500 Watt Xenon	120 VAC	9304-E01-WH5	9304-EH1-WH5
500 Watt Xenon	220 VAC	9304-E02-WH5*	9304-EH2-WH5*

#### ORDERING INFORMATION With Lever/Gear Controls

Lamp Type & Lamp Size	Voltage	Catalog No. Without Heaters	Catalog No. With Heaters
500 Watt Xenon	120 VAC	9304-L01-WH5	9304-LH1-WH5
500 Watt Xenon	220 VAC	9304-L02-WH5*	9304-LH2-WH5*

**NOTE: Lamps are included with complete Searchlights.**

\* 500 Watt 220 Power Supply Ships 60hz unless 50hz is requested.



## VARO-RAY™ 19" XENON SEARCHLIGHTS

(1600 WATT) WITH 220 & 440 (3Ø) VAC POWER SUPPLIES

### SEARCHLIGHT DIMENSIONS

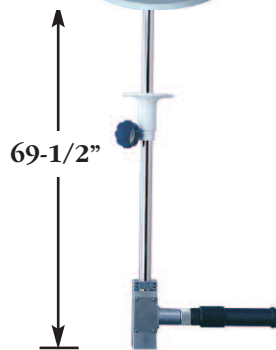

**FIG. 9854 LIGHT SHOWN WITH LEVER/GEAR CONTROL**

Nominal Drum Diameter Inches	Nominal Searchlight Assembly Weight Pounds
19	145



**FIG. 9854 LIGHT SHOWN WITH REMOTE DISTANT ELECTRIC CONTROL BASE**



**FIG. 9854 HEAD, YOKE AND BASE ASSEMBLY**



**FIG. 9512 POWER SUPPLY**

<b>Gross Shipping Weight</b>	<b>Pounds</b>
Searchlight	258 Lbs
Power Supply	264 Lbs
Control Rod & Tube	19 Lbs

Base Diameter, 12 Inches.

### Complete VARO-Ray™ Searchlight

#### ORDERING INFORMATION With Distant Electric Control Base

Lamp Type & Lamp Size	Voltage	Catalog No. Without Heaters	Catalog No. With Heaters
800 Watt Xenon	220 VAC	9854-E02-WH8	9854-EH2-WH8
1000 Watt Xenon	220 VAC	9854-E02-WH0	9854-EH2-WH0
1600 Watt Xenon	220 VAC	9854-E02-WH6	9854-EH2-WH6
800 Watt Xenon	440 VAC	9854-E04-WH8	9854-EH4-WH8
1000 Watt Xenon	440 VAC	9854-E04-WH0	9854-EH4-WH0
1600 Watt Xenon	440 VAC	9854-E04-WH6	9854-EH4-WH6

#### ORDERING INFORMATION With Manual Lever Control

Lamp Type & Lamp Size	Voltage	Catalog No. Without Heaters	Catalog No. With Heaters
800 Watt Xenon	220 VAC	9854-L02-WH8	9854-LH2-WH8
1000 Watt Xenon	220 VAC	9854-L02-WH0	9854-LH2-WH0
1600 Watt Xenon	220 VAC	9854-L02-WH6	9854-LH2-WH6
800 Watt Xenon	440 VAC	9854-L04-WH8	9854-LH4-WH8
1000 Watt Xenon	440 VAC	9854-L04-WH0	9854-LH4-WH0
1600 Watt Xenon	440 VAC	9854-L04-WH6	9854-LH4-WH6

**NOTE: Lamps are included with complete Searchlights.**

## VARO-RAY™ XENON SEARCHLIGHTS

### MAJOR COMPONENT ORDERING INFORMATION

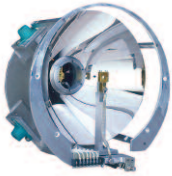

**FIG. 9521-000**



**FIG. 9501-000**  
**19" HEAD ASSY**



**FIG. 9504-000**  
**15" HEAD ASSY**



**FIG. 9506-000**  
**19" ASSY YOKE**



**FIG. 9508-000**  
**15" ASSY YOKE**

A unique design feature of the 1600 Watt V A R O - R a y ™ Searchlight is the ease with which the optical assembly can be changed. By removing a few bolts and easily accessible wires, the entire assembly comes out the front of the searchlight as one complete unit. Even older VARO-Ray™ lights can be upgraded to current technology with just a simple swap out of optical assemblies and power supplies.

### SEARCHLIGHT HEAD AND OPTICAL COMPONENTS

Catalog Number	Description
9504-000	Complete 15" Searchlight Head with Optical Assembly.
9508-000	15" Searchlight Yoke & Base Assembly Only.
9501-000	Complete 19" Searchlight Head with Optical Assembly.
9506-000	19" Searchlight Yoke & Base Assembly Only.
9521-000	Removable 1,600 Watt Optical Assembly.

### POWER SUPPLY COMPONENTS

Catalog Number	Description
9511-000-000	500 Watt-110 Volt Power Supply
9511-000-220	500 Watt-220 Volt Power Supply
9510-000-220	1,000 Watt-220 Volt (3Ø) Power Supply
9510-000-440	1,000 Watt-440 Volt (3Ø) Power Supply
9512-000	1,600 Watt-220 Volt (3Ø) Power Supply
9514-000	1,600 Watt-440 Volt (3Ø) Power Supply



**FIGS.**  
**9512-000**  
**&**  
**9514-000**  
**1600 WATT**  
**POWER SUPPLIES**



**FIG. 9511-000**  
**500 WATT**  
**POWER SUPPLY**

VARO-Ray™ power supplies are made using high quality, durable components. Power supply units can be easily exchanged for factory rebuilt units offering a low cost means of repairing or upgrading older units in the field. All power supplies include a remote panel for controlling lamp ignition and focus.

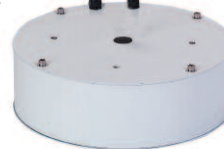

**FIG. 9530**

**LEVER CONTROL**  
**HANDLE**



**FIG. 9551-000**  
**DISTANT ELECTRIC**  
**CONTROL BASE**



### CONTROL COMPONENTS

Catalog Number	Description
9530-000	Standard Length Lever Gear Mechanical Controls for Fig. 9854.
9551-000	Remote Distant Electric Controls for Fig. 9854.
9551-001	Additional Slave Controller for Distant Electric Control.

VARO-Ray™ lights can be controlled using conventional mechanical lever gear controls or upgraded to remote distant electric control systems. The standard length for lever gear systems is 72 inches. Custom lengths are available. In either case searchlight movement is 380° horizontal and 70° vertical.



**FIG. 9582-001**



**FIG. 9582-002**



**FIG. 9582-003**

### SEARCHLIGHT TOOLS

Catalog Number	Description
9582-001	9/64" Hex (Lamp Changing) Tool.
9582-002	500 Watt and 1KW Lamp Extractor Tool.
9582-003	1/4" x 10" Reflector Adjusting Wrench.
9582-005	Spare Emulator Kit for Fig. 9854 (See Manual Fig. 9581-001 for item list).

A number of custom produced tools make working with and on VARO-Ray™ searchlights easier. One of the best (and safest) ways to evaluate the performance of older units in the field is with the Xenon lamp emulator kit which simulates Xenon lamps while running and during start-up. Other tools help adjust focus and install lamps.

## VARO-RAY™ XENON SEARCHLIGHTS

### ADDITIONAL COMPONENT ORDERING INFORMATION

#### TRANSFORMERS



Fig. 9510-001  
Accessory Transformer



Fig. 9510-013  
Main Power Transformer



Fig. 9521-009  
Excitation Transformer

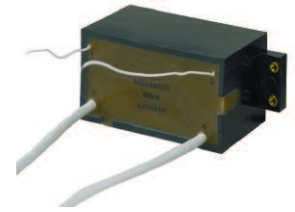

Fig. 9521-017  
Injection Transformer

#### METERS, GAUGES & CONTROL PANELS



Fig. 9510-009  
Remote Ammeter



Fig. 9510-003  
Hour Meter



Fig. 9510-010  
Control Panel  
Assembly



Fig. 9551-007  
Distant Electric  
Base Control Panel



Fig. 9551-001  
Slave Controller

#### FANS, SPARK GAP ASSEMBLY & SWITCHES



Fig. 9510-011  
Power Supply Fan



Fig. 9521-008  
Optical Assembly Fan

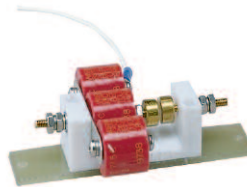

Fig. 9521-003  
Spark Gap Assembly



Fig. 9510-005  
Ignite Toggle  
Switch

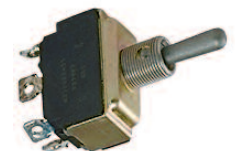

Fig. 9510-006  
Beam Focus Switch

#### MANUALS

Catalog Number	Description
9581-001	Installation Manual - For Fig. 9854 Complete Searchlights.
9581-002	Installation Manual - For Fig. 9551 Remote Distant Electric Control Unit.
9581-003	Installation Manual - For Figs. 9501 & 9521 Head and Optical Assemblies.
9581-004	Installation Manual - For Fig. 9304 Complete Searchlights.



## VARO-RAY™ XENON SEARCHLIGHTS

### VARO-Ray™ Xenon Lamp ORDERING INFORMATION



#### **WARNING!!**

Xenon lamps are filled with Xenon Gas under high pressure. They may explode in either hot or cold state, especially if dropped or mishandled. **ALWAYS** wear protective safety equipment (a protective face mask with neck guard, chest protector, heavy clothing and leather gloves) when handling a lamp.

### AMPERAGE RATINGS

Xenon Lamp Size	Catalog Number	Current Range	Recommended Operation	Candle Power	Range Miles
300 Watt*	9563-000	12A - 16A	15A @ 20V	20,000,000	3.1
500 Watt*	9565-000	20A - 30A	30A @ 15V	35,000,000	3.8
800 Watt	9568-000	30A - 45A	37A @ 19V	65,000,000	4.5
1000 Watt	9560-000	30A - 55A	50A @ 20V	80,000,000	5.1
1600 Watt	9566-000	50A - 70A	65A @ 24V	100,000,000	5.5

\* 300W and 500W lamps shown as replacements on VARO 300W and 500W Searchlights only - Not used on 9854 Series Searchlights.

#### LAMP WARRANTIES REQUIRE COMPLETION OF WARRANTY REGISTRATION FORMS SHORTLY AFTER PURCHASE AND INSTALLATION

PERKO Purchase Notification
Purchase Price _____
Date Completed _____
Date of Purchase _____
Authorized Dealer _____
Motor Vessel Name _____
<b>PERKO Inc.</b> Miami, FL. 33169

PERKO Warranty Registration
Purchase Price _____
Hour Meter Reading _____
Date of Installation _____
Authorized Dealer _____
Motor Vessel Name _____
<b>PERKO Inc.</b> Miami, FL. 33169

**NOTE:** PERKO offers a limited warranty on both the shelf and operating life of the VARO-Ray™ Xenon lamps. Please see the VARO-Ray™ "Limited Eighteen (18) Month Warranty" for all explicit terms and conditions of this warranty.

All VARO-Ray™ Xenon lamps are supplied with an adapter sized to fit VARO-Ray™ Searchlights. Adapters for other searchlights can be manufactured upon request. Contact customer service for details.

## DOME LIGHTS

**FIG. 300 - SURFACE MOUNT DOME LIGHT**

**FIG. 1253 - EXTERIOR SURFACE MOUNT DOME LIGHT**

**CONSTRUCTION:**

**FIG. 300 - CHROME PLATED ZINC ALLOY**  
**FIG. 1253 - IVORY PERKO•KOTE ZINC ALLOY**

- \* **DOUBLE CONTACT BAYONET SOCKET**
- \* **BLACK VINYL MOUNTING GASKET**
- \* **PUSH SWITCH WITH WATER RESISTANT BOOT**
- \* **12 VOLT BULB INCLUDED**



**FIG. 300**



**FIG. 1253**



**ORDERING INFORMATION**

O.D. Globe Inches	O.D. Base Inches	Depth Overall Inches	Wattage of Bulb Supplied	Maximum Wattage	Dealer Pkg. - 5 Cards 1 Pc. per Card	OEM Bulk Pkg. 10 Pcs.	Screw Size	Weight Ounces
3	3-3/4	1-1/2	7	11	300 DP0 CHR	300 000 CHR*	10 R.H.	7
4	5	1-7/8	11	17	300 DP1 CHR	300 001 CHR	10 R.H.	9
5	6	2	17	17	300 DP2 CHR	300 002 CHR	12 R.H.	11
4	5	1-7/8	11	17	1253 DP1 WHT	1253 001 WHT	10 R.H.	9
5	6	2	17	17	1253 DP2 WHT	1253 002 WHT	12 R.H.	11

\*OEM Bulk Pkg., 20 Pcs.

Spare Bulbs (2 per card) for 3 Inch Light, Cat. No. 337 011 DP.  
 Spare Bulbs (2 per card) for 4 Inch Light, Cat. No. 337 012 DP.  
 Spare Bulbs (2 per card) for 5 Inch Light, Cat. No. 337 013 DP.

Spare Switch, Cat. No. 701 DP.  
 Spare Socket, Cat. No. 24 DP1.  
 Spare Globe, Cat. No. 257 DP, Specify Size.

**NOTE: TO USE FIGS 300 & 1253 IN A 24 VOLT SYSTEM, ORDER REPLACEMENT BULBS (1 PER CARD) CAT. NO. 337 014 DP.**

**FIG. 1258 - ROUND SURFACE MOUNT DOME LIGHT**

**FIG. 1260 - SQUARE SURFACE MOUNT DOME LIGHT**

**CONSTRUCTION:**

- \* **CHROME PLATED ZINC ALLOY**
- \* **WHITE TRANSLUCENT PLASTIC GLOBE**
- \* **PUSH SWITCH WITH WATER RESISTANT BOOT**
- \* **12 VOLT, 10 WATT BULB INCLUDED**



**FIG. 1258**



**FIG. 1260**



**ORDERING INFORMATION**

O.D. Base Inches	Depth Overall Inches	Maximum Wattage	Dealer Pkg. - 5 Cards 1 Pc. per Card	OEM Bulk Pkg. 10 Pcs.	Screw Size	Weight Ounces
3-3/4	1-1/4	10	1258 DP2 CHR	1258 002 CHR	8 R.H.	7
Dimensions Base Inches	Depth Overall Inches	Maximum Wattage	Dealer Pkg. - 5 Cards 1 Pc. per Card	OEM Bulk Pkg. 10 Pcs.	Screw Size	Weight Ounces
3-5/8 x 4-1/4	1-1/4	10	1260 DP2 CHR	1260 002 CHR	8 R.H.	10

Spare Bulbs (2 per card), Cat. No. 70 DP0 CLR.  
 Spare Globe Fig. No. 1258, Cat. No. 244 002 WHT.

Spare Switch, Cat. No. 701 DP.  
 Spare Globe Fig. No. 1260, Cat. No. 245 002 WHT.

**NOTE: TO USE THESE LIGHTS IN A 24 VOLT SYSTEM, ORDER REPLACEMENT BULBS (2 PER CARD) CAT. NO. 67 DP1 CLR.**

## DOME LIGHTS

### FIG. 555 - SURFACE MOUNT DOME LIGHT



**FIG. 555**

#### ORDERING INFORMATION

O.D. Globe Inches	O.D. Base Inches	Depth Inches	Standard Pkg. - 1 Pc.	Screw Size	Weight Pounds
6	7-7/8	3-1/8	555 000 CHR	8	4-1/2

Spare Switch, Cat. No. 514 DP.  
 Spare Socket, Cat. No. 276 000.  
 Spare Globe, Cat. No. 257 DP6.  
 Refer to Page 91 for Bulb Selection.

### FIG. 753 - SURFACE MOUNT DOME LIGHT



**FIG. 753**

#### CONSTRUCTION:

- \* CHROME PLATED WROUGHT BRASS
- \* MEDIUM SCREW SOCKET, TOGGLE SWITCHES
- \* BULBS NOT INCLUDED.
- \* FOR SYSTEMS UP TO 50 VOLTS.

\* SIZE NO. 1 HAS ONE SOCKET AND SWITCH.  
 WILL ACCOMMODATE ONE BULB UP TO 50 WATTS.

\* SIZE NO. 2 HAS TWO SOCKETS AND SWITCHES.  
 WILL ACCOMMODATE TWO BULBS UP TO 25 WATTS EACH.

#### ORDERING INFORMATION

O.D. Glass Inches	O.D. Base Inches	Depth Inches	Standard Pkg. - 1 Pc.	Screw Size	Weight Pounds
8	9-1/2	3	753 001 CHR	10 R.H.	2-1/2
8	9-1/2	3	753 002 CHR	10 R.H.	2-3/4

Spare Switch, Cat. No. 514 DP.  
 Spare Socket, Cat. No. 1323.  
 Spare Globe, Cat. No. 132 000 FRD.  
 Refer to Page 91 for Bulb Selection.

## SURFACE MOUNT & UTILITY LIGHTS

**FIG. 318 - SURFACE MOUNT LIGHT**

**CONSTRUCTION:**

- \* **WHITE TRANSLUCENT PLASTIC COVER**
- \* **WHITE PERKO•KOTE CAST ZINC ALLOY BASE WITH INTEGRAL JUNCTION BOX**
- \* **DUAL VOLTAGE, FOR 12 AND 120 VOLTS**
- \* **DOUBLE CONTACT BAYONET SOCKETS**
- \* **COMPLETE WITH TWO 12 VOLT, 11 WATT AND TWO 120 VOLTS, 15 WATT BULBS**



**FIG. 318**



**ORDERING INFORMATION**

Length Inches	Width Inches	Depth Inches	Dealer Pkg. - 5 Cards 1 Pc. per Card	OEM Bulk Pkg. 10 Pcs.	Screw Size	Weight Pounds
9-3/4	3-1/2	1-7/8	318 DP	318 A00	10	1-5/8

Spare 12 Volt Bulbs (2 per card), Cat. No. 337 012 DP. Spare Socket, Cat. No. 24 DP1.  
 Spare 120 Volt Bulbs (2 per card), Cat. No. 337 023 DP. Spare Globe, Cat. No. 318 A00 99D.  
 Spare Switches with Square Buttons (1 Each High and Low), Cat. No. 318 A00 99E.

**FIGS. 1087 & 1090 - VAPOR PROOF LIGHT FIXTURES**

**CONSTRUCTION:**

- \* **SATIN FINISH DIE CAST ALUMINUM WITH GLASS GLOBES.**
- \* **INTEGRAL JUNCTION BOX WITH FOUR 1/2 INCH I.P.S. FITTINGS.**
- \* **MEDIUM SCREW SOCKET FOR BULBS UP TO 100 WATTS.**
- \* **BULB NOT INCLUDED.**

**FIG. 1087, CEILING MOUNT.**  
**FIG. 1090, BULKHEAD MOUNT.**



**FIG. 1090**



**FIG. 1087**

**ORDERING INFORMATION**

O.D. Box Inches	Length Overall Inches	Projection Inches	Standard Pkg. - 1 Pc.	Bolt Size	Weight Pounds
3-3/4	9-1/2	---	1087 000 ALU	1/4	3
3-3/4	10	7	1090 000 ALU	1/4	3-1/4

Note: These Fixtures are listed in accordance with U.L. Standard 57, for enclosed gasketed fixtures. **Not** evaluated for use in hazardous or explosive atmospheres.

Spare Guards, Cat. Nos. 1087 000 99A and 1090 000 99A.  
 Spare Sockets, Cat. Nos. 1087 000 99B and 1090 000 99B.  
 Spare Globes, Cat. Nos. 1087 000 99C and 1090 000 99C.  
 Refer to Page 91 for Bulb Selection.

## UTILITY LIGHTS

**FIG. 1146 - "REDUCED GLARE" DESIGN COCKPIT LIGHT**



**FIG. 1146  
CHROME**



**FIG. 1146  
WHITE PLASTIC**

**CONSTRUCTION OPTIONS:**

- \* **CHROME PLATED BRASS WITH BLACK PLASTIC BASE**
- \* **WHITE PLASTIC WITH BLACK PLASTIC BASE**
- \* **12, 24 OR 32 VOLT BULB INCLUDED.**
- \* **DESIGNED TO DIRECT 80% OF THE LIGHT DOWNWARD, THUS REDUCING COCKPIT GLARE.**
- \* **INSTALLS IN A 2-1/8" DIAMETER HOLE.**



**ORDERING INFORMATION**

Finish	O.D. Overall Inches	Depth Inches	Voltage	Dealer Pkg. 5 Cards 1 Pc. per Card	OEM Bulk Package 25 Pcs.	Screw Size	Weight Ounces
Chrome	3	1	12	1146 DP1 12V	1146 001 12V	8	4
Chrome	3	1	24	1146 DP2 24V	1146 002 24V	8	4
Chrome	3	1	32	1146 DP3 32V	1146 003 32V	8	4
White	3	1	12	1146 DP1 WHT	1146 001 WHT	8	4
White	3	1	24	1146 DP2 WHT	1146 002 WHT	8	4
White	3	1	32	1146 DP3 WHT	1146 003 WHT	8	4

Spare 12 Volt Bulbs (2 Per Card), Cat. No. 70 DP0 CLR.  
Spare 24 Volt Bulbs (2 Per Card), Cat. No. 67 DP1 CLR.  
Spare 32 Volt Bulbs (2 Per Card), Cat. No. 70 DP2 CLR.

Spare Socket Assembly, Cat. No. 1146 000 99B.  
Spare Lens with Gasket, Cat. No. 1146 DP 99A.  
Spare Mounting Flange, Cat. No. 946 000 99C.

**FIG. 1254 - ADJUSTABLE UTILITY LIGHT**



**FIG. 1254**

**CONSTRUCTION:**

- \* **CHROME PLATED ZINC ALLOY**
- \* **SHIELD SWIVELS TO CHANGE POSITION**
- \* **12 VOLT, 7 WATT BULB INCLUDED**



**ORDERING INFORMATION**

O.D. Overall Inches	Length Neck Inches	O.D. Neck Inches	Dealer Pkg. - 5 Cards 1 Pc. per Card	Screw Size	Weight Ounces
2-5/8	3/4	7/8	1254 DP CHR	6	6

Spare Bulbs (2 per card), Cat. No. 337 011 DP.  
Spare Socket, Cat. No. 24 DP1.

**FIG. 137/140 - SURFACE MOUNT UTILITY LIGHT**



**FIG. 137**



**FIG. 140**

**CONSTRUCTION OPTIONS:**

- FIG. 137 - MOLDED BLACK PLASTIC**
- \* **SHIELDED LIGHT COVER**
- FIG. 140 - MOLDED WHITE PLASTIC**
- \* **DIFFUSED LIGHT COVER**

- \* **12 VOLT, 1 WATT BULB INCLUDED**



**ORDERING INFORMATION**

Dimensions Inches	Dealer Pkg.-10 Cards 1 Pc. per Card	OEM Bulk Pkg. 100 Pcs.	Screw Size	Weight Ounces
1-7/8 x 9/16	137 DP BLK	137 000 BLK	6 R.H.	1/2
1-7/8 x 9/16	140 DP NYN	140 000 NYN	6 R.H.	1/2



LIGHTING FIXTURES, BULBS AND BATTERY SWITCHES



## UTILITY LIGHTS

### FIG. 1044 - FLUSH UTILITY LIGHT

#### CONSTRUCTION OPTIONS:

- \* **BLACK MOLDED PLASTIC**
- \* **WHITE MOLDED PLASTIC**
- \* **DIFFUSION LENS**
- \* **SNAP-ON FRONT COVER CONCEALS MOUNTING SCREWS**
- \* **12 VOLT, 3 WATT BULB INCLUDED**
- \* **INSTALLS IN A 1-3/4" DIAMETER HOLE**

**No. 1 SUPPLIED WITH 1/4" SPADE CONNECTORS**

**No. 2 SUPPLIED WITH 7" WIRE LEADS**



**FIG. 1044 BLACK**



**FIG. 1044 WHITE**

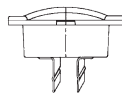

Spade Connectors (#1 Style)

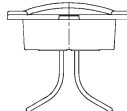

Pig Tail Leads (#2 Style)



#### ORDERING INFORMATION

Color	Dimensions Inches	Depth Inches	Dealer Pkg. - 10 Cards 1 Pc. per Card	OEM Bulk Pkg. 100 Pcs.	Weight Ounces
Black	2-1/4 x 2-1/4	15/16	1044 DP1 BLK	1044 001 BLK	1
Black	2-1/4 x 2-1/4	15/16	1044 DP2 BLK	1044 002 BLK	1
White	2-1/4 x 2-1/4	15/16	1044 DP1 WHT	1044 001 WHT	1
White	2-1/4 x 2-1/4	15/16	1044 DP2 WHT	1044 002 WHT	1

Screw Size, No. 6.

Spare Bulb, Cat. No. 1044 DP 99A. (2 Per Card)



### FIG. 1064 - FLUSH UTILITY LIGHT

#### CONSTRUCTION OPTIONS:

- \* **BLACK MOLDED PLASTIC**
- \* **WHITE MOLDED PLASTIC**
- \* **DIFFUSION LENS**
- \* **12 VOLT, 3 WATT BULB INCLUDED**
- \* **INSTALLS IN A 1-3/4" DIAMETER HOLE**

**No. 1 SUPPLIED WITH 1/4" SPADE CONNECTORS**

**No. 2 SUPPLIED WITH 7" WIRE LEADS**



**FIG. 1064 BLACK**



**FIG. 1064 WHITE**

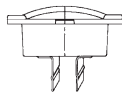

Spade Connectors  
(#1 Style)



Pig Tail Leads  
(#2 Style)



#### ORDERING INFORMATION

Color	Dimensions Inches	Depth Inches	Dealer Pkg. - 10 Cards 1 Pc. per Card	OEM Bulk Pkg. 100 Pcs.	Weight Ounces
Black	2-1/4 x 2-1/4	15/16	1064 DP1 BLK	1064 001 BLK	1
Black	2-1/4 x 2-1/4	15/16	1064 DP2 BLK	1064 002 BLK	1
White	2-1/4 x 2-1/4	15/16	1064 DP1 WHT	1064 001 WHT	1
White	2-1/4 x 2-1/4	15/16	1064 DP2 WHT	1064 002 WHT	1

Screw Size, No. 6.

Spare Bulb, Cat. No. 1044 DP 99A. (2 Per Card)



## SPREADER LIGHTS

### FIG. 1040 - ADJUSTABLE SPREADER LIGHT

**CONSTRUCTION:**

- \* **MOLDED BLACK PLASTIC BODY**
- \* **CHROME PLATED BRASS MOUNTING BRACKET**
- \* **SCREW IN LENS RETAINING RING FOR EASE OF RE-BULBING**
- \* **12 VOLT, 24 OR 32 VOLT SEALED BEAM UNIT INCLUDED**



**Fig. 1040**



**ORDERING INFORMATION**

Voltage	O.D. Inches	Depth Inches	Dimensions		Cards per Pkg.	OEM		Weight Pounds
			Bracket Inches	Dealer Pkg. 1 Pc. per Card		Bulk Pkg. 10 Pcs.		
12	4-1/2	4-1/2	4-1/2 x 1	1040 DP1 12V	5	1040 001 12V	1-1/2	
24	4-1/2	4-1/2	4-1/2 x 1	1040 DP2 24V	2	1040 002 24V	1-1/2	
32	4-1/2	4-1/2	4-1/2 x 1	1040 DP3 32V	2	1040 003 32V	1-1/2	

Screw Size, No. 12 R.H.  
 Spare Sealed Beam Unit (12 Volt), Cat. No. 432 001 12V.  
 Spare Sealed Beam Unit (24 Volt), Cat. No. 432 002 24V.  
 Spare Sealed Beam Unit (32 Volt), Cat. No. 432 003 32V.

### FIG. 280 - ADJUSTABLE SPREADER LIGHT

**CONSTRUCTION:**

- \* **CHROME PLATED BRASS**
- \* **12, 24 OR 32 VOLT SEALED BEAM UNIT INCLUDED**



**Fig. 280**



**ORDERING INFORMATION**

Voltage	O.D. Inches	Depth Inches	Dimensions		Cards per Pkg.	OEM		Weight Pounds
			Bracket Inches	Dealer Pkg. 1 Pc. per Card		Bulk Pkg. 10 Pcs.		
12	4-5/8	2-1/2	5-3/8 x 3/4	280 DP1 12V	5	280 001 12V	1-1/8	
24	4-5/8	2-1/2	5-3/8 x 3/4	280 DP2 24V	2	280 002 24V	1-1/8	
32	4-5/8	2-1/2	5-3/8 x 3/4	280 DP3 32V	2	280 003 32V	1-1/8	

Screw Size, No. 12 R.H.  
 Spare Sealed Beam Unit (12 Volt), Cat. No. 432 001 12V.  
 Spare Sealed Beam Unit (24 Volt), Cat. No. 432 002 24V.  
 Spare Sealed Beam Unit (32 Volt), Cat. No. 432 003 32V.

### FIG. 265 - FIXED SPREADER LIGHT

**CONSTRUCTION:**

- \* **CHROME PLATED BRONZE**
- \* **12 VOLT, 10 WATT BULB INCLUDED**



**Fig. 265**



**ORDERING INFORMATION**

O.D. Inches	Depth Inches	Dealer Pkg. - 5 Pcs. 1 Pc. per Pkg.	OEM Bulk Pkg. 10 Pcs.	Screw Size	Weight Ounces
2-3/4	1-3/8	265 DP CHR	265 000 CHR	6	5

Spare Bulbs (2 per card), Cat. No. 70 DP0 CLR.  
 Spare Socket Assembly, Cat. No. 265 000 99A.  
 Spare Lens with O-Ring, Cat. No. 284 DP CLR.

**FOR REPLACEMENT BULB INFORMATION REFER TO PAGE 91.**

## BULKHEAD LIGHTS

### FIG. 217 - BULKHEAD LIGHT FIXTURES

**CONSTRUCTION:**

- \* CHROME PLATED ZINC ALLOY
- \* MEDIUM SCREW SOCKET
- \* TURN SWITCH
- \* BULB NOT INCLUDED

**FOR SYSTEMS UP TO 50 VOLTS**



**FIG. 217**



### ORDERING INFORMATION

Dimensions Base Inches	Projection Less Lamp Inches	Dealer Pkg. - 5 Cards 1 Pc. per Card	Screw Size	Weight Ounces
2-1/2 x 1-3/4	2-5/8	217 DP CHR	6 R.H.	8

Spare Bulb Socket with Switch, Cat. No. 223.  
Refer to Page 91 for Bulb Selection.

### FIG. 1303 - BULKHEAD LIGHT FIXTURES

**CONSTRUCTION OPTIONS:**

- \* BLACK MOLDED PLASTIC
- \* WHITE MOLDED PLASTIC
- \* BULB NOT INCLUDED

**FOR SYSTEMS UP TO 50 VOLTS**

**SIZE No. 1 HAS DOUBLE CONTACT BAYONET SOCKET  
WILL ACCOMMODATE A BULB UP TO 24 WATTS**

**SIZE No. 2 HAS MEDIUM SCREW SOCKET  
WILL ACCOMMODATE A BULB UP TO 40 WATTS**



**FIG. 1303 BLACK**



**FIG. 1303 WHITE**



### ORDERING INFORMATION

Dimensions Wall Plate Inches	Normal Projection Inches	Length Shade Inches	Black	White	Screw Size	Weight Ounces
			Std. Pkg. - 1 Pc. OEM Pkg. - 50 Pcs.	Std. Pkg. - 1 Pc. OEM Pkg. - 50 Pcs.		
4-1/2 x 3-1/4	4-3/8	3	1303 001 BLK	1303 001 WHT	8	3
4-1/2 x 3-1/4	5	4-1/2	1303 002 BLK	1303 002 WHT	8	5

Spare Switch, Cat. No. 701 DP.  
Refer to Page 91 for Bulb Selection.

LIGHTING FIXTURES, BULBS  
AND BATTERY SWITCHES

## U.S.C.G. ELECTRICAL STANDARDS

**ON JANUARY 31, 1977 THE U.S.C.G. PUBLISHED SAFETY STANDARDS FOR MARINE ELECTRICAL SYSTEMS. THESE STANDARDS COVER SUCH TECHNICAL DETAILS AS:**

- **BATTERIES AND ASSOCIATED CONDUCTORS**
- **CONDUCTOR SIZE AND AMPACITY**
- **STRAIN RELIEF AND PULL TESTS**
- **TERMINATION REQUIREMENTS**
- **OVERCURRENT PROTECTION**
- **IGNITION PROTECTION**
- **GROUNDING**
- **INSULATION**

A particular electrical component may be affected by some or all of the above categories. Those categories related to product design have been complied with, however, many additional details must be considered by the installer of the equipment as well in order to achieve compliance with this standard. It is suggested that the actual standard be familiarized when installing equipment. Perhaps one of the most critical requirements is ignition protection. A product that is marked "Ignition Protected" can be used in that area of a boat that is not isolated from a gasoline fuel vapor source. Refer to the actual standard for a determination of what parts of a boat require Ignition Protected products. If a product is not plainly marked "Ignition Protected" then assume it is not.

**FOR DETAILS ON ALL OF THE ABOVE, OBTAIN THE FOLLOWING:  
U.S.C.G. SAFETY STANDARDS FOR ELECTRICAL SYSTEMS  
CFR TITLE 33, CHAPTER 1, SUBCHAPTER S, PART 183, SUBPART I.**

## BATTERY SWITCHES

**BATTERY DISCONNECT SWITCHES HELP MANAGE THE OVERALL USE OF ELECTRICAL POWER ONBOARD. THEY ARE USED TO CONNECT OR DISCONNECT ELECTRICAL DEVICES FROM THE ELECTRICAL SYSTEM. THEY HELP TO PREVENT BATTERY DRAIN DURING PERIODS OF INACTIVITY. THEY ALLOW FOR A QUICK AND EASY WAY TO SHUT DOWN THE ENTIRE ELECTRICAL SYSTEM IN AN EMERGENCY. AN OPTIONAL KEY LOCK HELPS TO PREVENT UNAUTHORIZED USE OF THE VESSEL.**

**IN ADDITION TO DOING EVERYTHING A BATTERY DISCONNECT SWITCH DOES, BATTERY SELECTOR SWITCHES PERMIT BATTERY SELECTION (OF TWO OR MORE BATTERIES) FOR SPECIFIC PURPOSES INCLUDING STARTING ENGINES, RUNNING ACCESSORIES OR EVEN RECHARGING. THEY ALLOW FOR THE USE OF ONE OR MORE BATTERIES IN SYSTEMS WITH ONE OR MORE ENGINES AND FACILITATE PUTTING BATTERIES IN PARALLEL FOR EMERGENCY STARTING WHEN ONE OR BOTH BATTERIES ARE SUBSTANTIALLY DISCHARGED.**

**ALL PERKO BATTERY DISCONNECT SWITCHES AND BATTERY SELECTOR SWITCHES ARE UL LISTED, IGNITION PROTECTED AND CE APPROVED. THIS MEANS THEY HAVE BEEN TESTED AND CERTIFIED BY A RESPECTED OUTSIDE AGENCY, ARE DESIGNED TO BE USED SAFELY IN A BILGE WHERE EXPLOSIVE FUMES MAY BE PRESENT AND MEET ALL THE REQUIREMENTS FOR USE AND SALE THROUGHOUT THE WORLD.**

**PERKO BATTERY SWITCHES ARE DESIGNED FOR SURFACE MOUNTING. STANDARD DUTY SWITCHES HAVE A BRIGHT RED POLYCARBONATE HOUSING FOR SAFETY WITH A LARGE EASY TO TURN BLACK KNOB. THE HOUSING OF THE HEAVY DUTY SWITCHES ARE RED FIBER-REINFORCED POLYCARBONATE. SELECTOR SWITCHES ARE DESIGNED WITH A "MAKE BEFORE BREAK" FEATURE. THIS ALLOWS FOR SWITCHING BETWEEN THE "1", THE "ALL" AND THE "2" POSITIONS WHILE THE ENGINE IS RUNNING. MODELS WITH AN "ALTERNATOR FIELD DISCONNECT FEATURE" OFFER PROTECTION FOR NON-UNITIZED ALTERNATORS SHOULD THE SWITCH ACCIDENTLY BE TURNED TO THE "OFF" POSITION WITH THE ENGINE RUNNING.**

**Diagram #1**

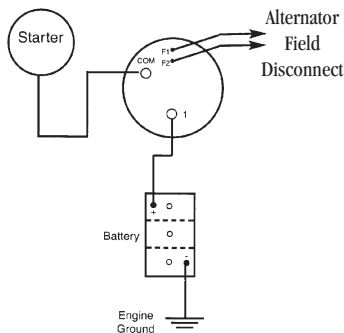

**SINGLE ENGINE - SINGLE BATTERY**

**Diagram #2**

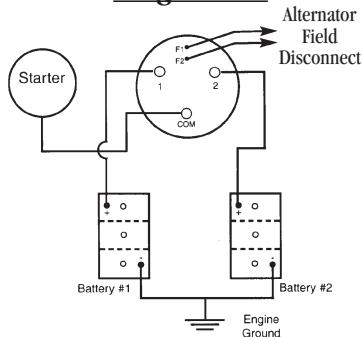

**SINGLE ENGINE - TWO BATTERIES**

Switch Position indicates which battery (#1, All, #2) is connected to engine.

**Diagram #3**

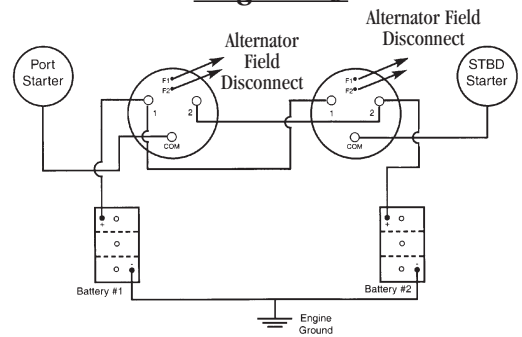

**2 SWITCHES, 2 ENGINES, 2 BATTERIES.**

This allows either engine to be started by either battery. Port switch indicates which battery (#1, All, #2) is connected to the port engine and the starboard switch indicates which battery (#1, All, #2) is connected to starboard Engine.

**Diagram #4**

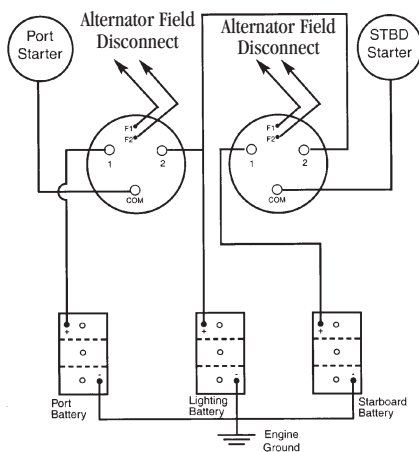

**2 SWITCHES, 2 ENGINES, 2 ENGINE BATTERIES AND SEPARATE BANK OF LIGHTING BATTERIES**

This allows both engines to be used to charge Lighting Batteries.

Port switch indicates which battery (port only, port lighting only) is connected to the port engine and the starboard switch indicates which battery (starboard only, starboard Lighting only) is connected to starboard engine.

### Optional Alternator Field Disconnect

- Use minimum 14 awg wire, suitable for use in marine engine compartments.
- On systems with separate regulator, splice the field disconnect switch into the field wire "F" as shown:

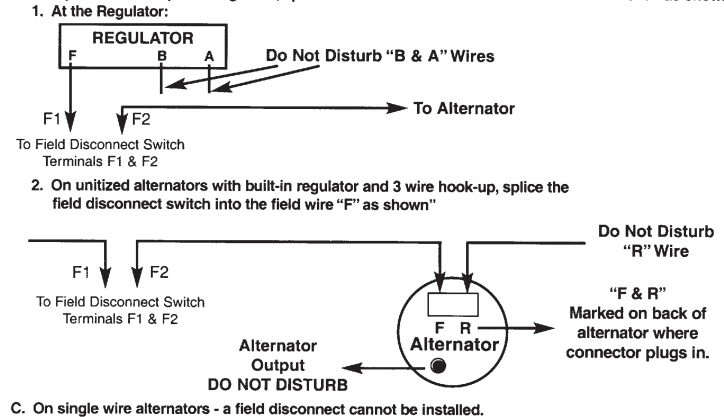

LIGHTING FIXTURES, BULBS AND BATTERY SWITCHES

## BATTERY SELECTOR SWITCHES

### IGNITION PROTECTED

PROTECTED BY THE FOLLOWING U.S. PATENTS; DESIGN 260,637 - 4,280,028 - 4,424,424



FOR USE WITH SYSTEMS UNDER 50 VOLTS  
CAPACITY - 250 AMPS CONTINUOUS, 360 AMPS INTERMITTENT

### FIGS. 8501/8502 - BATTERY SELECTOR SWITCHES



**Fig. 8501**

For Dual Engine Systems,  
two switches are required.



**Fig. 8502**

### FIGS. 8503/8504 - ALTERNATOR FIELD DISCONNECT MODELS



**Fig. 8503**

When used with  
Non-Unitized Alternators,  
these models will interrupt  
the field current  
(reducing the possibility of  
damage) if turned "OFF" with  
the engine running.



**Fig. 8504**



### ORDERING INFORMATION

	Dealer Pkg. - 5 Pkgs. 1 Pc. per Pkg.	OEM Bulk Pkg. 25 Pcs.	Diameter Inches	Depth Inches	Weight Pounds	Alternator Field Disconnect
Standard	8501 DP	8501	5-1/4	2-5/8	1	No
With Keylock	8502 DP	8502	5-1/4	2-5/8	1	No
Standard	8503 DP	8503	5-1/4	2-5/8	1	Yes
With Keylock	8504 DP	8504	5-1/4	2-5/8	1	Yes



**Fig. 8603**

### FIG. 8603 - HEAVY DUTY BATTERY SELECTOR SWITCH

FOR USE WITH SYSTEMS UNDER 50 VOLTS  
CAPACITY - RATED 380 AMPS CONTINUOUS,  
850 AMPS INTERMITTENT (5 MINUTES ON, 5 MINUTES OFF)



### ORDERING INFORMATION

Dimensions Face Inches	Depth Inches	Dealer Pkg. - 2 Pkgs. 1 Pc. per Pkg.	Weight Pounds
5-1/4 x 5-1/4	3-3/8	8603 DP	3

LIGHTING FIXTURES, BULBS  
AND BATTERY SWITCHES

## MAIN BATTERY DISCONNECT SWITCHES



### IGNITION PROTECTED

PROTECTED BY THE FOLLOWING U.S. PATENTS; DESIGN 260,637 - 4,280,028 - 4,424,424



FOR USE WITH SYSTEMS UNDER 50 VOLTS  
CAPACITY - 250 AMPS CONTINUOUS, 360 AMPS INTERMITTENT

### FIGS. 9601/9602 - MAIN BATTERY DISCONNECT SWITCHES



FIG. 9601



FIG. 9602

### FIGS. 9603/9604 - ALTERNATOR FIELD DISCONNECT MODELS



FIG. 9603

When used with Non-Utilized Alternators, these models will interrupt the field current (reducing the possibility of damage) if turned "OFF" with the engine running.



FIG. 9604



### ORDERING INFORMATION

Features:	Dealer Pkg. - 5 Pkgs. 1 Pc. per Pkg.	OEM Bulk Pkg. 25 Pcs.	Diameter Inches	Depth Inches	Weight Pounds	Alternator Field Disconnect
Standard	9601 DP	9601	5-1/4	2-5/8	1	No
With Keylock	9602 DP	9602	5-1/4	2-5/8	1	No
Standard	9603 DP	9603	5-1/4	2-5/8	1	Yes
With Keylock	9604 DP	9604	5-1/4	2-5/8	1	Yes

### FIG. 9703 - HEAVY DUTY BATTERY DISCONNECT SWITCH

FOR USE WITH SYSTEMS UNDER 50 VOLTS.

CAPACITY - RATED 450 AMPS CONTINUOUS,  
1200 AMPS INTERMITTENT (15 SECONDS ON, 5 MINUTES OFF).



### ORDERING INFORMATION

Dimensions	Depth	Dealer Pkg. - 2 Pkgs. 1 Pc. per Pkg.	Weight Pounds
Face Inches	Inches	9703 DP	3-1/4
5-1/4 x 5-1/4	3-3/8		



FIG. 9703

## SWITCHES & SWITCH PANEL

**FIG. 517 - SWITCH PANEL**

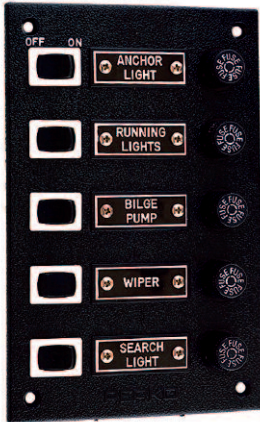

**FIG. 517**

**CONSTRUCTION:**

- \* **BLACK PLASTIC TEXTURED FINISH**
- \* **ENGRAVED LETTERING**
- \* **RATED FOR 10 AMPS AT 12, 24 AND 32 VOLTS**
- \* **ROCKER SWITCHES, NAME PLATES AND LOW PROFILE FUSE HOLDERS FOR 1/4" x 1-1/4" FUSES INCLUDED**
- \* **WILL MOUNT ON CURVED OR FLAT SURFACES**



**ORDERING INFORMATION**

Dimensions Inches	Dealer Pkg. - 5 Cards 1 Pc. per Card	Weight Ounces
6-1/2 x 4-1/2	517 DP BLK	8

Screw Size #6

Spare Fuse Holders, Cat. No. 532 DP.

Spare Rocker Switches, Cat. No. 531DP.

Spare Fuse Holder Cap, Cat. No. 558 DP.

**FIG. 701 - PUSH BUTTON SWITCH**



**FIG. 701**

**CONSTRUCTION:**

- \* **BLACK PLASTIC WITH WEATHER RESISTANT COVER**
- \* **PUSH-ON, PUSH-OFF**
- \* **RATED FOR 10 AMPS AT 12, 24 AND 32 VOLTS**



**ORDERING INFORMATION**

Maximum Thickness of Panel Inches	Diameter Neck Inches	Dealer Pkg. - 10 Cards 1 Pc. per Card	Weight Ounces
1/8	3/8	701 DP	1/2



**FIG. 514/688 - TOGGLE SWITCHES**



**FIG. 514**

**CONSTRUCTION:**

- \* **NICKEL PLATED BRASS TOGGLE WITH CHROME PLATED FACE NUT**
- \* **SINGLE POLE, SINGLE THROW (OFF-ON)**
- FIG. 514 RATED FOR 6 AMPS AT 12, 24 AND 32 VOLTS**
- FIG. 688 RATED FOR 20 AMPS AT 12, 24 AND 32 VOLTS**



**ORDERING INFORMATION**

Maximum Thickness of Panel Inches	Diameter Neck Inches	Dealer Pkg. - 10 Cards 1 Pc. per Card	Weight Ounces
5/16 3/16	7/16 7/16	514 DP 688 DP NKL	3/4 1



**FIG. 688**

**Important Note: None of the above Switches are Ignition Protected. See Page 84.**

LIGHTING FIXTURES, BULBS AND BATTERY SWITCHES



## IN-LINE FUSE HOLDER, CONNECTIONS & CABLE OUTLET

**FIG. 786 - IN-LINE FUSEHOLDER**

**CONSTRUCTION:**

- \* **MOLDED PLASTIC**
- \* **RATED FOR 20 AMPS AT 12, 24 AND 32 VOLTS FOR 1/4" X 1-1/4" FUSES**
- \* **12 VOLT, 20 AMP FUSE AND 7-1/2 INCH WIRE LEAD INCLUDED**



**FIG. 786**



**ORDERING INFORMATION**

Length Inches	Diameter Inches	Dealer Pkg. - 10 Cards 1 Pc. per Card	Weight Ounces
2-1/8	11/16	786 DP	3/4



**FIGS. 1189 & 1190 - WATERTIGHT DECK CONNECTIONS**

**CONSTRUCTION:**

**FIG. 1189 - CHROME PLATED BRASS**  
**FIG. 1190 - CHROME PLATED ZINC ALLOY**

- \* **RATED FOR 15 AMPS AT 12, 24 AND 32 VOLTS POLARIZED DOUBLE CONTACT CONNECTOR**
- \* **FLANGE GASKET WITH INTEGRAL WATERPROOF CAP FOR BASE WHEN PLUG IS REMOVED**



**ORDERING INFORMATION**

Diameter Inches	Height Inches	Dealer Pkg. - 10 Cards 1 Pc. per Card	OEM Bulk Pkg. 50 Pcs.	Screw Size	Weight Ounces
1-5/8	1-3/16	1189 DP CHR	1189 000 CHR	6	2-1/2
1-5/8	1-3/16	1190 DP CHR	1190 000 CHR	6	2-1/2

Spare Connector with Cover, Cat. No. 1189 DP 99A.

Spare Connector Only, Cat. No. 42.

**Note: These Items Are Not Ignition Protected.**



**FIG. 1189**

**CHROME PLATED BRASS**

**FIG. 1190**

**CHROME PLATED ZINC**

**Important Note: All of the Above Items Conform to U.S.C.G. Electrical Standards. See Page 84.**

**FIGS. 424 & 1191 - WATERTIGHT CABLE OUTLETS**

**CONSTRUCTION:**

**FIG. 424, CHROME PLATED BRASS**  
**FIG. 1191, CHROME PLATED ZINC ALLOY**

- \* **FOR 5/16 INCH O.D. CABLE**
- \* **EQUIPPED WITH RUBBER GROMMET FOR WATERTIGHT PASSAGE OF CABLE**



**ORDERING INFORMATION**

Diameter Base Inches	Dealer Pkg. - 10 Cards 1 Pc. per Card	Screw Size	Weight Ounces
1-1/4	424 DP CHR	6	1
1-1/4	1191 DP CHR	6	1



**FIG. 424 - CHROME PLATED BRASS**

**FIG. 1191 - CHROME PLATED ZINC**

## CABLE STRAPS & LINE SUPPORT CLIPS

**FIG. 196 - PLASTIC CABLE STRAP**

**CONSTRUCTION:**

- \* **BLACK PLASTIC**
- \* **ULTRA-VIOLET STABILIZED FOR WEATHER RESISTANCE**
- \* **ELIMINATES THE NEED FOR INSULATING CUSHION**



**FIG. 196**



**ORDERING INFORMATION**

I.D. Inches	Dealer Pkg. - 10 Cards 10 Pcs. per Card	OEM Pkg. 500 Pcs.
3/16	196 DP1	196 001
1/4	196 DP2	196 002
5/16	196 DP3	196 003
3/8	196 DP4	196 004
1/2	196 DP5	196 005
5/8	196 DP6	196 006
3/4	196 DP7	196 007

Width all sizes - 1/2 inch.

**Note: This Item Conforms to U.S.C.G. Electric Standards**



**FIGS. 163, 164, 165 - LINE SUPPORT CLIPS**

**CONSTRUCTION:**

- \* **ALUMINUM WITH SYNTHETIC RUBBER CUSHION**



**FIG. 163  
SINGLE**



**FIG. 164  
DOUBLE**



**FIG. 165  
TRIPLE**



**ORDERING INFORMATION**

For O.D. Line Inches	Width Inches	Single Dealer Pkg. - 10 Cards 10 Pcs. per Card	Double Dealer Pkg. - 10 Cards 10 Pcs. per Card	Triple Dealer Pkg. - 10 Cards 10 Pcs. per Card
3/16	3/8	163 DP1 ALU	164 DP1 ALU	-----
1/4	3/8	163 DP2 ALU	164 DP2 ALU	-----
5/16	1/2	163 DP3 ALU*	164 DP3 ALU	165 DP3 ALU
3/8	1/2	163 DP4 ALU*	164 DP4 ALU	165 DP4 ALU
1/2	1/2	163 DP5 ALU	164 DP5 ALU*	165 DP5 ALU*
5/8	1/2	163 DP6 ALU*	-----	-----

\*OEM Package - 500 Pcs. Replace "DP" with "00" When Ordering.

**Note: This Item Conforms to U.S.C.G. Electric & Fuel Standards**



LIGHTING FIXTURES, BULBS AND BATTERY SWITCHES

## SPARE BULBS FOR UTILITY LIGHTS

**FIG. 432 - SEALED BEAM UNITS**

**ORDERING INFORMATION**

Nominal Voltage	Wattage	Amps	Standard Pkg. 5 Pieces	Bulbs per Pkg.	Bulb Length Inches	Mfg. Lamp No.
12	35	3	432 001 12V	1	2-3/4	4406
24	50	2	432 002 24V	1	2-3/4	4593
32	60	2	432 003 32V	1	2-3/4	4350

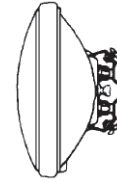

**FIG. 432**

**FIG. 337 - DOUBLE CONTACT BAYONET BASE BULB**

**CLEAR**



**ORDERING INFORMATION**

Nominal Voltage	Wattage	Amps	Dealer Pkg. 5 Cards	Bulbs per Card	Bulb Diameter Inches	Mfg. Lamp No.
12	7	.58	337 011 DP	2	3/4	90
12	11	.94	337 012 DP	2	3/4	1004
12	17	1.44	337 013 DP	2	1	1142
24	15	.63	337 014 DP	1	1	306
32	13	.40	337 018 DP	1	3/4	624
32	14	.43	337 019 DP	1	1	1228
32	21	.66	337 020 DP	1	1	1692
32	24	.74	337 021 DP	1	1-3/8	1054
120	15	---	337 023 DP	2	7/8	15T7

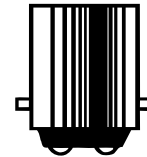

**FIG. 337**



**FIG. 67 & 70 - DOUBLE ENDED FESTOON BULBS**

**CLEAR**

**NICKEL PLATED BRASS CAPS**



**ORDERING INFORMATION**

Nominal Voltage	Wattage	Amps	Dealer Pkg. - 5 Cards 2 Bulbs per Card	Bulb Diameter Inches	Bulb Length Inches
12	10	.74	70 DP0 CLR	3/8	1-11/16
12	15	.97	70 DP1 CLR	9/16	1-11/16
24	10	.42	67 DP1 CLR	3/8	1-11/16

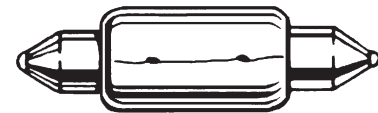

**FIG. 70**



**FIG. 340 - MEDIUM SCREW BASE BULB**



**ORDERING INFORMATION**

Nominal Voltage	Wattage	Amps	Standard Pkg. 6 Bulbs	Type	L.C.L. Inches	Mfg. Lamp No.
12	15	1.25	340 005 FRD	A-17	2-3/8	15-A
12	25	2.08	340 006 FRD	A-19	2-9/16	25-A
12	50	4.16	340 007 FRD	A-21	3-7/16	50-A21
32	15	.47	340 011 FRD	A-17	2-3/8	15-A
32	25	.78	*340 012 FRD	A-19	2-9/16	25-A
32	50	1.56	*340 013 FRD	A-21	3-7/16	50-A21



**FIG. 340**



\*Standard Pkg. - 2 Bulbs

**Note: High Power Bulbs and Sealed Beam Units for Searchlights, See Searchlight Section.**

**ELECTRIC BULBS ARE NOT RETURNABLE. ORDER CAREFULLY.**

Note: Figs. 162 & 349 Conform to A.B.Y.C. Standard A-23 in Accordance with the '72 COLREGS and U.S. Inland Rules for Use on Vessels Under 5 Meters (16.4 ft.) in Length.



**FIG. 162**

### FIG. 162 - FOG HORN

#### CONSTRUCTION:

- \* ALUMINUM WITH WHITE BAKED ENAMEL FINISH
- \* NYLON MOUTHPIECE



#### ORDERING INFORMATION

Length Inches	Dealer Pkg. - 10 Bags 1 Pc. per Bag	Weight Ounces
12-1/2	162 DP WHT	6

### FIG. 349 - "BALL TYPE" WHISTLE

#### CONSTRUCTION:

- \* ORANGE PLASTIC



#### ORDERING INFORMATION

Length Inches	Width Inches	Dealer Pkg. - 10 Cards 1 Pc. per Card	OEM Bulk Pkg. 100 Pcs.	Weight Ounces
2-1/4	3/4	349 DP	349	1-1/2



**FIG. 349**

### FIG. 441 - PORTLIGHT CHAIN

#### CONSTRUCTION:

- \* STAINLESS STEEL CHAIN WITH CHROME PLATED FITTINGS



#### ORDERING INFORMATION

Length Inches	Length Strap Inches	Dealer Pkg. - 5 Cards 1 Pc. per Card	OEM Bulk Pkg. 50 Pcs.	Screw Size	Weight Ounces
7	1-7/8	441 DP CHR	441 000 CHR	8	2



**FIG. 441**

### FIG. 461 - PORTLIGHT WEATHERSTRIPPING

#### CONSTRUCTION:

- \* OPEN CELL FOAM RUBBER
- \* SUPPLIED IN TEN FOOT LENGTHS



#### ORDERING INFORMATION

Height Inches	Min. Width Inches	Max. Width Inches	Standard Pkg. - 1 Length
3/8	1/4	7/16	461

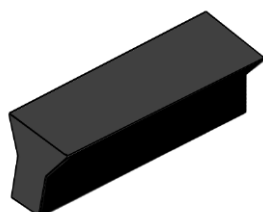

**FIG. 461**

### FIG. 708 - YACHT LOG BOOK

120 PAGES 8-1/4" X 11"

Log Book includes expanded Vessel and Equipment Information listings, weather symbols and a modified Beaufort wind scale, VHF radio channel assignments & marine radio procedures, marine radio log, most frequently used courses, repair & maintenance logs, and expense journal, GPS/Loran waypoint log, expanded cruising log, a diary & notes section and a friends & guest log and cover is hard bound with a water resistant washable finish. Navy blue with gold lettering.



#### ORDERING INFORMATION

Dealer Pkg. - 5 Bags 1 Pc. per Bag	Weight Ounces
708 DP	18



**FIG. 708**

## COWL & CLAM SHELL VENTILATORS

**FIG. 1312 - COWL VENTILATOR**

**CHROME PLATED ZINC ALLOY COWL WITH BLACK PLASTIC BASE**  
**3" DUCT THREADS INTO NECK, HOSE CLAMPS NOT REQUIRED**



**ORDERING INFORMATION**

Opening Square Inches	Length Overall Inches	Width Overall Inches	Height Overall Inches	Dealer Pkg. 5 Cards 1 Pc. per Card	OEM Bulk Pkg. 50 Pcs.	Screw Size	Weight Ounces
8	5-3/4	4-3/8	2-5/8	1312 DP CHR	1312 000 CHR	8	12



**FIG. 1312**

**FIG. 870 - COWL VENTILATOR**

**CHROME PLATED ZINC ALLOY COWL WITH BLACK PERKO•KOTE BASE**  
**3" DUCT THREADS INTO NECK, HOSE CLAMPS NOT REQUIRED**



**ORDERING INFORMATION**

Mouth Opening Square Inches	Length Overall Inches	Width Overall Inches	Height Overall Inches	Dealer Pkg. 1 Pc	OEM Bulk Pkg. 5 Pcs.	Screw Size	Weight Ounces
7-1/3	5-1/8	4	3-7/8	870 DP CHR	870 000 CHR	10	21



**FIG. 870**

**FIG. 510 - COWL VENTILATOR**

**POLISHED OR CHROME PLATED BRASS, CAST BRONZE DECK PLATE**  
**Internal Thumb Screw Allows Cowl to be Locked in any Position**  
**Ventilators are Painted White Inside Only**

**ORDERING INFORMATION**

I.D. Deck Plate Inches	O.D. Deck Plate Inches	Diameter Mouth Inches	Height Overall Inches	Polished Brass Standard Pkg. - 1 Pc.	Chrome Plated Brass Standard Pkg. - 1 Pc.	Screw Size	Weight Pounds
4	7-1/16	8	11	510 004 POL	510 004 CHR	10	6-3/8



**FIG. 510**

For Spare Deck Plates, Covers and Keys; Refer to Fig. No. 526, Page 113.

**FIG. 315 - CLAM SHELL VENTILATOR**

**CHROME PLATED BRASS**



**ORDERING INFORMATION**

Dimensions Base Inches	Height Opening Inches	Width Opening Inches	Dealer Pkg. 10 Cards 1 Pc. per Card	OEM Bulk Pkg. 100 Pcs.	Screw Size	Weight Ounces
1-5/8 x 1-1/2	7/16	7/8	315 DP1 CHR	315 001 CHR	4	1/2
2 x 2	9/16	1-7/8	315 DP2 CHR	315 002 CHR	6	1-1/4



**FIG. 315**

**FIG. 339 - CLAM SHELL VENTILATOR**

**CHROME PLATED BRASS**



**ORDERING INFORMATION**

Dimensions Base Inches	Height Opening Inches	Width Opening Inches	Dealer Pkg. 5 Cards 1 Pc. per Card	OEM Bulk Pkg. 25 Pcs.	Screw Size	Weight Ounces
4 x 3-3/4	1-5/8	2-1/2	339 DP CHR	339 000 CHR	6	5-1/2



**FIG. 339**

## VENTILATORS

**FIG. 707 - VENTILATOR**



**Fig. 707**

**CONSTRUCTION:**

\* **CHROME PLATED BRASS FRAME & SCREEN**



**ORDERING INFORMATION**

Dimensions Inches	Dealer Pkg. - 10 Cards 1 Pc. per Card	OEM Bulk Pkg. 25 Pcs.	Screw Size	Weight Ounces
7-1/4 x 1-1/2	707 DP CHR	707 000 CHR	8	2

**FIG. 330 - LOCKER VENTILATOR**

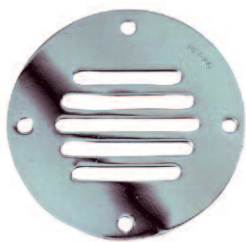

**Fig. 330**

**CONSTRUCTION:**

\* **CHROME PLATED BRASS**



**ORDERING INFORMATION**

O.D. Inches	Dealer Pkg. - 10 Cards 1 Pc. per Card	OEM Bulk Pkg. 100 Pcs.	Screw Size	Weight Ounces
2-1/2	330 DP1 CHR	330 001 CHR	6 R.H.	3/4
3-1/4	330 DP2 CHR	330 002 CHR	6 R.H.	1

**FIG. 550 - TRANSOM OR LOCKER VENTILATOR**



**Fig. 550**

**CONSTRUCTION:**

\* **CHROME PLATED BRASS**



**ORDERING INFORMATION**

Dimensions Inches	Dealer Pkg. - 10 Cards 1 Pc. per Card	OEM Bulk Pkg. 25 Pcs.	Screw Size	Weight Ounces
7 x 2-1/2	550 DP CHR	550 000 CHR	8	3

**FIG. 1271 - TRANSOM OR LOCKER VENTILATOR**



**Fig. 1271**

**CONSTRUCTION:**

\* **CHROME PLATED ZINC ALLOY**

\* **ANODIZED ALUMINUM EXPANDED MESH SCREEN**



**ORDERING INFORMATION**

Dimensions Inches	Dealer Pkg. - 10 Cards 1 Pc. per Card	OEM Bulk Pkg. 25 Pcs.	Screw Size	Weight Ounces
6 x 2	1271 DP CHR	1271 000 CHR	8	3

**FIG. 1238 - TRANSOM OR LOCKER VENTILATOR**



**Fig. 1238**

**CONSTRUCTION:**

\* **CHROME PLATED ZINC ALLOY**

\* **ANODIZED ALUMINUM GRILL-TYPE SCREEN**



**ORDERING INFORMATION**

Dimensions Inches	Dealer Pkg. - 10 Cards 1 Pc. per Card	OEM Bulk Pkg. 50 Pcs.	Screw Size	Weight Ounces
8-3/8 x 2-1/4	1238 DP CHR	1238 000 CHR	8	4

## VENTILATORS

**FIG. 334 - LOUVER VENTILATOR**

**CONSTRUCTION:**

**\* CHROME PLATED BRASS**



**ORDERING INFORMATION**

Dimensions Inches	Length Louvers Inches	Dealer Pkg. - 5 Cards 1 Pc. per Card	OEM Bulk Pkg. 10 Pcs.	Weight Ounces
3 x 2-1/2	2	334 002 DP	334 002 CHR	1-1/5
4 x 2-1/2	3	334 02A DP	334 02A CHR	1-4/5
5-1/2 x 2-1/2	2	334 004 DP	334 004 CHR	2-1/2
7-1/2 x 2-1/2	3	334 04A DP	334 04A CHR	3-1/5
8 x 2-1/2	2	334 006 DP	334 006 CHR	3-1/2
11 x 2-1/2	3	334 06A DP	334 06A CHR	4-1/2

Screw Size #4 R.H.

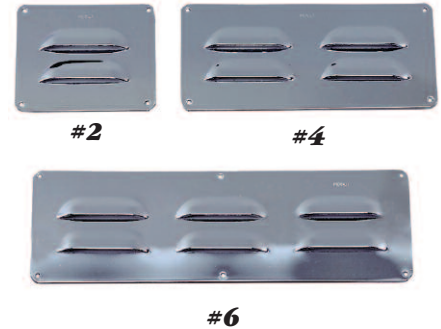

**FIG. 334**

**FIG. 335 - LOUVER VENTILATOR**

**CONSTRUCTION:**

**\* CHROME PLATED BRASS**



**ORDERING INFORMATION**

Dimensions Inches	Length Louvers Inches	Dealer Pkg. - 5 Cards 1 Pc. per Card	OEM Bulk Pkg. 10 Pcs.	Weight Ounces
3 x 3	2	335 003 DP	335 003 CHR	1-1/2
4 x 3-1/2	3	335 03A DP	335 03A CHR	2
5-1/2 x 3	2	335 006 DP	335 006 CHR	3
7-1/2 x 3-1/2	3	335 06A DP	335 06A CHR	4-1/2
8 x 3	2	335 009 DP	335 009 CHR	4
11 x 3-1/2	3	335 09A DP	335 09A CHR	6-1/2

Screw Size #4 R.H.

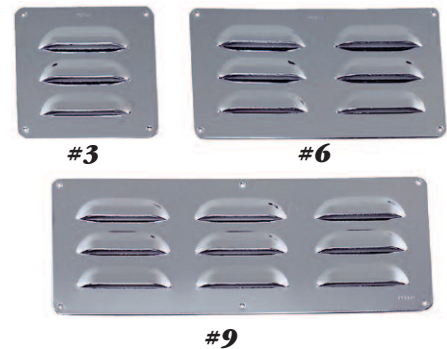

**FIG. 335**

**FIG. 336 - LOUVER VENTILATOR**

**CONSTRUCTION:**

**\* CHROME PLATED BRASS**



**ORDERING INFORMATION**

Dimensions Inches	Length Louvers Inches	Dealer Pkg. - 5 Cards 1 Pc. per Card	OEM Bulk Pkg. 10 Pcs.	Weight Ounces
3-3/4 x 3	2	336 004 DP	336 004 CHR	2
4-3/8 x 4	3	336 04A DP	336 04A CHR	3
4-1/2 x 3	2	336 005 DP	336 005 CHR	2-1/2
5-3/8 x 4	3	336 05A DP	336 05A CHR	3-4/5
5-1/4 x 3	2	336 006 DP	336 006 CHR	2-4/5
6-3/8 x 4	3	336 06A DP	336 06A CHR	4-1/3

Screw Size #4 R.H.



**FIG. 336**

## FOG BELLS

**THE 8 AND 12 INCH BELLS LISTED ON THIS PAGE HAVE BEEN REVIEWED BY THE U.S. COAST GUARD AND COMPLY WITH C.G. 169 REGULATIONS FOR SOUND SIGNAL APPLIANCES AS REQUIRED BY ANNEX III PARAGRAPH 2 OF THE '72 COLREGS. THE 8 INCH SIZE IS FOR USE ON VESSELS UNDER 20 METERS (65.6 FT.) IN LENGTH. THE 12 INCH SIZE IS FOR USE ON VESSELS OF ANY LENGTH.**

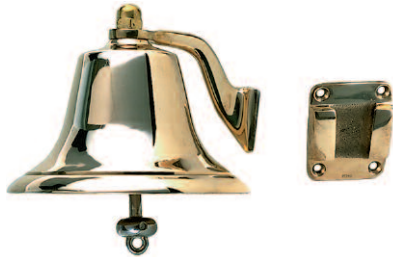

**FIG. 420 POLISHED**



**FIG. 420 CHROME**

**FIG. 420 - FOG BELL**

**CONSTRUCTION OPTIONS:**

- \* **POLISHED CAST BRONZE**
- \* **CHROME PLATED CAST BRONZE**
- \* **MEDIUM WEIGHT**
- \* **REMOVABLE**

**ORDERING INFORMATION**

Bottom Diameter Inches	Height Overall Inches	Polished Bronze Std. Pkg. - 1 Pc.	Chrome Plated Bronze Std. Pkg. - 1 Pc.	Weight Pounds
6	5	420 006 POL	420 006 CHR	4-1/4
8	6-1/8	420 008 POL	420 008 CHR	7-1/8

Screw Size #8 F.H.

**FIG. 150 - FOG BELL**



**FIG. 150**

**CONSTRUCTION OPTIONS:**

- \* **CAST BRONZE**
- \* **CHROME PLATED, PLAIN OR POLISHED**
- \* **HEAVY WEIGHT**
- \* **REMOVABLE**

**ORDERING INFORMATION**

Bottom Diameter Inches	Height Overall Inches	Plain Bronze Std. Pkg. - 1 Pc.	Polished Bronze Std. Pkg. - 1 Pc.	Chrome Plated Bronze Std. Pkg. - 1 Pc.	Weight Pounds
8	8	150 008 PLB	150 008 POL	150 008 CHR	11
12	12	150 012 PLB	150 012 POL	150 012 CHR	28-1/4

Screw Size 1/4" F.H.

**SPARE PARTS ORDERING INFORMATION FOR PAGES 96 AND 97**

For complete Spare Part No. Insert Finish Code:

P or PLB, for Plain Bronze or Brass Finish (i.e. 420 P06 99A or 127 000 PLB).  
 B or POL, for Polished Bronze or Brass Finish (i.e. 420 B06 99A or 127 000 POL).  
 C or CHR, for Chrome Plated Finish (i.e. 420 C06 99A or 127 000 CHR).

ARMS		WALL PLATES		CLAPPERS		EYE BOLTS		ACORN NUTS	
Figure No.	Spare Part No.	Figure No.	Spare Part No.	Figure No.	Spare Part No.	Figure No.	Spare Part No.	Figure No.	Spare Part No.
420-6"	420-99A-6"	420-6"	127	420-6"	153	420-6"	113	420-6"	465 004
420-8"	171	420-8"	127	420-8"	144	420-8"	123	420-8"	465 008
150-8"	171	150-8"	127	150-8"	144	150-8"	123	150-8"	465 008
150-12"	150-99A-12"	150-12"	150-99B-12"	150-12"	172	150-12"	172	150-12"	465 009
*158-12"	158-99A-12"	*158-12"	158-99A-12"	*158-12"	172	*158-12"	172	158-12"	465 009
179	179-000-99A	179	179-000-99A	179	144	179	179-99B	179	465 008
159-6"	159-99A	159-6"	166	159-6"	159-99B	159-6"	113	159-6"	465 004
159-8"	159-99A	159-8"	166	159-8"	153	159-8"	113	159-8"	465 004

\*Includes Wall Bracket

\*Includes Arm

\*Includes Eye Bolt

\*Includes Clapper



## FOG BELLS

**THE 8 AND 12 INCH BELLS LISTED ON THIS PAGE HAVE BEEN REVIEWED BY THE U.S. COAST GUARD AND COMPLY WITH C.G. 169 REGULATIONS FOR SOUND SIGNAL APPLIANCES AS REQUIRED BY ANNEX III PARAGRAPH 2 OF THE '72 COLREGS. THE 8 INCH SIZE IS FOR USE ON VESSELS UNDER 20 METERS (65.6 FT.) IN LENGTH. THE 12 INCH SIZE IS FOR USE ON VESSELS OF ANY LENGTH.**

**FIG. 158 - FOG BELL**

- CONSTRUCTION OPTIONS:**
- \* **PLAIN, POLISHED OR CHROME PLATED CAST BRONZE**
  - \* **HEAVY WEIGHT**
  - \* **FIXED MOUNTING**



**FIG. 158 POLISHED**

**ORDERING INFORMATION**

Bottom Diameter Inches	Height Overall Inches	Plain Bronze Std. - 1 pc.	Polished Bronze Std. Pkg. - 1 Pc.	Chrome Plated Bronze Std. Pkg. - 1 Pc.	Weight Pounds
12	12	158 012 PLB	158 012 POL	158 012 CHR	29-2/3

Screw Size 1/4" R.H.

**FIG. 179 - FOG BELL**

**CONSTRUCTION OPTIONS:**

- \* **WROUGHT BRASS**
- \* **PLAIN BRASS FINISH**
- \* **LIGHT WEIGHT**
- \* **FIXED MOUNTING**



**FIG. 179**

**ORDERING INFORMATION**

Bottom Diameter Inches	Height Overall Inches	Standard Pkg. - 1 Pc.	Weight Pounds
12	8	179 012 PLB	7-3/4

Screw Size #12 R.H.

**FIG. 159 - FOG BELL**

**CONSTRUCTION OPTIONS:**

- \* **STAMPED BRASS**
- \* **PLAIN OR CHROME PLATED BRASS FINISH**
- \* **LIGHT WEIGHT**
- \* **REMOVABLE**



**FIG. 159 CHROME**



**ORDERING INFORMATION**

Bottom Diameter Inches	Height Overall Inches	Chrome Plated Dealer Pkg. - 2 Pcs. 1 Pc. per Pkg.	Plain Brass Dealer Pkg. - 2 Pcs. 1 Pc. per Pkg.	Weight Pounds
6	4	159 DP6 CHR	159 DP6 PLB	1-1/2
8	5	159 DP8 CHR	159 DP8 PLB	2-3/4

Screw Size #4 F.H.

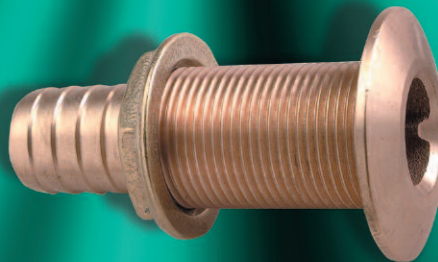
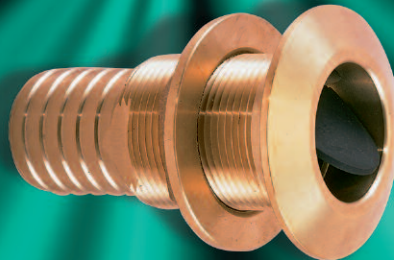
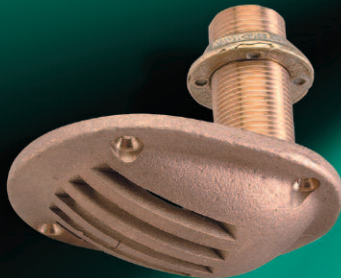
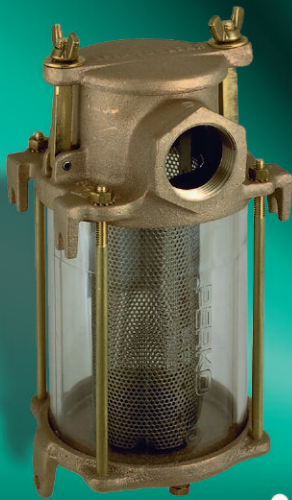

**FIG. 159 PLAIN**

# QUALITY, RELIABILITY & SATISFACTION

## Underwater Marine Hardware

- *Water Strainers*
- *Thru-Hull Fittings*
- *Scuppers*
- *Seacocks*
- *Strainers*
- *Pipe to Hose Adapters*



UNDERWATER HOME, DECK  
PLATES, FILLS & VENTS

## UNDERWATER HARDWARE PACKAGING

We made changes in our Underwater Hardware Packaging this year. Our “DP” Dealer Package for small items (like the smaller thru hull fittings and tailpieces) will be a 5 or 10 piece bulk box with a bar code label on each individual unit. **THESE 10 PIECE CARTONS CANNOT BE BROKEN.** Larger items (like valves & strainers) will be available individually boxed as a single unit standard package with a bar code label on the outside of the box.

*To be sure the parts you receive are bar coded for Retail Sale, order either a “DP” version or a single unit standard package.*



All of our small repair/replacement strainer parts are now bar coded. Top Castings (99A), Bottom Castings (99B), Transparent Cylinders (99C), Strainer Baskets (99D) and Covers (99E) are available individually boxed as bar coded single unit standard packages. Smaller items or kits including Cover Hardware Kits (99L), Gasket Kits (99M & 99R) and Tie Rod Kits (99P) are individually packaged as “DP” items in bags with a bar code label.

### INTAKE WATER STRAINER SPARE PARTS ORDERING INFORMATION

For Spare Part No. Insert a Spare Part Code Listed Below in Place of the “PLB” in the Strainer’s Catalog Number (i.e., 493 006 99A, Top Casting for 1” Strainer).

Description	Spare Part Code	Sample Part Number	Package	Description	Spare Part Code	Sample Part Number	Package
Top Casting . . . . .	99A	493 004 99A	Boxed	<b>Cork Gasket Kit</b> Consists of: 1- Cover Gasket and 2- Cork Cylinder Gaskets . . . . . 99M*	493 DP5 99M	Bag	
Bottom Casting . . . . .	99B	493 004 99B	Boxed				
Transparent Cylinder . . . . .	99C	493 004 99C	Boxed	<b>Rubber Gasket Kit</b> Consists of: 1- Cover Gasket and 2- Rubber Cylinder Gaskets . . . 99R*	493 DP5 99R	Bag	
Basket Strainer . . . . .	99D	493 004 99D	Boxed				
Cover with Gasket . . . . .	99E	493 004 99E	Boxed	<b>Tie Rods, Nuts and Washers</b> Consists of (4 Each for 493 Series) (1 Each for 500 Series). . . . . 99P	493 DP4 99P	Bag	
Hinged Bolt for Cover With Pin, Nut and Washer . . . . .	99L	493 DP5 99L	Bag				

\*Note Older Model strainers utilizing cork cylinder gaskets must order 99M - Cork Gasket Kit, and newer model strainers must order 99R- Rubber Gasket Kit

UNDERWATER HDWE, DECK PLATES, FILLS & VENTS

## INTAKE WATER STRAINERS

**FIGS. 493 & 500 - INTAKE WATER STRAINERS**

**CONSTRUCTION:**

**\* CAST BRONZE**

**PERKO WATER STRAINERS ARE DESIGNED FOR EASY INSTALLATION AND CLEANING. FEATURES INCLUDE MOUNTING LUGS CAST INTO BOTH SIDES TO ASSURE UNIVERSAL MOUNTING, FOUR OUTSIDE TIE RODS AND A 304 STAINLESS STEEL STRAINER BASKET TO MINIMIZE ELECTROLYSIS. SCREEN HOLE SIZE DIAMETER .077 INCHES, 46% OPEN AREA. HINGED LUGS FOR THE CAST BRONZE COVER PERMIT EASY REMOVAL AND CLEANING OF THE STRAINER BASKET. A DRAIN PLUG IN THE BOTTOM CASTING IS PROVIDED FOR EASILY REMOVING SEDIMENT AND DRAINING FOR WINTERIZING.**

**FOR APPLICATIONS REQUIRING HIGHER CAPACITY SEE FIG. 500 BELOW**



**Fig. 493**



**Fig. 500**



**ORDERING INFORMATION FOR FIG. 493**

Pipe Size	Height Overall	Width Overall	Standard Pkg. - 1 Pc.	Dimensions Cylinder	Dimensions Basket	Open Area To Pipe Size Ratio	Weight Pounds	Spare Gasket Kit* Dealer Pkg. - 5 kts 1 Kit. per Bag
1/2	5-3/4	4-1/2	493 004 PLB	3-1/2 x 4	1-13/16 x 4-3/8	30:1	5	493 DP4 99M (or) 99R
3/4	8-3/8	4-1/2	493 005 PLB	3-1/2 x 6	1-13/16 x 6-1/4	25:1	5	493 DP5 99M (or) 99R
1	9-1/2	5-1/2	493 006 PLB	4-1/2 x 5-1/2	2-5/8 x 5-7/8	20:1	8	493 DP6 99M (or) 99R
1-1/4	10	5-1/2	493 007 PLB	4-1/2 x 6	2-5/8 x 6-1/4	13:1	8	493 DP7 99M (or) 99R
1-1/2	11-1/2	7-1/4	493 008 PLB	6 x 8	3-5/16 x 8-7/16	17:1	14	493 DP8 99M (or) 99R
2	16	7-1/2	493 009 PLB	6 x 12	3-5/16 x 12-1/4	13:1	18	493 DP9 99M (or) 99R
2-1/2	16	7-1/2	493 010 PLB	6 x 12	3-5/16 x 12-1/2	10:1	18	493 DPX 99M (or) 99R

**ORDERING INFORMATION FOR FIG. 500**

Pipe Size	Height Overall	Width Overall	Standard Pkg. - 1 Pc.	Dimensions Cylinder	Dimensions Basket	Open Area To Pipe Size Ratio	Weight Pounds	Spare Gasket Kit* Standard Pkg. - 1 kit
2	14-1/2	9	500 009 PLB	8 x 10	3-7/8 x 10-1/4	20:1	34	500 DP9 99M (or) 99R
2-1/2	16-1/2	9	500 010 PLB	8 x 12	3-7/8 x 12-1/4	18:1	34	500 DP9 99M (or) 99R
3	18-1/2	9	500 011 PLB	8 x 14	3-7/8 x 14-1/4	14:1	34	500 DP9 99M (or) 99R

\*Spare Gasket Kit Consists of: 1 - Cover Gasket and 2 - Cylinder Gaskets.

**SEE PAGE 99 & 101 FOR THE INTAKE WATER STRAINER SPARE PARTS ORDERING INFORMATION.**

## INTAKE WATER STRAINERS

**FIGS. 493 & 500 - INTAKE WATER STRAINERS SPARE PARTS ORDERING INFORMATION**

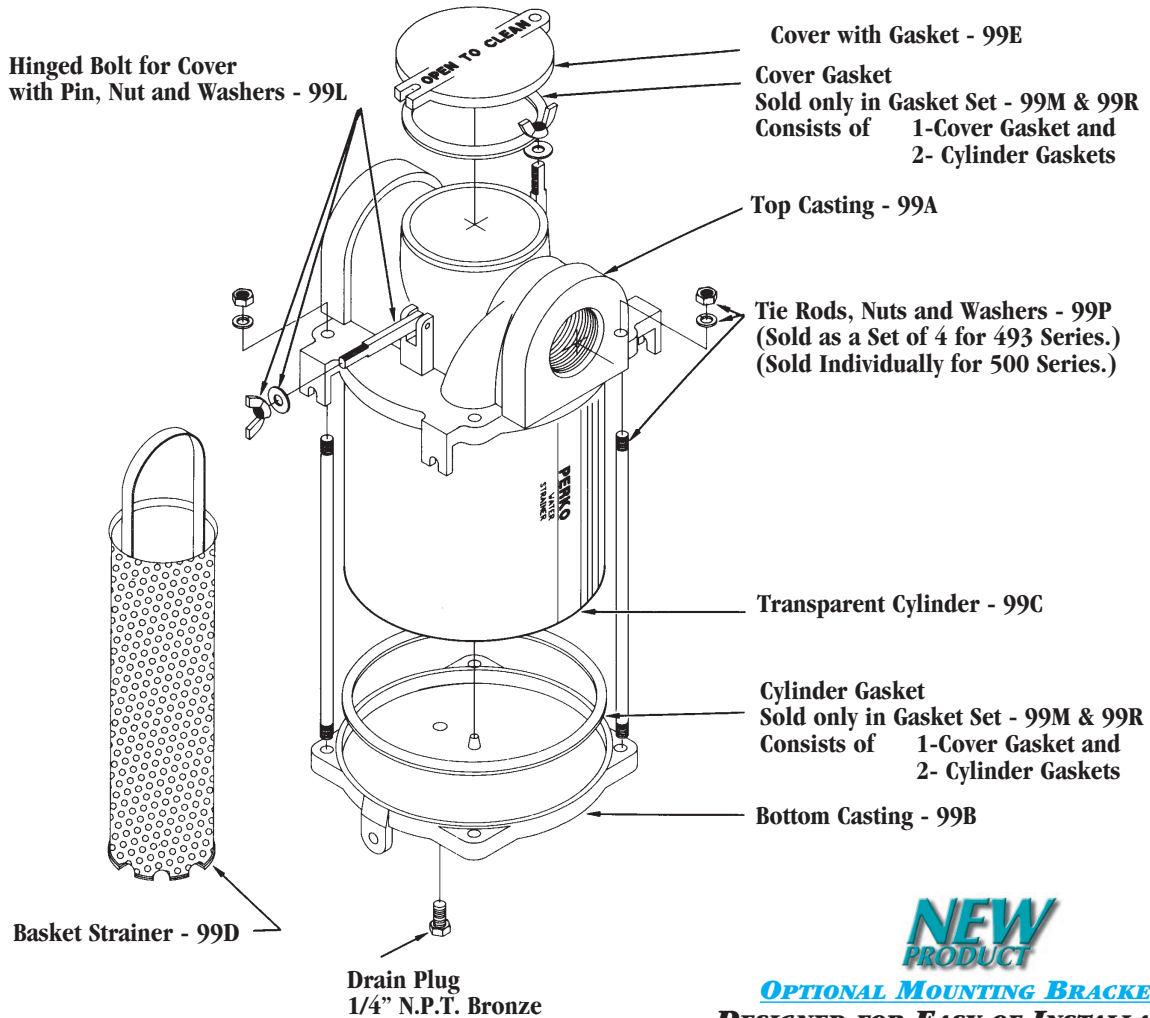

**NEW PRODUCT**

**OPTIONAL MOUNTING BRACKET.**  
**DESIGNED FOR EASY OF INSTALLATION.**  
**OF FIG. 493 SERIES WATER STRAINERS**



PART NUMBER	FITS STRAINER SIZE
493 045 BKT	4 & 5
493 067 BKT	6 & 7
493 089 BKT	9

**FIGS. 493 & 500 - DIFFERENTIAL PRESSURE GRAPHS**

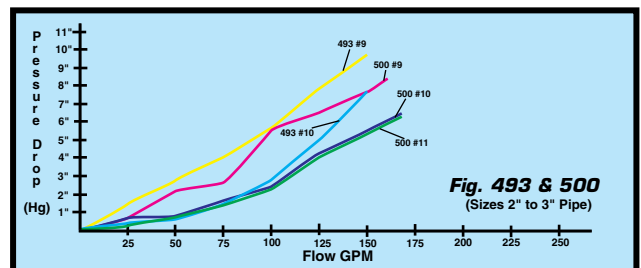
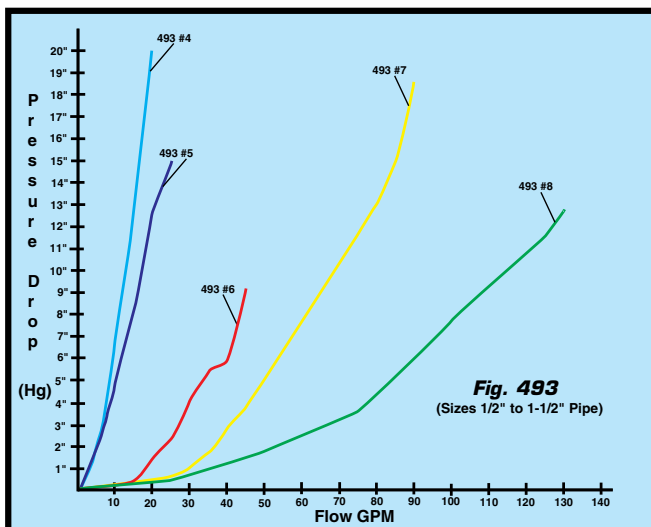

UNDERWATER HDWE, DECK PLATES, FILLS & VENTS

## STRAINERS



**FIG. 65 - INTAKE STRAINER**

**CONSTRUCTION:**

\* **CAST BRONZE**

\* **MACHINED SLOTS**



**Fig. 65**

**ORDERING INFORMATION**

Max. Pipe Size Inches	Max. Hull Thickness Inches	Dimensions Strainer Inches	Dealer Pkg. 5 Pcs	OEM Bulk Pkg. 10 Pcs.	Weight Pounds
1/2	2-1/4	3 x 4	65 DP4 PLB	65 004 PLB	3/4
3/4	2-3/16	3 x 4	65 DP5 PLB	65 005 PLB	1
1	2-1/2	3 x 4	65 DP6 PLB	65 006 PLB	1-1/4
1-1/4	3	3-1/4 x 4-1/4	65 DP7 PLB	65 007 PLB	2

Screw Size #8.

Spare Flanged Nut See Fig. 75, on page 112.



**FIG. 66 - SCOOP STRAINER**

**CONSTRUCTION:**

\* **CAST BRONZE**

\* **MACHINED SLOTS**



**Fig. 66**

**ORDERING INFORMATION**

For Thru-Hull Sizes Inches	Dimensions Strainer Inches	Dealer Pkg. 5 Pcs	Standard Package - 5 Pc.	Weight Pounds
3/8 & 1/2	3-1/2 x 2-1/2	66 DP1 PLB	66 001 PLB	3/8
3/4 & 1	5 x 3-1/4	66 DP2 PLB	66 002 PLB	3/4
1-1/4 & 1-1/2	6-1/4 x 4-1/4	66 DP3 PLB	66 003 PLB	1-1/8
2	8 x 5-1/8	66 DP4 PLB	66 004 PLB	1-3/4

Screw Size #8.



**FIG. 86 - ROUND STRAINER**

**CONSTRUCTION:**

\* **CAST BRONZE**

\* **DRILLED HOLES**



**Fig. 86**

**ORDERING INFORMATION**

For Thru-Hull Sizes Inches	O.D. Inches	I.D. Inches	Dealer Pkg. 5 Pcs.	Standard Package - 5 Pcs.	Screw Size	Weight Pounds
3/8 & 1/2	2-1/2	1-5/8	86 DP1 PLB	86 001 PLB	8	3/16
3/4	3	2	86 DP2 PLB	**86 002 PLB	8	1/4
1	3-1/2	2-3/8	86 DP3 PLB	86 003 PLB	8	3/8
1-1/4 & 1-1/2	4	3	86 DP4 PLB	86 004 PLB	8	1/2
2	5	3-3/4	86 DP5 PLB	86 005 PLB	8	3/4
2-1/2	6	4-1/2	-----	*86 006 PLB	10	1-1/4
3	8	6-1/4	-----	*86 007 PLB	10	2-1/2

\* Standard Package - 1 pc.

\*\* Standard Package - 25 pcs.



## PUMP STRAINERS & GARBOARD DRAIN PLUG

**FIG. 709 - PUMP STRAINER**

**CONSTRUCTION:**

**\* CAST BRONZE**



**ORDERING INFORMATION**

Hose Size Inches	Length Overall Inches	Width Overall Inches	Dealer Pkg. 5 Pcs.	Weight Ounces
5/8	3-5/8	1-3/4	709 DP PLB	6

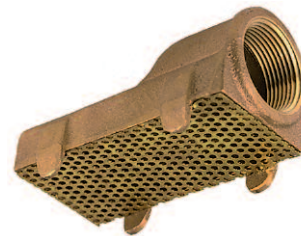

**Fig. 709**

**FIG. 721 & 722 - PUMP STRAINERS**

**CONSTRUCTION:**

**\* CAST BRONZE**



**Fig. 721**

**ORDERING INFORMATION**

Pipe Size Inches	Length Overall Inches	Width Overall Inches	Standard Package - 1 Pc.	Weight Pounds
1-1/4	4-3/4	2-3/4	721 000 PLB	1-3/4
1-1/4	4-1/2	2-3/4	722 000 PLB	1-3/8

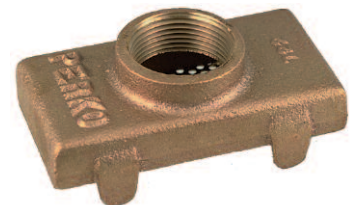

**Fig. 722**

**FIG. 124 - GARBOARD DRAIN PLUG**

**CONSTRUCTION:**

- \* CAST BRONZE FLANGE**
- \* BRASS PLUG**
- \* COMPLETE WITH ZINC ALLOY PLATED STEEL WRENCH**



**ORDERING INFORMATION**

Pipe Size Inches	Length Threaded Neck Inches	O.D. Flange Inches	Standard Package - 5 Pcs.	Screw Size	Weight Pounds
1	1	3-1/8	124 000 PLB	10	1-1/4



**Fig. 124**

Spare Wrench, Cat. No. 124 000 99A.

Spare Plug, Cat. No. 124 000 99B.

UNDERWATER HDVVE, DECK PLATES, FILLS & VENTS

## GARBOARD DRAIN PLUGS



**FIG. 266**

**FIG. 266 - GARBOARD DRAIN PLUG**

**CONSTRUCTION:**

\* **CAST BRONZE**



**ORDERING INFORMATION**

Pipe Size Inches	Length Threaded Neck Inches	O.D. Flange Inches	Dealer Pkg. 5 Cards 1 Pc. per Card	OEM Bulk Pkg. 25 Pcs.	Screw Size	Weight Ounces
3/4	5/8	2-3/8	266 DP PLB	266 000 PLB	8	12

Spare Plug, Cat. No. 370 DP PLB.



**FIG. 363**

**FIG. 363 - GARBOARD DRAIN PLUG**

**CONSTRUCTION:**

\* **CAST BRONZE**



**ORDERING INFORMATION**

Pipe Size Inches	Maximum Hull Thickness Inches	Length Threaded Neck Inches	O.D. Flange Inches	Dealer Pkg. 5 Cards 1 Pc. per Card	OEM Bulk Pkg. 25 Pcs.	Weight Ounces
3/4	3/4	1-1/4	2-3/8	363 DP PLB	363 000 PLB	15

Spare Plug, Cat. No. 370 DP PLB.



**FIG. 714 No. 1**

**FIG. 714 - GARBOARD DRAIN PLUG**

**CONSTRUCTION:**

\* **CAST BRONZE FLANGE WITH BRASS PLUG**  
**NO. 2 STYLE HAS STAINLESS STEEL PIN**



**ORDERING INFORMATION**

Pipe Size Inches	O.D. Flange Inches	Dealer Pkg. 5 Cards 1 Pc. per Card	OEM Bulk Pkg. 50 Pcs.	Screw Size	Weight Ounces
1/2	2	714 DP1 PLB	714 001 PLB	8	4
1/2	2	714 DP2 PLB	714 002 PLB	8	4

Spare No. 1 Plug, Cat. No. 742 DP1.

Spare No. 2 Plug, Cat. No. 742 DP2.



**FIG. 714 No. 2**

UNDERWATER HOME, DECK PLATES, FILLS & VENTS



## SEACOCKS

### FIGS. 834 & 835 - SEACOCKS - BALL VALVE DESIGN

#### CONSTRUCTION:

\* **CAST BRONZE**

**FIG. 834 - WITH 90° CURVED HOSE ADAPTER**

**FIG. 835 - WITH STRAIGHT HOSE ADAPTER**



Includes Thru-Hull, Hose Adapter, Drain Plug, Four Pre-Drilled Mounting Holes and Bonding Screw.

PERKO Seacocks Incorporate a Plastic Ball and Seat Assuring a Tight Seal and Ease of Operation. Drain Plugs for Winterizing. Handles are Easily Removed.



#### ORDERING INFORMATION

Hose Size Inches	Pipe Size Inches	Flange Diameter Inches	Fig. 834 Overall Height*	Fig. 834 Standard Package - 1 Pc.	Fig. 835 Overall Height*	Fig. 835 Standard Package - 1 Pc.	OEM Bulk Pkg.	Bolt Size	Weight Pounds
3/4	3/4	3-1/4	5-7/8	834 005 PLB	5	835 005 PLB	5	5/16	3-1/8
1	1	4-3/8	6-3/8	834 006 PLB	5-3/8	835 006 PLB	---	3/8	5-1/8
1-1/4	1-1/4	4-7/8	7-5/8	834 007 PLB	6-1/4	835 007 PLB	5	3/8	6-3/4
1-1/2	1-1/2	5-1/2	8-3/8	834 008 PLB	6-5/8	835 008 PLB	5	3/8	10
2	2	5-3/4	10-3/8	834 009 PLB	7-7/8	835 009 PLB	---	3/8	22
2-1/2	2-1/2	7-1/4	12-1/2	834 010 PLB	10-3/8	835 010 PLB	---	1/2	25
3	3	8	14-3/8	834 011 PLB	12	835 011 PLB	---	1/2	32

\* Overall Height is measured from the top of the hose adapter to the bottom of the flange.

### FIG. 805 - SEACOCK BODY - BALL VALVE DESIGN



#### CONSTRUCTION:

\* **CAST BRONZE**

These Valve Bodies are Offered to Meet the Needs of Applications that Require Extra Long, Scoop or Flush Type Thru-Hulls.

#### ORDERING INFORMATION

Flange Diameter Inches	Overall Height Inches	Pipe Size Inches	Fig. 805 Standard Package - 1 Pc.	OEM Bulk Pkg.	Weight Pounds
3-1/4	3-3/8	3/4	805 005 PLB	5	2-1/2
4-3/8	3-3/4	1	805 006 PLB	5	4
4-7/8	4-1/4	1-1/4	805 007 PLB	5	5-1/8
5-1/2	4-1/2	1-1/2	805 008 PLB	5	6-3/8
5-3/4	5-3/4	2	805 009 PLB	---	11-3/8
7-1/4	7-1/2	2-1/2	805 010 PLB	---	19
8	7-3/4	3	805 011 PLB	---	24

\* Overall Height is measured from the top of the valve body to the bottom of the flange.



**FIG. 805**

#### SPARE PARTS ORDERING INFORMATION

The Repair Kits Listed Below Consist of: 1 Ball, 2 Ball Seats and 2 O-Rings for the Valve Stem.

Pipe Size Inches	Repair Kit	Pipe Size Inches	Repair Kit	Pipe Size Inches	Repair Kit
3/4	805 005 99B	1-1/2	805 008 99B	3	805 011 99B
1	805 006 99B	2	805 009 99B		
1-1/4	805 007 99B	2-1/2	805 010 99B		

UNDERWATER HDWE, DECK PLATES, FILLS & VENTS

## IN LINE VALVE & PIPE TO HOSE ADAPTERS

**FIG. 825 - INLINE VALVE**

**CONSTRUCTION:**

- \* **CAST BRONZE**
- \* **DRAIN PLUG AND BONDING SCREW INCLUDED**
- \* **BALL VALVE FOR SMOOTH OPERATION**



**FIG. 825**

**ORDERING INFORMATION**

Pipe Size Inches	Standard Package - 1 Pc.	OEM Bulk Pkg.	Weight Pounds
1/2	825 004 PLB	10	1
3/4	825 005 PLB	10	1-1/4
1	825 006 PLB	10	1-3/4
1-1/4	825 007 PLB	10	2-3/4
1-1/2	825 008 PLB	5	4-1/4

**FIG. 63 - PIPE TO HOSE ADAPTER**

**CONSTRUCTION:**

- \* **CAST BRONZE**
- \* **CURVED 90 DEGREES**



**FIG. 63**

**ORDERING INFORMATION**

Pipe Size Inches	Hose Size Inches	Length Overall Inches	Dealer Pkg. 5 Pcs.	Standard Package - 1 Pc.	OEM Bulk Pkg.	OEM Bulk Pcs./Pkg.	Weight Pounds
3/4	3/4	4-1/2	63 DP5 PLB	-----	63 005 PLB	25	1/2
1	1	4-3/4	63 DP6 PLB	-----	63 006 PLB	25	3/4
1-1/4	1-1/4	5-1/2	63 DP7 PLB	-----	63 007 PLB	25	1
1-1/2	1-1/2	6	63 DP8 PLB	-----	63 008 PLB	10	1-1/4
2	2	7	-----	63 009 PLB	63 009 PLB*	10	2-1/2
2-1/2	2-1/2	8-1/2	-----	63 010 PLB	-----	---	3-7/8
3	3	10	-----	63 011 PLB	-----	---	6-3/8

NOTE: The Above Item Meets the Requirements of U.S.C.G. Safety Standards, January 31, 1977 for Gasoline Fuel Systems, 33CFR183.

\* New Item



**FIG. 76 - PIPE TO HOSE ADAPTER**

**CONSTRUCTION:**

- \* **CAST BRONZE**
- \* **CAST HEX FOR EASIER INSTALLATION**
- \* **PRECISION MACHINED HOSE BARB**



**IMPROVED PRODUCT**



**FIG. 76**

**ORDERING INFORMATION**

Pipe Size Inches	Hose Size Inches	Length Overall Inches	Dealer Pkg. 5 Cards 1 Pc. per Card	Standard Package - 1 Pc.	OEM Bulk Pkg. 25 Pcs.	Weight Pounds
1/2	5/8	1-5/8	76 DP4 PLB	-----	76 004 PLB	1/8
3/4	3/4	1-3/4	76 DP5 PLB	-----	76 005 PLB	1/4
1	1	1-3/4	76 DP6 PLB	-----	76 006 PLB	3/8
1-1/4	1-1/4	2	76 DP7 PLB	-----	76 007 PLB	1/2
1-1/2	1-1/2	2-1/4	76 DP8 PLB	-----	76 008 PLB	3/4
2	2	2-5/8	-----	76 009 PLB	-----	1
2-1/2	2-1/2	4	-----	76 010 PLB	-----	2-1/8
3	3	5-1/8	-----	76 011 PLB	-----	3

NOTE: The Above Item Meets the Requirements of U.S.C.G. Safety Standards, January 31, 1977 for Gasoline Fuel Systems, 33CFR183.



## THRU-HULL CONNECTIONS

**FIG. 350 - THRU-HULL CONNECTION FOR USE WITH HOSE**

**CONSTRUCTION OPTIONS:**

- \* **CAST BRONZE, PLAIN OR CHROME PLATED**
- \* **REGULAR OR SHORT LENGTH VERSIONS**

**FLANGE IS MACHINED TO FIT HULL AND GROOVED TO RETAIN BEDDING COMPOUND.  
NECK IS THREADED TO APPROXIMATELY 3/16 INCH FROM FLANGE.**

**REGULAR LENGTH** - Fits Maximum Hull Thickness up to 2 Inches.

**SHORT LENGTH** - For Thin Hull Sections up to 5/8 Inches Maximum.

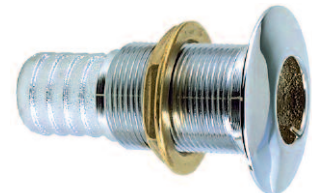

**FIG. 350 CHROME  
REGULAR LENGTH**



**FIG. 350 PLAIN  
REGULAR LENGTH**



**FIG. 350 CHR  
SHORT LENGTH**



**ILLUSTRATION OF  
BEDDING GROOVE**



**ORDERING INFORMATION**

**REGULAR LENGTH - PLAIN BRONZE**

Max. Hose Size Inches	Hull Thickness Inches	O.D. Flange Inches	Plain Bronze Dealer Pkg. 5 Pcs.	Plain Bronze OEM Bulk Pkg. 10 Pcs.	Weight Pounds
5/8	1-1/16	1-1/2	350 004 DPP	350 004 PLB	3/8
3/4	1-5/8	1-7/8	350 005 DPP	350 005 PLB	1/2
1	1-3/4	2-1/4	350 006 DPP	350 006 PLB	7/8
1-1/8	1-3/4	2-1/4	350 06A DPP	350 06A PLB	7/8
1-1/4	1-7/8	2-3/4	350 007 DPP	350 007 PLB	1-3/8
1-1/2	1-7/8	3-1/8	350 008 DPP	350 008 PLB	1-1/2
2	2	3-3/4	-----	350 009 PLB*	1-7/8

**REGULAR LENGTH - CHROME PLATED BRONZE**

Max. Hose Size Inches	Hull Thickness Inches	O.D. Flange Inches	Chr. Plated Bronze Dealer Pkg. 5 Pcs.	Chr. Plated Bronze OEM Bulk Pkg. 10 Pcs.	Weight Pounds
5/8	1-1/16	1-1/2	350 004 DPC	350 004 CHR	3/8
3/4	1-5/8	1-7/8	350 005 DPC	350 005 CHR	1/2
1	1-3/4	2-1/4	350 006 DPC	350 006 CHR	7/8
1-1/8	1-3/4	2-1/4	350 06A DPC	350 06A CHR	7/8
1-1/4	1-7/8	2-3/4	350 007 DPC	350 007 CHR	1-3/8
1-1/2	1-7/8	3-1/8	350 008 DPC	350 008 CHR	1-1/2
2	2	3-3/4	-----	350 009 CHR*	1-7/8

**SHORT LENGTH - PLAIN BRONZE**

Max. Hose Size Inches	Hull Thickness Inches	O.D. Flange Inches	Plain Bronze Dealer Pkg. 5 Pcs.	Plain Bronze OEM Bulk Pkg. 10 Pcs.	Weight Pounds
5/8	5/8	1-1/2	350 S04 DPP	350 S04 PLB	1/4
3/4	5/8	1-7/8	350 S05 DPP	350 S05 PLB	3/8
1	5/8	2-1/4	350 S06 DPP	350 S06 PLB	1/2
1-1/8	5/8	2-1/4	350 S6A DPP	350 S6A PLB	1/2
1-1/4	5/8	2-3/4	350 S07 DPP	350 S07 PLB	3/4
1-1/2	5/8	3-1/8	350 S08 DPP	350 S08 PLB	1-1/16

**SHORT LENGTH - CHROME PLATED BRONZE**

Max. Hose Size Inches	Hull Thickness Inches	O.D. Flange Inches	Chr. Plated Bronze Dealer Pkg. 5 Pcs.	Chr. Plated Bronze OEM Bulk Pkg. 10 Pcs.	Weight Pounds
5/8	5/8	1-1/2	350 S04 DPC	350 S04 CHR	1/4
3/4	5/8	1-7/8	350 S05 DPC	350 S05 CHR	3/8
1	5/8	2-1/4	350 S06 DPC	350 S06 CHR	1/2
1-1/8	5/8	2-1/4	350 S6A DPC	350 S6A CHR	1/2
1-1/4	5/8	2-3/4	350 S07 DPC	350 S07 CHR	3/4
1-1/2	5/8	3-1/8	350 S08 DPC	350 S08 CHR	1-1/16

\*OEM Bulk Pkg 1 Pc.

Spare Flanged Nut See Fig. 75, on page 112.

\*\*NOTE: Thru-Hull Connections For Use With Hose Are Not Recommended For Use Below The Waterline Per A.B.Y.C. "Safety Standards For Small Craft" Section H-27.



UNDERWATER HDWE, DECK PLATES, FILLS & VENTS

## THRU-HULL CONNECTIONS

**FIG. 331 - FLUSH MOUNT THRU-HULL CONNECTION FOR USE WITH PIPE**



**CONSTRUCTION:**

**\* CAST BRONZE**

THE EXTERIOR SURFACE OF THE FLANGE IS MACHINED FLAT AND DESIGNED TO BE COUNTERSUNK INTO THE HULL, RESULTING IN A SMOOTH EXTERNAL FIT WITH NO RAISED PORTION TO INCREASE DRAG.



**Fig. 331**



**ORDERING INFORMATION**

Pipe Size Inches	Max. Hull Thickness Inches	O.D. Flange Inches	Dealer Pkg. 5Pcs	OEM Bulk Package	OEM Bulk Pkg. Qty	Weight Pounds
1/2	2-3/16	1-11/16	331 DP4 PLB	331 004 PLB	10	3/8
3/4	2-3/8	2	331 DP5 PLB	331 005 PLB	10	1/2
1	2-9/16	2-1/4	331 DP6 PLB	331 006 PLB	10	1
1-1/4	2-15/16	2-7/8	331 DP7 PLB	331 007 PLB	10	1-1/4
1-1/2	3-1/16	2-31/32	331 DP8 PLB	331 008 PLB	10	1-3/8
2	3-3/8	3-7/8	-----	331 009 PLB	1	2

Spare Flanged Nut See Fig. 75, on page 112.

**FIG. 348 - EXTRA LONG THRU-HULL CONNECTION FOR USE WITH PIPE**



**CONSTRUCTION:**

**\* CAST BRONZE**

FLANGE IS MACHINED TO FIT HULL AND GROOVED TO RETAIN BEDDING COMPOUND.

NECK IS THREADED TO APPROXIMATELY 3/8 INCH FROM FLANGE.



ILLUSTRATION OF BEDDING GROOVE

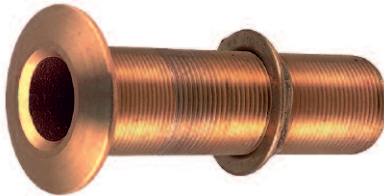

**Fig. 348**



**ORDERING INFORMATION**

Pipe Size Inches	Max. Hull Thickness Inches	O.D. Flange Inches	Dealer Pkg. 5 Pcs.	OEM Bulk Package	OEM Bulk Pkg. Qty	Weight Pounds
3/4	5	1-7/8	348 DP5 PLB	348 005 PLB	25	7/8
1	4-7/8	2-1/4	348 DP6 PLB	348 006 PLB	10	1-1/4
1-1/4	4-5/8	2-3/4	348 DP7 PLB	348 007 PLB	10	2-1/8
1-1/2	4-5/8	3	348 DP8 PLB	348 008 PLB	10	2-1/4
2	4-1/2	3-5/8	-----	348 009 PLB	1	3
2-1/2	4-1/4	4-5/16	-----	348 010 PLB	1	4

Spare Flanged Nut See Fig. 75, on page 112.

**FIG. 322 - THRU-HULL CONNECTION FOR USE WITH PIPE**



**CONSTRUCTION:**

**\* CAST BRONZE**

FLANGE IS MACHINED TO FIT HULL AND GROOVED TO RETAIN BEDDING COMPOUND.

NECK IS THREADED TO APPROXIMATELY 3/8 INCH FROM FLANGE.



ILLUSTRATION OF BEDDING GROOVE

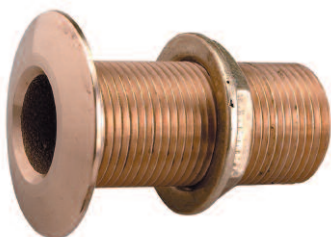

**Fig. 322**



**ORDERING INFORMATION**

Pipe Size Inches	Max. Hull Thickness Inches	O.D. Flange Inches	Dealer Pkg. 5 Cards	Standard Package - 1 Pc.	OEM Bulk Pkg. 25 Pcs.	Weight Pounds
3/8	1-3/4	1-7/16	322 DP3 PLB	-----	322 003 PLB	3/8
1/2	1-3/8	1-1/2	322 DP4 PLB	-----	322 004 PLB	3/8
3/4	1-1/2	1-7/8	322 DP5 PLB	-----	322 005 PLB	1/2
1	1-7/8	2-3/16	322 DP6 PLB	-----	322 006 PLB	7/8
1-1/4	2	2-3/4	322 DP7 PLB	-----	322 007 PLB	1-1/8
1-1/2	2-1/4	3	322 DP8 PLB	-----	*322 008 PLB	1-3/4
2	2-3/8	3-5/8	-----	322 009 PLB	*322 009 PLB	2
2-1/2	2-5/8	4-1/2	-----	322 010 PLB	-----	3-1/2
3	2-3/4	5	-----	322 011 PLB	-----	5

\* O.E.M. Bulk Pkg. - 10 pcs

Spare Flanged Nut See Fig. 75, on page 112.

UNDERWATER HOME, DECK PLATES, FILLS & VENTS

## THRU-HULL CONNECTIONS

**FIG. 301 - THRU-HULL CONNECTION FOR USE WITH HOSE\*\***



**CONSTRUCTION:**

- \* **MOLDED WHITE PLASTIC**
- \* **NARROW FLANGE**



**Fig. 301**



**ORDERING INFORMATION**

Hose Size Inches	Max. Hull Thickness Inches	O.D. Flange Inches	Dealer Pkg. 10 Pcs.	OEM Bulk Pkg. 100 Pcs.	Weight Ounces
1/2	1-1/4	1-1/4	301 DP4	301 004	1
5/8	1-1/4	1-1/4	301 DP4A	301 04A	1
3/4	1-7/16	1-1/2	301 DP5	301 005	1-1/2
1	1-1/2	1-7/8	301 DP6	***301 006	2
1-1/8	1-1/2	1-7/8	301 DP6A	***301 06A	2
1-1/2	1-7/8	2-1/2	301 DP8	***301 008	4

\*\*\* OEM Bulk Pkg. - 50 pcs.  
Spare Flanged Nut See Fig. 326 on Page 112.



**FIG. 328 - THRU-HULL CONNECTION FOR USE WITH HOSE\*\***



**CONSTRUCTION:**

- \* **MOLDED WHITE PLASTIC**
- \* **BROAD FLANGE**



**Fig. 328**

**ORDERING INFORMATION**

Hose Size Inches	Max. Hull Thickness Inches	O.D. Flange Inches	Dealer Pkg. 10 Pcs.	OEM Bulk Pkg. 100 Pcs.	Weight Ounces
1/2	1-1/4	1-1/2	328 DP4	328 004	1
5/8	1-1/4	1-1/2	328 DP4A	328 04A	1
3/4	1-7/16	1-7/8	328 DP5	328 005	1-1/2
1	1-1/2	2-1/4	328 DP6	***328 006	2
1-1/8	1-1/2	2-1/4	328 DP6A	***328 06A	2
1-1/2	1-7/8	3	328 DP8	***328 008	4

\*\*\* OEM Bulk Pkg. - 50 Pcs.  
Spare Flanged Nut See Fig. 326 on Page 112.



\*\*NOTE: Thru-Hull Connections For Use With Hose Are Not Recommended For Use Below The Waterline Per A.B.Y.C. "Safety Standards For Small Craft" Section H-27.

UNDERWATER HDWE, DECK PLATES, FILLS & VENTS

## SCUPPERS & DRAIN



**NEW  
PRODUCT**

**FIG. 377 - THRU-HULL SCUPPER FOR USE WITH HOSE**

**CONSTRUCTION OPTIONS:**

- \* **CAST BRONZE**
- \* **PLAIN OR CHROME PLATED**
- \* **RECESSED FLAPPER**

*FLANGE IS MACHINED TO FIT HULL AND GROOVED TO RETAIN BEDDING COMPOUND.*

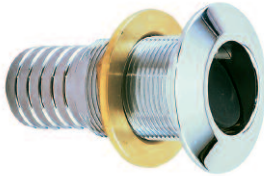

**Fig. 377 A CHR**

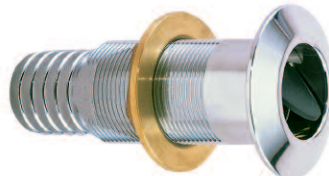

**Fig. 377 B CHR**

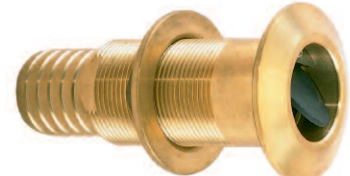

**Fig. 377 B PLB**

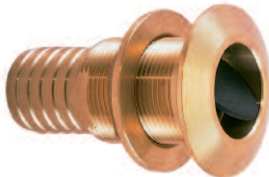

**Fig. 377 A PLB**



**ILLUSTRATION OF  
BEDDING GROOVE**

**ORDERING INFORMATION**

Finish	Hose Size Inches	Maximum Hull Thickness Inches	O.D. Flange Inches	OEM Bulk Pkg. 10 Pcs.	Weight Pounds
Chrome	1-1/2	1-3/4	3-1/8	377 A08 CHR	1-1/2
Plain	1-1/2	1-3/4	3-1/8	377 A08 PLB	1-1/2
Chrome	2	2	3-3/4	377 A09 CHR*	1-7/8
Plain	2	2	3-3/4	377 A09 PLB*	1-7/8
Chrome	1-1/2	3	3-1/8	377 B08 CHR	1-3/4
Plain	1-1/2	3	3-1/8	377 B08 PLB	1-3/4

Spare Flanged Nut See Fig. 75, on page 112.

\* New Item

NOTE: Thru-Hull Connections For Use With Hose Are Not Recommended For Use Below The Waterline Per A.B.Y.C. "Safety Standards For Small Craft" Section H-27.

**NEW  
PRODUCT**

**FIG. 361 - FLUSH MOUNT DRAIN FOR USE WITH PIPE**

**CONSTRUCTION:**

- \* **CHROME PLATED CAST BRONZE BODY WITH BRASS SCREEN**

*THE EXTERIOR SURFACE OF THE FLANGE IS MACHINED FLAT AND DESIGNED TO BE COUNTERSUNK INTO THE HULL, RESULTING IN A SMOOTH EXTERNAL FIT.*



**Fig. 361**

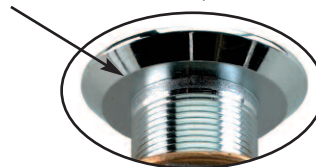

**ORDERING INFORMATION**

Pipe Size Inches	Maximum Thickness Inches	O.D. Flange Inches	Standard Package - 1 Pc.	OEM Bulk Pkg.	Weight Pounds
3/4	2-3/8	2	361 005 CHR	10	1/2
1-1/4	2-15/16	2-7/8	361 007 CHR	10	1-1/4

Spare Flanged Nut See Fig. 75, on page 112.

## SCUPPERS

**FIG. 323 - THRU-HULL SCUPPER FOR MOUNTING THROUGH TRANSOM**

**CONSTRUCTION:**

\* **MOLDED WHITE PLASTIC**

\* **SOFT BLACK FLAPPER**

**NUT AND MOUNTING HARDWARE INCLUDED**



**ORDERING INFORMATION**

Hose Size Inches	Max. Hull Thickness Inches	O.D. Flange Inches	Dealer Pkg. 5 Cards 1 Pc. per Card	OEM Bulk Pkg. 50 Pcs.	Weight Ounces
1-1/2	2-1/8	2-7/8	323 DP	323	5

Spare Flanged Nut See Fig. 326, on page 112.



**FIG. 323**

**FIG. 327 - THRU-HULL SCUPPER FOR MOUNTING THROUGH TRANSOM**

**CONSTRUCTION:**

\* **MOLDED WHITE PLASTIC**

\* **RECESSED SOFT BLACK FLAPPER**

**NUT AND MOUNTING HARDWARE INCLUDED**

**ORDERING INFORMATION**

Hose Size Inches	Max. Hull Thickness Inches	O.D. Flange Inches	OEM Bulk Pkg. 50 Pcs.	Weight Ounces
1-1/2	3-1/4	2-7/8	327	5

Spare Flanged Nut See Fig. 326, on page 112.



**FIG. 327**

**FIG. 333 - THRU-HULL SCUPPER FOR MOUNTING THROUGH TRANSOM**

**CONSTRUCTION:**

\* **MOLDED WHITE PLASTIC**

\* **RECESSED SOFT BLACK FLAPPER**

**NUT AND MOUNTING HARDWARE INCLUDED**



**ORDERING INFORMATION**

Hose Size Inches	Max. Hull Thickness Inches	O.D. Flange Inches	Dealer Pkg. 5 Cards 1 Pc. per Card	OEM Bulk Pkg. 50 Pcs.	Weight Ounces
1-1/2	2-1/8	3	333 DP	333	5

Spare Flanged Nut See Fig. 326, on page 112.

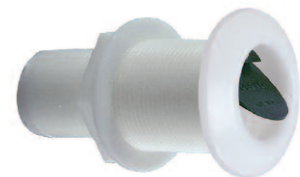

**FIG. 333**

NOTE: The Above Thru-Hull Connections For Use With Hose Are Not Recommended For Use Below The Waterline Per A.B.Y.C. "Safety Standards For Small Craft" Section H-27.

**FIG. 343 - ADJUSTABLE THRU-HULL SCUPPER**

**CONSTRUCTION:**

\* **MOLDED WHITE PLASTIC**

\* **RECESSED SOFT BLACK FLAPPER**

Designed for Surface Thickness from 2 inches to 4-3/4 inches.  
Female portion of scupper can be cut down by one rib for each 1/4 inch difference between hull thickness and 4-3/4 inches.



**ORDERING INFORMATION**

I.D. Inches	Max. Hull Thickness Inches	O.D. Flange Inches	Dealer Pkg. 5 Cards 1 Pc. per Card	OEM Bulk Pkg. 50 Pcs.	Weight Ounces
1-11/32	4-3/4	2-15/16	343 DP	343	5



**FIG. 343**

UNDERWATER HDWE, DECK PLATES, FILLS & VENTS

## SCUPPERS

**FIG. 142 - COCKPIT SCUPPER**

**FOR USE WHEN DISCHARGE IS BELOW THE WATERLINE.**

**CONSTRUCTION OPTIONS:**

- \* **PLAIN OR CHROME PLATED CAST BRONZE**
- \* **RUBBER CHECK BALL**
- \* **DECK KEY INCLUDED**
- \* **ANGLE OF OUTLET IS 45 DEGREES**



**Fig. 142**

**ORDERING INFORMATION**

Hose Size Inches	O.D. Grate Inches	O.D. Flange Inches	Plain Bronze Std. Pkg. - 1 Pc.	Chrome Plated Bronze Std. Pkg. - 1 Pc.	Screw Size	Weight Pounds
1	1-13/16	3-1/4	142 001 PLB	142 001 CHR	8	1-1/2
1-1/2	2-1/4	3-5/8	142 002 PLB	*142 002 CHR	8	2-5/8

\* O.E.M. Bulk Pkg. - 10 pcs.

**SPARE PARTS ORDERING INFORMATION**

Hose Size Inches	Plain Bronze Grate	Chrome Plated Bronze Grate	Check Ball Only	Spare Key Only
1	142 P01 99A	142 C01 99A	142 001 99B	1248 7-8 DP
1-1/2	142 P02 99A	142 C02 99A	142 002 99B	1248 7-8 DP

**FIG. 285 - FLUSH MOUNT COCKPIT SCUPPER FOR USE WITH HOSE**

**FOR USE WHEN DISCHARGE IS ABOVE THE WATERLINE.**

**CONSTRUCTION OPTIONS:**

- \* **MOLDED WHITE PLASTIC**

**INSERT PREVENTS PASSAGE OF LARGE OBJECTS WITHOUT RESTRICTING WATER FLOW.**



**Fig. 285**

**ORDERING INFORMATION**

Hose Size Inches	Max. Hull Thickness Inches	O.D. Flange Inches	I.D. Inches	Dealer Pkg. 5 Cards 1 Pc. per Card	OEM Bulk Pkg. 50 Pcs.	Weight Ounces
1-1/2	1-3/4	2-3/4	1-1/2	285 DP	285	5

Spare Flanged Nut See Fig. 326, on page 112.

**FIG. 365 - SCUPPER VALVE ASSEMBLY FOR SURFACE MOUNT APPLICATIONS**

**CONSTRUCTION:**

- \* **MOLDED WHITE PLASTIC.**
- \* **SOFT BLACK FLAPPER**

**THRU-HULL AND MOUNTING HARDWARE NOT INCLUDED.**



**Fig. 365**

**ORDERING INFORMATION**

O.D. Flange Inches	Dealer Pkg. - 5 Cards 1 Pc. per Card	OEM Bulk Pkg. 50 Pcs.	Screw Size	Weight Ounces
2-7/8	365 DP	365	6	1

**FIG. 75 - SPARE FLANGED LOCK NUT**

**CONSTRUCTION: \* CAST BRONZE**

**FIG. 326 - SPARE FLANGED LOCK NUT**

**CONSTRUCTION: \* MOLDED WHITE PLASTIC**



**Fig. 75**



**Fig. 326**

**ORDERING INFORMATION**

Pipe Size Inches	Cast Bronze Nut	Dealer Pkg. Pcs.	White Plastic Dealer Pkg. - 10 Pcs.	White Plastic OEM Bulk Pkg.	Bulk Pkg. Qty.
3/8	75 003 DPP	5	-----	-----	---
1/2	75 004 DPP	5	326 DP4	326 004	100
3/4	75 005 DPP	5	326 DP5	326 005	100
1	75 006 DPP	5	326 DP6	326 006	50
1-1/4	75 007 DPP	5	-----	-----	---
1-1/2	75 008 DPP	1	326 DP8	326 008	50
2	75 009 DPP	1	-----	-----	---
2-1/2	75 010 DPP	1	-----	-----	---
3	75 011 DPP	1	-----	-----	---



## WATER FITTINGS & DECK PLATE

**FIG. 499 - WATER INLET FITTING**  
FOR OBTAINING WATER AT DOCKSIDE

**CONSTRUCTION:**

- \* CHROME PLATED BRONZE
- \* STANDARD FEMALE SWIVEL HOSE CONNECTOR
- \* BLACK PLASTIC WATERTIGHT PLUG
- \* STAINLESS STEEL BEAD CHAIN



**ORDERING INFORMATION**

Pipe Size Inches	O.D. Flange Inches	Dealer Pkg. - 5 Cards 1 Pc. per Card	OEM Bulk Pkg. 10 Pcs.	Screw Size	Weight Ounces
1/2	2-3/4	499 DP CHR	499 000 CHR	8	8

Spare Plug with Chain, Cat. No. 499 DP 99A.



**FIG. 499**

**FIG. 504 - WATER OUTLET FITTING**  
FOR USE WITH ON-BOARD WASHDOWN SYSTEMS

**CONSTRUCTION:**

- \* CHROME PLATED BRONZE
- \* STANDARD MALE HOSE CONNECTOR
- \* WATERTIGHT BLACK PLASTIC CAP
- \* STAINLESS STEEL BEAD CHAIN



**ORDERING INFORMATION**

Pipe Size Inches	O.D. Flange Inches	Dealer Pkg. - 5 Cards 1 Pc. per Card	OEM Bulk Pkg. 10 Pcs.	Screw Size	Weight Ounces
1/2	2-3/4	504 DP CHR	504 000 CHR	8	8

Spare Cap with Chain, Cat. No. 504 DP 99A.



**FIG. 504**

**FIG. 526 - REGULAR DECK PLATE**

**CONSTRUCTION OPTIONS:**

- \* CAST BRONZE
- \* PLAIN OR CHROME PLATED
- \* DECK KEY INCLUDED

**ORDERING INFORMATION**

I.D. Opening Inches	O.D. Overall Inches	Plain Bronze	Chrome Plated Bronze	Screw Size	Weight Pounds
		Standard Pkg. - 1 Pc.	Standard Pkg. - 1 Pc.		
3	5-3/8	526 003 PLB	526 003 CHR	10	2
4	7-1/16	526 004 PLB	526 004 CHR	10	3-3/8
5	8-3/8	526 005 PLB	526 005 CHR	10	4-3/4
6	9-3/8	526 006 PLB	526 006 CHR	1/4	7-1/2

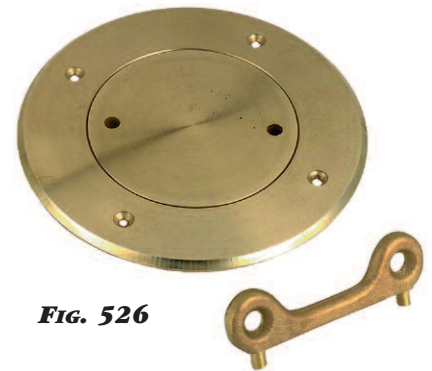

**FIG. 526**

**SPARE PARTS ORDERING INFORMATION**

I.D. Opening Inches	Plain Bronze Cap	Chrome Plated Bronze Cap	Spare Key Only
3	526 P03 99A	526 C03 99A	1248 010 ZNC
4	526 P04 99A	526 C04 99A	539 004 PLB
5	526 P05 99A	526 C05 99A	539 005 PLB
6	526 P06 99A	526 C06 99A	539 006 PLB

UNDERWATER HDVLE, DECK PLATES, FILLS & VENTS

## COMBINATION FILLS & TANK VENTS

**FIGS. 540, 541, 542 & 543 - COMBINATION FILLS & TANK VENTS**

PATENT NOS. 5,275,213 & 5,327,946

### CONSTRUCTION OPTIONS:

**INTEGRAL TANK VENT WITH FLAME ARRESTOR AND ANTI SURGE VALVE  
DECK PLATE KEY INCLUDED**



**FIG. 540**

- \* **540/541 CHROME PLATED BRONZE CAP WITH BLACK PLASTIC BASE**
- FIG. 540 - ANGLED NECK & HEAVY DUTY STAINLESS STEEL BEAD CHAIN**
- FIG. 541 - STRAIGHT NECK & HEAVY DUTY STAINLESS STEEL BEAD CHAIN**
- GROUND WIRE REQUIRED FOR FIGS 540 AND 541 ONLY**

### \* 542/543 BLACK OR WHITE PLASTIC CAP WITH BLACK PLASTIC BASE

**FIG. 542 - ANGLED NECK & BLACK PLASTIC STRAP**

**FIG. 543 - STRAIGHT NECK & BLACK PLASTIC STRAP**



### ORDERING INFORMATION

Marked For:	Cap Type	For Fuel Hose Inches	For Vent Hose Inches	Length Neck Inches	Dealer Pkg 5 Pcs.	OEM Bulk Pkg. 25 Pcs.	Screw Size	Weight Ounces
<b>CHROME CAP &amp; ANGLED NECK</b>								
Gas	Chrome	1-1/2	5/8	2-7/16	540 DPG CHR*	540 G00 CHR*	8	8
Diesel	Chrome	1-1/2	5/8	2-7/16	540 DPD CHR	540 D00 CHR	8	8
Water	Chrome	1-1/2	5/8	2-7/16	540 DPW CHR	540 W00 CHR	8	8
<b>CHROME CAP &amp; STRAIGHT NECK</b>								
Gas	Chrome	1-1/2	5/8	2-7/16	541 DPG CHR*	541 G00 CHR*	8	8
Diesel	Chrome	1-1/2	5/8	2-7/16	541 DPD CHR	541 D00 CHR	8	8
Water	Chrome	1-1/2	5/8	2-7/16	541 DPW CHR	541 W00 CHR	8	8
<b>BLACK OR WHITE PLASTIC CAP &amp; ANGLED NECK</b>								
Gas	Black	1-1/2	5/8	2-7/16	542 DPG BLK*	542 G00 BLK*	8	4
Gas	White	1-1/2	5/8	2-7/16	542 DPG WHT*	542 G00 WHT*	8	4
Water	Black	1-1/2	5/8	2-7/16	542 DPW BLK	542 W00 BLK	8	4
<b>BLACK OR WHITE PLASTIC CAP &amp; STRAIGHT NECK</b>								
Gas	Black	1-1/2	5/8	2-7/16	543 DPG BLK*	543 G00 BLK*	8	4
Gas	White	1-1/2	5/8	2-7/16	543 DPG WHT*	543 G00 WHT*	8	4
Water	Black	1-1/2	5/8	2-7/16	543 DPW BLK	543 W00 BLK	8	4



**FIG. 541**



**FIG. 542**

**FOR A MATCHING WASTE DECK PLATE PLEASE SEE FIG. 556 ON PAGE 120.**

*Note: Consider the use of the Mounting Ring (Fig. 540 DPR BLK) on page 114 for all installations.*



**FIG. 543**



Spare Deck Plate Key Cat. No. 1247 DP BLK.

\*NOTE: These Items Meet the Requirements of U.S.C.G. Safety Standards, January 31, 1977, for Gasoline Fuel Systems, 33CFR183.

## COMBINATION FILLS & TANK VENTS

### FIGS. 1318 - COMBINATION GAS FILL & TANK VENT

PATENT No. 5,275,213

#### CONSTRUCTION OPTIONS:

- \* BLACK OR WHITE PLASTIC
- \* 35° ANGLED NECK
- \* INTEGRAL TANK VENT WITH FLAME ARRESTOR
- \* NO DECK PLATE KEY OR GROUND WIRE REQUIRED
- \* FLIP TOP CAP



#### ORDERING INFORMATION

Marked For:	For Fuel Hose Inches	For Vent Hose Inches	Length Neck Inches	Dealer Pkg. 10 Cards 1 Pc. per Card	OEM Bulk Pkg. 50 Pcs.	Screw Size	Weight Ounces
Gas	1-1/2	5/8	2-7/16	1318 DPG BLK*	1318 G00 BLK*	10	4-1/2



FIG. 1318

### FIGS. 1319 - COMBINATION FILL & TANK VENT

PATENT No. 5,275,213

#### CONSTRUCTION OPTIONS:

- \* BLACK OR WHITE PLASTIC
- \* INTEGRAL TANK VENT WITH FLAME ARRESTOR
- \* NO DECK PLATE KEY OR GROUND WIRE REQUIRED
- \* FLIP TOP CAP



#### ORDERING INFORMATION

Marked For:	For Fuel Hose Inches	For Vent Hose Inches	Length Neck Inches	Dealer Pkg. 10 Cards 1 Pc. per Card	OEM Bulk Pkg. 50 Pcs.	Screw Size	Weight Ounces
Gas	1-1/2	5/8	2-7/16	1319 DPG BLK*	1319 G00 BLK*	10	4-1/2
Gas	1-1/2	5/8	2-7/16	1319 DPG WHT*	1319 G00 WHT*	10	4-1/2
Water	1-1/2	5/8	2-7/16	1319 DPW BLK	1319 W00 BLK	10	4-1/2
Water	1-1/2	5/8	2-7/16	1319 DPW WHT	1319 W00 WHT	10	4-1/2



FIG. 1319

### FIG. 540 RING- SPARE MOUNTING RING

#### INSTALLATION NOTE

ON THE USE OF VENTED FUEL FILLS  
PERKO FIGURE No. 540, 541, 542 & 543

Recommended for use in any application where water might be splashed around a vented fuel fill. The ring raises the opening between the fuel cap and fill an additional 3/8" above the deck surface thereby reducing the likelihood that splashed water will enter the fuel system through the breathing vent. The split ring design permits installation in most cases without disconnecting fuel and vent hoses from the fill. NOTE: The ring will not prevent water from entering the system if the cap becomes submerged or substantially flooded.



#### ORDERING INFORMATION

Dealer Pkg. - 5 Cards 1 Pc Per Card 540 DPR BLK	OEM Bulk Pkg. 50 Pcs. 540 RNG BLK
---	---



FIG. 540 RNG

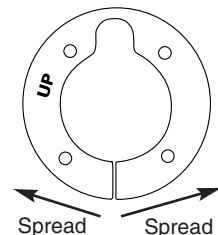

\*NOTE: These Items Meet the Requirements of U.S.C.G. Safety Standards, January 31, 1977, for Gasoline Fuel Systems, 33CFR183.

UNDERWATER HDWE., DECK PLATES, FILLS & VENTS

## DECK PLATES

### FIG. 528 - DECK PLATES FOR PIPE

#### CONSTRUCTION OPTIONS:

- \* CAST BRONZE
- \* PLAIN OR CHROME PLATED
- \* 1-1/4 AND 1-1/2 INCH CAPS HAVE A SLOT BETWEEN THE HOLES
- \* FIG. NO. 1248 DECK PLATE KEY AND O-RING INCLUDED



Fig. 528



Fig. 528 Gas



Fig. 528 Diesel



Fig. 528 Water



#### ORDERING INFORMATION

##### FOR UNMARKED DECK PLATES

Pipe Size Inches	O.D. Flange Inches	Plain Bronze Std. Pkg. - 1 Pc.	Chrome Plated Bronze Std. Pkg. - 1 Pc.	Chrome Plated Bronze OEM Bulk Pkg. 10 Pcs.	Weight Ounces
1	2-7/8	528 006 PLB	528 006 CHR	-----	12
1-1/4	3-5/16	528 007 PLB	528 007 CHR	-----	12
1-1/2	3-5/8	528 008 PLB	*528 DP8 CHR	528 008 CHR	16
2	4-1/4	528 009 PLB	528 009 CHR	-----	33-1/2
2-1/2	4-5/8	528 010 PLB	528 010 CHR	-----	33-1/2
3	5-3/8	528 011 PLB	528 011 CHR	-----	43-1/2

##### \*\*FOR GAS DECK PLATES

Pipe Size Inches	O.D. Flange Inches	Plain Bronze Std. Pkg. - 1 Pc.	Chrome Plated Bronze Std. Pkg. - 1 Pc.	Chrome Plated Bronze OEM Bulk Pkg. 10 Pcs.	Weight Ounces
1-1/2	3-5/8	528 G08 PLB	*528 DPG CHR	528 G08 CHR	16
2	4-1/4	-----	528 G09 CHR	528 G09 CHR	33-1/2

##### FOR DIESEL DECK PLATES

Pipe Size Inches	O.D. Flange Inches	Plain Bronze Std. Pkg. - 1 Pc.	Chrome Plated Bronze Std. Pkg. - 1 Pc.	Chrome Plated Bronze OEM Bulk Pkg. 10 Pcs.	Weight Ounces
1-1/2	3-5/8	528 D08 PLB	*528 DPD CHR	528 D08 CHR	16
2	4-1/4	528 D09 PLB	528 D09 CHR	-----	33-1/2

##### FOR WATER DECK PLATES

Pipe Size Inches	O.D. Flange Inches	Plain Bronze Std. Pkg. - 1 Pc.	Chrome Plated Bronze Dealer Pkg. 5 Cds 1 Pc. per Card	Chrome Plated Bronze OEM Bulk Pkg. 10 Pcs.	Weight Ounces
1-1/2	3-5/8	528 W08 PLB	*528 DPW CHR	528 W08 CHR	16

Screw Sizes: 2-1/2 and 3 Inch Deck Plates #10, All Others #8.

\*\*Note: These Deck Plates Meet the Requirements of U.S.C.G. Safety Standards, January 31, 1977, for Gasoline Fuel Systems, 33CFR183.

\* Dealer Package 5 Pcs., 1 Pc. per Card

FOR MATCHING WASTE DECK PLATES SEE FIG. 524 ON PAGE 120

#### SPARE PARTS ORDERING INFORMATION

Pipe Size Inches	Plain Bronze Cap*	Chrome Plated Bronze Cap*	O-Rings Only (2 per bag, 5 bags/Pkg)	Spare Key
1	528 P06 99A	528 C06 99A	513 006	1248 006 DP
1-1/4	528 P07 99A	528 C07 99A	513 007	1248 7-8 DP***
1-1/2	528 P08 99A	528 DP8 99A**	513 DP8	1248 7-8 DP***
2	528 P09 99A	528 C09 99A	513 009	1248 009 DP
2-1/2	528 P10 99A	528 C10 99A	513 010	1248 010 ZNC
3	528 P11 99A	528 C11 99A	513 011	528 011 99C

\* Complete With O-Ring.

\*\* Dealer Pkg. - 5 pcs. (1 pc. per card).

\*\*\* Dealer Pkg. - 10 pcs. (1 pc. per card).

## FUEL & WATER DECK PLATES

**FIG. 576 - DECK PLATE FOR 2 INCH HOSE**

**NEW  
PRODUCT**

**CONSTRUCTION:**

\* **CHROME PLATED BRONZE**

\* **FIG. NO. 1247 DECK PLATE KEY, O-RING AND INTEGRAL RETAINER ON CAP INCLUDED**



**ORDERING INFORMATION**

Marked For:	Hose Size Inches	O.D. Flange Inches	Length Neck Inches	OEM Bulk Pkg. 25 Pcs. Std. Pkg. 1 Pc.	Screw Size	Weight Ounces
*Gas	2	3-3/8	3-5/8	576 G00 CHR	8	14
Diesel	2	3-3/8	3-5/8	576 D00 CHR	8	14



**Fig. 576**

Spare Gas Cap with O-Ring and Retainer, Cat. No. 576 DPG 99A  
 Spare Diesel Cap with O-Ring and Retainer, Cat. No. 576 DPD 99A  
 Spare Retaining Ring, Cat. No. 537 DP2.  
 Spare Key, Cat. No. 1247 DP BLK.

**FIG. 520/521 - DECK PLATES FOR 1-1/2 INCH HOSE**

**CONSTRUCTION:**

**FIG. 520 - CHROME PLATED BRONZE**

**FIG. 521 - CHROME PLATED BRONZE WITH BLACK PLASTIC CAP**

\* **FIG. NO. 1248 DECK PLATE KEY, O-RING AND INTEGRAL RETAINER ON CAP INCLUDED**

\* **CAPS HAVE A SLOT BETWEEN THE HOLES**



**ORDERING INFORMATION**

Marked For:	Hose Size Inches	O.D. Flange Inches	Length Neck Inches	Dealer Pkg. 5 Cards 1 Pc. per Card	OEM Bulk Pkg. 25 Pcs.	Screw Size	Weight Ounces
*Gas	1-1/2	3-1/8	3-1/2	520 DPG CHR	520 G00 CHR	8	14
Diesel	1-1/2	3-1/8	3-1/2	520 DPD CHR	520 D00 CHR	8	14
Water	1-1/2	3-1/8	3-1/2	520 DPW CHR	520 W00 CHR	8	14
*Gas	1-1/2	3-1/8	3-1/2	521 DPG CHR	521 G00 CHR	8	11
Diesel	1-1/2	3-1/8	3-1/2	521 DPD CHR	521 D00 CHR	8	11
Water	1-1/2	3-1/8	3-1/2	521 DPW CHR	521 W00 CHR	8	11



**Fig. 520**



**Fig. 521**

Spare Cap with O-Ring and Retainer, Cat. No. 520 DP 99A.  
 Spare Diesel Cap with O-Ring and Retainer, Cat. No. 521 DPD 99A.  
 Spare O-Rings Only (2 per bag), Cat. No. 513 DP8

Spare Gas Cap with O-Ring and Retainer, Cat. No. 521 DPG 99A.  
 Spare Water Cap with O-Ring and Retainer, Cat. No. 521 DPW 99A.  
 Spare Key, Cat. No. 1248 7-8 DP.

**FOR MATCHING WASTE DECK PLATES SEE FIGS. 507 & 508 ON PAGE 121.**

\*NOTE: These Items Meet the Requirements of U.S.C.G. Safety Standards, January 31, 1977, for Gasoline Fuel Systems, 33CFR183.

UNDERWATER HDVLE, DECK PLATES, FILLS & VENTS

## FUEL & WATER DECK PLATES

**FIG. 527 - DECK PLATES FOR HOSE**



**FIG. 527**

**CONSTRUCTION:**

- \* **CHROME PLATED BRONZE**
- \* **35° ANGLED HOSE BIBS**
- \* **FIG. No. 1247 KEY, O-RING AND FIG. No. 537 RETAINING CABLE ON CAP INCLUDED**
- \* **CAPS HAVE A SLOT BETWEEN THE HOLES**

**ORDERING INFORMATION**

Marked For:	Hose Size Inches	O.D. Flange Inches	Length Neck Inches	Standard Pkg. - 1 Pc.	Screw Size	Weight Pounds
*Gas	1-1/2	3-1/2	4-7/8	527 G08 CHR	10	2-3/8
Diesel	1-1/2	3-1/2	4-7/8	527 D08 CHR	10	2-3/8

Spare Cap with O-Ring, Cat. No. 528 DP8 99A. Spare O-Rings Only (2 per bag), Cat. No. 513 DP8. Spare Key, Cat. No. 1247 DP BLK.

**FIG. 1270 - DECK PLATE FOR HOSE**



**FIG. 1270**

**CONSTRUCTION:**

- \* **CHROME PLATED ZINC**
- \* **BLACK PLASTIC CAP**
- \* **FIG. No. 1248 DECK PLATE KEY, O-RING AND INTEGRAL RETAINER ON CAP INCLUDED**
- \* **CAPS HAVE A SLOT BETWEEN THE HOLES**

**ORDERING INFORMATION**

Marked For:	Hose Size Inches	O.D. Flange Inches	Length Neck Inches	Dealer Pkg. - 5 Cards 1 Pc. per Card	OEM Bulk Pkg. 25 Pcs.	Screw Size	Weight Ounces
*Gas	1-1/2	3-1/2	2-1/2	1270 DPG CHR	1270 G00 CHR	8	8
Diesel	1-1/2	3-1/2	2-1/2	1270 DPD CHR	1270 D00 CHR	8	8
Water	1-1/2	3-1/2	2-1/2	1270 DPW CHR	1270 W00 CHR	8	8

Spare Gas Cap with O-Ring and Retainer, Cat. No. 1270 DPG 99A.  
 Spare Diesel Cap with O-Ring and Retainer, Cat. No. 1270 DPD 99A.  
 Spare Water Cap with O-Ring and Retainer, Cat. No. 1270 DPW 99A.  
 Spare O-Rings Only (2 per bag), Cat. No. 513 DP8.  
 Spare Key, Cat. No. 1248 7-8 DP.



\*NOTE: These Items Meet the Requirements of U.S.C.G. Safety Standards, January 31, 1977, for Gasoline Fuel Systems, 33CFR183.

UNDERWATER HOSE, DECK PLATES, FILLS & VENTS

## GAS FILLS

### Figs. 1313 & 1399 - Gas Fills

PATENT No. 3,828,714

#### CONSTRUCTION:

- \* CHROME PLATED ZINC ALLOY
- \* BLACK PLASTIC FLANGE
- \* BLACK PLASTIC CAP WITH STRAP
- \* GROUNDING SCREW INCLUDED
- \* CAP RETAINER AND GASKET
- \* LOCKING CAP HAS A COVER FOR THE KEY HOLE



FIG. 1313



FIG. 1399



#### ORDERING INFORMATION

Marked For:	Hose Size Inches	O.D. Flange Inches	Length Neck Inches	Dealer Pkg. - 5 Cards 1 Pc. per Card	OEM Bulk Pkg. 50 Pcs.	Weight Ounces
*Gas	1-1/2	3-1/8	1-7/8	1313 DP CHR	1313 000 CHR	8
*Gas w/Lock	1-1/2	3-1/8	1-7/8	1399 DP CHR	1399 000 CHR	8

Screw Size #6.

Spare Non-Locking Cap, Cat. No. 126 DP BLK.

Spare Locking Cap with 2 keys, Cat. No. 1324 DP BLK.

### Figs. 1613 - Plastic Gas Fill

#### CONSTRUCTION:

- \* FIBER REINFORCED, U.V. STABILIZED BLACK PLASTIC
- \* NO DECK PLATE KEY OR GROUND WIRE REQUIRED
- \* EASY-GRIP CAP
- \* O-RING AND CAP RETAINER INCLUDED



FIG. 1613



#### ORDERING INFORMATION

For Hose Inches	O.D. Overall Inches	Length Neck Inches	Dealer Pkg. - 5 Cards 1 Pc. per Card	OEM Bulk Pkg. 50 Pcs.	Screw Size	Weight Ounces
1-1/2	3-1/16	2-7/16	1613 DP BLK*	1613 000 BLK*	8	4

Spare Cap with O-Ring and Retainer, Cat. No. 1613 000 99A.

Spare O-Rings (2 per bag), Cat. No. 513 DP8.

### Fig. 1413 - Gas Fill

#### CONSTRUCTION:

- \* CHROME PLATED ZINC ALLOY
- \* BLACK PLASTIC CAP AND BASE
- \* INTEGRAL CAP RETAINER/GASKET INCLUDED



#### ORDERING INFORMATION

For Hose Inches	Length Neck Inches	Dimensions Overall Inches	Standard Pkg. 1 Pc.	Screw Size	Weight Ounces
1-1/2	1-7/8	3 x 3	*1413 000 CHR	6	7

Spare Cap, Cat. No. 126 DP BLK.



FIG. 1413

\*NOTE: These Items Meet the Requirements of U.S.C.G. Safety Standards, January 31, 1977, for Gasoline Fuel Systems, 33CFR183.

## WASTE DECK PLATES

**NEW  
PRODUCT**

**FIG. 556 - WASTE DECK PLATE FOR HOSE**

**CONSTRUCTION:**

\* **CHROME PLATED BRONZE**

\* **BLACK PLASTIC BODY**

\* **FIG. No. 1247 DECK PLATE KEY AND O-RING INCLUDED**



**Fig. 556**

**ORDERING INFORMATION**

Hose Size Inches	O.D. Flange Inches	Length Neck Inches	Dealer Pkg. 5 Cards 1 Pc. per Card	OEM Bulk Pkg. 25 Pcs.	Screw Size	Weight Ounces
1-1/2	3-3/8	3-1/8	556 DP CHR	556 000 CHR	8	8

Spare Cap with O-Ring, Cat. No. 556 DP 99A  
Spare Key, Cat. No. 1247 DP BLK.



**FIG. 524 - WASTE DECK PLATE FOR PIPE**

**CONSTRUCTION:**

\* **CHROME PLATED BRONZE**

\* **FIG. No. 1248 DECK PLATE KEY AND O-RING INCLUDED**

\* **CAP HAS A SLOT BETWEEN THE HOLES**



**Fig. 524**

**ORDERING INFORMATION**

Pipe Size Inches	O.D. Flange Inches	Dealer Pkg. - 5 Cards 1 Pc. per Card	OEM Bulk Pkg. 10 Pcs.	Screw Size	Weight Ounces
1-1/2	3-5/8	524 DP CHR	524 000 CHR	8	16

Spare Cap with O-Ring, Cat. No. 524 DP 99A.  
Spare O-Rings Only (2 per bag), Cat. No. 513 DP8.  
Spare Key, Cat. No. 1248 7-8 DP.



NOTE: These Items Comply with Adopted Standards on "Fittings" A.B.Y.C. Recommended Practices Standards Covering Sewage Holding and/or Treatment Devices for Marine Waste Systems.

UNDERWATER HOME, DECK PLATES, FILLS & VENTS



## WASTE DECK PLATES

### FIGS. 507 & 508 - WASTE DECK PLATES FOR HOSE

#### CONSTRUCTION:

- \* FIG. 507 - CHROME PLATED BRONZE
- \* FIG. 508 - CHROME PLATED BRONZE WITH BLACK PLASTIC CAP
- \* FIG. No. 1248 DECK PLATE KEY AND O-RING INCLUDED
- \* CAP HAS A SLOT BETWEEN THE HOLES



FIG. 507



FIG. 508



#### ORDERING INFORMATION

Hose Size	O.D. Flange	Length Neck	Dealer Pkg. 5 Cards 1 Pc. per Card	OEM Bulk Pkg. 25 Pcs.	Screw Size	Weight Ounces
1-1/2	3-1/8	3-1/2	507 DP CHR	507 000 CHR	8	14
1-1/2	3-1/8	3-1/2	508 DP CHR	508 000 CHR	8	11

Spare Cap with O-Ring, Cat. No. 507 DP 99A. Spare Cap with O-Ring, Cat. No. 508 DP 99A.  
 Spare O-Rings Only (2 per bag), Cat. No. 513 DP8.  
 Spare Key, Cat. No. 1248 7-8 DP.

### FIG. 1269 - WASTE DECK PLATE FOR HOSE

#### CONSTRUCTION:

- \* CHROME PLATED ZINC ALLOY
- \* BLACK PLASTIC CAP
- \* FIG. No. 1248 DECK PLATE KEY AND O-RING INCLUDED
- \* CAP HAS A SLOT BETWEEN THE HOLES



FIG. 1269



#### ORDERING INFORMATION

Hose Size	O.D. Flange	Length Neck	Dealer Pkg. 5 Cards 1 Pc. per Card	OEM Bulk Pkg. 25 Pcs.	Screw Size	Weight Ounces
1-1/2	3-1/2	2-1/2	1269 DP CHR	1269 000 CHR	8	8

Spare Cap with O-Ring, Cat. No. 1269 DP 99A.  
 Spare O-Rings Only (2 per bag), Cat. No. 513 DP8.  
 Spare Key, Cat. No. 1248 7-8 DP.

NOTE: These Items Comply with Adopted Standards on "Fittings" A.B.Y.C. Recommended Practices Standards Covering Sewage Holding and/or Treatment Devices for Marine Waste Systems.

UNDERWATER HDVE, DECK PLATES, FILLS & VENTS

## GAS TANK VENTS

**FIG. 570 - GAS TANK VENT**

**CONSTRUCTION:**

- \* CHROME PLATED ZINC ALLOY COWL
- \* BLACK OR WHITE PLASTIC CAP
- \* REMOVABLE 30 MESH STAINLESS STEEL WIRE SCREEN FLAME ARRESTER

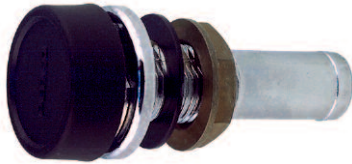

**FIG. 570**

**ORDERING INFORMATION**

Color	Hose Size Inches	Max. Hull Thickness Inches	Dealer Pkg. - 10 Cards 1 Pc. per Card	OEM Bulk Pkg. 50 Pcs.	Weight Ounces
Black	5/8	3/4	570 DP4 BLK	570 004 BLK	3
White	5/8	3/4	570 DP4 WHT	570 004 WHT	3

**FIG. 571 - GAS TANK VENT WITH SWIVEL ELBOW**

**CONSTRUCTION:**

- \* BLACK OR WHITE PLASTIC CAP WITH ZINC ALLOY ELBOW
- \* REMOVABLE 30 MESH STAINLESS STEEL WIRE SCREEN FLAME ARRESTER



**FIG. 571**

DESIGN ALLOWS ELBOW TO BE ROTATED TO ANY POSITION

**ORDERING INFORMATION**

Color	Hose Size Inches	Max. Hull Thickness Inches	Dealer Pkg. - 10 Cards 1 Pc. per Card	OEM Bulk Pkg. 50 Pcs.	Weight Ounces
Black	5/8	3/4	571 DP4 BLK	571 004 BLK	3
White	5/8	3/4	571 DP4 WHT	571 004 WHT	3

**FIG. 561 - GAS TANK VENT WITH SWIVEL ELBOW**

**CONSTRUCTION:**

- \* CHROME PLATED ZINC ALLOY CAP WITH ZINC ALLOY ELBOW
- \* BLACK PLASTIC SPLASH GUARD
- \* REMOVABLE 30 MESH STAINLESS STEEL WIRE SCREEN FLAME ARRESTER



**FIG. 561**

DESIGN ALLOWS ELBOW TO BE ROTATED TO ANY POSITION

**ORDERING INFORMATION**

Hose Size Inches	Max. Hull Thickness Inches	Dealer Pkg. - 10 Cards 1 Pc. per Card	OEM Bulk Pkg. 50 Pcs.	Weight Ounces
5/8	1	561 DP4 CHR	561 004 CHR	3-1/4

Spare Splash Guard Cat. No. 518 000 BLK

**FIG. 506 - GAS TANK VENT**

**CONSTRUCTION:**

- \* CHROME PLATED ZINC ALLOY WITH BLACK PLASTIC SPLASH GUARD
- \* REMOVABLE 30 MESH STAINLESS STEEL WIRE SCREEN FLAME ARRESTER



**FIG. 506**

**ORDERING INFORMATION**

Hose Size Inches	Max. Hull Thickness Inches	Dealer Pkg. - 10 Cards 1 Pc. per Card	OEM Bulk Pkg. 50 Pcs.	Weight Ounces
5/8	3/4	506 DP4 CHR	506 004 CHR	3

Spare Splash Guard Cat. No. 518 000 BLK

**Note: All of the Above Vents are Designed to Meet the Requirements of U.S.C.G. Safety Standards January 31, 1977, for Gasoline Fuel Systems 33CFR183.**

UNDERWATER HOME, DECK PLATES, FILLS & VENTS

## GAS TANK VENTS

### FIG. 509 - GAS TANK VENT

#### CONSTRUCTION:

- \* CHROME PLATED BRONZE
- \* REMOVABLE 30 MESH STAINLESS STEEL WIRE SCREEN FLAME ARRESTER



#### ORDERING INFORMATION

Hose Size Inches	Max. Hull Thickness Inches	Dealer Pkg. - 5 Cards 1 Pc. per Card	OEM Bulk Pkg. 50 Pcs.	Weight Ounces
5/8	3/4	509 DP4 CHR	509 004 CHR	4
3/4	5/8	509 DP5 CHR	509 005 CHR	6

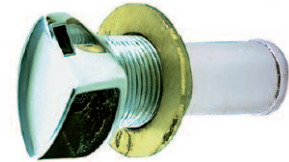

FIG. 509

### FIG. 503 - GAS TANK VENT

#### CONSTRUCTION:

- \* CHROME PLATED BRONZE
- \* REMOVABLE 30 MESH STAINLESS STEEL WIRE SCREEN FLAME ARRESTER



#### ORDERING INFORMATION

Thread Size Inches	Max. Hull Thickness Inches	Dealer Pkg. - 5 Cards 1 Pc. per Card	OEM Bulk Pkg. 50 Pcs.	Weight Ounces
3/8	7/8	503 DP3 CHR	503 003 CHR	5-1/2
1/2	7/8	503 DP4 CHR	503 004 CHR	6



FIG. 503

### FIG. 515 - GAS TANK VENT

#### CONSTRUCTION:

- \* CHROME PLATED BRONZE
- \* REMOVABLE 30 MESH STAINLESS STEEL WIRE SCREEN FLAME ARRESTER



#### ORDERING INFORMATION

Thread Size Inches	Max. Hull Thickness Inches	Dealer Pkg. - 5 Cards 1 Pc. per Card	OEM Bulk Pkg. 50 Pcs.	Weight Ounces
3/8	5/8	515 DP3 CHR	515 003 CHR	3
1/2	5/8	515 DP4 CHR	515 004 CHR	4

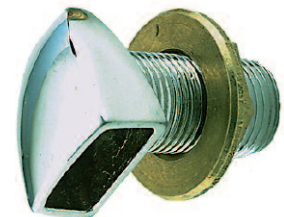

FIG. 515

### FIG. 505 - GAS TANK VENT

#### CONSTRUCTION:

- \* CHROME PLATED CAST BRONZE
- \* REMOVABLE 30 MESH STAINLESS STEEL WIRE SCREEN FLAME ARRESTER

Designed to meet the requirements of the National Fire Protection Association Booklet No. 302, Section No. 323 on vent pipe outlets. The 1/2 inch N.P.T. is off center to create a water baffle.



#### ORDERING INFORMATION

O.D. Flange Inches	O.D. Neck Inches	Length Neck Inches	Dealer Pkg 5 Cards 1 Pc. per Card	OEM Bulk Pkg. 25 Pcs.	Screw Size	Weight Ounces
2-1/2	1-3/16	1-1/2	505 DP CHR	505 000 CHR	8	6-1/2



FIG. 505

**Note: All of the Above Vents are Designed to Meet the Requirements of U.S.C.G. Safety Standards January 31, 1977, for Gasoline Fuel Systems 33CFR183.**

## DECK PLATE KEYS & CABLE

**FIG. 1247 - DECK PLATE KEY**



**Fig. 1247**

**CONSTRUCTION:**

**\* BLACK PLASTIC**

Compact Size with Hole for Key Chain.  
Will Fit PERKO 1-1/4" and 1-1/2" Deck Plates  
and Many Other "Slot" Type Opening Deck Plates.



**ORDERING INFORMATION**

C. to C. of Lugs	Length Spade Inches	Length Overall Inches	Dealer Pkg. 10 Cards 1 Pc. per Card	OEM Bulk Pkg. 50 Pcs.	Weight Ounces
1-1/8	1	1-3/4	1247 DP BLK	1247 000 BLK	1



**FIG. 1248 - DECK PLATE KEY**

**CONSTRUCTION OPTIONS:**

**\* BLACK PLASTIC OR ZINC ALLOY**

The Keys For 1" Thru 1-1/2" Deck Plates Have a 1 Inch Spade on Handle That Allows Them to Fit Many Other "Slot" Type Opening Deck Plates.



**Fig. 1248**



**ORDERING INFORMATION**

For Deck Plate Size Inches	C. to C. of Lugs	Length Overall Inches	Material	Dealer Pkg. 10 Cards 1 Pc. per Card	Standard Pkg. - 10 Pcs.	Weight Ounces
1	5/8	3-3/8	Plastic	1248 006 DP	-----	1/2
1-1/4 & 1-1/2	1-1/8	3-3/8	Plastic	1248 7-8 DP	1248 7-8 BLK	1/2
2	1-11/16	4-3/8	Zinc	1248 009 DP	-----	2-1/2
2-1/2	2	4-3/8	Zinc	-----	*1248 010 ZNC	2-1/2

\*Standard Pkg. - 1 pc.

**FIG. 826 - ADJUSTABLE DECK PLATE KEY**

**CONSTRUCTION:**

**\* CHROME PLATED ZINC ALLOY**

**\* HARDENED STEEL PIN**

**\* WILL FIT SIZES UP TO 8 INCH DIAMETER**



**Fig. 826**

**ORDERING INFORMATION**

Length Overall Inches	Dealer Pkg. - 5 Cards 1 Pc. per Card	Weight Ounces
8-1/2	826 DP CHR	9-1/2

**FIG. 537 - RETAINING CABLE FOR DECK PLATES**

**CONSTRUCTION:**

**\* STAINLESS STEEL CABLE AND FITTINGS**

**\* STAINLESS STEEL RING AND SELF TAPPING SCREW.**



**Fig. 537**

**ORDERING INFORMATION**

Ring Diameter Inches	Fill Hose Size Inches	Length Cable Inches	Dealer Pkg. - 5 Cards 1 Pc. per Card	Weight Ounces
1-3/8	1-1/2	7	537 DP	1/2
2	2	7	537 DP2	1/2



## CLEATS

**FIG. 566 - CLOSED BASE CLEAT**

**CONSTRUCTION:**

**\* CHROME PLATED ZINC ALLOY**



**FIG. 566**



**ORDERING INFORMATION**

Length Overall Inches	Dimensions Base Inches	Max. Rope Size Inches	Dealer Pkg. - 5 Cards 2 Pcs. per Card	Screw Size	Weight Ounces
2	2-3/16 x 1-1/8	5/16	566 DP2 CHR	6	1-1/2
3	3-1/8 x 1-1/2	3/8	566 DP3 CHR	8	4-1/2
4-1/2	4-7/16 x 1-7/8	1/2	566 DP4 CHR	10	8-1/2

**FIG. 1252 - OPEN BASE CLEAT**

**CONSTRUCTION:**

**\* CHROME PLATED ZINC ALLOY**



**FIG. 1252**



**ORDERING INFORMATION**

Length Overall Inches	Dimensions Base Inches	Max. Rope Size Inches	Dealer Pkg. 5 Cards 2 Pcs. per Card	OEM Bulk Pkg. 50 Pcs.	Screw Size	Weight Ounces
6-1/2	3 x 1-1/8	3/4	1252 DP CHR	1252 000 CHR	1/4	7

**FIG. 530 - OPEN BASE CLEAT**

**CONSTRUCTION:**

**\* PLAIN ALUMINUM**



**FIG. 530**



**ORDERING INFORMATION**

Length Overall Inches	Dimensions Base Inches	Max. Rope Size Inches	Standard Package - 1 Pc.	Screw Size	Weight Pounds
8	4 x 2-1/4	3/4	530 008 ALU	1/2	1-1/8
10	4-1/2 x 3	7/8	530 010 ALU	1/2	1-3/4
12	6-1/2 x 2-7/8	1	530 012 ALU	5/8	3-1/2
15	7 x 3-1/4	1-1/2	530 015 ALU	3/4	4-7/8

## CLEATS



**Fig. 572**

**FIG. 572 - OPEN BASE CLEAT**

**CONSTRUCTION:**

\* **CHROME PLATED BRONZE**



**ORDERING INFORMATION**

Length Overall Inches	Dimensions Base Inches	Max. Rope Size Inches	Dealer Pkg. 5 Cards 1 Pc. per Card	Standard Package - 1 Pc.	OEM Bulk Pkg. 10 Pcs.	Screw Size	Weight Pounds
8	4 x 2-1/4	3/4	572 DP8 CHR	-----	572 008 CHR	1/4	1-1/4
10	5-1/16 x 2-13/16	7/8	-----	572 010 CHR	-----	5/16	1-3/4
12	6-1/16 x 2-7/8	1	-----	572 012 CHR	-----	5/16	2-1/2
15	7-3/8 x 3-5/8	1-1/2	-----	572 015 CHR	-----	3/8	7-1/4



**Fig. 1188**

**FIG. 1188 - OPEN BASE CLEAT**

**CONSTRUCTION:**

\* **CHROME PLATED ZINC ALLOY**



**ORDERING INFORMATION**

Length Overall Inches	Dimensions Base Inches	Max. Rope Size Inches	Dealer Pkg. - 5 Cards 1 Pc. per Card	Catalog Number	Std. Pkg.	OEM Bulk Pkg.	Screw Size	Weight Pounds
4	2-1/8 x 1-1/2	5/16	*1188 DP4 CHR	1188 004 CHR	---	50	10	1/4
6	3 x 1-3/4	7/16	1188 DP6 CHR	1188 006 CHR	---	50	10	1/2
8	4 x 2-1/8	5/8	1188 DP8 CHR	1188 008 CHR	---	25	1/4	3/4
12	6 x 3	1	-----	1188 012 CHR	1	10	5/16	2-1/2

\* Dealer Package, 5 cards - 2 Pcs. per card.

**FIG. 1210 - OPEN BASE CLEAT**



**Fig. 1210**

**CONSTRUCTION:**

\* **CHROME PLATED ZINC ALLOY**

\* **STAINLESS STEEL STUDS, NUTS AND WASHERS**



**ORDERING INFORMATION**

Length Overall Inches	Dimensions Base Inches	Max. Rope Size Inches	Catalog Number	Std. Pkg.	OEM Bulk Pkg.	Stud Size	Weight Ounces
4	2-1/8 x 1-1/2	5/16	1210 004 CHR	10	50	12-24 x 1-1/4	5-1/2
6	3 x 1-3/4	7/16	1210 006 CHR	10	30	1/4-20 x 2	8
8	4 x 2-1/8	5/8	1210 008 CHR	5	30	1/4-20 x 2	12-1/2

## CLEATS

**FIG. 545 - CLEAT**

**CONSTRUCTION:**

**\* PLAIN ALUMINUM**



**FIG. 545**



**ORDERING INFORMATION**

Length Overall Inches	Dimensions Base Inches	Max. Rope Size Inches	Dealer Pkg. 5 Cards 2 Pcs. per Card	OEM Bulk Package	OEM Bulk Pkg Pcs/Pkg	Screw Size	Weight Ounces
3	1-1/2 x 5/8	1/4	545 DP3 ALU	-----	---	8	1-1/2
4	1-5/8 x 3/4	5/16	545 DP4 ALU	-----	---	10	2
5	2 x 7/8	3/8	545 DP5 ALU	-----	---	1/4	3
6	2-1/4 x 7/8	7/16	**545 DP6 ALU	545 006 ALU	50	1/4	4
*8	2-5/8 x 1-7/8	5/8	**545 DP8 ALU	545 008 ALU	25	1/4	5
*10	3-5/8 x 1-1/2	3/4	-----	545 010 ALU	5	5/16	9
*12	4 x 1-1/2	7/8	-----	545 012 ALU	5	5/16	14

\* These Sizes are Open Base, Balance of Sizes are Closed Base.

\*\* Dealer Package, 10 pcs., 1 Pc. per card.

**FIG. 544 - CLEAT**

**CONSTRUCTION:**

**\* CAST BRONZE**

**\* POLISHED OR CHROME PLATED**



**FIG. 544**



**ORDERING INFORMATION**

Overall Inches	Base Inches	Size Inches.	Chrome Plated Bronze Dealer Pkg.	Pkg. - 5 Cards Pcs. per Card	Polished Bronze Standard Pkg.	Std. Pkg.	Screw Size
3	1-1/2 x 5/8	1/4	544 DP3 CHR	2	544 003 POL	10	8
4	1-5/8 x 3/4	5/16	544 DP4 CHR	1	544 004 POL	5	10

## CLEATS



**Fig. 1305**

**FIG. 1305 - CLOSED BASE CLEAT**

**CONSTRUCTION:**

- \* CHROME PLATED ZINC ALLOY
- \* BLACK PLASTIC BASE



**ORDERING INFORMATION**

Length Overall Inches	Max. Rope Size Inches	Dealer Package	Dealer Pkg. 5 Cards Pcs. per Card	OEM Bulk Pkg. 50 Pcs.	Screw Size	Weight Ounces
4-1/2	3/8	1305 DP1 CHR	2	1305 001 CHR	10	5
6	1/2	1305 DP2 CHR	1	1305 002 CHR	1/4	10

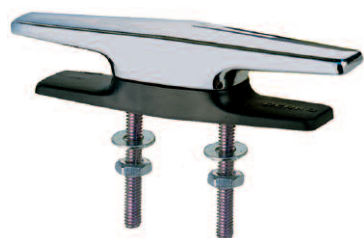

**Fig. 1315**

**FIG. 1315 - CLOSED BASE CLEAT**

**CONSTRUCTION:**

- \* CHROME PLATED ZINC ALLOY
- \* BLACK PLASTIC BASE
- \* STAINLESS STEEL STUDS, NUTS AND WASHERS

**ORDERING INFORMATION**

Length Overall Inches	Max. Rope Size Inches	Catalog Number	Standard Package	OEM Bulk Package	Stud Size	Weight Ounces
4-1/2	3/8	1315 001 CHR	10	50	12-24 x 1-1/2	6-1/2
6	1/2	1315 002 CHR	5	40	1/4 x 1-1/2	12



**Fig. 1316**

**FIG. 1316 - OPEN BASE CLEAT**

**CONSTRUCTION:**

- \* CHROME PLATED ZINC ALLOY
- \* BLACK PLASTIC BASE
- \* STAINLESS STEEL STUDS, NUTS AND WASHERS

**ORDERING INFORMATION**

Length Overall Inches	Max. Rope Size Inches	Catalog Number	Std. Pkg.	OEM Bulk Pkg.	Stud Size	Weight Ounces
4-1/2	3/8	1316 001 CHR	10	50	12-24 x 1-1/2	5
6	1/2	1316 002 CHR	5	40	1/4 x 1-1/2	10-1/2



**Fig. 1416**

**FIG. 1416 - OPEN BASE CLEAT**

**CONSTRUCTION:**

- \* CHROME PLATED ZINC ALLOY
- \* BLACK PLASTIC BASE AND INSERT
- \* STAINLESS STEEL STUDS, NUTS AND WASHERS

**ORDERING INFORMATION**

Length Overall Inches	Max. Rope Size Inches	Catalog Number	Std. Pkg.	OEM Bulk Pkg.	Stud Size	Weight Ounces
4-1/2	3/8	1416 001 CHR	10	50	12-24 x 1-1/2	5
6	1/2	1416 002 CHR	5	40	1/4 x 1-1/2	10-1/2



## CLEATS

**FIG. 1306 - OPEN BASE CLEAT**

**CONSTRUCTION:**

- \* CHROME PLATED ZINC ALLOY
- \* BLACK PLASTIC BASE



**ORDERING INFORMATION**

Length Overall Inches	Max. Rope Size Inches	Dealer Package	Dealer Pkg. 5 Cards Pcs. per Card	OEM Bulk Pkg. 50 Pcs.	Screw Size	Weight Ounces
4-1/2	3/8	1306 DP1 CHR	2	1306 001 CHR	10	4
6	1/2	1306 DP2 CHR	1	1306 002 CHR	1/4	8-1/2



**FIG. 1306**

**FIG. 1406 - OPEN BASE CLEAT**

**CONSTRUCTION:**

- \* CHROME PLATED ZINC ALLOY
- \* BLACK PLASTIC BASE AND INSERT



**ORDERING INFORMATION**

Length Overall Inches	Max. Rope Size Inches	Dealer Package	Dealer Pkg. 5 Cards Pcs. per Card	OEM Bulk Pkg. 50 Pcs.	Screw Size	Weight Ounces
4-1/2	3/8	1406 DP1 CHR	2	1406 001 CHR	10	4
6	1/2	1406 DP2 CHR	1	1406 002 CHR	1/4	8-1/2
8	3/4	-----	---	*1406 003 CHR	1/4	11



**FIG. 1406**

\*Std Pk 1 pc.

**FIG. 1326 - OPEN BASE CLEAT**

**CONSTRUCTION:**

- \* CHROME PLATED ZINC ALLOY
- \* BLACK PLASTIC BASE



**ORDERING INFORMATION**

Length Overall Inches	Dimensions Base Inches	Max. Rope Size Inches	Dealer Pkg. 5 Cards 1 Pc. per Card	OEM Bulk Pkg. 50 Pcs.	Screw Size	Weight Ounces
5-3/4	3-5/8 x 7/8	1/2	1326 DP2 CHR	1326 002 CHR	1/4	9



**FIG. 1326**

**FIG. 573 - OPEN BASE CLEAT**

**CONSTRUCTION:**

- \* CHROME PLATED BRONZE
- \* BLACK PLASTIC BASE



**ORDERING INFORMATION**

Length Overall Inches	Dimensions Base Inches	Max. Rope Size Inches	Dealer Pkg. 5 Cards 1 Pc. per Card	OEM Bulk Pkg. 50 Pcs.	Screw Size	Weight Ounces
6	3-5/8 x 7/8	1/2	573 DP6 CHR	573 006 CHR	1/4	9



**FIG. 573**

## CHOCKS



**FIG. 119 - STRAIGHT CHOCK**

**CONSTRUCTION:**

\* **CHROME PLATED BRONZE**



**FIG. 119**



**ORDERING INFORMATION**

Max. Rope Size Inches	Length Overall Inches	Width Inches	Dealer Pkg 5 Cards 1 Pair per Card	OEM Bulk Pkg. 10 Pair	Screw Size	Weight per Pair Ounces
3/4	4	7/8	119 DP4 CHR	119 004 CHR	8	4
1	6	1-1/8	119 DP6 CHR	-----	12	12

**FIG. 1230 - STRAIGHT CHOCKS**



**FIG. 1230**

**CONSTRUCTION:**

\* **CHROME PLATED ZINC ALLOY**



**ORDERING INFORMATION**

Max. Rope Size Inches	Length Overall Inches	Width Inches	Dealer Pkg 10 Cards 1 Pair per Card	OEM Bulk Pkg. 50 Pair	Screw Size	Weight per Pair Ounces
3/4	4	7/8	1230 DP CHR	1230 000 CHR	8	6

**FIG. 1223 - SKENE BOW CHOCKS**



**FIG. 1223**

**CONSTRUCTION:**

\* **CHROME PLATED ZINC ALLOY**



**ORDERING INFORMATION**

Max. Rope Size Inches	Length Overall Inches	Width Inches	Dealer Pkg 5 Cards 1 Pair per Card	OEM Bulk Pkg. 50 Pair	Screw Size	Weight per Pair Ounces
1/2	3-1/2	7/8	1223 DP CHR	1223 000 CHR	8	4

## MOORING BIT, HAWSE HOLE PLATE & LIFTING EYE

**FIG. 608 - MOORING BITT**

**CONSTRUCTION:**

\* **CHROME PLATED BRONZE, HOLLOW**

**ORDERING INFORMATION**

Dimensions Base Inches	Height Inches	Standard Pkg. 1 Pc.	Bolt Size	Weight Pounds
4-1/4 x 4-1/4	3-1/2	608 002 CHR	1/4	1-7/8
5 x 5	4-3/4	608 02A CHR	3/8	3-1/2
6 x 6	5	608 003 CHR	3/8	4-1/2



**FIG. 608**

**FIG. 434 - LIFTING EYE AND CLEAT**

**CONSTRUCTION:**

\* **CHROME PLATED MANGANESE BRONZE**  
**SAFE WORKING LOAD 4000 POUNDS**



**ORDERING INFORMATION**

For Rod Threaded Inches	I.D. Eye Inches	Length Overall Inches	Dimensions Base Inches	Dealer Pkg. 5 Cards 1 Pc. per Card	OEM Bulk Pkg 10Pcs.	Screw Size	Weight Ounces
5/8 x 11	1-1/16	5-1/16	3-1/2 x 2-1/2	434 DP CHR	434 000 CHR	10	18



**FIG. 434**

**FIG. 429 - LIFTING EYE**

**CONSTRUCTION:**

\* **CHROME PLATED MANGANESE BRONZE, INTEGRAL FLANGE**  
**SAFE WORKING LOAD 3000 POUNDS\***

**ORDERING INFORMATION**

For Rod Threaded Inches	I.D. Eye Inches	O.D. Eye Inches	O.D. Base Inches	Standard Pkg. - 1 Pc.	Screw Size	Weight Ounces
5/8 x 11	1-1/2	2-1/4	2-1/4	429 000 CHR	8	19



**FIG. 429**

**FIG. 752 - HAWSE HOLE PLATE**

**CONSTRUCTION:**

\* **CHROME PLATED BRONZE**

**ORDERING INFORMATION**

Dimensions Outside Inches	Dimensions Inside Inches	Length Spigot Inches	Std. Pkg. - 1 Pc. OEM Pkg. - 10 Pcs.	Screw Size	Weight Pounds
4-1/4 x 6	2-1/8 x 4-1/8	1-1/4	752 000 CHR	1/4	1-1/2



**FIG. 752**

**\*IMPORTANT NOTE: THE SAFE WORKING LOAD INFORMATION GIVEN FOR THE ITEMS ABOVE IS BASED ON A STRAIGHT AXIAL PULL. THIS INFORMATION WOULD NOT APPLY IN CASES WHERE INSTALLATION OR USE CREATES ANGULAR LOADING SINCE THESE VARIATIONS MAKE IT IMPRACTICABLE TO OFFER ACCURATE TEST DATA.**

## DECK PIPES

### FIG. 750 - ROPE AND CHAIN DECK PIPE

**CONSTRUCTION:**

- \* **CHROME PLATED BRONZE**

The Cover Has a Hook for Hanging Chain and a Stainless Steel Cable Retainer.



**Fig. 750**

**ORDERING INFORMATION**

Opening For Chain Size Inches	Dimensions Flange Inches	Height Overall Inches	Dealer Pkg. - 5 Cards 1 Pc. per Card	Screw Size	Weight Pounds
3/8	5-1/4 x 4	1-3/8	750 DP CHR	8	2

Spare Cover with Hook and Cable, Cat. No. 750 DP 99A

### FIG. 1057 - ROPE DECK PIPE

**CONSTRUCTION:**

- \* **HIGH IMPACT BLACK OR WHITE PLASTIC**
- \* **U.V. STABILIZED, FIBER REINFORCED**
- \* **HINGED, SNAP-DOWN COVER**



**Fig. 1057 WHT**



**Fig. 1057 BLK**

**ORDERING INFORMATION**

Color	Maximum Rope Size Inches	O.D. Flange Inches	Dealer Pkg. 5 Cards 1 Pc. per Card	OEM Bulk Pkg. 25 Pcs.	Screw Size	Weight Ounces
Black	7/8	3-3/4	1057 DP BLK	1057 000 BLK	8	3-1/4
White	7/8	3-3/4	1057 DP WHT	1057 000 WHT	8	3-1/4

### FIG. 741 - ROPE DECK PIPE

**CONSTRUCTION:**

- \* **CHROME PLATED BRONZE**



**Fig. 741**

**ORDERING INFORMATION**

Maximum Rope Size Inches	O.D. Flange Inches	Dealer Pkg. 5 Cards 1 Pc. per Card	OEM Bulk Pkg. 10 Pcs.	Screw Size	Weight Pounds
5/8	3	741 DP0 CHR	741 000 CHR	8	3/4

Spare No. 0 Cap with Chain, Cat. No. 741 DP0 99A.

### FIG. 757 - ROPE DECK PIPE

**CONSTRUCTION:**

- \* **CHROME PLATED ZINC ALLOY**



**Fig. 757**

**ORDERING INFORMATION**

Maximum Rope Size Inches	O.D. Flange Inches	Dealer Pkg. 5 Cards 1 Pc. per Card	OEM Bulk Pkg. 10 Pcs.	Screw Size	Weight Pounds
1	3-3/8	757 DP CHR	757 000 CHR	8	1/2

## ANCHOR CHOCKS & RIGGING TUBE

### CONSTRUCTION:

\* **CHROME PLATED BRONZE, POLISHED OR BURNISHED**

Size No. 1 Fits	
<b>Fortress Models</b> FX7-FX16	<b>Danforth® Models</b> H®500      T™570 H®960      T™1200 H®1500     T™1800 S®160      T™2500 S®300      T™3000
<b>U.S. Anchor Mfg., INC. Models</b> 2-1/2, 4, 8, 13	S®600      D™375 S®920      D™750 S®1300     D™1150 VSB™160   D™1650 VSB™13000 VSB™1900
Size No. 2 Fits	
<b>Fortress Models</b> FX23-FX55	<b>Danforth® Models</b> H®1800     T™4000 H®3100     T™6000 H®3600     T™7000 D™2000 D™2500
<b>U.S. Anchor Mfg., INC. Models</b> 18 & 22	S®1600 S®2000 S®3000 VSB™2500 VSB™3600



FIG. 903



ORDERING INFORMATION			
Polished Chrome Plated Bronze	Burnished Chrome Plated Bronze	Screw Size	Weight Per Set Pounds
Dealer Pkg. - 5 Cards 1 Set per Card	Dealer Pkg. - 5 Cards 1 Set per Card		
903 DP1 CHR	903 DP1 BUR	10	2
903 DP2 CHR	903 DP2 BUR	10	2-1/4



New Clam Shell Package

### SPARE PARTS ORDERING INFORMATION

To Specify Size Replace the Sixth Digit With the Size Number (i.e. 903 001 99A or 903 B01 99A).

Spare Polished Chrome Shank Support, Cat. No. 903 000 99A.  
Spare Pair, Polished Chrome Fluke Supports, Cat. No. 903 000 99B.  
Spare Polished Chrome Crown Support, Cat. No. 903 000 99C.  
Spare Knob, Cat. No. 1144 A00 BLK.

Spare Burnished Chrome Shank Support, Cat. No. 903 B00 99A.  
Spare Pair, Burnished Chrome Fluke Supports, Cat. No. 903 B00 99B.  
Spare Burnished Chrome Crown Support, Cat. No. 903 B00 99C.

### FIG. 357 - RIGGING TUBE

#### CONSTRUCTION:

\* **CHROME PLATED BRASS AND BRONZE**

For use with 2 Inch I.D. Hose to Pass Wiring Harnesses and Control Cables Through Transoms and Motorwell Bulkheads.  
Mounts in 2-1/8 Inch Diameter Hole.



ORDERING INFORMATION						
O.D. Tube Inches	Length Overall Inches	O.D. Flange Inches	Dealer Pkg. 5 Cards 1 Pc. per Card	OEM Bulk Pkg. 25 Pcs.	Screw Size	Weight Ounces
2	4-1/8	3-1/8	357 DP1 CHR	357 001 CHR	8	12



FIG. 357

## Bow & Transom Eyes

**NOTE: THE BOW EYES AND TRANSOM EYES ILLUSTRATED ON THIS PAGE ARE NOT DESIGNED TO BEAR THE WEIGHT OF THE VESSEL AND THEREFORE SHOULD NOT BE USED FOR LIFTING.**

**FIG. 237 - Bow Eye**

**CONSTRUCTION:**

- \* **NON-MAGNETIC 300 SERIES STAINLESS STEEL SHANK**
- \* **STAINLESS STEEL NUTS & WASHERS**

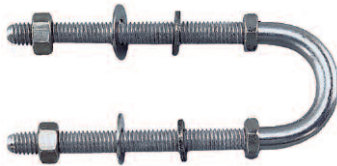

**FIG. 237**

**ORDERING INFORMATION**

Length Shank Inches	O.D. Shank Inches	I.D. Eye Inches	Length Thread Inches	Dealer Pkg. 10 Cards 1 Pc. per Card	Weight Ounces	Safe Working Load Pounds
3	5/16	1	3	237 DP1 STS	4	1800
6	5/16	1	6	237 DP2 STS	5-1/2	1800
3	3/8	1-1/8	3	*237 DP3 STS	5	3000
3-1/4	1/2	1-1/2	3-1/4	*237 DP4 STS	12	4600

\* Dealer Pkg., 5 cards, 1 Pc. per card

**FIG. 1235 - Bow Eye**

**CONSTRUCTION:**

- \* **CHROME PLATED ZINC ALLOY EYE**
- \* **ZINC ALLOY PLATED STEEL "U" BOLT, NUTS & WASHERS**

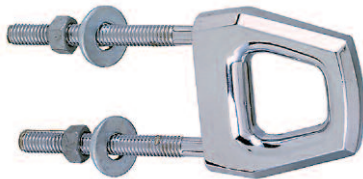

**FIG. 1235**

**SAFE WORKING LOAD 2000 POUNDS\***

**ORDERING INFORMATION**

Length Shank Inches	O.D. Shank Inches	I.D. Eye Inches	Length Thread Inches	Dealer Pkg. - 10 Cards 1 Pc. per Card	Weight Ounces
3	5/16	1	2-3/4	1235 DP CHR	11

**FIG. 236 - TRANSOM EYE FOR USE AS TOWING OR LASHING EYE.**

**CONSTRUCTION:**

- \* **NON-MAGNETIC 300 SERIES STAINLESS STEEL SHANK**
- \* **STAINLESS STEEL FINISHING PLATE, NUTS & WASHERS**

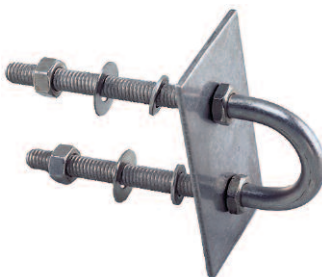

**FIG. 236**

**ORDERING INFORMATION**

Length Shank Inches	O.D. Shank Inches	I.D. Eye Inches	Dimensions Plate Inches	Dealer Pkg. 5 Cards 1 Pc. per Card	Weight Ounces	Safe Working Load Pounds
3	5/16	1	3 x 1-3/4	*236 DP1 STS	6	1800
3	3/8	1-1/8	3 x 1-3/4	236 DP3 STS	10	3000
3-1/4	1/2	1-1/2	4 x 1-3/4	236 DP4 STS	14-1/2	4600

\* Dealer Pkg., 10 cards, 1 Pc. per card

**\*IMPORTANT NOTE: THE SAFE WORKING LOAD INFORMATION GIVEN FOR THE ITEMS ABOVE IS BASED ON A STRAIGHT AXIAL PULL. THIS INFORMATION WOULD NOT APPLY IN CASES WHERE INSTALLATION OR USE CREATES ANGULAR LOADING SINCE THESE VARIATIONS MAKE IT IMPRACTICABLE TO OFFER ACCURATE TEST DATA.**

## STEP PLATES & STEPS

### 1043/1325 STEP PLATES

#### CONSTRUCTION:

\* **SOFT BLACK PLASTIC PADS**

**FIG. 1043 - CHROME PLATED BRONZE FRAMES**

**FIG. 1325 - CHROME PLATED ZINC ALLOY FRAMES**



#### ORDERING INFORMATION

Dimensions Inches	Dealer Pkg. - 5 Cards 1 Pcs. per Card	OEM Bulk Pkg. 50 Pcs.	Screw Size	Weight Ounces
8-3/4 x 3-1/4	1043 DP1 CHR	-----	6	8
11-1/2 x 5-3/4	1043 DP2 CHR	-----	8	12
8-3/8 x 2-1/4	*1325 DP0 CHR	1325 000 CHR	8	5
8-3/4 x 3-1/4	*1325 DP1 CHR	1325 001 CHR	8	8

\* Dealer Package 2 Pcs. per card.

Spare Pads for Size No. 0 (2 per bag), Cat. No. 1050 DP0 BLK.

Spare Pads for Size No. 1 (2 per bag), Cat. No. 1050 DP1 BLK.

Spare Pads for Size No. 2 (2 per bag), Cat. No. 1050 DP2 BLK.



**FIG. 1043**



**FIG. 1325**

### FIG. 1015 - STEP PLATE

#### CONSTRUCTION:

\* **CHROME PLATED BRASS FRAME**

\* **SOFT BLACK PLASTIC TREAD INSERT**



#### ORDERING INFORMATION

Dimensions Inches	Dealer Pkg. - 5 Cards 2 Pcs. per Card	O.E.M. Bulk Pkg. 50 Pcs.	Screw Size	Weight Ounces
7-1/4 x 1-1/2	1015 DP CHR	1015 000 CHR	8	2



**FIG. 1015**

### FIG. 351 & 501 - FIXED STEPS

#### CONSTRUCTION:

\* **CHROME PLATED BRONZE**



#### ORDERING INFORMATION

Dimensions Step Inches	Dimensions Bracket Inches	Dealer Pkg. 5 Cards 1 Pc. per Card	Standard Package - 1 Pc.	Bolt Size	Weight Pounds
6 x 4-1/4	6 x 2	351 DP CHR	-----	5/16 R.H.	1-1/8
11 x 4-1/2	11 x 2	-----	501 000 CHR	5/16 R.H.	2-7/8

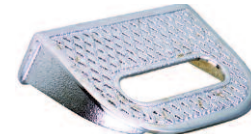

**FIG. 351**



**FIG. 501**

### FIG. 344 - FOLDING STEPS

#### CONSTRUCTION:

\* **CHROME PLATED BRONZE**

**STAINLESS STEEL SPRING HOLDS STEPS  
IN OPEN OR CLOSED POSITION**



#### ORDERING INFORMATION

Dimensions Step Inches	Dimensions Bracket Inches	Projection Folded Inches	Dealer Pkg. 5 Cards 1 Pc. per Card	Bolt Size	Weight Pounds
4-1/8 x 2-1/4	4-1/4 x 1-3/4	1-3/8	344 DP CHR	5/16 R.H.	1-1/2

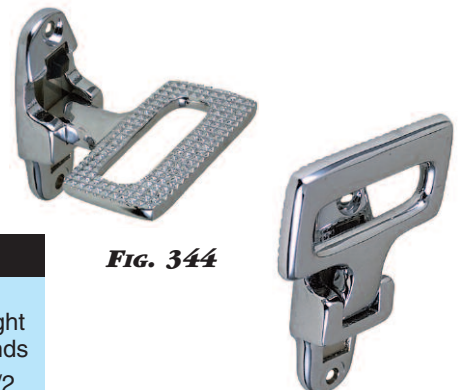

**FIG. 344**

## FLAG POLE SOCKETS & FLAG STAFF

**FIG. 219**  
**STERN**



### FIG. 218 & 219 - FLUSH FLAG POLE SOCKETS

**CONSTRUCTION:**

\* **CHROME PLATED BRONZE**

**FIG. 218 - BOW SOCKET**

**FIG. 219 - STERN SOCKET, 26° ANGLE**



**FIG. 218**  
**Bow**

**ORDERING INFORMATION**

I.D. Socket Inches	O.D. Flange Inches	Depth Socket Inches	Fig. 218 Dealer Pkg. - 5 Cards 1 Pc. per Card	Fig. 219 Dealer Pkg. - 5 Cards 1 Pc. per Card	Screw Size	Weight Ounces
3/4	2	1-1/2	218 DP1 CHR	219 DP1 CHR	8	4-1/2
1	2-3/8	1-3/4	218 DP2 CHR	219 DP2 CHR	8	5
1-1/4	2-5/8	2	218 DP3 CHR	219 DP3 CHR	8	9

### FIG. 220 & 221 - UPRIGHT FLAG POLE SOCKETS

**FIG. 220**  
**Bow**



**CONSTRUCTION:**

\* **CHROME PLATED BRONZE**

**FIG. 220 - BOW SOCKET**

**FIG. 221 - STERN SOCKET, 13° ANGLE**



**FIG. 221**  
**STERN**

**ORDERING INFORMATION**

I.D. Socket Inches	O.D. Base Inches	Height Overall Inches	Fig. 220 Dealer Pkg. - 5 Cards 1 Pc. per Card	Fig. 221 Dealer Pkg. - 5 Cards 1 Pc. per Card	Screw Size	Weight Ounces
3/4	2-1/8	1-3/4	220 DP1 CHR	221 DP1 CHR	8	5-1/4
1	2-1/2	2	220 DP2 CHR	221 DP2 CHR	8	6-3/4
1-1/4	2-3/4	2-1/8	220 DP3 CHR	221 DP3 CHR	8	10-3/4

### FIG. 1302 - CLAMP-ON FLAG POLE SOCKET

**CONSTRUCTION:**

\* **CHROME PLATED ZINC ALLOY**

\* **BLACK PLASTIC KNOB**

For Rail Sizes 3/4 to 1 Inch



**FIG. 1302**



**ORDERING INFORMATION**

I.D. Socket Inches	Dimensions Bracket Inches	Dealer Pkg. - 5 Cards 1 Pc. per Card	Weight Ounces
3/4	2 x 1-3/4	1302 DP CHR	11

### FIG. 495 - FLAG STAFF

**CONSTRUCTION:**

\* **CHROME PLATED ZINC ALLOY BASE AND TOP**

\* **ANODIZED ALUMINUM TUBE**

Sizes 2 and 3 For Use With

Fig. 1302 Clamp-On Socket Only



**ORDERING INFORMATION**

O.D. Base Inches	Length Overall Inches	Dealer Pkg. - 5 Bags 1 Pc. per Bag	Weight Ounces
1/2	14	495 DP1 CHR	3
3/4	14	495 DP2 CHR	4
3/4	18	495 DP3 CHR	5

**FIG. 495**





## HANDLES

**FIG. 1336 - HANDLES**

**CONSTRUCTION:**

- \* CHROME PLATED ZINC ALLOY
- \* BLACK PLASTIC BASE



**ORDERING INFORMATION**

Length Overall Inches	Length Inside Inches	Height Inside Inches	Dealer Pkg. 5 Cards 2 Pcs. per Card	OEM Bulk Pkg. 50 Pcs.	Screw Size	Weight Ounces
6-1/4	3-1/2	1	1336 DP CHR	1336 000 CHR	1/4	10



**FIG. 1336**

**FIG. 1346 - HANDLES**

**CONSTRUCTION:**

- \* CHROME PLATED ZINC ALLOY
- \* BLACK PLASTIC BASE
- \* STAINLESS STEEL STUDS, NUTS AND WASHERS



**ORDERING INFORMATION**

Length Overall Inches	Length Inside Inches	Height Inside Inches	Std. Pkg. - 10 Pcs. OEM Bulk Pkg. - 50 Pcs.	Stud Size	Weight Ounces
6-1/4	3-1/2	1	1346 000 CHR	1/4 - 20 x 1-1/2	11



**FIG. 1346**

**FIG. 1222 - HANDLE**

**CONSTRUCTION:**

- \* CHROME PLATED ZINC ALLOY



**ORDERING INFORMATION**

Length Overall Inches	Length Inside Inches	Height Inside Inches	Dealer Pkg. 5 Cards 2 pcs. per Card	OEM Bulk Pkg. 100 Pcs.	Screw Size	Weight Ounces
5-3/4	3-5/8	1-1/4	1222 DP CHR	1222 000 CHR	8	3-1/2



**FIG. 1222**

**FIG. 1231 - HANDLE**

**CONSTRUCTION:**

- \* CHROME PLATED ZINC ALLOY



**ORDERING INFORMATION**

Length Overall Inches	Length Inside Inches	Height Inside Inches	Dealer Pkg. 5 Cards 2 pcs. per Card	OEM Bulk Pkg. 50 Pcs.	Screw Size	Weight Ounces
6	3-1/2	1-5/16	1231 DP CHR	1231 000 CHR	1/4	7-1/4



**FIG. 1231**

**FIG. 775 - HANDLE**

**CONSTRUCTION:**

- \* CHROME PLATED BRONZE



**ORDERING INFORMATION**

Length Overall Inches	Length Inside Inches	Height Inside Inches	Dealer Pkg. 5 Cards 2 pcs. per Card	OEM Bulk Pkg. 50 Pcs.	Screw Size	Weight Ounces
4-1/4	2-1/2	7/8	775 DP1 CHR	775 001 CHR	6	2
5-3/4	3-5/8	1-3/8	775 DP2 CHR	775 002 CHR	8	4



**FIG. 775**

## HANDLE, GRAB RAIL & POSTS, WOOD GUARD RAIL FITTINGS

**FIG. 1234 - BOW HANDLE FOR DAYSAILERS**

**REINSTATED**



**FIG. 1234**

**CONSTRUCTION:**

- \* CHROME PLATED ZINC ALLOY



**ORDERING INFORMATION**

Length Overall Inches	Height Above Deck Inches	Dealer Pkg. 5 Cards 2 Pcs. per Card	OEM Bulk Pkg. 50 Pcs.	Screw Size	Weight Ounces
6-1/2	2	1234 DP CHR	1234 000 CHR	8	5-1/2

**FIG. 491 - GRAB RAIL**



**FIG. 491**

**CONSTRUCTION:**

- \* CHROME PLATED ZINC ALLOY END POSTS
- \* POLISHED 18-8 STAINLESS STEEL TUBE



**ORDERING INFORMATION**

Length Overall Inches	Length Inside Inches	Height Inside Inches	Dealer Pkg. - 5 Cards 1 pc. per Card	Screw Size	Weight Pounds
9-1/2	7	3/4	491 DP1 CHR	6	3/4
15-5/8	13	3/4	491 DP2 CHR	6	1

**FIGS. 380, 380A & 1297 - GRAB RAIL POSTS**



**FIG. 380  
END POST**



**FIG. 380A  
CENTER POST**

**CONSTRUCTION:**

- \* HOLLOW, FOR 3/4 INCH O.D. TUBING
- \* CHROME PLATED BRONZE
- \* CHROME PLATED ZINC ALLOY

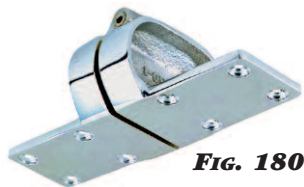

**FIG. 1297 END POST**

**ORDERING INFORMATION**

Height Overall Inches	O.D. Base Inches	Fig. 380 & 380A Standard Pkg. - 1 Pc.	Fig. 1297 Standard Pkg. - 4 Pcs.	Screw Size	Weight Ounces
3-3/8	2-1/2	380 000 CHR		8	10
3-3/8	2-1/2	380 A00 CHR		8	10
1-3/4	1-5/8	-----	1297 000 CHR	6	2-3/4

**FIG. 180 & 185 - FITTINGS FOR WOOD GUARD RAILS**



**FIG. 180**

**CONSTRUCTION:**

- \* CHROME PLATED BRONZE
- HINGE - FIG. 180
- LATCH - FIG. 185

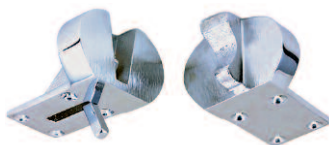

**FIG. 185**

**ORDERING INFORMATION**

For Rail Dimensions Inches	Length Overall Inches	Fig. 180 Standard Pkg. - 1 Pc.	Fig. 185 Standard Pkg. - 1 Pc.	Screw Size	Weight Pounds
2-3/8 x 1-3/8	5	180 001 CHR	185 001 CHR	8	3/4

## AXE BRACKET, RING BUOY HOLDER & EYE STRAPS

**FIG. 325 - AXE BRACKETS**

**CONSTRUCTION:**

\* **STAINLESS STEEL**



**ORDERING INFORMATION**

For Blade Width Inches	Standard Pkg. - 10 sets	Socket Screw Size	Bracket Screw Size	Weight per Set Ounces
6	325 000 STS	10 R.H.	6	4-1/2



**FIG. 325**

**FIG. 1017 - RING BUOY HOLDER**

**CONSTRUCTION OPTIONS:**

\* **CHROME PLATED BRASS**

\* **PLAIN BRASS**



**ORDERING INFORMATION**

Width Mounting Plate Inches	Height Overall Inches	Chrome Plated Brass Dealer Pkg. - 5 Cards 1 Pc. per Card	Plain Brass Standard Pkg. - 5 Pcs.	Screw Size	Weight Pounds
3	4-1/2	1017 DP CHR	1017 000 PLB	8	1/2



**FIG. 1017**

**FIG. 1242 - EYE STRAP**

**CONSTRUCTION:**

\* **CHROME PLATED ZINC ALLOY**



**ORDERING INFORMATION**

Length Overall Inches	I.D. Eye Inches	Dealer Pkg. - 10 Cards 5 Pcs. per Card	OEM Bulk Pkg. 100 Pcs.	Screw Size	Weight Ounces
1-7/8	5/16	1242 DP CHR	1242 000 CHR	8	1/4



**FIG. 1242**



**FIG. 562 - EYE STRAP**

**CONSTRUCTION:**

\* **300 SERIES STAINLESS STEEL**



**ORDERING INFORMATION**

Length Overall Inches	I.D. Eye Inches	Dealer Pkg. - 10 Cards 5 Pcs. per Card	OEM Bulk Pkg. 100 Pcs.	Screw Size	Weight Ounces
1-5/8	1/4	562 DP STS	562 000 STS	10 R.H.	1/8



**FIG. 562**



## BOAT HOOK HOLDERS, POLE STORAGE CLIPS & SPRING CLAMPS

**FIG. 492 - BOAT HOOK HOLDERS**



**Fig. 492**

**CONSTRUCTION:**

\* **STAINLESS STEEL**



**ORDERING INFORMATION**

Maximum Pole O.D. Inches	Length Inches	Width Inches	Dealer Pkg. 10 Cards 1 Pair per Card	OEM Bulk Pkg. 50 Pair	Screw Size	Weight Per Pair Ounces
1-1/2	3-1/2	1	492 DP STS	492 000 STS	6	1-1/2



**FIG. 477 - POLE STORAGE CLIPS**



**Fig. 477**

**CONSTRUCTION:**

\* **SOFT BLACK PLASTIC**

\* **FITS 3/4 INCH DIAMETER TUBING**

\* **U.V. STABILIZED**



**ORDERING INFORMATION**

For Pole O.D. Inches	Dimensions Inches	Dealer Pkg. 10 Cards 1 Pair per Card	OEM Bulk Pkg. 50 Pair	Screw Size	Weight per Pair Ounces
3/4	3/4 x 2-1/4 x 1-5/8	477 DP BLK	477 000 BLK	10 P.H.	3



**FIG. 502 - SPRING CLAMPS**



**Fig. 502**

**CONSTRUCTION:**

\* **STAINLESS STEEL**



**ORDERING INFORMATION**

Minimum I.D. Inches	Maximum I.D. Inches	Projection Inches	Width Clamp Inches	Dealer Pkg. 10 Cards 1 Pair per Card	OEM Bulk Pkg. 50 Pcs.	Screw Size	Weight per Pair Ounces
5/8	1-1/4	1-1/2	1/2	502 DP1 STS	502 001 STS	6 R.H.	2
1	1-3/4	2-1/4	5/8	502 DP2 STS	502 002 STS	6 R.H.	2-1/2



## ROPE PULLEYS

**FIG. 1255 - COAMING ROPE PULLEY**

**CONSTRUCTION:**

- \* CHROME PLATED ZINC ALLOY
- \* WHITE PLASTIC SHEAVE
- \* MAXIMUM ROPE SIZE 1/4 INCH



**FIG. 1255**



**ORDERING INFORMATION**

O.D. Sheave Inches	Dimensions Plate Inches	Dealer Pkg. - 10 Cards 1 Pc. per Card	Screw Size	Weight Ounces
2-5/16	4-7/8 x 1-1/4	1255 DP CHR	6	1/2



**FIG. 565 - SWIVEL ROPE PULLEY**

**CONSTRUCTION:**

- \* STAINLESS STEEL WITH STRAP
- \* WHITE PLASTIC SHEAVE
- \* MAXIMUM ROPE SIZE 1/4 INCH



**FIG. 565**



**ORDERING INFORMATION**

O.D. Sheave Inches	Length Overall Inches	Length Strap Inches	Dealer Pkg. - 5 Cards 2 Pcs. per Card	Screw Size	Weight Ounces
2-5/16	3-3/4	1-5/8	565 DP	10 R.H.	2



**FIG. 634 - SWIVEL SNAP HOOK ROPE PULLEY**

**CONSTRUCTION:**

- \* STAINLESS STEEL
- \* WHITE PLASTIC SHEAVE
- \* MAXIMUM ROPE SIZE 1/4 INCH



**FIG. 634**



**ORDERING INFORMATION**

O.D. Sheave Inches	Length Overall Inches	Opening Snap Throat Inches	Dealer Pkg. - 5 Cards 2 Pcs. per Card	Weight Ounces
2-5/16	4-5/8	1/2	634 DP	2-1/2



## ROPE CLAMP, ROPE GUIDES & WINDSHIELD WIPER

**FIG. 1226 - ROPE CLAMP**



**FIG. 1226**

**CONSTRUCTION:**

- \* CHROME PLATED ZINC ALLOY
- \* FOR 1/8 OR 3/16 INCH ROPE



**ORDERING INFORMATION**

Length Overall Inches	Width Inches	Dealer Pkg. - 25 Cards 2 Pcs. per Card	OEM Bulk Pkg. 100 Pcs.	Weight Ounces
1-1/4	11/16	1226 DP CHR	1226 000 CHR	1



**FIG. 1256 & 1261 - ROPE GUIDES**



**FIG. 1261**

**CONSTRUCTION:**

- \* CHROME PLATED ZINC ALLOY



**ORDERING INFORMATION**

I.D. Hole Inches	Dimensions Base Inches	Dealer Pkg. 25 Cards 2 Pcs. per Card	OEM Bulk Pkg. 100 Pcs.	Screw Size	Weight Ounces
5/16	1-1/4 x 3/4	1256 DP CHR	1256 000 CHR	6	1/2
5/16	1-1/4 x 3/4	1261 DP CHR	1261 000 CHR	6	1/2

**FIG. 1256**



**FIG. 533 - HAND WINDSHIELD WIPER**

**CONSTRUCTION:**

- \* CHROME PLATED ZINC ALLOY
- \* 400 SERIES STAINLESS STEEL ARM AND BLADE HOLDER

For Straight and Curved Windshields,  
the Arm is Extendable from 6-3/4 to 10-1/2 Inches  
(Length Overall is 8 to 11-1/2 Inches), and the Spring Tension is Adjustable.



**ORDERING INFORMATION**

O.D. Shaft Inches	Max. Thickness of Panel Inches	Length Handle Inches	Length Blade Inches	Dealer Pkg. - 5 Pcs. 1 Pc. per Card	Weight Ounces
3/8	1-1/8	2-3/8	12	533 DP STS	8

Spare Arm, Cat. No. 533 000 99A.  
Spare Handle, Cat. No. 533 000 99D.

Spare Curved Blade, Cat. No. 533 000 99B.

**FIG. 533**



## ROPE GUIDE, SPRING & TIGHTENERS

**FIG. 1243 - ROPE GUIDE**

**CONSTRUCTION:**

- \* CHROME PLATED ZINC ALLOY
- \* BLACK PLASTIC SHEAVE



**ORDERING INFORMATION**

Maximum Rope Size Inches	O.D. Sheave Inches	Dimensions Base Inches	Dealer Pkg. - 10 Cards 1 Pc. per Card	Screw Size	Weight Ounces
1/4	7/8	2 x 3/4	1243 DP CHR	8	1-3/4



**FIG. 1243**



**FIG. 759 - DOCK LINE SPRING**

**CONSTRUCTION:**

- \* GALVANIZED SPRING STEEL



**FIG. 759**

**ORDERING INFORMATION**

For Rope Size Inches	Length Overall Inches	O.D. Inches	Compression Inches	Standard Package - 5 Pcs.	Weight Pounds
1/2	10	1-1/2	4-1/2	759 001 ZNC	7/8

**FIG. 732 - ROPE TIGHTENER**

**CONSTRUCTION OPTIONS:**

- \* ZINC ALLOY PLATED SPRING STEEL
- \* STAINLESS STEEL

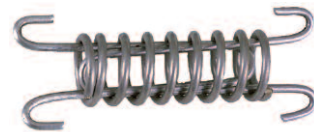
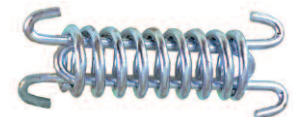

**FIG. 732 STAINLESS**



**ORDERING INFORMATION**

Finish	Length Normal Inches	Length Compressed Inches	O.D. Inches	Dealer Pkg. - 5 Cards 2 Pcs. per Card	Weight Ounces
Zinc Alloy	4	5	1	732 DP CAD	3-1/2
Stainless	4	5	1	732 DP STS	2-1/4



**FIG. 732 ZINC**



**FIG. 754 - ROPE TIGHTENER**

**CONSTRUCTION OPTIONS:**

- \* ZINC ALLOY PLATED SPRING STEEL



**ORDERING INFORMATION**

Length Normal Inches	Length Compressed Inches	O.D. Inches	Dealer Pkg. - 10 Cards 2 Pcs. per Card	Weight Ounces
4-3/4	6-1/2	7/8	754 DP CAD	2-3/4



**FIG. 754**



## FENDER LOCKS, HOOKS & EYE SNAP



Fig. 1299



FIG. 1299 - FENDER LOCK

**CONSTRUCTION:**

\* CHROME PLATED ZINC ALLOY

The Eye is to be Permanently Attached to the Fender Line.



**ORDERING INFORMATION**

I.D. Eye Inches	O.D. Flange Inches	Dealer Pkg. - 10 Cards 2 Pcs. per Card	OEM Bulk Pkg. 50 Pcs.	Screw Size	Weight Ounces
3/8	1-1/2	1299 DP CHR	1299 000 CHR	8	1

Spare Eye, Cat. No. 1299 000 99A.



Fig. 1246



FIG. 1246 - FENDER HOOK

**CONSTRUCTION:**

\* CHROME PLATED ZINC ALLOY



**ORDERING INFORMATION**

Maximum Rope Size Inches	Dimensions Plate Inches	Dealer Pkg. - 10 Cards 2 Pcs. per Card	Screw Size	Weight Ounces
3/8	1-3/4 x 1-1/4	1246 DP CHR	6	1-1/4



Fig. 1309



FIG. 1309 - SNAP TYPE FENDER HOOK

**CONSTRUCTION:**

\* CHROME PLATED ZINC ALLOY



**ORDERING INFORMATION**

Maximum Rope Size Inches	Dimensions Plate Inches	Dealer Pkg. 10 Cards 2 Pcs. per Card	OEM Bulk Pkg. 100 Pcs.	Screw Size	Weight Ounces
1/4	1-9/16 x 1-3/8	1309 DP CHR	1309 000 CHR	6	1-1/2



Fig. 1289



FIG. 1289 - SWIVEL EYE SNAP

**CONSTRUCTION:**

\* CHROME PLATED ZINC ALLOY

\* INTERLOCKING TONGUE



**ORDERING INFORMATION**

I.D. Eye Inches	Length Overall Inches	Dealer Pkg. - 10 Cards 1 Pc. per Card	Weight Ounces
5/8	3	1289 DP CHR	2-1/2

**NOTE: THIS SNAP SHOULD NOT BE USED FOR LIFTING, WINCHING, TOWING, MOORING OR LIKE APPLICATIONS.**



## EYE SNAPS

**NOTE: THE SNAPS ILLUSTRATED BELOW SHOULD NOT BE USED FOR LIFTING, WINCHING, TOWING, MOORING OR LIKE APPLICATIONS.**

### FIG. 612 - FAST EYE BOAT SNAP

**CONSTRUCTION:**

\* **PLAIN BRONZE**



**ORDERING INFORMATION**

I.D. Eye Inches	Length Overall Inches	Dealer Pkg. - 10 Cards 1 Pc. per Card	Weight Ounces
3/4	3	612 DP2 PLB	2
3/4	3-7/8	612 DP3 PLB	4



FIG. 612



### FIG. 614 - FAST EYE SNAP HOOK

**CONSTRUCTION:**

\* **NON-MAGNETIC 316 SERIES STAINLESS STEEL**

\* **INTERLOCKING TONGUE**



**ORDERING INFORMATION**

I.D. Eye Inches	Length Overall Inches	O.D. Stock Inches	Dealer Pkg. 10 Cards 1 Pc. per Card	Weight Ounces	Safe Working Load Pounds
3/8	3	5/16	614 DP STS	2-1/2	350



FIG. 614



### FIG. 1041 - SWIVEL BABY EYE SNAP

**CONSTRUCTION:**

\* **PLAIN BRONZE**



**ORDERING INFORMATION**

Dimensions Eye Inches	Length Overall Inches	Dealer Pkg. - 25 Cards 2 Pcs. per Card	Weight Ounces
5/8 x 5/16	2-1/8	1041 DP PLB	1/2



FIG. 1041



### FIG. 1042 - SWIVEL BABY EYE SNAP

**CONSTRUCTION:**

\* **PLAIN BRONZE**



**ORDERING INFORMATION**

I.D. Eye Inches	Length Overall Inches	Dealer Pkg. - 25 Cards 2 Pcs. per Card	Weight Ounces
3/8	2-1/8	1042 DP PLB	1/2



FIG. 1042



## ROWLOCK HORNS

**FIG. 1227 - NORTH RIVER TYPE ROWLOCK HORNS**



**FIG. 1227**

**CONSTRUCTION OPTIONS:**

- \* **PLAIN OR CHROME PLATED**
- ZINC ALLOY**



**ORDERING INFORMATION**

Finish	O.D. Shank Inches	Length Shank Inches	Between Horns Inches	Dealer Pkg. - 10 Cards 1 Pair per Card	Weight per Pair Ounces
Plain	1/2	1-3/4	1-3/4	1227 DP ZNC	10
Chrome	1/2	1-3/4	1-3/4	1227 DP CHR	10

**FIG. 1267 - ROUND TYPE ROWLOCK HORNS**



**FIG. 1267**

**CONSTRUCTION OPTIONS:**

- \* **PLAIN OR CHROME PLATED**
- ZINC ALLOY**



**ORDERING INFORMATION**

Finish	O.D. Shank Inches	Length Shank Inches	I.D. Horns Inches	Dealer Pkg. - 10 Cards 1 Pair per Card	Weight per Pair Ounces
Plain	1/2	1-3/4	2	1267 DP ZNC	9-1/2
Chrome	1/2	1-3/4	2	1267 DP CHR	9-1/2

**FIG. 1262 - RIBBED TYPE ROWLOCK HORNS**



**FIG. 1262**

**CONSTRUCTION OPTIONS:**

- \* **PLAIN OR CHROME PLATED**
- ZINC ALLOY**



**ORDERING INFORMATION**

Finish	O.D. Shank Inches	Length Shank Inches	Between Horns Inches	Dealer Pkg. - 10 Cards 1 Pair per Card	Weight per Pair Ounces
Plain	1/2	1-3/4	1-3/4	1262 DP ZNC	8
Chrome	1/2	1-3/4	1-3/4	1262 DP CHR	8

## ROWLOCK SOCKETS, OAR LEATHERS & BUTTONS

**FIG. 1185 - TOP MOUNT ROWLOCK SOCKETS**

**CONSTRUCTION OPTIONS:**

- \* **PLAIN OR CHROME PLATED ZINC ALLOY**
- \* **BLACK PLASTIC BEARINGS**



**ORDERING INFORMATION**

Finish	Length Inches	Width Inches	Depth Inches	Dealer Pkg.	OEM Bulk Pkg.	Weight per Pair Ounces
				10 Cards 1 Pair per Card	50 Pair	
Plain	2-7/8	1-1/8	1-1/8	1185 DP ZNC	1185 000 ZNC	5
Chrome	2-7/8	1-1/8	1-1/8	1185 DP CHR	1185 000 CHR	5



**Fig. 1185**

Screw Size #10.  
Spare Plastic Bearing, Cat. No. 1155 000 BLK.

**FIG. 1186 - EDGE MOUNT ROWLOCK SOCKETS**

**CONSTRUCTION OPTIONS:**

- \* **PLAIN OR CHROME PLATED ZINC ALLOY**
- \* **BLACK PLASTIC BEARINGS**



**ORDERING INFORMATION**

Finish	Length Inches	Width Inches	Depth Inches	Dealer Pkg. - 10 Cards	Weight per Pair Ounces
				1 Pair per Card	
Plain	4	7/8	1-1/8	1186 DP ZNC	9
Chrome	4	7/8	1-1/8	1186 DP CHR	9



**Fig. 1186**

Screw Size #10.  
Spare Plastic Bearing, Cat. No. 1155 000 BLK.

**FIG. 1187 - SIDE MOUNT ROWLOCK SOCKETS**

**CONSTRUCTION OPTIONS:**

- \* **PLAIN OR CHROME PLATED ZINC ALLOY**
- \* **BLACK PLASTIC BEARINGS**



**ORDERING INFORMATION**

Finish	Length Inches	Depth Inches	Dealer Pkg. - 10 Cards	Weight per Pair Ounces
			1 Pair per Card	
Plain	4	1-1/4	1187 DP ZNC	6
Chrome	4	1-1/4	1187 DP CHR	6



**Fig. 1187**

Screw Size #10.  
Spare Plastic Bearing, Cat. No. 1155 000 BLK.

**FIG. 233 - OAR LEATHERS & BUTTONS**

**CONSTRUCTION:**

- \* **LEATHER**



**ORDERING INFORMATION**

Dimensions Leather Inches	Dimensions Button Inches	Dealer Pkg. 5 Cards 1 Pair per Card	Weight per Pair Ounces
7 x 6-1/2	1/2 x 13	233 DP1	10



**Fig. 233**

Note: Pair Consists of 2 Leathers and 2 Buttons.



## ROWLOCK HORNS



**Fig. 828**

**FIG. 828 - RIBBED TYPE ROWLOCK HORNS**

**CONSTRUCTION:**

\* **PLAIN MANGANESE BRONZE**



**ORDERING INFORMATION**

O.D. Shank Inches*	Length Shank Inches	Between Horns Inches	Dealer Pkg. - 5 Cards 1 Pair per Card	Weight per Pair Ounces
1/2	2-1/8	2	828 DP PLB	13



**Fig. 829**

**FIG. 829 - ROUND TYPE ROWLOCK HORNS**

**CONSTRUCTION:**

\* **PLAIN MANGANESE BRONZE**



**ORDERING INFORMATION**

O.D. Shank Inches*	Length Shank Inches	I.D. Horn Inches	Dealer Pkg. - 5 Cards 1 Pair per Card	Weight per Pair Ounces
1/2	2-1/8	2	829 DP0 PLB	14
1/2	2-1/8	2-1/4	829 DP1 PLB	16



**Fig. 830**

**FIG. 830 - NORTH RIVER TYPE ROWLOCK HORNS**

**CONSTRUCTION:**

\* **PLAIN MANGANESE BRONZE**



**ORDERING INFORMATION**

O.D. Shank Inches*	Length Shank Inches	Between Horns Inches	Dealer Pkg. - 5 Cards 1 Pair per Card	Weight per Pair Ounces
1/2	2-1/8	2-1/8	830 DP PLB	13

**FIGS. 831, 832 & 833 - ROWLOCK SOCKETS**

**CONSTRUCTION:**

\* **PLAIN MANGANESE BRONZE**



**ORDERING INFORMATION**



**Fig. 831**



**Fig. 832**



**Fig. 833**

Mount	Length Inches	Width Inches	Depth Inches	Dealer Pkg. 5 Cards 1 Pair per Card	Weight per Pair Ounces
Top	2-3/8	7/8	1	831 DP PLB	4
Side	3-5/8	---	1-3/8	832 DP PLB	7
Edge	4	3/4	1-3/4	833 DP PLB	8

Screw Size #10.

**\*Note:** The Plain Bronze Oarlocks listed on this page were designed for use only with the matching plain bronze rowlock sockets Figs 831-833.

## WINDSHIELD ADJUSTERS

**FIG. 359 - WINDSHIELD ADJUSTERS**

**CONSTRUCTION:**

- \* **BLACK ANODIZED ALUMINUM SLIDE**
- \* **BLACK PLASTIC TRACK**
- \* **CHROME PLATED BRASS ARM**
- \* **BLACK PLASTIC KNOB AND END FITTINGS**

**ORDERING INFORMATION**

Length Overall Inches	Length Adjustment Inches	Standard Pkg. - 1 Each	Screw Size	Weight Pounds
9	4-3/4	359 001 BLK	8	1/2
14	9-3/8	359 002 BLK	8	3/4
19	14-5/8	359 003 BLK	8	1



**FIG. 359**

**FIG. 1290 & 1291 - WINDSHIELD ADJUSTERS**

**CONSTRUCTION:**

- \* **CHROME PLATED ZINC ALLOY**
- \* **BLACK PLASTIC KNOB**

**FIG. 1290 - SIDE MOUNT**

**FIG. 1291 - OFFSET MOUNT**



**ORDERING INFORMATION**

Length Overall Inches	Length Adjustment Inches	Dealer Pkg. 5 Cards 1 Pair per Card	OEM Bulk Pkg. 10 Pair	Screw Size	Weight per Pair Pounds
12	9-1/2	1290 DP CHR	1290 000 CHR	8	1-1/2
12	9-1/2	1291 DP CHR	1291 000 CHR	8	1-1/2

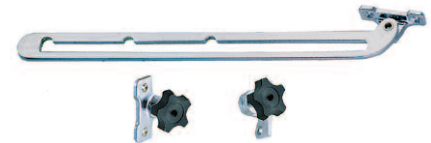

**FIG. 1290 SIDE MOUNT**

**FIG. 1291 OFFSET MOUNT**

**SPARE PARTS ORDERING INFORMATION**

Figure No.	Port Adjuster	Starboard Adjuster	Mounting Bracket With Knob	Knob Only
1290	1290 P00 99A	1290 S00 99A	1290 000 99B	1292 000 BLK
1291	1291 P00 99A	1291 S00 99A	1291 000 99B	1292 000 BLK

NOTE: Illustration is Port Side.

**FIG. 82 - WINDSHIELD ADJUSTER**

**CONSTRUCTION:**

- \* **CHROME PLATED BRASS AND BRONZE**
- \* **BLACK PLASTIC KNOB**

**ORDERING INFORMATION**

Length Overall Inches	Length Adjustment Inches	Standard Pkg. - 1 Pair	Screw Size	Weight per Pair Pounds
12	9-1/2	82 000 CHR	8	2-3/8

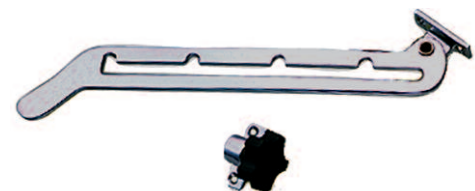

**FIG. 82**

Spare Port Adjuster, Cat. No. 82 P00 99B.  
 Spare Starboard Adjuster, Cat. No. 82 S00 99B.  
 Spare Knob, Cat. No. 82 000 99A.

NOTE: Illustration is Port Side.

## WINDSHIELD ADJUSTERS

**FIG. 1179 - WINDSHIELD ADJUSTER**



**FIG. 1179**

**CONSTRUCTION:**

- \* CHROME PLATED BRASS AND ZINC ALLOY
- \* BLACK PLASTIC KNOB



**ORDERING INFORMATION**

Length Closed Inches	Length Open Inches	O.D. Tube Inches	Dealer Pkg. 5 Cards 1 Pc. per Card	OEM Bulk Pkg. 20 Pcs.	Screw Size	Weight Ounces
10	18	1/2	1179 DP1 CHR	1179 001 CHR	6	9
12	20	1/2	1179 DP2 CHR	1179 002 CHR	6	11

Spare Knob, Cat. No. 1117 DP BLK.

**FIG. 1180 - WINDSHIELD ADJUSTER**



**FIG. 1180**

**CONSTRUCTION:**

- \* CHROME PLATED BRASS AND ZINC ALLOY
- \* BLACK PLASTIC KNOB



**ORDERING INFORMATION**

Length Closed Inches	Length Open Inches	O.D. Tube Inches	Dealer Pkg. 5 Cards 1 Pc. per Card	OEM Bulk Pkg. 20 Pcs.	Screw Size	Weight Ounces
12	21	1/2	1180 DP CHR	1180 000 CHR	6	10

Spare Knob, Cat. No. 1117 DP BLK.

**FIG. 1116 - WINDSHIELD ADJUSTER**



**FIG. 1116**

**CONSTRUCTION:**

- \* CHROME PLATED BRASS AND ZINC ALLOY
- \* BLACK PLASTIC KNOB



**ORDERING INFORMATION**

Length Rod Inches	O.D. Rod Inches	Dealer Pkg. 5 Cards 1 Pc. per Card	OEM Bulk Pkg. 20 Pcs.	Screw Size	Weight Ounces
8	3/8	1116 DP1 CHR	1116 001 CHR	8	8
10	3/8	1116 DP2 CHR	1116 002 CHR	8	10
12	3/8	1116 DP3 CHR	1116 003 CHR	8	12

Spare Knob, Cat. No. 1117 DP BLK.

## HATCH ADJUSTER, BRACES & FASTENER

**FIG. 797 - HATCH ADJUSTER**

**CONSTRUCTION:**

- \* CHROME PLATED BRASS AND ZINC ALLOY
- \* BLACK PLASTIC KNOB



**FIG. 797**



**ORDERING INFORMATION**

Length Arm Inches	Length Adjustment Inches	Length Slide Inches	Dealer Pkg. 5 Cards 1 Pc. per Card	Screw Size	Weight Ounces
10	9-1/2	10-3/4	797 DP CHR	8	13

**FIG. 762 - HATCH SUPPORT BRACES**

**CONSTRUCTION:**

- \* CHROME PLATED BRASS



**ORDERING INFORMATION**

Length Open Inches	Dealer Pkg. - 5 Cards 1 Pair per Card	OEM Bulk Pkg. 20 Pair	Screw Size	Weight per Pair Ounces
10	762 DP1 CHR	762 001 CHR	8	10
12	762 DP2 CHR	762 002 CHR	8	12
14	762 DP3 CHR	762 003 CHR	8	14

NOTE: Illustration is Port Side.



**FIG. 762**

**FIG. 155 - HATCH FASTENER OR WINDSHIELD KEEPER**

**CONSTRUCTION:**

- \* CHROME PLATED BRASS AND ZINC ALLOY
- \* PHOSPHOR BRONZE SPRING



**ORDERING INFORMATION**

Length Overall Inches	Dimensions		Dealer Pkg. 5 Cards 1 Pc. per Card	OEM Bulk Pkg. 50 Pcs.	Screw Size	Weight Ounces
	Mounting Base Inches					
3-7/8	1-1/2 x 9/16		155 DP CHR	155 000 CHR	6	3-1/4



**FIG. 155**

## HATCH FASTENERS OR WINDSHIELD KEEPERS

**FIG. 769 - HATCH FASTENER OR WINDSHIELD KEEPER**



**FIG. 769**

**CONSTRUCTION:**

- \* CHROME PLATED BRASS AND ZINC ALLOY.
- \* BLACK PLASTIC KNOB.



**ORDERING INFORMATION**

Dimensions	Dealer Pkg.	OEM	Screw Size	Weight Ounces
Base Inches	5 Cards 1 Pc. per Card	Bulk Pkg. 25 Pcs.		
1-1/2 x 5/8	769 DP CHR	769 000 CHR	8	6

Spare Keeper, Cat. No. 769 000 99A.  
Spare Handle with Stud, Cat. No. 769 000 99C.

**FIG. 697 - HATCH FASTENER OR WINDSHIELD KEEPER**

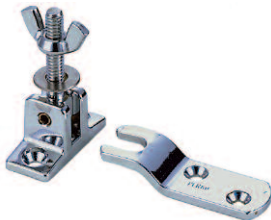

**FIG. 697**

**CONSTRUCTION:**

- \* CHROME PLATED BRASS AND ZINC ALLOY.



**ORDERING INFORMATION**

Length Bolt Inches	Dimensions Bracket Inches	Dimensions Keeper Inches	Dealer Pkg.	Screw Size	Weight Ounces
1-1/2	1-1/2 x 5/8	1-1/2 x 3/4	10 Cards 1 Pc. per Card	8	3

**FIG. 967 - HATCH FASTENER OR WINDSHIELD KEEPER**



**FIG. 967**

**CONSTRUCTION:**

- \* CHROME PLATED BRONZE.



**ORDERING INFORMATION**

Length Bolt Inches	Dimensions Bracket Inches	Dimensions Keeper Inches	Dealer Pkg.	Screw Size	Weight Ounces
1-1/2	1-9/16 x 1	1-7/8 x 7/8	5 Cards 1 Pc. per Card	8	6

**FIG. 770 - HATCH FASTENER**

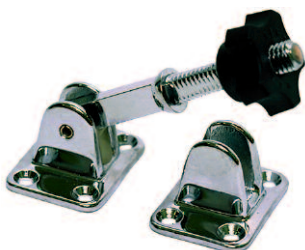

**FIG. 770**

**CONSTRUCTION:**

- \* CHROME PLATED BRONZE.
- \* BLACK PLASTIC KNOB.



**ORDERING INFORMATION**

Dimensions Overall Inches	Adjustment Thread Inches	Dealer Pkg.	OEM	Screw Size	Weight Ounces
3-1/2 x 1-5/8	7/8	5 Cards 1 Pc. per Card	Bulk Pkg. 25 Pcs.	8	6
		770 DP CHR	770 000 CHR		



## HOLD-DOWN CLAMPS

**FIG. 1112 - HOLD-DOWN CLAMP**

**CONSTRUCTION:**

- \* **CHROME PLATED BRONZE**
- \* **FLAT MOUNTING**



**FIG. 1112**



**ORDERING INFORMATION**

Length Inches	Width Inches	Dealer Pkg. - 5 Cards 1 Pc. per Card	OEM Bulk Pkg. 25 Pcs.	Screw Size	Weight Ounces
3	1-1/2	1112 DP CHR	1112 000 CHR	8	5-1/2

**FIG. 1113 - HOLD-DOWN CLAMP**

**CONSTRUCTION:**

- \* **CHROME PLATED BRONZE**
- \* **RIGHT ANGLE MOUNTING**



**FIG. 1113**



**ORDERING INFORMATION**

Length Inches	Width Inches	Dealer Pkg. - 5 Cards 1 Pc. per Card	OEM Bulk Pkg. 25 Pcs.	Screw Size	Weight Ounces
2-1/2	1-1/2	1113 DP CHR	1113 000 CHR	8	5-1/2

**FIG. 1108 - LOCKABLE HOLD-DOWN CLAMP**

**CONSTRUCTION:**

- \* **CHROME PLATED BRONZE**

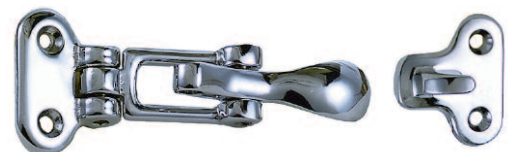

**FIG. 1108**



**ORDERING INFORMATION**

Dimensions Base Inches	Clearance Padlock Inches	Dealer Pkg. 5 Cards 1 Pc. per Card	OEM Bulk Pkg. 25 Pcs.	Screw Size	Weight Ounces
2-3/4 x 1-3/4	1/4	1108 DP CHR	1108 000 CHR	6	4

## PULL APART HINGES, HATCH TRIM & CONTINUOUS HINGE



**FIG. 149**  
**LEFT HAND**

**FIGS. 149 & 152 - PULL APART HINGES**

**CONSTRUCTION:**

\* **CHROME PLATED BRONZE**

**FIG. 149 - LEFT HAND**

**FIG. 152 - RIGHT HAND**



**FIG. 152**  
**RIGHT HAND**

Use 2 Left Hand or 2 Right Hand For Quick Removal of Hatches, Motor Covers, etc. or Together (1 each Left & Right) as a Heavy Duty Hinge Set.



**ORDERING INFORMATION**

Length Open Inches	Width Overall Inches	Dealer Pkg. 5 Cards 1 Pc. per Card	OEM Pkg. - 25 Pcs.	Screw Size	Weight Ounces
3-3/4	2	149 DP CHR	149 000 CHR	10	5-1/2
3-3/4	2	152 DP CHR	152 000 CHR	10	5-1/2

**FIG. 258 - HATCH TRIM**



**FIG. 258**

**CONSTRUCTION:**

\* **POLISHED STAINLESS STEEL**

**ORDERING INFORMATION**

Width Inches	Length Overall Inches	Standard Pkg. - 10 Pcs.	Screw Size	Weight Pounds
1-1/4	72	258 002 STS	6	1
1-1/2	72	258 004 STS	6	1-1/2



**FIG. 212 - CONTINUOUS HINGE**



**FIG. 212**

**CONSTRUCTION:**

- \* **POLISHED STAINLESS STEEL**
- \* **COUNTERSUNK HOLES ARE TWO INCHES APART, CENTER TO CENTER**

**ORDERING INFORMATION**

Width Open Inches	Length Overall Inches	Standard Pkg. - 10 Pcs.	Screw Size	Weight Pounds
1-1/4	72	212 002 STS	6	1-1/2
1-1/2	72	212 004 STS	6	2



## BUTT HINGES

**FIG. 1002 - BUTT HINGE**

- CONSTRUCTION:**
- \* **HEAVY GAUGE EXTRUDED BRASS**
  - \* **CHROME PLATED**
  - \* **FAST PIN**

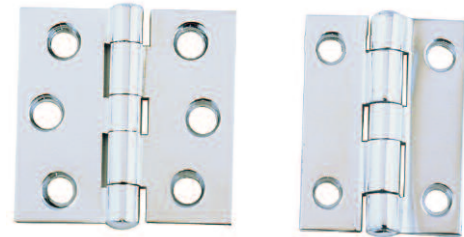

**FIG. 1002**



### ORDERING INFORMATION

Height Pin Inches	Width Open Inches	Dealer Pkg. 1 Pair per Card	Cards per Pkg.	Standard Pkg. Catalog No.	Std. Pkg. Pair	Screw Size	No. of Holes	Weight per Pair Pounds
2	1-1/2	1002 003 DP	5	1002 003 CHR	5	6	4	1/4
2	2	1002 004 DP	5	1002 004 CHR	5	6	6	3/8
3	2	1002 007 DP	5	1002 007 CHR	5	8	6	5/8
3	3	1002 009 DP	1	1002 009 CHR	5	10	6	1-1/4
3-1/2	2-1/2	-----	---	1002 010 CHR	1	10	6	7/8
3-1/2	3	-----	---	1002 011 CHR	1	10	6	1-1/4
4	3	1002 012 DP	1	1002 012 CHR	1	10	6	1-1/2
4	4	1002 013 DP	1	1002 013 CHR	1	1/4	6	1-7/8
5	4	-----	---	1002 014 CHR	1	1/4	8	2-1/4

**FIG. 1004 - BUTT HINGE**

- CONSTRUCTION:**
- \* **CHROME PLATED EXTRUDED BRASS**
  - \* **EXTRA HEAVY DUTY, PLASTIC BEARINGS**
  - \* **REMOVABLE PIN**

For Transom Doors and Other Applications  
Where Extra Strength is Required.



**FIG. 1004**



### ORDERING INFORMATION

Height Pin Inches	Width Open Inches	Dealer Pkg. - 1 Card 1 Pair per Card	Screw Size	No. of Holes	Weight per Pair Pounds
4	4	1004 DP CHR	1/4	6	1-7/8

## BUTT HINGES

**FIG. 1293 - BUTT HINGE**



**FIG. 1293**

- CONSTRUCTION:**
- \* CHROME PLATED ZINC ALLOY
  - \* REMOVABLE PIN



**ORDERING INFORMATION**

Height Pin Inches	Width Open Inches	Dealer Pkg. 5 Cards 1 Pair per Card	OEM Bulk Pkg. 25 Pair	Screw Size	No. of Holes	Weight per Pair Ounces
1-1/2	1-1/2	1293 DP2 CHR	-----	8	4	2
2	1-1/2	1293 DP3 CHR	-----	8	4	2-1/2
2	2	1293 DP4 CHR	*1293 004 CHR	8	4	3
2-1/2	2	1293 DP5 CHR	1293 005 CHR	8	6	4-1/2
2-1/2	2-1/2	1293 DP6 CHR	1293 006 CHR	8	6	5
3	3	1293 DP9 CHR	1293 009 CHR	10	6	7-1/2

\* OEM Bulk Pkg. - 50 Pair.

**FIG. 949 - BUTT HINGE**



**FIG. 949**

- CONSTRUCTION:**
- \* HEAVY GAUGE STAMPED BRASS
  - \* CHROME PLATED
  - \* FAST PIN



**ORDERING INFORMATION**

Height Pin Inches	Width Open Inches	Chrome Plated Brass Dealer Pkg. - 5 Cards 1 Pair per Card	Chrome Plated Brass OEM Bulk Pkg. 25 Pair	Screw Size	No. of Holes	Weight per Pair Ounces
1-1/2	1-1/4	949 DP1 CHR	-----	6	4	2
1-1/2	1-1/2	949 DP2 CHR	-----	6	4	2-1/2
2	1-1/2	949 DP3 CHR	-----	6	4	2-3/4
2	2	949 DP4 CHR	949 004 CHR	6	6	4
2-1/2	2	949 DP5 CHR	949 005 CHR	8	6	5
2-1/2	2-1/2	949 DP6 CHR	949 006 CHR	8	6	6-3/4
3	3	949 DP9 CHR	949 009 CHR	10	6	9-1/2

**FIG. 941 - BUTT HINGE**



**FIG. 941**

- CONSTRUCTION:**
- \* CHROME PLATED ZINC ALLOY



**ORDERING INFORMATION**

Height Pin Inches	Width Open Inches	Dealer Pkg. 5 Cards 1 Pair per Card	OEM Bulk Pkg. 50 Pair	Screw Size	Weight per Pair Ounces
1-1/2	1-1/2	941 DP CHR	941 000 CHR	8	2-1/2

## BUTT HINGES

**FIG. 952 - BUTT HINGE**

**CONSTRUCTION:**

- \* **HEAVY GAUGE STAMPED BRASS**
- \* **CHROME PLATED**
- \* **REMOVABLE PIN**



**ORDERING INFORMATION**

Height Pin Inches	Width Open Inches	Chrome Plated Brass Dealer Pkg. - 5 Cards 1 Pair per Card	Chrome Plated Brass OEM Bulk Pkg. 25 Pair	Screw Size	No. of Holes	Weight per Pair Ounces
1-1/2	1-1/4	952 DP1 CHR	-----	6	4	2
1-1/2	1-1/2	952 DP2 CHR	-----	6	4	2-1/2
2	1-1/2	952 DP3 CHR	-----	6	4	2-3/4
2	2	952 DP4 CHR	952 004 CHR	6	6	4
2-1/2	2	952 DP5 CHR	952 005 CHR	8	6	5
2-1/2	2-1/2	952 DP6 CHR	-----	8	6	6-3/4
3	3	952 DP9 CHR	952 009 CHR	10	6	9-1/2



**FIG. 952**

**FIG. 773 - HINGE**

**CONSTRUCTION:**

- \* **CHROME PLATED BRONZE**
- \* **REMOVABLE PIN**



**ORDERING INFORMATION**

Length Overall Inches	Width Overall Inches	Dealer Pkg. - 2 Cards 1 Pair per Card	Screw Size	Weight per Pair Pounds
3-1/8	2-5/8	773 DP CHR	10	1-5/8



**FIG. 773**

**FIG. 951 - HINGE**

**CONSTRUCTION:**

- \* **CHROME PLATED BRONZE**



**ORDERING INFORMATION**

Width Open Inches	Height Pin Inches	Dealer Pkg. 5 Cards 1 Pair per Card	OEM Bulk Pkg. 25 Pair	Screw Size	Weight per Pair Ounces
3	1-1/2	951 DP1 CHR	951 001 CHR	8	3-1/2
4	1-1/2	951 DP2 CHR	951 002 CHR	8	5-1/2



**FIG. 951**

## HINGES

**FIG. 808 - HINGE**



**FIG. 808**

**CONSTRUCTION:**  
\* **CHROME PLATED ZINC ALLOY**



**ORDERING INFORMATION**

Width Open Inches	Height Pin Inches	Dealer Pkg. 10 Cards 1 Pair per Card	OEM Bulk Pkg. 50 Pair	Screw Size	Weight per Pair Ounces
3	1-1/2	808 DP CHR	808 000 CHR	8	3-1/2

**FIGS. 987 & 1213 - SHORTSIDE HINGES**



**FIG. 987**  
**CHROME PLATED BRONZE**  
**FIG. 1213**  
**CHROME PLATED ZINC ALLOY**

**CONSTRUCTION OPTIONS:**  
**FIG. 987 - CHROME PLATED BRONZE**  
**FIG. 1213 - CHROME PLATED ZINC ALLOY**



**ORDERING INFORMATION**

Width Open Inches	Height Pin Inches	Width Shortside Inches	Dealer Pkg. 5 Cards 1 Pair per Card	OEM Bulk Pkg. 50 Pair	Screw Size	Weight per Pair Ounces
2-1/4	1-1/2	3/4	987 DP1 CHR	987 001 CHR	8	3-1/2
2-3/4	1-1/2	3/4	987 DP2 CHR	-----	8	4
2-1/2	1-1/2	3/4	1213 DP1 CHR	1213 001 CHR	8	3

**FIGS. 988 & 1214 - OFFSET SHORTSIDE HINGES**



**FIG. 988**  
**CHROME PLATED BRONZE**  
**FIG. 1214**  
**CHROME PLATED ZINC ALLOY**

**CONSTRUCTION OPTIONS:**  
**FIG. 988 - CHROME PLATED BRONZE**  
**FIG. 1214 - CHROME PLATED ZINC ALLOY**



**ORDERING INFORMATION**

Width Open Inches	Height Pin Inches	Width Shortside Inches	Offset Inches	Dealer Pkg. 5 Cards 1 Pair per Card	Screw Size	Weight per Pair Ounces
2-1/4	1-1/2	3/4	3/8	988 DP1 CHR	8	4
2-3/4	1-1/2	3/4	3/8	988 DP2 CHR	8	5
2-1/2	1-1/2	3/4	3/8	1214 DP1 CHR	8	4

**FIG. 999 - SHORTSIDE HINGE**



**FIG. 999**

**CONSTRUCTION:**  
\* **CHROME PLATED BRONZE**



**ORDERING INFORMATION**

Width Open Inches	Height Pin Inches	Width Shortside Inches	Dealer Pkg. - 5 Cards 1 Pair per Card	Screw Size	Weight per Pair Ounces
3-1/2	1-1/2	1-1/2	999 DP CHR	8	5

## HINGES

**FIG. 942 - OFFSET HINGE**

- CONSTRUCTION:**  
 \* CHROME PLATED ZINC ALLOY



**ORDERING INFORMATION**

Width Open Inches	Height Pin Inches	Offset Inches	Dealer Pkg. 5 Cards 1 Pair per Card	OEM Bulk Pkg. 50 Pair	Screw Size	Weight per Pair Ounces
1-1/2	1-1/2	3/8	942 DP CHR	942 000 CHR	8	2-1/2



**FIG. 942**

**FIG. 271 - INSET HINGE**

- CONSTRUCTION:**  
 \* SEMI-CONCEALED  
 \* FOR INSET DOORS  
 \* CHROME PLATED STAMPED BRASS  
 \* 3/8 INCH INSET



**ORDERING INFORMATION**

Dimensions Inches	Dealer Pkg. 10 Cards 1 Pair per Card	OEM Bulk Pkg. 100 Pair	Screw Size	Weight per Pair Ounces
2-3/4 x 2-1/8	271 DP CHR	271 000 CHR	4	2-1/2



**FIG. 271**

**FIG. 272 - FLUSH HINGE**

- CONSTRUCTION:**  
 \* SEMI-CONCEALED  
 \* FOR OVERLAY DOORS  
 \* CHROME PLATED STAMPED BRASS



**ORDERING INFORMATION**

Dimensions Inches	Dealer Pkg. 10 Cards 1 Pair per Card	OEM Bulk Pkg. 100 Pair	Screw Size	Weight per Pair Ounces
2-3/4 x 2-1/8	272 DP CHR	272 000 CHR	4	2-1/2



**FIG. 272**

## HINGES

**FIG. 120 - STRAP HINGE**



**FIG. 120**

**CONSTRUCTION:**

\* **CHROME PLATED BRONZE**



**ORDERING INFORMATION**

Width Open Inches	Height Pin Inches	Dealer Pkg. 5 Cards 1 Pair per Card	Screw Size	No. of Holes	Weight per Pair Ounces
4	1-1/8	120 DP1 CHR	10	4	6
6	1-1/8	120 DP2 CHR	10	6	8
8	1-3/8	120 DP3 CHR	12	6	16

**FIG. 122 - SHORTSIDE STRAP HINGE**



**FIG. 122**

**CONSTRUCTION:**

\* **CHROME PLATED BRONZE**



**ORDERING INFORMATION**

Width Open Inches	Height Pin Inches	Length Shortside Inches	Dealer Pkg. 5 Cards 1 Pair per Card	Screw Size	No. of Holes	Weight per Pair Ounces
4-7/8	1-1/8	2-1/16	122 DP CHR	10	5	7

**FIG. 197 - "T" HINGE**



**FIG. 197**

**CONSTRUCTION:**

\* **CHROME PLATED BRONZE**



**ORDERING INFORMATION**

Width Open Inches	Height Overall Inches	Width "T" Side Inches	Dealer Pkg. 5 Cards 1 Pair per Card	Screw Size	No. of Holes	Weight per Pair Ounces
4	2-1/8	1-5/16	197 DP1 CHR	10	6	8
6	3	1-1/2	197 DP2 CHR	10	7	16
8	3-7/8	2	197 DP3 CHR*	12	8	25

\* Dealer Pkg. - 2 Cards, 1 Pair per Card.

**FIG. 924 - HINGE**



**FIG. 924**

**CONSTRUCTION:**

\* **CHROME PLATED STAMPED BRASS**



**ORDERING INFORMATION**

Width Open Inches	Height Pin Inches	Dealer Pkg. - 10 Cards 1 Pair per Card	Screw Size	Weight per Pair Ounces
3	1-1/2	924 DP CHR	6	2-1/2



## HINGE & HASPS

**FIG. 957 - NON-MORTISED HINGE**

**CONSTRUCTION:**

- \* CHROME PLATED STAMPED BRASS
- \* EASILY INSTALLS WITHOUT MORTISING



**ORDERING INFORMATION**

Height Pin Inches	Width Closed Inches	Dealer Pkg. 5 Cards 1 Pair per Card	OEM Bulk Pkg. 50 Pair	Screw Size	Weight per Pair Ounces
3-3/8	7/8	957 DP CHR	957 000 CHR	8	4



**FIG. 957**

**FIG. 998 - HASP**

**CONSTRUCTION:**

- \* CHROME PLATED BRONZE



**ORDERING INFORMATION**

Length Closed Inches	Width Overall Inches	Padlock Clearance Inches	Dealer Pkg. 10 Cards 1 Pc. per Card	OEM Bulk Pkg. 25 Pcs.	Screw Size	Weight Ounces
2	1	9/32	998 DP1 CHR	998 001 CHR	6	2
3	1	9/32	998 DP2 CHR	998 002 CHR	6	3

Spare Chrome Keepers (2 per card), Cat. No. 959 DP CHR.



**FIG. 998**

**FIG. 1198 - HASP**

**CONSTRUCTION:**

- \* CHROME PLATED ZINC ALLOY



**ORDERING INFORMATION**

Length Closed Inches	Width Inches	Padlock Clearance Inches	Dealer Pkg. 10 Cards 1 Pc. per Card	OEM Bulk Pkg. 25 Pcs.	Screw Size	Weight Ounces
2	1	1/4	1198 DP1 CHR	1198 001 CHR	6	1-1/2
3	1	1/4	1198 DP2 CHR	1198 002 CHR	6	2-1/4
3-3/4	1	1/4	1198 DP3 CHR	1198 003 CHR	6	2-1/2

Spare Keepers (2 per card), Cat. No. 1261 DP CHR.



**FIG. 1198**

**FIG. 1194 - SWIVEL EYE HASP**

**CONSTRUCTION:**

- \* CHROME PLATED ZINC ALLOY
- \* PADLOCK EYE SWIVELS TO ACT AS A LATCH



**ORDERING INFORMATION**

Length Closed Inches	Width Inches	Padlock Clearance Inches	Dealer Pkg. 10 Cards 1 Pc. per Card	OEM Bulk Pkg. 50 Pcs.	Screw Size	Weight Ounces
3	1	11/32	1194 DP CHR	1194 000 CHR	6	2-1/2

Spare Keepers (1 per card), Cat. No. 1194 DP 99A.



**FIG. 1194**

## BARREL BOLTS & SHIP BOLT

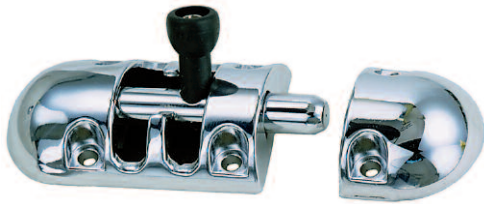

**FIG. 1244**

**FIG. 1244 - BARREL BOLT**

**CONSTRUCTION:**

**\* CHROME PLATED ZINC ALLOY**

**INTEGRAL FRICTION PAD ELIMINATES RATTLE AND PROVIDES SMOOTH OPERATION.**



**ORDERING INFORMATION**

Dimensions	Dealer Pkg. - 5 Cards	OEM Bulk Pkg.	Screw Size	Weight Ounces
Overall Inches	1 Pc. per Card	25 Pcs.		
3-3/8 x 1-1/4	1244 DP CHR	1244 000 CHR	6 R.H.	3



**FIG. 947**

**FIG. 947 - BARREL BOLT**

**CONSTRUCTION:**

**\* CHROME PLATED BRONZE**

**SUPPLIED WITH FRICTION PAD TO ELIMINATE RATTLE AND PROVIDE SMOOTH OPERATION.**



**ORDERING INFORMATION**

Dimensions	Chrome Plated Bronze	Chrome Plated Bronze	Screw Size	Weight Ounces
Overall Inches	Dealer Pkg. - 5 Cards	OEM Bulk Pkg.		
	1 Pc. per Card	25 Pcs.		
3-7/16 x 1-7/16	947 DP1 CHR	947 001 CHR	6	4
4-5/16 x 1-7/16	947 DP2 CHR	947 002 CHR	6	4-1/2
5-1/4 x 1-7/16	947 DP3 CHR	947 003 CHR	6	5

**FIG. 1053 - SHIP BOLT**

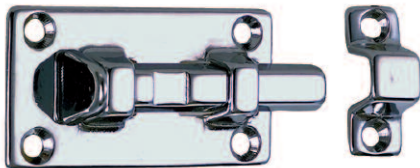

**FIG. 1053**

**CONSTRUCTION:**

**\* CHROME PLATED BRONZE**

**SUPPLIED WITH BRASS FRICTION SPRING TO ELIMINATE RATTLE AND PROVIDE DETENTED OPERATION.**



**ORDERING INFORMATION**

Dimensions	Dealer Pkg. - 5 Cards	OEM Bulk Pkg.	Screw Size	Weight Ounces
Overall Inches	1 Pc. per Card	25 Pcs.		
2-5/8 x 1-1/4	1053 DP CHR	1053 000 CHR	6	1-3/4

## CABIN DOOR HOOKS

**FIG. 956 - CABIN DOOR HOOK**

**CONSTRUCTION:**

**\* CAST BRONZE**

**PLAIN OR CHROME PLATED**



**ORDERING INFORMATION**

Length Hook Inches	Chrome Plated Bronze Dealer Pkg. - 5 Cards 1 Pc. per Card	Chrome Plated Bronze OEM Bulk Pkg. 50 Pcs.	Plain Bronze Standard Pkg. - 5 Pcs.	Weight Ounces
1-1/2	956 DP1 CHR	956 001 CHR	956 001 PLB	1
2	956 DP2 CHR	956 002 CHR	956 002 PLB	1-1/2
2-1/2	956 DP3 CHR	956 003 CHR	956 003 PLB	1-3/4
3	956 DP4 CHR	956 004 CHR	956 004 PLB	2
3-1/2	956 DP5 CHR	-----	956 005 PLB	2-1/2
4	956 DP6 CHR	-----	956 006 PLB	3
5	956 DP7 CHR	-----	956 007 PLB	3-1/2
6	956 DP8 CHR	*956 008 CHR	956 008 PLB	5

\*O.E.M. Bulk Pkg. - 25 pcs.

Screw Size #6.

Spare Plain Keepers, (2 per card), Cat. No. 959 DP PLB.

Spare Chrome Keepers, (2 per card), Cat. No. 959 DP CHR

Spare Chrome Keepers, O.E.M Bulk (100 pcs.) Cat. No. 959 000 CHR



**FIG. 956**



**FIG. 959  
SPARE KEEPER**

**FIG. 1199 - CABIN DOOR HOOK**

**CONSTRUCTION:**

**\* CHROME PLATED ZINC ALLOY**



**ORDERING INFORMATION**

Length Hook Inches	Dealer Pkg. 20 Cards 1 Pc. per Card	OEM Bulk Pkg. 50 Pcs.	Screw Size	Weight Ounces
1-3/4	1199 DP1 CHR	1199 001 CHR	6	1-1/4
2-1/4	1199 DP2 CHR	1199 002 CHR	6	1-3/8
3	1199 DP3 CHR	1199 003 CHR	6	1-1/2
4	1199 DP4 CHR	1199 004 CHR	6	1-3/4

Spare Keepers, (2 per card), Cat. No. 1261 DP CHR.



**FIG. 1199**



**FIG. 1261  
SPARE KEEPER**

**FIG. 1287 - CABIN DOOR HOOK**

**CONSTRUCTION:**

**\* CHROME PLATED ZINC ALLOY**



**ORDERING INFORMATION**

Length Hook Inches	Dealer Pkg. 20 Cards 1 Pc. per Card	OEM Bulk Pkg. 50 Pcs.	Screw Size	Weight Ounces
2	1287 DP1 CHR	1287 001 CHR	6	1-1/4
2-1/2	1287 DP2 CHR	1287 002 CHR	6	1-1/2
3	1287 DP3 CHR	1287 003 CHR	6	1-3/4

Spare Keepers, (2 per card), Cat. No. 1261 DP CHR.



**FIG. 1287**



**FIG. 1261  
SPARE KEEPER**

## DOOR STOPS & HOLDERS

**FIG. 574 - DOOR STOP AND HOLDER**



**FIG. 574**

- CONSTRUCTION:**  
 \* CHROME PLATED BRONZE  
 \* RUBBER BUMPER



**ORDERING INFORMATION**

Length Inches	O.D. Inches	Dealer Pkg. 5 Cards 1 Pc. per Card	OEM Bulk Pkg. 25 Pcs.	Stop Screw Size	Keeper Screw Size	Weight Ounces
2-3/8	1-3/4	574 DP1 CHR	574 001 CHR	8	6	4-1/2
3-1/4	1-3/4	574 DP2 CHR	574 002 CHR	8	6	5-1/2

**FIG. 1177 - DOOR STOP**



**FIG. 1177**

- CONSTRUCTION:**  
 \* CHROME PLATED ZINC ALLOY  
 \* RUBBER BUMPER



**ORDERING INFORMATION**

Length Inches	O.D. Inches	Dealer Pkg. - 5 Cards 1 Pc. per Card	OEM Bulk Pkg. 50 Pcs.	Screw Size	Weight Ounces
1	1-1/4	1177 DP CHR	1177 000 CHR	4	1

**FIG. 1065 - DOOR HOLDER**

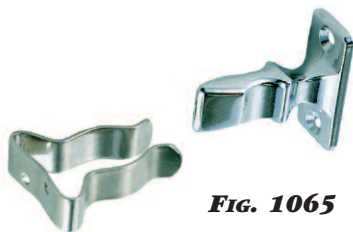

**FIG. 1065**

- CONSTRUCTION:**  
 \* STAINLESS STEEL CLIP  
 \* CHROME PLATED ZINC ALLOY ARROW



**ORDERING INFORMATION**

Dimensions Arrow Base Inches	Dimensions Clip Base Inches	Projection Inches	Dealer Pkg. - 5 Cards 1 Pc. per Card	Screw Size	Weight Ounces
1-5/8 x 3/4	1-3/8 x 7/16	1-3/4	1065 DP CHR	8	2

## DOOR CATCHES & BUTTONS

**FIG. 554 - DOOR CATCH**

**CONSTRUCTION:**

- \* **WHITE PLASTIC**
- \* **STAINLESS STEEL MOUNTING & KEEPER SCREWS**



**FIG. 554**



**ORDERING INFORMATION**

Screw Size	Dimensions Catch	Dealer Pkg. 25 Cards 2 Pcs. per Card	OEM Bulk Pkg. 100 Pcs.	Mounting Screw Size	Weight per 50 Ounces
3/4 x #8	1-1/4 x 5/8	554 DP	554	4 R.H.	4



**FIG. 559 - DOOR CATCH**

**CONSTRUCTION:**

- \* **BLACK PLASTIC**



**FIG. 559**



**ORDERING INFORMATION**

Dimensions Stud	Dimensions Catch	Dealer Pkg. 25 Cards 2 Pcs. per Card	OEM Bulk Pkg. 100 Pcs.	Screw Size	Weight per 50 Ounces
1-1/8 x 3/8	1-3/8 x 7/8	559 DP	559	4 R.H.	4



**FIGS. 1216 & 1217 - DOOR BUTTONS**

**CONSTRUCTION:**

- \* **CHROME PLATED ZINC ALLOY**
- \* **BLACK PLASTIC BUTTON**

Fig. 1216 - Supplied with Phosphor Bronze Tension Spring.

Fig. 1217 - Supplied without Spring and Requires a No. 8 Oval-Head Pivot Screw.



**FIG. 1216**



**FIG. 1217**



**ORDERING INFORMATION**

Type	O.D. Overall Inches	Dealer Pkg. 10 Cards 1 Pc. per Card	OEM Bulk Pkg. 50 Pcs.	Screw Size	Weight Ounces
With Spring	1-3/4	1216 DP CHR	1216 000 CHR	6	1-1/2
W/O Spring	1-3/4	1217 DP CHR	1217 000 CHR	6	1-1/2

Spare Button for Both, Cat. No. 1216 000 99A.



## LOCK & LATCH SETS



# GET THE LOCKS & LATCHES THAT LOOK & PERFORM AS WELL AS YOUR BOAT

**Get The "T-Handle"**  
FIG. 1091 & 1092 SERIES

**Get The "Contemporary"**  
FIG. 710 & 711 SERIES

★ **VERSATILE**

OPEN OR CLOSED, THE "T" HANDLE LAYS FLAT IN MOST CAM POSITIONS

BLACK OR WHITE PLASTIC BODY, CHROME OR PLASTIC HANDLE



★ **RUGGED & EASY TO OPEN**

"T" HANDLE ACCOMMODATES THE LARGEST GLOVED HAND



★ **KEEPS LOCKERS DRY**

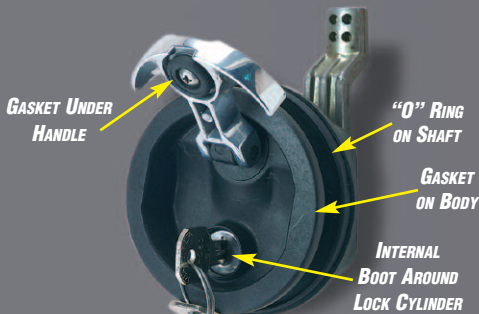

4 DIFFERENT SEALS PREVENT LEAKS

SILKY SMOOTH MECHANISM

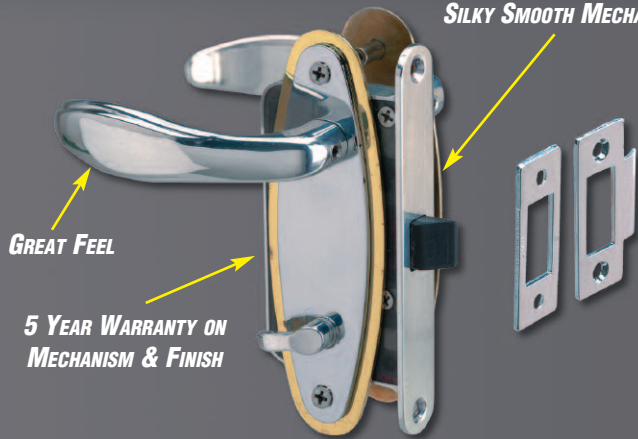

GREAT FEEL

5 YEAR WARRANTY ON MECHANISM & FINISH

★ **MODERN STYLING**

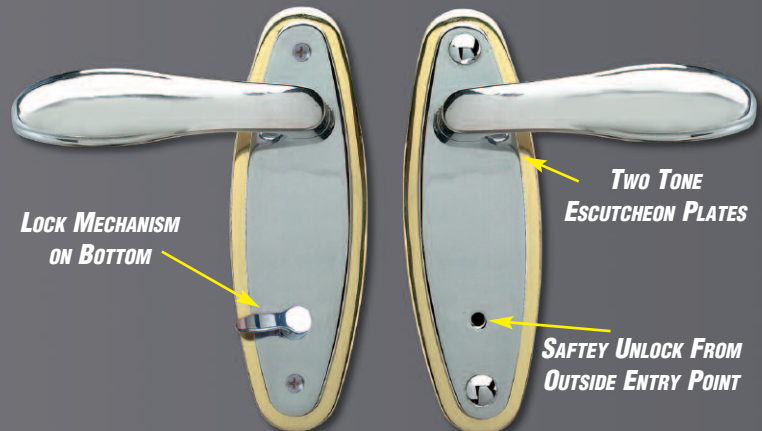

LOCK MECHANISM ON BOTTOM

TWO TONE ESCUTCHEON PLATES

SAFETY UNLOCK FROM OUTSIDE ENTRY POINT

## "T" - HANDLE FLUSH LOCK & LATCH

**FIGS. 1091 & 1092 - FLUSH LOCK & LATCH FOR SMOOTH AND CARPETED SURFACES  
(GASKET INCLUDED FOR SMOOTH SURFACE APPLICATIONS)**

**FIG. 1091 #1  
BLK/CHR**

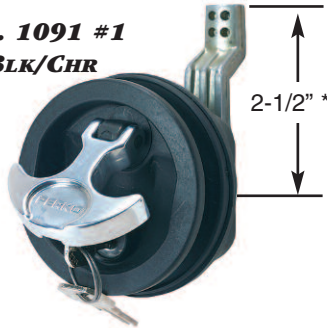

**CONSTRUCTION OPTIONS:**  
 \* BLACK OR WHITE PLASTIC BODY  
 \* CHROME PLATED ZINC ALLOY, BLACK OR WHITE PLASTIC "T" HANDLE  
 \* STAINLESS STEEL STEM

**FIG. 1091  
BLACK #1**

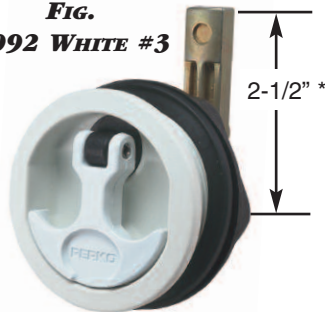

**FIG. 1091 - LOCK WITH 2 KEYS  
FIG. 1092 - LATCH (NON-LOCKING)**

No. 1 with Offset Cam Bar  
No. 3 with Straight Cam Bar

Easily Installs in a 2-1/2 Inch Diameter Hole.  
For Mounting Surfaces 1/8 to 3/4 Inches Thick.

**FIG.  
1092 WHITE #3**



THE T-HANDLE DROPS DOWN FLUSH IN EITHER THE OPEN OR CLOSED (180° ROTATION) POSITION  
(EXCEPT WITH THE OFFSET CAM BAR POSITIONED UPWARD).



**FULLY WATER PROOF.**  
THE RUBBER SEAL & BOOT UNDER THE T-HANDLE SEALS THE LOCK CYLINDER PREVENTING WATER INTRUSION.

SEE PAGE 181 FOR MATCHING  
"T" HANDLE PULLS



### ORDERING INFORMATION

Body Color	Handle Color	Type	Adjustment Cam Bar Inches	Dimensions Face Plate Inches	OEM Bulk Pkg. 25 Pcs.	Dealer Pkg. 5 Cards 1 Pc. per Card	Weight Ounces
Black	Chr. Plated	Lock	3/4 to 2-3/8	3" Dia.	1091 001 BLK	1091 DP1 BLK	8
Black	Chr. Plated	Lock	1-1/4 to 1-7/8	3" Dia.	1091 003 BLK	1091 DP3 BLK	8
Black	Chr. Plated	Latch	3/4 to 2-3/8	3" Dia.	1092 001 BLK	1092 DP1 BLK	8
Black	Chr. Plated	Latch	1-1/4 to 1-7/8	3" Dia.	1092 003 BLK	1092 DP3 BLK	8
White	Chr. Plated	Lock	3/4 to 2-3/8	3" Dia.	1091 001 WHT	1091 DP1 WHT	8
White	Chr. Plated	Lock	1-1/4 to 1-7/8	3" Dia.	1091 003 WHT	1091 DP3 WHT	8
White	Chr. Plated	Latch	3/4 to 2-3/8	3" Dia.	1092 001 WHT	1092 DP1 WHT	8
White	Chr. Plated	Latch	1-1/4 to 1-7/8	3" Dia.	1092 003 WHT	1092 DP3 WHT	8
Black	Black Plastic	Lock	3/4 to 2-3/8	3" Dia.	1091 B01 BLK	-----	8
Black	Black Plastic	Lock	1-1/4 to 1-7/8	3" Dia.	1091 B03 BLK	-----	8
Black	Black Plastic	Latch	3/4 to 2-3/8	3" Dia.	1092 B01 BLK	-----	8
Black	Black Plastic	Latch	1-1/4 to 1-7/8	3" Dia.	1092 B03 BLK	-----	8
White	White Plastic	Lock	3/4 to 2-3/8	3" Dia.	1091 W01 WHT	-----	8
White	White Plastic	Lock	1-1/4 to 1-7/8	3" Dia.	1091 W03 WHT	-----	8
White	White Plastic	Latch	3/4 to 2-3/8	3" Dia.	1092 W01 WHT	-----	8
White	White Plastic	Latch	1-1/4 to 1-7/8	3" Dia.	1092 W03 WHT	-----	8

Spare Offset Cam Bar, Cat. No. 1091 001 99A. Spare Straight Cam Bar, Cat. No. 1091 003 99A.  
\* Measurements are from the center of the lockset to the top of the cam bar.

## FLUSH LOCKS & LATCHES

### FIGS. 931 & 932 - FLUSH LOCK & LATCH

#### CONSTRUCTION OPTIONS:

- \* BLACK OR WHITE PLASTIC
- \* CHROME PLATED ZINC ALLOY
- \* STAINLESS STEEL STEM AND LOCK NUT

**FLEXIBLE  
PLASTIC  
STRIKE**



**FIG. 931 - LOCK WITH 2 KEYS**

**FIG. 932 - LATCH (NON-LOCKING)**

- No. 1 with Offset Cam Bar and Flexible Plastic Strike Plate
- No. 2 with Offset Adjustable Cam Bar
- No. 3 with Straight Cam Bar and Flexible Plastic Strike Plate

Detents Indicate Open or Closed Position. Easily Installs in a 2 Inch Diameter Hole. For Door Thickness 1/4 to 1-1/8 Inches.



**FIG.  
931 #1 BLK**



**FIG.  
932 #2 BLK**



**FIG.  
931 #3 BLK**



### ORDERING INFORMATION

Finish	Type	Adjustment Cam Bar Inches	Dimensions Face Plate Inches	Dealer Pkg. - 5 Cards 1 Pc. per Card	OEM Bulk Pkg. 25 Pcs.	Weight Ounces
Black	Lock	3/8 to 3	2-1/2 x 2-1/2	931 DP1 BLK	931 001 BLK	8
Black	Lock	3/8 to 3	2-1/2 x 2-1/2	931 DP2 BLK	931 002 BLK	8-1/2
Black	Lock	1-1/16 to 2-9/16	2-1/2 x 2-1/2	931 DP3 BLK	931 003 BLK	6
Black	Latch	3/8 to 3	2-1/2 x 2-1/2	932 DP1 BLK	932 001 BLK	7
Black	Latch	3/8 to 3	2-1/2 x 2-1/2	932 DP2 BLK	932 002 BLK	7-1/2
Black	Latch	1-1/16 to 2-9/16	2-1/2 x 2-1/2	932 DP3 BLK	932 003 BLK	7
White	Lock	3/8 to 3	2-1/2 x 2-1/2	931 DP1 WHT	931 001 WHT	8
White	Lock	3/8 to 3	2-1/2 x 2-1/2	931 DP2 WHT	931 002 WHT	8-1/2
White	Lock	1-1/16 to 2-9/16	2-1/2 x 2-1/2	931 DP3 WHT	931 003 WHT	6
White	Latch	3/8 to 3	2-1/2 x 2-1/2	932 DP1 WHT	932 001 WHT	7
White	Latch	3/8 to 3	2-1/2 x 2-1/2	932 DP2 WHT	932 002 WHT	7-1/2
White	Latch	1-1/16 to 2-9/16	2-1/2 x 2-1/2	932 DP3 WHT	932 003 WHT	7

Spare Offset Cam Bar, Cat. No. 931 001 99A.  
Spare Straight Cam Bar, Cat. No. 931 003 99A.

Spare Offset Adjustable Cam Bar, Cat. No. 931 002 99A.

### FIG. 1089 - LOCK & LATCH COVER

#### CONSTRUCTION OPTIONS:

- \* BLACK OR WHITE FIBER REINFORCED PLASTIC HINGED, WATER RESISTANT
- No. 1 - FITS FIGS. 931 AND 932**



### ORDERING INFORMATION

Finish	Fits Fig. No.	Overall Dimensions	Dealer Pkg. - 5 Cards 1 Pc. per Card	OEM Bulk Pkg. 25 Pcs.	Weight Ounces
Black	931/932	2-3/4 x 3-1/4	1089 DP1 BLK	1089 001 BLK	2
White	931/932	2-3/4 x 3-1/4	1089 DP1 WHT	1089 001 WHT	2



**FIG. 1089**



## FLUSH LOCKS & LATCHES

**Figs. 1071 & 1072 - FLUSH LOCK & LATCH FOR CARPETED SURFACES**

**Figs. 1081 & 1082 - FLUSH LOCK & LATCH FOR SMOOTH OR CARPETED SURFACES**

**(GASKET INCLUDED FOR SMOOTH SURFACE APPLICATIONS)**

**CONSTRUCTION OPTIONS:**

- \* BLACK OR WHITE PLASTIC
- \* STAINLESS STEEL "D" RING HANDLE
- \* STEM AND LOCK NUT
- \* TWO O-RINGS FOR INCREASED WATER RESISTANCE
- \* POSITION INDICATOR SHOWS OPEN OR CLOSED POSITION

**FLEXIBLE  
PLASTIC  
STRIKE**



**FIG. 1071 - LOCK WITH 2 KEYS**  
**FIG. 1072 - LATCH (NON-LOCKING)**

**FIG. 1081 - LOCK WITH 2 KEYS**  
**FIG. 1082 - LATCH (NON-LOCKING)**

- No. 1 with Offset Cam Bar and Flexible Plastic Strike Plate
- No. 2 with Offset Adjustable Cam Bar
- No. 3 with Straight Cam Bar and Flexible Plastic Strike Plate

Easily Installs in a 2-3/8 Inch Diameter Hole.  
For Mounting Surfaces 3/8 to 7/8 Inches Thick.



**FIG.**  
**1071 #1 BLK**



**FIG.**  
**1072 #2 BLK**



**FIG.**  
**1081 #3 BLK**



### ORDERING INFORMATION

Finish	Type	Adjustment Cam Bar Inches	Dimensions Face Plate Inches	Figs. 1071/1072 OEM Bulk Pkg. 25 Pcs.	Figs. 1081/1082 Dealer Pkg. - 5 Cards 1 Pc. per Card	Figs. 1081/1082 OEM Bulk Pkg. 25 Pcs.	Weight Ounces
Black	Lock	3/8 to 3	2-7/8 x 2-7/8	1071 001 BLK	1081 DP1 BLK	1081 001 BLK	8
Black	Lock	3/8 to 3	2-7/8 x 2-7/8	1071 002 BLK	1081 DP2 BLK	1081 002 BLK	8-1/2
Black	Lock	1-1/16 to 2-9/16	2-7/8 x 2-7/8	1071 003 BLK	1081 DP3 BLK	1081 003 BLK	6
Black	Latch	3/8 to 3	2-7/8 x 2-7/8	1072 001 BLK	1082 DP1 BLK	1082 001 BLK	7
Black	Latch	3/8 to 3	2-7/8 x 2-7/8	1072 002 BLK	1082 DP2 BLK	1082 002 BLK	7-1/2
Black	Latch	1-1/16 to 2-9/16	2-7/8 x 2-7/8	1072 003 BLK	1082 DP3 BLK	1082 003 BLK	7
White	Lock	3/8 to 3	2-7/8 x 2-7/8	1071 001 WHT	1081 DP1 WHT	1081 001 WHT	8
White	Lock	3/8 to 3	2-7/8 x 2-7/8	1071 002 WHT	1081 DP2 WHT	1081 002 WHT	8-1/2
White	Lock	1-1/16 to 2-9/16	2-7/8 x 2-7/8	1071 003 WHT	1081 DP3 WHT	1081 003 WHT	6
White	Latch	3/8 to 3	2-7/8 x 2-7/8	1072 001 WHT	1082 DP1 WHT	1082 001 WHT	7
White	Latch	3/8 to 3	2-7/8 x 2-7/8	1072 002 WHT	1082 DP2 WHT	1082 002 WHT	7-1/2
White	Latch	1-1/16 to 2-9/16	2-7/8 x 2-7/8	1072 003 WHT	1082 DP3 WHT	1082 003 WHT	7

Spare Offset Cam Bar, Cat. No. 931 001 99A.  
Spare Straight Cam Bar, Cat. No. 931 003 99A.

Spare Offset Adjustable Cam Bar, Cat. No. 931 002 99A.

## FLUSH LOCKS & LATCHES, FLUSH HATCH DOG

**FIGS. 1031 & 1032 - FLUSH LOCK & LATCH**

**CONSTRUCTION OPTIONS:**

- \* BLACK OR WHITE PLASTIC
  - \* CHROME PLATED ZINC ALLOY
  - \* STAINLESS STEEL STEM AND LOCK NUT
  - \* LARGE HANDLE ALLOWS TWO FINGER GRIP
- FIG. 1031 - LOCK WITH 2 KEYS**  
**FIG. 1032 - LATCH (NON-LOCKING)**

Flush Mounts in a 2-3/8 x 2-3/8 Inch Hole.  
 Surface Mounts in a 1-5/8 Inch Diameter Hole  
 With Plastic Spacer Included.  
 For Door Thickness 1/8 to 3/4 Inches.



**FIG. 1031**

**FIG. 1032**

**ORDERING INFORMATION**

Finish	Type	Adjustment Cam Bar Inches	Dimensions Face Plate Inches	Dealer Pkg. 5 Cards 1 Pc. per Card	OEM Bulk Pkg. 25 Pcs.	Weight Ounces
Black	Lock	1/2 to 3	3-1/8 x 3-1/8	1031 DP1 BLK	1031 001 BLK	10
Black	Latch	1/2 to 3	3-1/8 x 3-1/8	1032 DP1 BLK	1032 001 BLK	10
White	Lock	1/2 to 3	3-1/8 x 3-1/8	1031 DP1 WHT	1031 001 WHT	10
White	Latch	1/2 to 3	3-1/8 x 3-1/8	1032 DP1 WHT	1032 001 WHT	10

**FIG. 1089 - LOCK & LATCH COVER**

**CONSTRUCTION OPTIONS:**

- \* BLACK OR WHITE FIBER REINFORCED PLASTIC. HINGED, WATER RESISTANT
- No. 3 - FITS FIGS. 1031 AND 1032**



**FIG. 1089**

**ORDERING INFORMATION**

Finish	Fits Fig. No.	Overall Dimensions	Dealer Pkg. - 5 Cards 1 Pc. per Card	OEM Bulk Pkg. 25 Pcs.	Weight Ounces
Black	1031/1032	3-1/4 x 3-3/4	1089 DP3 BLK	1089 003 BLK	3
White	1031/1032	3-1/4 x 3-3/4	1089 DP3 WHT	1089 003 WHT	3

**FIG. 777 - FLUSH HATCH DOG**

**CONSTRUCTION:**

- \* CHROME PLATED BRASS
- \* STAINLESS STEEL LOCK NUTS
- \* WITH FLUSH STRIKE
- \* "O" RING SEALS FOR WATER RESISTANCE
- \* DOES NOT RATTLE WHEN "DOGGED" DOWN

For Securely  
 "Dogging" (Fastening) Deck Hatches.

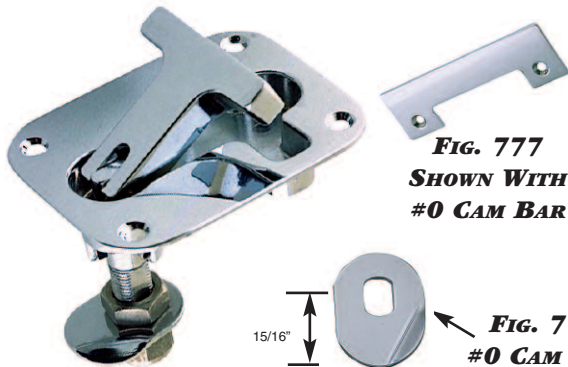

**FIG. 777**  
 SHOWN WITH  
 #0 CAM BAR



**FIG. 777**  
 #0 CAM BAR

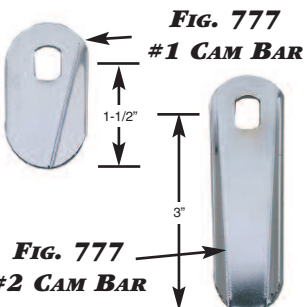

**FIG. 777**  
 #1 CAM BAR

**FIG. 777**  
 #2 CAM BAR

**ORDERING INFORMATION**

For Max. Hatch Thickness Inches	Adjustment Cam Bar Inches	Dimensions Face Plate Inches	Standard Pkg. - 1 Pc. OEM Pkg. - 5 Pcs.	Screw Size	Weight Ounces
2	1-1/4 to 2	3-13/16 x 3	777 000 CHR	8	14
2	1-1/4 to 2	3-13/16 x 3	777 001 CHR	8	14
2	1-1/4 to 2	3-13/16 x 3	777 002 CHR	8	14

Spare Cam Bar for Size #0, Cat No. 777 000 99A. Spare Cam Bar for Size #1, Cat No. 777 001 99A. Spare Cam Bar for Size #2, Cat No. 777 002 99A.

## LOCK & LATCH SET SELECTION GUIDE

Series	Type	Size	Mounting Surface Thickness	Lock & Latch Set Features	Page
931	Lock	2-1/2" x 2-1/2"	1/4" to 1-1/8"	Available Black or White; #1 Offset Cam Bar; #2 Offset Adjustable Cam Bar; #3 Straight Cam Bar. Adjustable 3/8" to 3", used on doors etc.	168
932	Latch				
1071	Lock	2-7/8" x 2-7/8"	3/8" to 1-1/4"	Available Black or White; #1 Offset Cam Bar; #2 Offset Adjustable Cam Bar; #3 Straight Cam Bar. Used on carpeted surfaces. Adjustable 3/8" to 3". Stainless Steel Handle.	169
1072	Latch				
1081	Lock	2-7/8" x 2-7/8"	3/8" to 1-1/4"	Available Black or White; #1 Offset Cam Bar; #2 Offset Adjustable Cam Bar; #3 Straight Cam Bar. Used on smooth or carpeted surfaces. Adjustable 3/8" to 3". Stainless Steel Handle.	169
1082	Latch				
1031	Lock	3-1/8" x 3-1/8"	1/8" to 3/4"	Available Black or White. Offset Cam Bar only; Adjustable 1/2" to 3". Extra large handle.	170
1032	Latch				
1091	Lock	3" x 3"	1/8" to 3/4"	Available Black or White. #1 Offset Cam Bar; #3 Straight Cam Bar. Used on Smooth or Carpeted Surfaces. Adjustable 3/8" to 3". Chrome Plated Zinc Alloy "T" Handle	167
1092	Latch				

**#1 Style Cam Bar\*\***

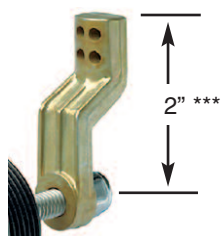

e.g. 931 #1  
Offset Cam Bar  
with Flexible  
Plastic Strike\*

**#2 Style Cam Bar\*\***

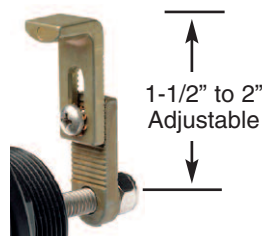

e.g. 931 #2  
Offset Adjustable  
Cam Bar.

**#3 Style Cam Bar\*\***

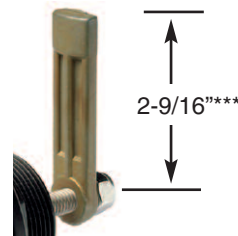

e.g. 931 #3  
Straight Cam Bar  
with Flexible  
Plastic Strike\*

**Heavy Duty  
#1 Style Cam Bar\*\***

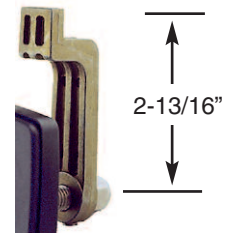

e.g. 1031 #1  
Heavy Duty Offset  
Cam Bar as used on  
1031/1032 Strikes

\* Flexible Plastic Strike Not Included with Fig Nos. 1091 & 1092, 1031, 1032.

\*\* Measurements are from the center of the lockset to the top of the cam bar.

\*\*\*See Page 167 For Proper measurements for the #1 & #3 Style Cam bars for Figs 1091/1092.

## FLUSH LOCK & LATCH

**FIG. 921  
SHOWN**



**FIGS. 921 & 922 - FLUSH LOCK & LATCH**

**CONSTRUCTION:**

**\* CHROME PLATED ZINC ALLOY**

**FIG. 921 - LOCKING LATCH WITH 2 KEYS**

**FIG. 922 - NON-LOCKING LATCH**

Easily Installs in a 1-5/8 Inch Diameter Hole.

For Door Thickness 1/2 to 3/4 Inches.



**ORDERING INFORMATION**

Type	Dimensions Face Plate Inches	Dealer Pkg. - 5 Cards 1 Pc. per Card	OEM Bulk Pkg. 25 Pcs.	Weight Ounces
Lock	2-1/4 x 2	921 DP CHR	921 000 CHR	6-1/2
Latch	2-1/4 x 2	922 DP CHR	922 000 CHR	6

Spare Chrome Cam Bar, Cat. No. 980A.

Note: Chrome and Plastic Cam Bars are not interchangeable.

## LOCK & LATCH SETS

**DETERMINING THE BEVEL REQUIRED ON A LOCK OR LATCH.**

**WHEN STANDING OUTSIDE**

**IF THE DOOR OPENS AWAY FROM YOU, THEN YOU NEED A LOCK OR LATCH WITH A REGULAR BEVEL.**

**IF THE DOOR OPENS TOWARD YOU, THEN YOU NEED A LOCK OR LATCH WITH A REVERSE BEVEL.**

**DOOR OPENING INWARD.**



Right Hand Door Showing Regular Bevel Lock With Interchangeable Knob and Lever.

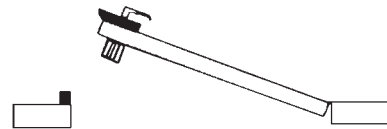

Left Hand Door Showing Regular Bevel Lock With Non-Interchangeable Knob and Lever.

**DOOR OPENING OUTWARD.**



Right Hand Door Showing Reverse Bevel Lock With Interchangeable Knob and Lever.



Left Hand Door Showing Reverse Bevel Lock With Non-Interchangeable Knob and Lever.

**ALL PERKO LOCK AND LATCH SETS MAY BE USED ON EITHER RIGHT OR LEFT HAND DOORS.**

## LOCKS & LATCHES

### FIGS. 710 & 711- LATCH SETS

#### PRIVACY LATCHES FOR INTERIOR CABINS AND HEAD ENCLOSURES

Locks by Turn Button from Inside.

#### CONSTRUCTION:

- \* CHROME PLATED ZINC ALLOY
- \* BRASS & PLASTIC
- \* NEW CONTEMPORARY STYLING
- \* TWO TONE ESCUTCHEON PLATES (ON MORTISE TYPE)
- \* OVERALL HEIGHT - 5-1/4 INCHES
- \* SAFETY UNLOCK FROM OUTSIDE
- \* INTERIOR LOCK MECHANISM

#### FIG. 710 - MORTISE LATCH SET

For Door Thickness 3/4 to 1-1/2 Inches

#### FIG. 711 - FLUSH LATCH SET

For Door Thickness 1/2 to 3/4 Inches

**NEW  
PRODUCT**



FIG. 710  
MORTISE TYPE



FIG. 711  
FLUSH TYPE



FIG. 710



### ORDERING INFORMATION

Latch Type	For Door Thickness Inches	Dealer Pkg. 5 Sets 1 Set per Card	OEM Bulk Pkg. 10 Sets	Approximate Weight in Pounds
Mortise	3/4 to 1	710 DP1 CHR	710 001 CHR	1-1/2
Mortise	1 to 1-1/4	710 DP2 CHR	710 002 CHR	1-1/2
Mortise	1-1/4 to 1-1/2	710 DP3 CHR	710 003 CHR	1-1/2
Flush	1/2	711 DP1 CHR	711 001 CHR	1-1/2
Flush	5/8	711 DP2 CHR	711 002 CHR	1-1/2
Flush	3/4	711 DP3 CHR	711 003 CHR	1-1/2

## LATCH SETS

### FIGS. 1239 & 1240 - FLUSH CUP RIM LATCH SETS

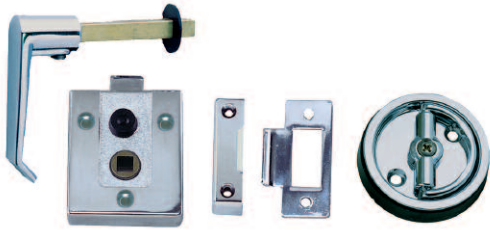

**FIGS. 1239 & 1240**

**CONSTRUCTION:**

- \* CHROME PLATED ZINC ALLOY
- \* SLIDING LOCK BUTTON

**FIG. 1239 - REGULAR BEVEL WITH BOX STRIKE**

**FIG. 1240 - REVERSE BEVEL WITH FLUSH STRIKE**

Supplied with Black Plastic Spacer For Surface Mounting.  
For Door Thickness 5/8 to 1 Inch.



**ORDERING INFORMATION**

Bevel Type	Dimensions Case Inches	O.D. Cup Inches	Dealer Pkg. 5 Sets 1 Set per Pkg.	OEM Bulk Pkg. 10 Sets	Weight Pounds
Regular	2 x 2-1/4	2-1/4	1239 DP CHR	1239 000 CHR	1
Reverse	2 x 2-1/4	2-1/4	1240 DP CHR	1240 000 CHR	1

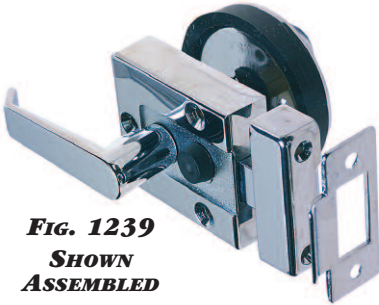

**FIG. 1239 SHOWN ASSEMBLED**

Case and Cup Both, Screw Size #8. Spare Box Strike, Cat. No. 977 000 CHR.  
Spare Regular Bevel w/Cam, Cat. No. 984 000 CHR. Spare Flush Strike, Cat. No. 912 DP CHR.  
Spare Reverse Bevel w/Cam, Cat. No. 920 DP CHR.

### FIGS. 991 & 992 - FLUSH LATCH SETS

**CONSTRUCTION:**

- \* CHROME PLATED ZINC ALLOY
- \* SLIDING LOCK BUTTON

For Door Thickness 1/2 to 3/4 Inches.

**FIG. 991 - REGULAR BEVEL WITH FLUSH STRIKE**

**FIG. 992 - REVERSE BEVEL WITH FLUSH STRIKE**

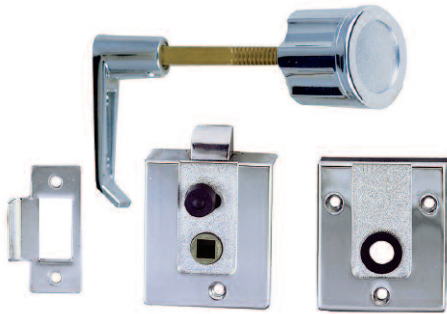

**FIGS. 991 & 992**

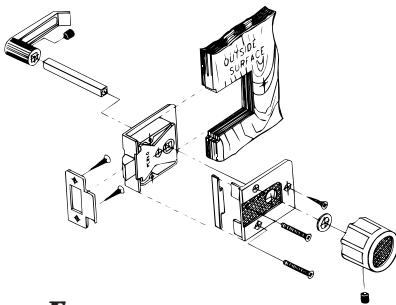

**EXPLODED VIEW SHOWS FIG. 992**

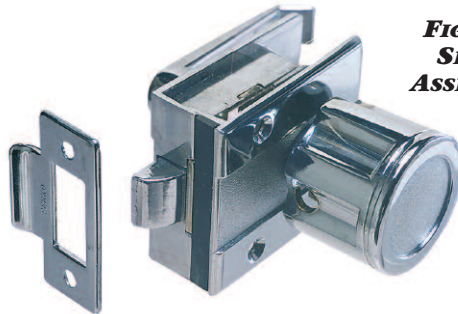

**FIG. 991 SHOWN ASSEMBLED**



**ORDERING INFORMATION**

Bevel Type	Dimensions Case Inches	Dimensions Escutcheon Inches	Dealer Pkg. 5 Sets 1 Set per Pkg.	OEM Bulk Pkg. 10 Sets	Screw Size	Weight Pounds
Regular	1-5/8 x 1-5/8	2 x 2-1/4	991 DP CHR	991 000 CHR	6	1
Reverse	1-5/8 x 1-5/8	2 x 2-1/4	992 DP CHR	992 000 CHR	6	1

Spare Flush Strike, Cat. No. 912 DP CHR. Spare Regular Bevel with Cam, Cat. No. 984 000 CHR.  
Spare Knob and Handle, Cat. No. 995 000 CHR. Spare Reverse Bevel with Cam, Cat. No. 920 DP CHR.

## LATCH SETS

### *FIGS. 929 & 1029 - RIM LATCH SET*

**CONSTRUCTION:**

- \* **CHROME PLATED ZINC ALLOY**
- \* **SLIDING LOCK BUTTON**

For Door Thickness 1/2 to 1 Inch.

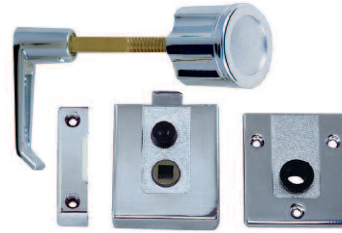

**FIGS. 929 & 1029**

**FIG. 929 - REGULAR BEVEL WITH BOX STRIKE**  
**FIG. 1029 - REVERSE BEVEL WITH BOX STRIKE**



**FIG. 929  
SHOWN  
ASSEMBLED**



### **ORDERING INFORMATION**

Bevel Types	Dimensions Case Inches	Dimensions Escutcheon Inches	Dealer Pkg. 5 Sets 1 Set per Card	OEM Bulk Pkg. 10 Sets	Screw Size	Weight Pounds
Regular	2 x 2-1/4	2 x 2-1/4	929 DP CHR	929 000 CHR	6	3/4
Reverse	2 x 2-1/4	2 x 2-1/4	1029 DP CHR	1029 000 CHR	6	3/4

Spare Box Strike, Cat. No. 977 000 CHR.

Spare Regular Bevel with Cam, Cat. No. 984 000 CHR.

Spare Knob and Handle Assembly, Cat. No. 995 000 CHR.

Spare Reverse Bevel with Cam, Cat. No. 920 DP CHR.

### *FIGS. 968 & 1068 - RIM LATCH SET*

**CONSTRUCTION:**

- \* **CHROME PLATED ZINC ALLOY**
- \* **SLIDING LOCK BUTTON**

For Door Thickness 1/2 to 1 Inch.

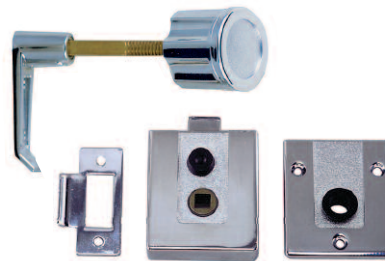

**FIGS. 968 & 1068**

**FIG. 968 - REGULAR BEVEL WITH FLUSH STRIKE**  
**FIG. 1068 - REVERSE BEVEL WITH FLUSH STRIKE**

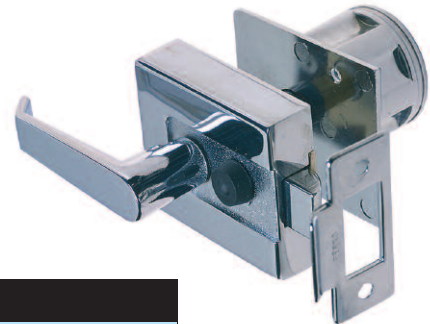

**FIG. 968  
SHOWN  
ASSEMBLED**



### **ORDERING INFORMATION**

Bevel Types	Dimensions Case Inches	Dimensions Escutcheon Inches	Dealer Pkg. 5 Sets 1 Set per Card	OEM Bulk Pkg. 10 Sets	Screw Size	Weight Pounds
Regular	2 x 2-1/4	2 x 2-1/4	968 DP CHR	968 000 CHR	6	3/4
Reverse	2 x 2-1/4	2 x 2-1/4	1068 DP CHR	1068 000 CHR	6	3/4

Spare Flush Strike, Cat. No. 912 DP CHR.

Spare Regular Bevel with Cam, Cat. No. 984 000 CHR.

Spare Knob and Handle Assembly, Cat. No. 995 000 CHR.

Spare Reverse Bevel with Cam, Cat. No. 920 DP CHR.

## LATCH & LOCK SETS

### FIGS. 918 & 919 - RIM LOCK SET

#### CONSTRUCTION:

\* **CHROME PLATED ZINC ALLOY**

For Door Thickness 5/8 to 1-3/8 Inches

**FIG. 918 - REGULAR BEVEL WITH BOX STRIKE**

**FIG. 919 - REVERSE BEVEL WITH FLUSH STRIKE**

Locks by Turn Button from Inside or Key from Outside



**FIG. 918  
SHOWN  
ASSEMBLED**

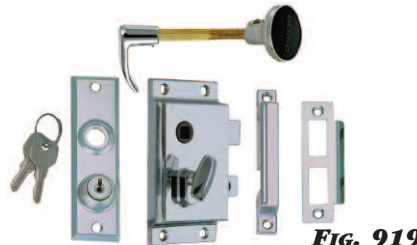

**FIG. 919  
FIG. 918**



#### ORDERING INFORMATION

Door Bevel/Strike Type	Dimensions Case Inches	Dimensions Escutcheon Inches	Dealer Pkg. 5 Sets 1 Set per Card	OEM Bulk Pkg. 10 Sets	Screw Size	Weight Pounds
Regular w/Box	3-7/8 x 2	4-3/8 x 1-1/4	918 DP CHR	918 000 CHR	6	1-1/4
Reverse w/Flush	3-7/8 x 2	4-3/8 x 1-1/4	919 DP CHR	919 000 CHR	6	1-1/4

Spare Box Strike, Cat. No. 918 000 99A.

Spare Flush Strike, Cat. No. 913 DP CHR.

Spare Knob and Handle Assembly, Cat. No. 962 000 CHR.

Spare Regular Bevel with Cam, Cat. No. 984 000 CHR.

Spare Reverse Bevel with Cam, Cat. No. 920 DP CHR.

Spare Escutcheon Plate with Keys, Cat. No. 953 000 CHR.

### FIGS. 1279 & 1280 - FLUSH CUP RIM LATCH SET

#### CONSTRUCTION:

\* **CHROME PLATED ZINC ALLOY**

\* **SLIDING LOCK BUTTON**

For Door Thickness 3/4 to 1-1/8 Inches.

**FIG. 1279 - REGULAR BEVEL WITH BOX STRIKE**

**FIG. 1280 - REVERSE BEVEL WITH FLUSH STRIKE**

Supplied with Black Plastic Spacer for Surface Mounting

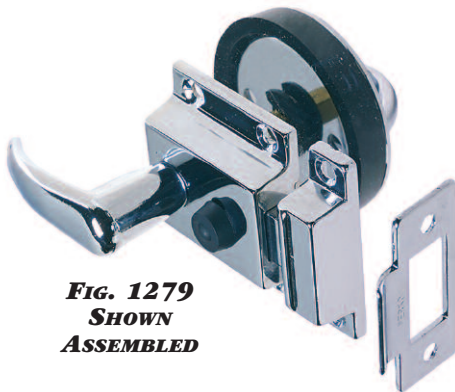

**FIG. 1279  
SHOWN  
ASSEMBLED**



**FIG. 1279**

**FIG. 1280**



#### ORDERING INFORMATION

Bevel/Strike Type	Dimensions Case Inches	O.D. Cup Inches	Dealer Pkg. - 5 Sets 1 Set per Card	OEM Bulk Pkg. 10 Sets	Weight Pounds
Regular w/Box	2-1/8 x 1-3/4	2 x 2-1/4	1279 DP CHR	1279 000 CHR	1
Reverse w/Flush	2-1/8 x 1-3/4	2 x 2-1/4	1280 DP CHR	1280 000 CHR	1

Case Screw Size #6

Spare Box Strike, Cat. No. 976 000 CHR.

Spare Flush Strike, Cat. No. 912 DP CHR.

Cup Screw Size #8

Spare Regular Bevel with Cam, Cat. No. 984 000 CHR.

Spare Reverse Bevel with Cam, Cat. No. 920 DP CHR.



## LATCH SETS

### ***Figs. 928 & 1028 - RIM LATCH SET***

**CONSTRUCTION:**

- \* **CHROME PLATED ZINC ALLOY**
- \* **SLIDING LOCK BUTTON**

For Door Thickness 5/8 to 1-3/8 Inches

**FIG. 928 - REGULAR BEVEL WITH BOX STRIKE**  
**FIG. 1028 - REVERSE BEVEL WITH BOX STRIKE**



**Figs. 928 & 1028**

**FIG. 928  
SHOWN  
ASSEMBLED**



### **ORDERING INFORMATION**

Bevel Type	Dimensions Case	Dimensions Escutcheon	Dealer Pkg.	OEM	Screw Size	Weight Pounds
	Inches	Inches	5 Sets 1 Set per Card	Bulk Pkg. 10 Sets		
Regular	2-1/8 x 1-3/4	4-3/8 x 1-1/4	928 DP CHR	928 000 CHR	6	3/4
Reverse	2-1/8 x 1-3/4	4-3/8 x 1-1/4	1028 DP CHR	1028 000 CHR	6	3/4

Spare Box Strike, Cat. No. 976 000 CHR.

Spare Regular Bevel with Cam, Cat. No. 984 000 CHR.

Spare Knob and Handle Assembly, Cat. No. 962 000 CHR.

Spare Reverse Bevel with Cam, Cat. No. 920 DP CHR.

### ***Figs. 930 & 1030 - RIM LATCH SET***

**CONSTRUCTION:**

- \* **CHROME PLATED ZINC ALLOY**
- \* **SLIDING LOCK BUTTON**

For Door Thickness 5/8 to 1-3/8 Inches

**FIG. 930 - REVERSE BEVEL WITH FLUSH STRIKE**  
**FIG. 1030 - REGULAR BEVEL WITH FLUSH STRIKE**



**Figs. 930 & 1030**

**FIG. 930  
SHOWN  
ASSEMBLED**



### **ORDERING INFORMATION**

Bevel Type	Dimensions Case	Dimensions Escutcheon	Dealer Pkg.	OEM	Screw Size	Weight Pounds
	Inches	Inches	5 Sets 1 Set per Card	Bulk Pkg. 10 Sets		
Reverse	2-1/8 x 1-3/4	4-3/8 x 1-1/4	930 DP CHR	930 000 CHR	6	3/4
Regular	2-1/8 x 1-3/4	4-3/8 x 1-1/4	1030 DP CHR	1030 000 CHR	6	3/4

Spare Flush Strike, Cat. No. 912 DP CHR.

Spare Regular Bevel with Cam, Cat. No. 984 000 CHR.

Spare Knob and Handle Assembly, Cat. No. 962 000 CHR.

Spare Reverse Bevel with Cam, Cat. No. 920 DP CHR.

## LATCH & LOCK SETS

**FIG. 927**  
SHOWN  
ASSEMBLED



**FIG. 927**

**FIG. 927 - MORTISE LOCK SET**

**CONSTRUCTION:**

\* **CHROME PLATED ZINC ALLOY**

Locked by Turn Button from Inside or  
Key from Outside  
Bevel can be Reversed During Installation

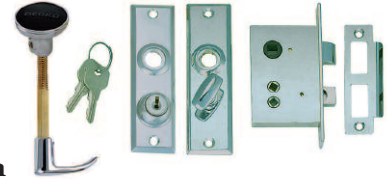

**ORDERING INFORMATION**

For Door Thickness Inches	Dimensions Case Inches	Dimensions Escutcheon Inches	Dealer Pkg. 5 Sets 1 Set per Card	OEM Bulk Pkg. 10 Sets	Screw Size	Weight Pounds
1 to 1-3/8	2-3/4 x 2	4-3/8 x 1-1/4	927 DP CHR	927 000 CHR	6	1-1/4

Spare Flush Strike, Cat. No. 913 DP CHR.

Spare Bevel with Cam, Cat. No. 920 DP CHR.

Spare Knob and Handle Assy, Cat. No. 962 000 CHR.

Spare Escutcheon Plate with Keys, Cat. No. 927 000 99B.

**FIG. 960 - MORTISE LATCH SET**

**CONSTRUCTION:**

\* **CHROME PLATED ZINC ALLOY**

\* **TURN BUTTON LOCK**

Bevel can be Reversed During Installation



**FIG. 960**  
SHOWN  
ASSEMBLED



**FIG. 960**

**ORDERING INFORMATION**

For Door Thickness Inches	Dimensions Case Inches	Dimensions Escutcheon Inches	Dealer Pkg. 5 Sets 1 Set per Card	OEM Bulk Pkg. 10 Sets	Screw Size	Weight Pounds
1 to 1-3/8	2-1/4 x 1-13/16	4-3/8 x 1-1/4	960 DP CHR	960 000 CHR	6	1

Spare Flush Strike, Cat. No. 912 DP CHR.

Spare Bevel with Cam, Cat. No. 960 000 99A.

Spare Knob and Handle Assembly, Cat. No. 962 000 CHR.

**FIG. 567 - TUBULAR LATCH SET**

**CONSTRUCTION:**

\* **CHROME PLATED ZINC ALLOY.**

\* **SLIDING LOCK BUTTON.**



**FIG. 567**

**ORDERING INFORMATION**

For Door Thickness Inches	Dimensions Escutcheon Inches	O.D. Tube Inches	Dealer Pkg. 5 Cards 1 Set per Card	OEM Bulk Pkg. 10 Sets	Screw Size	Weight Pounds
1 to 1-3/8	4-3/8 x 1-1/4	3/4	567 DP CHR	567 000 CHR	6	3/4

Spare Flush Strike, Cat. No. 912 DP CHR.

Spare Knob and Handle Assembly, Cat. No. 962 000 CHR.

## CUPBOARD BOLT, CATCH, TURN & LATCH

**FIG. 1101 - CUPBOARD BOLT**

**CONSTRUCTION:**

- \* CHROME PLATED ZINC ALLOY
- \* BLACK PLASTIC SLIDE AND KNOB



**ORDERING INFORMATION**

Dimensions	Dealer Pkg.	OEM	Screw	Weight
Overall	5 Cards	Bulk Pkg.	Size	Ounces
Inches	1 Pc. per Card	50 Pcs.	6	2
2-1/8 x 1-1/2	1101 DP CHR	1101 000 CHR		

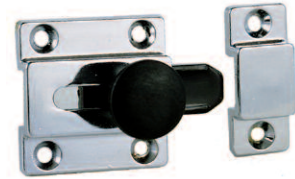

**FIG. 1101**

**FIG. 1102 - CUPBOARD CATCH**

**CONSTRUCTION:**

- \* CHROME PLATED ZINC ALLOY

**No. 1 SUPPLIED WITH BOX STRIKE**

**No. 2 SUPPLIED WITH 3/8 INCH OFFSET BOX STRIKE**



**ORDERING INFORMATION**

Strike	Dimensions	Dealer Pkg.	OEM	Screw	Weight
Type	Overall	5 Cards	Bulk Pkg.	Size	Ounces
	Inches	1 Pc. per Card	50 Pcs.	6	3-1/2
Box	1-1/2 x 1-7/8	1102 DP1 CHR	1102 001 CHR	6	3-1/2
Offset Box	1-1/2 x 1-7/8	1102 DP2 CHR	1102 002 CHR	6	3-1/2

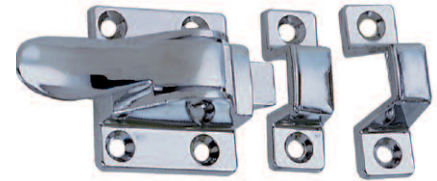

**FIG. 1102**

**FIG. 978 - CUPBOARD TURN**

**CONSTRUCTION:**

- \* CHROME PLATED ZINC ALLOY



**ORDERING INFORMATION**

Dimensions	Dealer Pkg. - 5 Cards	Screw	Weight
Overall	1 Pc. per Card	Size	Ounces
Inches		6	5
2-1/8 x 2-1/4	978 DP CHR		

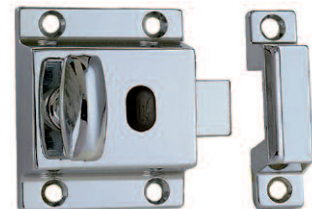

**FIG. 978**

Spare Strike Plate, Cat. No. 976 000 CHR. Spare Bevel with Cam, Cat. No. 984 000 CHR.

**FIG. 948 - LATCH**

**CONSTRUCTION:**

- \* CHROME PLATED ZINC ALLOY
- \* SLIDING LOCK BUTTON



**ORDERING INFORMATION**

Dimensions	Dealer Pkg. - 5 Cards	Screw	Weight
Overall	1 Pc. per Card	Size	Ounces
Inches		6	5
2-1/8 x 2-1/4	948 DP CHR		

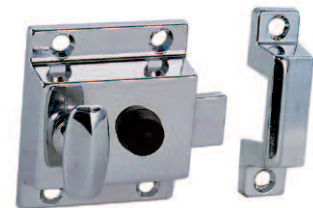

**FIG. 948**

Spare Strike Plate, Cat. No. 976 000 CHR.  
Spare Bevel with Cam, Cat. No. 984 000 CHR.

## LATCH ASSEMBLY & ELBOW CATCHES

**FIG. 938 - PULL AND LATCH ASSEMBLY**



**Fig. 938**

**CONSTRUCTION:**

- \* **CHROME PLATED ZINC ALLOY**
- \* **BLACK PLASTIC INSERT**
- \* **BRASS STEM**



**ORDERING INFORMATION**

O.D. Knob Inches	Max. Panel Thickness Inches	Dealer Pkg. - 5 Cards 1 Pc. per Card	OEM Bulk Pkg. 50 Pcs.	Weight Ounces
1-1/2	1-1/8	938 DP CHR	938 000 CHR	2

Spare Cam Bar, Cat. No. 938 000 99A.

**FIG. 1056 - ELBOW CATCH**



**Fig. 1056**

**CONSTRUCTION:**

- \* **CHROME PLATED ZINC ALLOY**
- \* **STAINLESS STEEL SPRING**



**ORDERING INFORMATION**

Dimensions Inches	Dealer Pkg. - 10 Cards 1 Pc. per Card	OEM Bulk Pkg. 50 Pcs.	Screw Size	Weight Ounces
1-1/8 x 9/16	1056 DP CHR	1056 000 CHR	6	3/4

**FIG. 1021 - ELBOW CATCH**



**Fig. 1021**

**CONSTRUCTION:**

- \* **BLACK PLASTIC**
- \* **INTEGRAL SPRING**



**ORDERING INFORMATION**

Dimensions Inches	Dealer Pkg. - 25 Cards 2 Pcs. per Card	OEM Bulk Pkg. 100 Pcs.	Screw Size	Weight Ounces
1-3/16 x 5/8	1021 DP BLK	1021 000 BLK	6	1/2



## KNOB, "T" HANDLE FLUSH PULL & FLUSH RING CATCH

**FIGS. 925 & 926 - KNOB**

**CONSTRUCTION:**

\* **STAINLESS STEEL SCREW**

**FIG. 925**

\* **CHROME PLATED BRASS**

**FIG. 926**

\* **CHROME PLATED ZINC ALLOY**

\* **BLACK PLASTIC INSERT**



**Fig. 925**



**Fig. 926**



**ORDERING INFORMATION**

O.D. Knob Inches	Max. Panel Thickness Inches	Dealer Pkg. - 10 Cards 1 Pc. per Card	OEM Bulk Pkg. 50 Pcs.	Weight Ounces
1	1-1/8	925 DP CHR	925 000 CHR	1-1/2
1-1/8	1-1/8	926 DP0 CHR	926 000 CHR	3/4
1-1/2	1-1/8	926 DP1 CHR	926 001 CHR	1

**FIG. 1093 - "T" HANDLE FLUSH PULL**

**FOR SMOOTH AND CARPETED SURFACES**

**(GASKET INCLUDED FOR SMOOTH SURFACE APPLICATIONS)**

**(TOOTHED BACK FOR CARPET SURFACE APPLICATIONS)**

**NEW PRODUCT**

**CONSTRUCTION OPTIONS:**

\* **BLACK OR WHITE PLASTIC BODY**

\* **CHROME PLATED ZINC ALLOY, BLACK OR WHITE PLASTIC "T" HANDLE**

\* **STAINLESS STEEL STEM**

Easily Installs in a 2-1/2 Inch Diameter Hole  
For Mounting Surfaces 1/8 to 3/4 Inches Thick



**ORDERING INFORMATION**

Color Body	Color Handle	Diameter Inches	OEM Bulk Pkg. 25 Pcs.	Weight Ounces
Black	Black Plastic	3	1093 000 BLK	8
Black	Chrome Plated	3	1093 000 CHR	8
White	White Plastic	3	1093 000 WHT	8



**Fig. 1093**

**SEE PAGE 168 FOR MATCHING LOCK & LATCH SETS**

**FIG. 1051 - FLUSH RING CATCH**

**CONSTRUCTION:**

\* **CHROME PLATED ZINC ALLOY**

\* **PHOSPHOR BRONZE SPRING**



**Fig. 1051**



**ORDERING INFORMATION**

Dimensions Inches	Dealer Pkg. - 10 Cards 1 Pc. per Card	OEM Bulk Pkg. 25 Pcs.	Screw Size	Weight Ounces
2-1/4 x 1-3/8	1051 DP CHR	1051 000 CHR	6	1-1/2

## FLUSH PULLS



**Fig. 841**

**FIG. 841 - FLUSH RING PULL**

**CONSTRUCTION:**

\* **CHROME PLATED ZINC ALLOY**



**ORDERING INFORMATION**

Dimensions Face Plate Inches	Dealer Pkg. - 10 Cards 1 Pc. per Card	OEM Bulk Pkg. 50 Pcs.	Screw Size	Weight Ounces
1-3/4 x 1-3/8	841 DP CHR	841 000 CHR	6	1



**Fig. 1232**

**FIG. 1232 - FLUSH RING PULL**

**CONSTRUCTION:**

\* **CHROME PLATED ZINC ALLOY**



**ORDERING INFORMATION**

O.D. Face Plate Inches	Dealer Pkg. - 5 Cards 1 Pc. per Card	OEM Bulk Pkg. 50 Pcs.	Screw Size	Weight Ounces
1-5/8	1232 DP1 CHR	1232 001 CHR	6	1
2	1232 DP2 CHR	1232 002 CHR	6	1-1/2



**Fig. 1103**

**FIG. 1103 - FLUSH RING PULL**

**CONSTRUCTION:**

\* **CHROME PLATED BRONZE**



**ORDERING INFORMATION**

Dimensions Face Plate Inches	Dealer Pkg. - 10 Cards 1 Pc. per Card	OEM Bulk Pkg. 50 Pcs.	Screw Size	Weight Ounces
2-9/16 x 2	1103 DP CHR	1103 000 CHR	8	3-1/2



**Fig. 575**

**FIG. 575 - FLUSH LIFTING PULL**

**CONSTRUCTION:**

\* **CHROME PLATED BRONZE**



**ORDERING INFORMATION**

Dimensions Face Plate Inches	Dealer Pkg. - 10 Cards 1 Pc. per Card	OEM Bulk Pkg. 50 Pcs.	Screw Size	Weight Ounces
2-5/8 x 2	575 DP CHR	575 000 CHR	8	3

## PULLS & LIFTING HANDLE

### FIG. 1221 - FLUSH PULL

#### CONSTRUCTION:

- \* CHROME PLATED ZINC ALLOY
  - \* BLACK PLASTIC FINISHING FLANGE
- Spring Loaded, Can be Mounted Horizontally or Vertically



#### ORDERING INFORMATION

Dimensions	Dealer Pkg. - 5 Cards	OEM Bulk Pkg.	Screw Size	Weight Ounces
Flange Inches	1 Pc. per Card	50 Pcs.	8	3
3/4 x 3-1/4	1221 DP CHR	1221 000 CHR		



Fig. 1221

### FIGS. 1286 & 1288 - RING PULLS

#### CONSTRUCTION:

- \* CHROME PLATED ZINC ALLOY

FIG. 1286 - FOR SURFACE MOUNTING WITH BLACK PLASTIC SPACER

FIG. 1288 - FOR FLUSH MOUNTING, EASILY INSTALLS IN A 2 INCH DIAMETER HOLE



#### ORDERING INFORMATION

Type of Mounting	O.D. Cup Inches	Dealer Pkg. - 5 Cards	Screw Size	Weight Ounces
Surface	2-1/4	1286 DP CHR	8	3-1/2
Flush	2-1/4	1288 DP CHR	8	3-1/2



Fig. 1286

### FIG. 776 - FLUSH LIFTING HANDLE

#### CONSTRUCTION:

- \* CHROME PLATED BRONZE

Size No. 2 (Not Shown) Has All Mounting Holes at Corners



#### ORDERING INFORMATION

Dimensions Face Plate Inches	Dimensions Inside Handle Inches	Dealer Pkg. 5 Cards 1 Pc. per Card	OEM Bulk Pkg. 25 Pcs.	Screw Size	Weight Ounces
3 x 2-1/4	1-7/8 x 1	776 DP1 CHR	776 001 CHR	8	3-1/2
3-3/4 x 2-3/4	2-3/16 x 1-3/16	776 DP2 CHR	776 002 CHR	8	5-1/2



Fig. 776

### FIG. 1220 - FLUSH LIFTING HANDLE

#### CONSTRUCTION:

- \* CHROME PLATED ZINC ALLOY



#### ORDERING INFORMATION

Dimensions Face Plate Inches	Dimensions Inside Handle Inches	Dealer Pkg. 5 Cards 1 Pc. per Card	OEM Bulk Pkg. 50 Pcs.	Screw Size	Weight Ounces
3 x 2-1/4	1-7/8 x 1	1220 DP CHR	1220 000 CHR	8	3



Fig. 1220

## FLUSH PULLS & SLIDING WINDOW HANDLE

**FIG. 1110 - FLUSH PULL**



**Fig. 1110**

**CONSTRUCTION:**

\* **CHROME PLATED ZINC ALLOY**



**ORDERING INFORMATION**

Dimensions	Depth	Dealer Pkg.	OEM	Screw	Weight
Face Plate	Inches	5 Cards	Bulk Pkg.	Size	Ounces
Inches	Inches	1 Pc. per Card	50 Pcs.		
3-11/16 x 1-11/16	7/16	1110 DP CHR	1110 000 CHR	6	3

**FIG. 1016 WHITE**

**FIG. 1016 - FLUSH PULL**

**FIG. 1016 BLACK**



**CONSTRUCTION OPTIONS:**

\* **BLACK OR WHITE PLASTIC**

Easily Installs in a 1-3/4 Inch Diameter Hole



**ORDERING INFORMATION**

Color	Dimensions	Depth	Dealer Pkg.	OEM	Screw	Weight
	Face Plate	Inches	10 Cards	Bulk Pkg.	Size	Ounces
	Inches	Inches	1 Pc. per Card	100 Pcs.		
Black	2-1/4 x 2-1/4	15/16	1016 DP BLK	1016 000 BLK	6	1
White	2-1/4 x 2-1/4	15/16	1016 DP WHT	1016 000 WHT	6	1



**FIGS. 958 - PULL**



**Fig. 958**

**CONSTRUCTION:**

\* **CHROME PLATED ZINC ALLOY**



**ORDERING INFORMATION**

Width	Width	Dealer Pkg. - 10 Cards	Screw	Weight
Overall	Inside	1 Pc. per Card	Size	Ounces
Inches	Inches			
3-7/16	2-5/16	958 DP CHR	6	1

**FIG. 954 - SLIDING WINDOW HANDLE**



**Fig. 954**

**CONSTRUCTION:**

\* **STAINLESS STEEL**



**ORDERING INFORMATION**

For Glass	Length	Dealer Pkg. - 5 Cards	Weight
Thickness	Overall	1 Pc. per Card	Ounces
Inches	Inches		
1/4	3	954 DP STS	1



## WINDOW STOPS, LOCKS & FASTENERS

### FIG. 935 & 966 - SLIDING WINDOW & DOOR STOPS

**CONSTRUCTION:**

- \* **PLASTIC COVER ON STOPPING PLATE**

**FIG. 935 - FOR SLIDING WINDOWS**  
**CHROME PLATED ZINC ALLOY**

**FIG. 966 - FOR SLIDING DOORS**  
**CHROME PLATED HEAVY GAUGE EXTRUDED BRASS**



**ORDERING INFORMATION**

Dimensions Mounting Plate Inches	Length Stopping Plate Inches	Dealer Pkg. 5 Cards 1 Pc. per Card	OEM Bulk Pkg. 50 Pcs.	Screw Size	Weight Ounces
1-7/8 x 3/4	1-1/2	935 DP CHR	935 000 CHR	8	2
1-1/2 x 3/4	2	966 DP CHR	966 000 CHR	10	2

**NEW PRODUCT**



**FIG. 935**

**FIG. 966**

### FIGS. 934 & 937- SLIDING WINDOW LOCK & ANTI-RATTLER

**CONSTRUCTION:**

- \* **CHROME PLATED ZINC ALLOY**
- \* **BLACK PLASTIC KNOB AND TIP**



**ORDERING INFORMATION**

Height Overall Inches	Dimensions Mounting Plate Inches	Adjustment Inches	Dealer Pkg. 5 Cards 1 Pc. per Card	Screw Size	Weight Ounces
1	2 x 5/8	1-1/8	934 DP CHR	6	1-1/4
1-5/8	1 x 5/8	1-1/8	937 DP CHR	6	1-1/4

Spare Black Plastic Tip, Cat. No. 944



**FIG. 934**

**FIG. 937**

### FIG. 719 - FASTENER

**CONSTRUCTION:**

- \* **CHROME PLATED BRASS**
- \* **BLACK PLASTIC KNOB WITH STAINLESS STEEL STUD**



**ORDERING INFORMATION**

Length Angle Inches	Width Angle Inches	Dealer Pkg. 5 Cards 1 Pc. per Card	OEM Bulk Pkg. 25 Pcs.	Screw Size	Weight Ounces
1-3/8	1	719 DP CHR	719 000 CHR	8	3

Spare Knob, Cat. No. 719 000 99A

Spare Single Bracket, Cat. No. 719 000 99B

Spare Flat Plate, Cat. No. 719 000 99C



**FIG. 719**

## TABLE BRACKETS & UTILITY HOOKS



**FIG. 148**

**FIG. 148 - TABLE BRACKETS**

**CONSTRUCTION:**

- \* **CHROME PLATED BRASS**  
For Removable Tables

Supplied in Sets Consisting of Two Brackets and Two Wall Plates



**ORDERING INFORMATION**

Dimensions Angle Bracket Inches	Dimensions Wall Plate Inches	Dealer Pkg. 5 Cards 1 Set per Card	OEM Bulk Pkg. 25 Sets	Screw Size	Weight per Set Ounces
2-3/4 x 1-11/16	3-3/8 x 2	148 DP CHR	148 000 CHR	10	12

Spare Pair of Angle Brackets, Cat. No. 148 000 99A.  
Spare Pair of Wall Plates, Cat. No. 148 000 99B.

**FIG. 1106 - UTILITY HOOK**



**FIG. 1106**

**CONSTRUCTION:**

- \* **CHROME PLATED ZINC ALLOY**



**ORDERING INFORMATION**

Projection Inches	Width Base Inches	Dealer Pkg. 10 Cards 1 Pc. per Card	OEM Bulk Pkg. 50 Pcs.	Screw Size	Weight Ounces
3/4	1	1106 DP CHR	1106 000 CHR	6	3/4

**FIG. 975 - UTILITY HOOK**



**FIG. 975**

**CONSTRUCTION:**

- \* **CHROME PLATED ZINC ALLOY**



**ORDERING INFORMATION**

Projection Inches	Width Base Inches	Dealer Pkg. 10 Cards 1 Pc. per Card	OEM Bulk Pkg. 50 Pcs.	Screw Size	Weight Ounces
2	1-1/8	975 DP1 CHR	975 001 CHR	6	1
3	1-1/4	975 DP2 CHR	975 002 CHR	6	1-1/2

**FIG. 610 - UTILITY HOOK**



**FIG. 610**

**CONSTRUCTION:**

- \* **CHROME PLATED ZINC ALLOY**



**ORDERING INFORMATION**

Projection Inches	Width Base Inches	Dealer Pkg. 10 Cards 1 Pc. per Card	OEM Bulk Pkg. 50 Pcs.	Screw Size	Weight Ounces
1-3/8	1-1/8	610 DP CHR	610 000 CHR	6	1/2

## FASTENERS

### **Figs. 869, 896, 898, 901 & 907 - "DURABLE TYPE" FASTENERS**

#### **CONSTRUCTION:**

**Figs. 896, 898, 901 & 907 - NICKEL PLATED BRASS**  
**FIG. 869 - STAINLESS STEEL, 5/8 INCH SELF TAPPING SCREW**

For Canvas to Surface, Use Figs. 869, 896 and 898  
 For Canvas to Canvas, Use Figs. 896, 898, 901 & 907

#### **ORDERING INFORMATION**

Description	Std. Pkg. - 100 Pcs. OEM Pkg. - 500 Pcs.
Stud	869 000 STS
Stud	901 000 NKL
Socket	898 000 NKL
Button	896 000 NKL
Eyelet	907 000 NKL



**SOCKET**  
**FIG. 898**

**STUD**  
**FIG. 901**

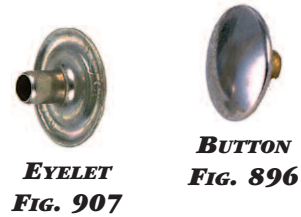

**EYELET**  
**FIG. 907**

**BUTTON**  
**FIG. 896**



**STUD**  
**FIG. 869**



### **Figs. 60, 62, 116, 117 & 118 - "LIFT TYPE" FASTENERS**

#### **CONSTRUCTION:**

**Figs. 60, 62, 116 & 118 - NICKEL PLATED BRASS**  
**FIG. 117 - STAINLESS STEEL, 1/2 INCH SELF TAPPING SCREW**

#### **ORDERING INFORMATION**

Description	Standard Pkg. - 100 Pcs.
Clinch Stud	60 000 NKL
Clinch Washer	62 000 NKL
Clinch Plate	118 000 NKL
Stud	*117 000 STS
Socket	116 000 NKL

\*OEM Pkg. - 500 pcs.



**CLINCH STUD**  
**FIG. 60**

**CLINCH WASHER**  
**FIG. 62**



**STUD**  
**FIG. 117**

**SOCKET**  
**FIG. 116**

**CLINCH PLATE**  
**FIG. 118**



### **Figs. 994, 996 & 997 - CURTAIN FASTENERS**

#### **CONSTRUCTION:**

**\* NICKEL PLATED BRASS**

#### **ORDERING INFORMATION**

Description	Standard Pkg. - 100 Pcs.
Flanged Stud	994 000 NKL
Eyelet	996 000 NKL
Washer	997 000 NKL

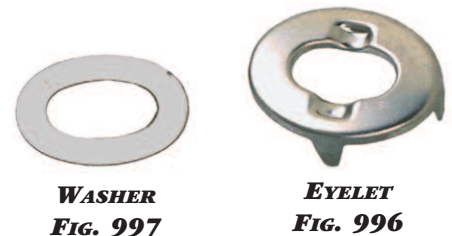

**WASHER**  
**FIG. 997**

**EYELET**  
**FIG. 996**



**FLANGED STUD**  
**FIG. 994**



## CONVERTIBLE TOP FITTINGS, UTILITY HOOK & BOAT COVER SOCKETS



**SOCKET**  
Fig. 395#3



**SLIDE**  
Figs. 395#6 & 395 #8



**SIDE PLATE**  
Fig. 395#8



**HINGE**  
Fig. 395#1 & 395 #H



**EYE END**  
Figs. 395#5 & 395#9

### FIG. 395 - CONVERTIBLE TOP FITTINGS

- CONSTRUCTION:**
- \* CHROME PLATED ZINC ALLOY
  - \* STAINLESS STEEL SCREWS



#### ORDERING INFORMATION

Description	Dealer Pkg. - 5 Cards 2 Pcs. per Card	OEM Bulk Pkg. 100 Pcs.	Screw Size	Average Weight Ounces
Hinge for 3/4" fittings	395 DP1 CHR	395 001 CHR	8	2
Socket for 3/4" tubing	395 DP3 CHR	395 003 CHR	---	2
Eye End for 3/4" tubing with .049" wall	395 DP5 CHR	*395 005 CHR	---	2
Slide for 3/4" tubing	395 DP6 CHR	395 006 CHR	---	2
Side Mounting Plate	395 DP8 CHR	395 008 CHR	10	2
Eye End for 7/8" tubing	395 DP9 CHR	395 009 CHR	---	2
Slide for 7/8" tubing	395 DPS CHR	**395 010 CHR	---	2
Hinge for 7/8" fittings	395 DPH CHR	**395 011 CHR	8	2



\*OEM Bulk Pkg. - 200 pcs.  
\*\*OEM Bulk Pkg. - 50 pcs.

### FIG. 1249 - UTILITY HOOK



Fig. 1249



- CONSTRUCTION:**
- \* CHROME PLATED ZINC ALLOY



#### ORDERING INFORMATION

Length Overall Inches	Width Overall Inches	Inside Hook Inches	Dealer Pkg. 10 Cards 5 Pcs. per Card	OEM Bulk Pkg. 100 Pcs.	Screw Size	Weight Ounces
15/16	1/2	1/4	1249 DP CHR	1249 000 CHR	6	1/2

### FIG. 578 - BOAT COVER SOCKETS



Fig. 578



- CONSTRUCTION:**
- \* CHROME PLATED ZINC ALLOY
- Will Accommodate 3/8 Inch Wood or  
Plastic Battens Up To 1-3/4 Inches Wide



#### ORDERING INFORMATION

Length Overall Inches	Dimensions Opening Inches	Width Overall Inches	Dealer Pkg. - 10 Cards 1 Pair per Card	Screw Size	Weight per Pair Ounces
3-1/4	1-7/8 x 7/16	5/8	578 DP CHR	6	1/2

## OUTRIGGER POLE HOLDERS

**FIG. 445 - OUTRIGGER POLE HOLDERS**

**CONSTRUCTION:**

- \* **STAINLESS STEEL MAIN TUBE**
- \* **CHROME PLATED BRASS YOKE TUBING AND BRONZE FITTINGS**

A large knob on the sliding clamp provides ready adjustment for all fishing positions. A stainless steel drift pin in the sliding clamp is pulled to release the pole holder to a down and aft position. Features include heavy bi-directional hinged mounting base for easy installation on a horizontal or vertical surface. A stop collar (Fig. No. 415) is included for presetting the desired fishing angle. Sturdy folding lay down hooks (Fig. No. 410) are also included for supporting the outriggers in the down position. The mounting yokes may be installed in an inverted position, rather than that shown, to accommodate various installation requirements.



**ORDERING INFORMATION**

Holder Size No.	I.D. Main Tube Inches	"A" Length Main Tube Inches	O.D. Main Tube Inches	Standard Pkg. - 1 Pair	"B" Yoke Width Inches	Weight Per Pair Pounds	Bolt Size Inches
1	1.500	20	1-5/8	445 001 CHR	11-3/4	22	1/4
2	1.900	20	2	445 002 CHR	11-3/4	24	1/4
3	1.900	35	2	445 003 CHR	24	33	1/4

Size No. 1 For Use With Outrigger Poles Cat. Nos. 1798 016 ALU and 1798 018 ALU.

Size No. 2 For Use With Outrigger Poles Cat. No. 1798 019 ALU.

Size No. 3 For Use With Outrigger Poles Cat. Nos. 1798 019 ALU, 1798 022 ALU and 1798 025 ALU.

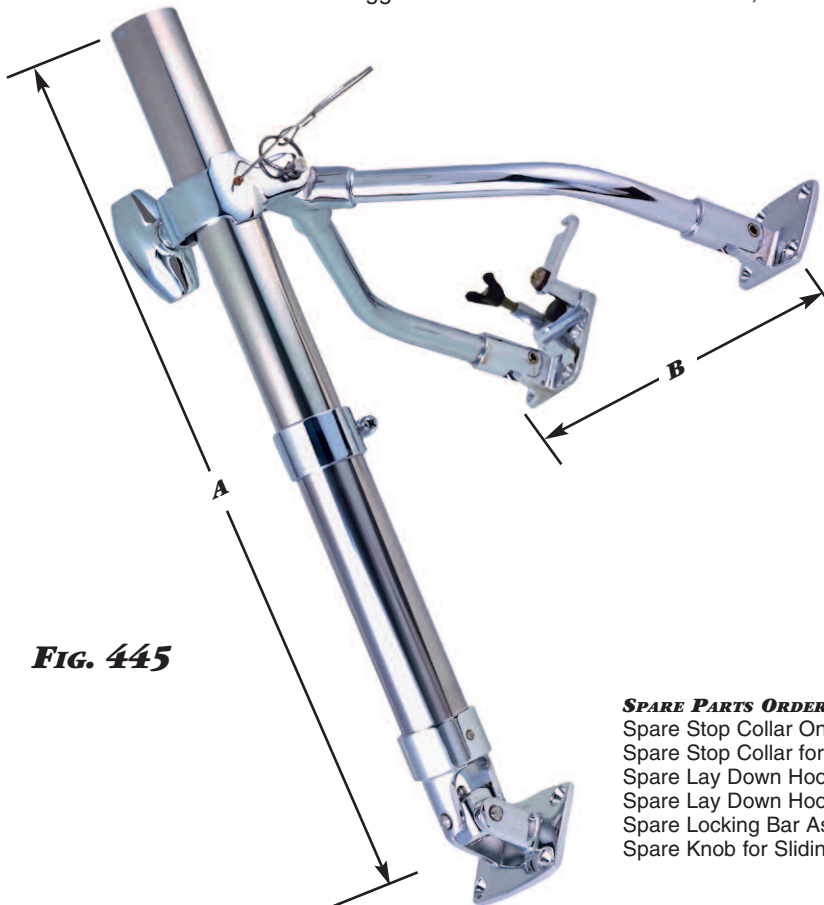

**FIG. 445**

Sizes 1 and 2 feature a retaining bar on one mounting bracket (as illustrated) to hold the outrigger in the vertical position.

Size 3 features a standard hinge holding bracket (Fig. No. 408) for quick release of the main tube.



**FIG. 408**



**FIG. 410**



**FIG. 415**

**SPARE PARTS ORDERING INFORMATION**

- Spare Stop Collar Only for Size 1 Holder, Cat. No. 415 001 CHR.
- Spare Stop Collar for Size 2 and 3 Holders, Cat. No. 415 002 CHR.
- Spare Lay Down Hook for Size 1 Holder, Cat. No. 410 001 CHR.
- Spare Lay Down Hook for Size 2 and 3 Holders, Cat. No. 410 002 CHR.
- Spare Locking Bar Assembly with Stud, Cat. No. 406 000 99A.
- Spare Knob for Sliding Clamp Assembly, Cat. No. 401 000 CHR.

## OUTRIGGER POLE HOLDERS

**FIG. 470 - OUTRIGGER POLE HOLDERS**

**CONSTRUCTION:**

- \* **STAINLESS STEEL MAIN TUBE**
- \* **CHROME PLATED BRASS YOKE TUBING AND BRONZE FITTINGS**

A large knob on the sliding clamp provides ready adjustment for all fishing positions. A stainless steel drift pin in the sliding clamp is pulled to release the pole holder to a down and aft position. Features include a heavy swivel mounting base for easy installation on a horizontal or vertical surface. A stop collar (Fig. No. 415) is included for presetting the desired fishing angle. Sturdy folding lay down hooks (Fig. No. 410) are also included for supporting the outriggers in the down position. The mounting yokes may be installed in an inverted position, rather than that shown, to accommodate various installation requirements.



**ORDERING INFORMATION**

Holder Size No.	I.D. Main Tube Inches	"A" Length Main Tube Inches	O.D. Main Tube Inches	Standard Pkg. - 1 Pair	"B" Yoke Width Inches	Weight Per Pair Pounds	Bolt Size Inches
1	1.500	20	1-5/8	470 001 CHR	11-3/4	22	1/4
2	1.900	20	2	470 002 CHR	11-3/4	24	1/4
3	1.900	35	2	470 003 CHR	24	33	1/4

Size No. 1 For Use With Outrigger Poles Cat. Nos. 1798 016 ALU and 1798 018 ALU.

Size No. 2 For Use With Outrigger Poles Cat. Nos. 1798 019 ALU.

Size No. 3 For Use With Outrigger Poles Cat. Nos. 1798 019 ALU, 1798 022 ALU and 1798 025 ALU.

Sizes 1 and 2 feature a retaining bar on one mounting bracket (as illustrated) to hold the outrigger in the vertical position.

Size 3 features a standard hinge holding bracket (Fig. No. 408) for quick release of the main tube.



**SPARE PARTS ORDERING INFORMATION**

- Spare Stop Collar Only for Size 1 Holder, Cat. No. 415 001 CHR.
- Spare Stop Collar for Size 2 and 3 Holders, Cat. No. 415 002 CHR.
- Spare Lay Down Hook for Size 1 Holder, Cat. No. 410 001 CHR.
- Spare Lay Down Hook for Size 2 and 3 Holders, Cat. No. 410 002 CHR.
- Spare Locking Bar Assembly with Stud, Cat. No. 406 000 99A.
- Spare Knob for Sliding Clamp Assembly, Cat. No. 401 000 CHR.

## OUTRIGGER POLE HOLDERS

**REMOVABLE TUBES LIFT AND TURN TO THREE POSITIONS: VERTICAL, FISHING AND LOWERED.  
UNIVERSAL TUBES MAY BE USED ON EITHER SIDE.  
SUPPLIED IN PAIRS CONSISTING OF TWO MOUNTS AND TWO TUBES.**

**FIG. 444 - SIDE MOUNT OUTRIGGER POLE HOLDERS**

**CONSTRUCTION:**

- \* CHROME PLATED BRONZE BRACKETS
- \* SIZE 1 TUBES ARE POLISHED STAINLESS STEEL
- \* SIZE 2 TUBES ARE CHROME PLATED BRASS



**ORDERING INFORMATION**

Holder Size No.	I.D. Tube Inches	O.D. Tube Inches	Dimensions Bracket Inches	Dealer Pkg. - 5 Pkgs. 1 Pair per Pkg.	Standard Pkg. - 1 Pair	Weight per Pair Pounds
1	1.120	1-1/4	4-1/2 x 3	444 DP1 CHR	-----	4-5/8
2	1.500	1-5/8	6-1/2 x 4	-----	444 002 CHR	8-1/4

Size 1 Bolt Size - 1/4".      Size 2 Bolt Size - 5/16".  
Spare Bracket For Size No. 1, Cat. No. 478 001 CHR.  
Spare Bracket For Size No. 2, Cat. No. 478 002 CHR.  
See Fig. 451 for Outrigger Designations and Spare Tube Ordering.



**FIG. 444**

**FIG. 451 - DECK MOUNT OUTRIGGER POLE HOLDERS**

**CONSTRUCTION:**

- \* CHROME PLATED BRONZE PLATES
- \* SIZE 1 TUBES ARE POLISHED STAINLESS STEEL
- \* SIZE 2 TUBES ARE CHROME PLATED BRASS



**ORDERING INFORMATION**

Holder Size No.	I.D. Tube Inches	O.D. Tube Inches	Dimensions Bracket Inches	Dealer Pkg. - 5 Pkgs. 1 Pair per Pkg.	Standard Pkg. - 1 Pair	Weight per Pair Pounds
1	1.120	1-1/4	5 x 2-1/2	451 DP1 CHR	-----	6-5/8
2	1.500	1-5/8	6 x 3-1/2	-----	451 002 CHR	11-1/4

Size 1 Bolt Size - 1/4".      Size 2 Bolt Size - 5/16".  
Spare Tube Only For Figs. 444 & 451 Size 1, Cat. No. 479 DP1 STS.      Spare Plate Only for Size No. 1, Cat. No. 474 001 CHR.  
Spare Tube Only For Figs. 444 & 451 Size 2, Cat. No. 479 002 CHR.      Spare Plate Only for Size No. 2, Cat. No. 474 002 CHR.  
Size No. 1 For Use With Outrigger Poles Cat. Nos. 476 015 ALU and 1798 015 ALU.  
Size No. 2 For Use With Outrigger Poles Cat. Nos. 1798 016 ALU and 1798 018 ALU.



**FIG. 451**

**FIG. 1314 - DECK MOUNT OUTRIGGER POLE HOLDERS**

**CONSTRUCTION:**

- \* CHROME PLATED ZINC ALLOY PLATES
- \* STAINLESS STEEL TUBES

**IMPROVED FOR USE WITH ALUMINUM OUTRIGGER POLES,  
CAT. NOS. 1798 015 ALU AND 476 015 ALU**



**ORDERING INFORMATION**

I.D. Tube Inches	O.D. Tube Inches	Dimensions Bracket Inches	Dealer Pkg. 5 Pkgs. 1 Pair per Pkg.	OEM Bulk Pkg. 10 Pair	Bolt Size Inches	Weight per Pair Pounds
1.120	1-1/4	5 x 2-1/2	1314 DP CHR	1314 000 CHR	1/4	4-3/4

Spare Tube Only, Cat. No. 479 DP1 STS.      Spare Plate Only, Cat. No. 1320 000 CHR.



**FIG. 1314**

## OUTRIGGER POLES & SPREADERS

**FIG. 1798 - OUTRIGGER POLES**

**CONSTRUCTION:**

**\* SILVER ANODIZED ALUMINUM  
WITH BLACK PLASTIC INSULATED BASE**

Sizes 15 Through 19 Have Standard (Fig. No. 468) Line Guides,  
and All Sizes Have Roller Tip (Fig. No. 471) Line Guides

Heavy Duty Poles For Rough Water Use.

Sizes 15 Through 19 Have Sections Threaded For Easy Assembly

**ORDERING INFORMATION**

"A" Length Overall Feet	"B" Base Diameter Inches	Number Of Sections	Silver Standard Pkg. - 1 Pair Cat. No.	Silver Single Pole Only Cat. No.	Weight per Pair Pounds
15	1.120	4	1798 015 ALU	1798 015 99A	6-1/2
15	1.500	4	1798 016 ALU	1798 016 99A	8-1/4
18-2/3	1.500	5	1798 018 ALU	1798 018 99A	12-5/8
18-2/3	1.900	5	1798 019 ALU	1798 019 99A	12-3/4

**FIG. 1714 - SPREADERS**

**CONSTRUCTION:**

**\* ANODIZED ALUMINUM, SILVER FINISH  
\* SPREADER ARMS AND EYE BANDS**

Designed For Use With Our Aluminum  
Outrigger Poles When Maximum Rigidity is Desired.  
Spreaders Are Suggested For Use On  
18 and 19 Foot Outrigger Poles.

Supplied in Pairs, Consisting of: Spreaders,  
Stainless Steel Cable, Eye Bands and Turnbuckles.

**ORDERING INFORMATION**

For Use With Outrigger Poles Catalog Numbers	Silver Single Spreader Standard Pkg. - 1 Pair
1798 018 ALU	1714 018
1798 019 ALU	1714 018

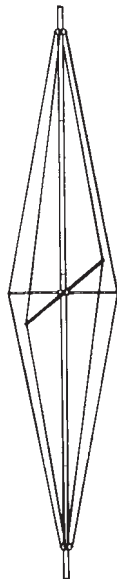
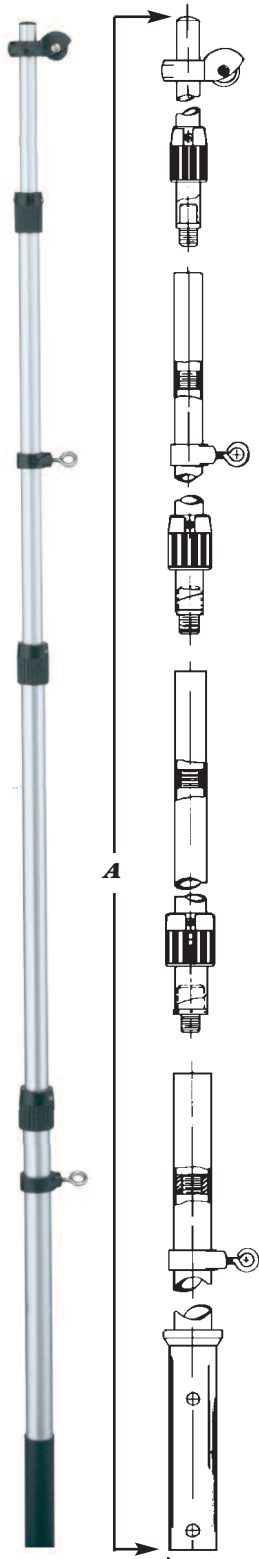

**FIG. 1798**      **FIG. 1714**



## OUTRIGGER POLE KIT, LINE GUIDES & TROLLING PIN

**FIG. 476 - 15' OUTRIGGER POLE KIT**

**CONSTRUCTION:**

\* **ALUMINUM**

One Pair of Fig. No. 1798 015 Aluminum Poles, Guides and Clips Included.

For Use With Fig. Nos. 444 DP1 CHR, 451 DP1 CHR and 1314 DP CHR Holders.

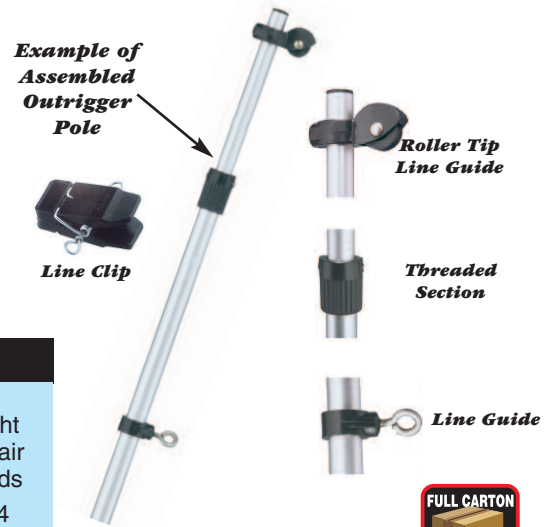

**FIG. 476**



**ORDERING INFORMATION**

Open Length Overall Feet	O.D. Base Inches	Number of Sections	Standard Pkg. 1 Kit per Box	Weight per Pair Pounds
15	1.120	4	476 015 ALU	6-3/4

Spare Pole Only, Cat. No. 1798 015 99A.

**FIG. 471 - OUTRIGGER POLE ROLLER TIP LINE GUIDES**

**CONSTRUCTION:**

\* **HIGH IMPACT BLACK PLASTIC**  
\* **7/8 INCH O.D. NYLON SHEAVE**



**ORDERING INFORMATION**

I.D. Body Inches	For Use With Outrigger Pole Size	Maximum Rope Size Inches	Dealer Pkg. 5 Cards 1 Pair per Card	Weight per Pair Ounces
9/16	-----	1/4	471 DP1 BLK	1
5/8	1798 015	1/4	471 DP2 BLK	1
3/4	1798 016 thru 019	1/4	471 DP3 BLK	1



**FIG. 471**



**FIG. 468 - OUTRIGGER POLE LINE GUIDES**

**CONSTRUCTION:**

\* **HIGH IMPACT BLACK PLASTIC**  
\* **3/8 INCH I.D. STAINLESS STEEL EYE**



**ORDERING INFORMATION**

I.D. Body Inches	Dealer Pkg. - 5 Cards 2 Pcs. per Card	Weight per Pair Ounces
9/16	468 DP1 BLK	3
5/8	468 DP2 BLK	3-1/2
3/4	468 DP3 BLK	3-1/2
1	468 DP4 BLK	3-1/2
1-3/16	468 DP5 BLK	4
1-5/8	468 DP6 BLK	4-1/2



**FIG. 468**



**FIG. 469 - OUTRIGGER TROLLING PIN OR CLIP**

**CONSTRUCTION:**

\* **HIGH IMPACT BLACK PLASTIC**  
\* **STAINLESS STEEL EYES AND SPRING**



**ORDERING INFORMATION**

Dimensions Inches	Dealer Pkg. - 5 Cards 2 Pcs. per Card	Weight Ounces
2-3/4 x 1-3/8	469 DP BLK	1-1/2



**FIG. 469**



## FISHING ROD HOLDERS

### FIGS. 447 - FISHING ROD HOLDERS



Fig. 447

#### VERTICAL FLUSH MOUNT

##### CONSTRUCTION:

- \* CHROME PLATED BRONZE FLANGE
- \* STAINLESS STEEL TUBE
- \* HARD BLACK PLASTIC LINER
- \* INTEGRAL FLIP-UP CAP



#### ORDERING INFORMATION

Mount Type	Drain Bib	I.D. Tube Inches	O.D. Tube Inches	Length Under Flange Inches	Dimensions Flange Inches	Dealer Pkg. 5 Pkgs. 1 Pc. per Pkg.	OEM Bulk Pkg. 10 Pcs.	Bolt Size	Weight Pounds
Vertical	No	1-5/8	2	9	3-1/2 O.D.	447 DP1 CHR	447 001 CHR	10	1-1/4

### FIG. 448 - FISHING ROD HOLDERS

#### ANGLED FLUSH MOUNT (APPROXIMATE 65°)

##### CONSTRUCTION:

- \* CHROME PLATED BRONZE FLANGE
- \* CHROME PLATED BRASS TUBE



Fig. 448-D01  
ILLUSTRATED

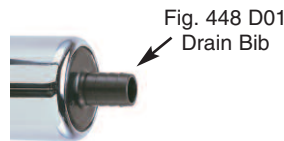

Fig. 448 D01  
Drain Bib

Fig. 448 No. 1 - Soft Black Liner and Flange Gasket with Integral Flip-up Cap.  
D01 - Includes a Drain Bib for 5/8 Inch I.D. Flexible Hose.

001 & DP1 Without Drain Bib.

Fig. 448 No. 2 - Soft Black Liner with Lip Only.



#### ORDERING INFORMATION

Mount Type	Drain Bib	I.D. Tube Inches	O.D. Tube Inches	Length Under Flange Inches	Dimensions Flange Inches	Dealer Pkg. 5 Pkgs. 1 Pc. per Pkg.	OEM Bulk Pkg. 10 Pcs.	Bolt Size	Weight Pounds
Angled	No	1-5/8	2	8	4-1/4 x 3-1/2	448 DP1 CHR	448 001 CHR	1/4	2
Angled	Yes	1-5/8	2	9-1/2	4-1/4 x 3-1/2	-----	448 D01 CHR	1/4	2
Angled	No	1-7/8	2-1/4	12	4-7/8 x 4	*448 DP2 CHR	-----	1/4	3-3/8

\*Dealer Pkg. - 1 card, 1 Pc. per card.

### FIG. 452 - FISHING ROD HOLDER

#### ANGLED FLUSH MOUNT (APPROXIMATE 65°)

##### CONSTRUCTION:

- \* POLISHED STAINLESS STEEL FLANGE
- \* STAINLESS STEEL TUBE.
- \* SOFT BLACK LINER
- \* FLANGE GASKET WITH INTEGRAL FLIP-UP CAP

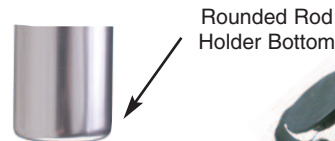

Rounded Rod  
Holder Bottom



Fig. 452

#### ORDERING INFORMATION

I.D. Tube Inches	O.D. Tube Inches	Length Under Flange Inches	Dimensions Flange Inches	Dealer Pkg. - 5 Pkgs. 1 Pc. per Pkg.	OEM Bulk Pkg. 20 Pcs.	Weight Pounds
1-5/8	2	8-1/4	4-1/8 x 3-3/8	452 DP STS	452 000 STS	1-3/8

Bolt Size #10.

#### SPARE PARTS ORDERING INFORMATION

Spare Liner with Lip and Tube, See Fig. 482 DP, Specify Size, Page 198.

Spare Cap and Gasket Kit, See Figs. 480 DP and 481 DP, Page 198.

Spare Cap and Gasket Kit for Fig. 447, Cat No. 484 DP BLK, Page 198..

## FISHING ROD HOLDERS

**FIG. 1205 - FISHING ROD HOLDER**

**ANGLED FLUSH MOUNT (APPROXIMATE 65°)**

**CONSTRUCTION:**

- \* CHROME PLATED ZINC ALLOY FLANGE
- \* ANODIZED ALUMINUM TUBE.
- \* SOFT BLACK LINER AND
- \* FLANGE GASKET WITH INTEGRAL FLIP-UP CAP

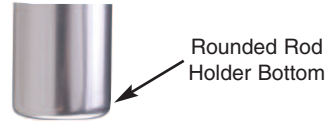

**FIG. 1205**



**ORDERING INFORMATION**

I.D. Tube Inches	O.D. Tube Inches	Length Under Flange Inches	Dimensions Flange Inches	Dealer Pkg. 5 Pkgs. 1 Pc. per Pkg.	OEM Bulk Pkg. 20 Pcs.	Weight Pounds
1-5/8	2	8	4-1/4 x 3-1/2	1205 DP CHR	1205 000 CHR	1-1/2

Bolt Size 1/4".

**FIG. 1099 - FISHING ROD HOLDER**

**SIDE MOUNT**

**CONSTRUCTION:**

- \* STAINLESS STEEL TUBE
- \* CHROME PLATED BRASS BRACKETS
- \* HARD BLACK PLASTIC LINER

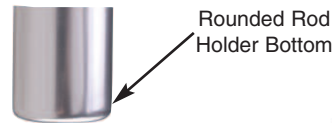

**FIG. 1099**



**ORDERING INFORMATION**

I.D. Tube Inches	O.D. Tube Inches	Length Overall Inches	Width Bracket Inches	Dealer Pkg. 5 Pkgs. 1 Pc. per Pkg.	Weight Pounds
1-5/8	2	9	3	1099 DP STS	1-1/2

Mounting Screw Size #8 R.H.  
Spare Bracket, Cat. No. 1107 000 CHR.

NOTE: The use of a safety line attached to the rod and reel is recommended, particularly when running or fishing with heavy duty rods and reels.

**FIG. 1100 - FISHING ROD HOLDER**

**SIDE MOUNT**

**CONSTRUCTION:**

- \* CHROME PLATED BRASS TUBE & BRACKETS
- \* HARD BLACK PLASTIC LINER

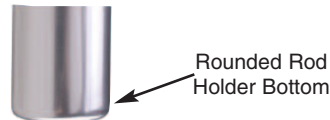

**FIG. 1100**



**ORDERING INFORMATION**

I.D. Tube Inches	O.D. Tube Inches	Length Overall Inches	Width Bracket Inches	Dealer Pkg. 5 Pkgs. 1 Pc. per Pkg.	Weight Pounds
1-5/8	2	9	3	1100 DP CHR	1-1/4

Bolt Size #8 R.H.  
Spare Bracket, Cat. No. 1107 000 CHR.

NOTE: The use of a safety line attached to the rod and reel is recommended, particularly when running or fishing with heavy duty rods and reels.

## FISHING ROD HOLDERS

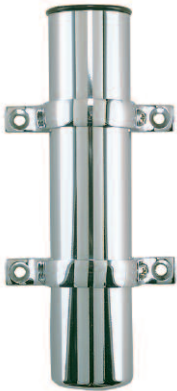

**Fig. 404 #1**



Size #1  
Rounded  
Rod Holder  
Bottom

**SIDE MOUNT**

**CONSTRUCTION:**

**\* CHROME PLATED BRASS AND BRONZE**

**SIZE #1 WITH HARD BLACK PLASTIC LINER**

**SIZE #2 SOFT BLACK LIP & LINER**



**ORDERING INFORMATION**

I.D. Tube Inches	O.D. Tube Inches	Length Overall Inches	Width Bracket Inches	Dealer Pkg. - 5 Pkgs. 1 Pc. per Pkg.	Weight Pounds
1-5/8	2	9	4-3/16	404 DP1 CHR	2
1-7/8	2-1/4	11	4-3/4	*404 DP2 CHR	3-1/8

Bolt Size 1/4".

\* Dealer Pkg. - 1 card, 1 Pc. per card.

Spare Bracket for Size No. 1, Cat. No. 404 001 99A.

Spare Bracket for Size No. 2, Cat. No. 404 002 99A.

Spare Liner with Lip and Tube for Size #2 See Fig. 483 DP2 BLK on Page 198.

NOTE: The use of a safety line attached to the rod and reel is recommended, particularly when running or fishing with heavy duty rods and reels.



**Fig. 404 #2**

### FIG. 1104 - FISHING ROD HOLDER

**SIDE MOUNT**

**CONSTRUCTION:**

**\* BLACK PLASTIC**

**\* CHROME PLATED BRASS BRACKETS**



**ORDERING INFORMATION**

I.D. Tube Inches	O.D. Tube Inches	Length Overall Inches	Width Bracket Inches	Dealer Pkg. - 5 Pkgs. 1 Pc. per Pkg.	Weight Pounds
1-5/8	2	9	3-1/4	1104 DP BLK	5/8

Bolt Size #8 R.H.

Spare Bracket, Cat. No. 1107 000 CHR.

NOTE: The use of a safety line attached to the rod and reel is recommended, particularly when running or fishing with heavy duty rods and reels.



**Fig. 1104**

## FISHING ROD HOLDERS

**FIG. 1118 - FISHING ROD HOLDER**

**CLAMP ON**

**CONSTRUCTION:**

- \* **CHROME PLATED BRASS AND BRONZE**
- \* **HARD BLACK PLASTIC LINER**
  
- \* **CLAMP-ON FEATURE ELIMINATES DRILLING RAIL AND SIMPLIFIES RELOCATION.**
- \* **MOUNTS ON VERTICAL OR HORIZONTAL RAILS**
- \* **ADJUSTABLE FOR RAILS 7/8 TO 1 INCH IN DIAMETER AND BY REDUCING MOUNTING BOLT LENGTH, 3/4 INCH DIAMETER RAILS**



**ORDERING INFORMATION**

I.D. Tube Inches	O.D. Tube Inches	Length Overall Inches	Dealer Pkg. 5 Pcs.	Weight Pounds
1-5/8	2	9	1118 DP CHR	2-1/4

Spare Face Plate with Bolts, Cat. No. 1118 000 99A.  
Spare Intermediate Plate, Cat. No. 1118 000 99B.

NOTE: The use of a safety line attached to the rod and reel is recommended, particularly when running or fishing with heavy duty rods and reels.



**FIG. 1118**



Rounded Rod Holder Bottom

**FIG. 1215 - FISHING ROD HOLDER**

**CLAMP ON**

**CONSTRUCTION:**

- \* **CHROME PLATED ZINC ALLOY**
- \* **POLISHED STAINLESS STEEL TUBE**
- \* **HARD BLACK PLASTIC LINER**
  
- \* **CLAMP-ON FEATURE ELIMINATES DRILLING RAIL AND SIMPLIFIES RELOCATION**
- \* **MOUNTS ON VERTICAL OR HORIZONTAL RAILS**
- \* **ADJUSTABLE FOR RAILS 7/8 TO 1 INCH IN DIAMETER AND BY REDUCING MOUNTING BOLT LENGTH, 3/4 INCH DIAMETER RAILS**



**ORDERING INFORMATION**

I.D. Tube Inches	O.D. Tube Inches	Length Overall Inches	Dealer Pkg. 5 Pc.	Weight Pounds
1-5/8	2	9	1215 DP CHR	2

Spare Face Plate with Bolts, Cat. No. 1215 DP 99A.  
Spare Intermediate Plate, Cat. No. 1215 000 99B.

NOTE: The use of a safety line attached to the rod and reel is recommended, particularly when running or fishing with heavy duty rods and reels.



**FIG. 1215**



Rounded Rod Holder Bottom

## FISHING ROD HOLDER, CAP & GASKET KITS AND LINERS, LIPS & TUBES

**FIG. 449 - REMOVABLE FISHING ROD HOLDER**

**CONSTRUCTION:**

- \* CHROME PLATED BRASS AND MANGANESE BRONZE
- \* SOFT BLACK LINER

**DESIGNED FOR VERTICAL MOUNTING, THIS HOLDER IS EASILY REMOVED WHEN NOT IN USE, LEAVING NO PROJECTING HARDWARE.**



**FIG. 449**



**ORDERING INFORMATION**

I.D. Tube Inches	O.D. Tube Inches	Dimensions Bracket Inches	Dealer Pkg. - 1 Card 1 Pc. per Card	Weight Pounds
1-5/8	2	4 x 3-3/4	449 DP CHR	2-1/4

Screw Size #10.

Spare Holder Only, Cat. No. 449 000 99A. Spare Bracket Only, Cat. No. 449 000 99B. Spare Liner with Lip and Tube, Cat. No. 483 DP1 BLK.

**FIGS. 480, 481 & 484 - CAP AND GASKET KITS**

**CONSTRUCTION:**

- \* SOFT BLACK FLANGE GASKET WITH INTEGRAL FLIP-UP CAP
- \* SOFT BLACK LIP

**REPLACEMENT OR UPGRADE FOR OLDER HOLDERS**



**FIG. 480**



**ORDERING INFORMATION**

To Fit Catalog Number	Dealer Pkg. - 5 Cards 1 Kit per Card	Weight Ounces
448 DP1 CHR	480 DP BLK	3
1205 DP CHR	480 DP BLK	3
452 DP STS	481 DP BLK	3
447 DP1 CHR	484 DP BLK	3



**FIGS. 482 & 483 - LINERS, LIPS AND TUBES**

**FOR FISHING ROD HOLDERS**

Except Fig. Nos. 404 #1, 447, 1099, 1100, 1104, 1118 and 1215.



**FIG. 482**

**FIG. 483**



**ORDERING INFORMATION**

I.D. Inches	For Angled Flush Mount Complete Dealer Pkg. - 5 Cards 1 Set per Card	For All Others Complete Dealer Pkg. - 5 Cards 1 Set per Card	Spare Lip Only For Fig. 482 Dealer Pkg. - 5 Cards 1 Pc. per Card	Spare Lip Only For Fig. 483 Dealer Pkg. - 5 Cards 1 Pc. per Card
1-5/8	482 DP1 BLK	483 DP1 BLK	482 DP1 99A	483 DP1 99A
1-7/8	482 DP2 BLK	483 DP2 BLK	482 DP2 99A	483 DP2 99A

