

Manufacturer of Marine Lights, Hardware and Accessories

PERKO®

We Make it Right, Right Here!!

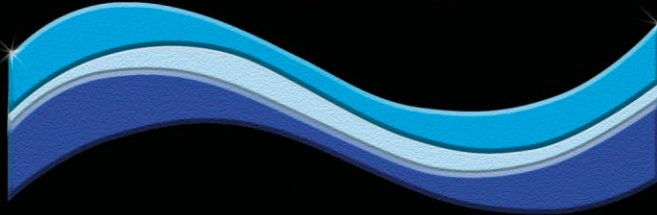

Catalog No. 310



ISO 9001:2008 Certified

COVER PHOTOGRAPH

Jupiter Lighthouse

Jupiter Inlet, Florida

Cover Photo By: Richard A. Cozier



The Jupiter Lighthouse is located along the Loxahatchee River at the Jupiter Inlet in Jupiter, Florida. She stands on a 41 foot natural hill of shell and marine sand. Due to the numerous shipwrecks over the years that were caused by the sandbars and submerged reefs along the Florida coast, Congress in 1853, finally appropriated \$35,000 to erect "a first-order lighthouse" to mark the reef lying off the Jupiter Inlet and act as an aide to navigation. Construction began in 1855, but a series of delays due to the Third Seminole Indian War raging across Florida and "Jupiter Fever" (Yellow fever and malaria epidemics were common), contributed to cost overruns as the final expenditure ran over \$60,000 at the time of completion.

The lighthouse was finally completed in 1859, and went into service on July 10, 1860. The special lenses were designed by Augustin Jean Fresnel and ground in the glassworks in France. The lighthouse had no more recovered from the Indian Wars when the Civil War began to darken the lighthouses along the southeastern coast. The Jupiter and the Cape Florida Lighthouses were still operating until Confederate sympathizers removed the light mechanism and hid it in the Jupiter Creek area. After the war ended, the parts of the illuminating apparatus were found and on June 28, 1866 the light flashed once again. During the 1928 hurricane, the lighthouse went through yet another crisis. According to local history, the hurricane was so intense "that the tower swayed up to seventeen inches, the magnifying bulls-eye lens was blown out and the mortar under the iron cage holding the lamp was squeezed out." The "broken eye" was salvaged and the pieces were shipped to Charleston, South Carolina where they were put together again. An iron bar was placed across them as it now stands today.

The 105 step stairway ascends into the Watch room through a small hatch in the floor. The Watch room is the heart of the lighthouse, as the keepers worked here cleaning the lens and surrounding glass, trimming the lamp wicks, polishing the brass, and winding the turning mechanism weights. The lighthouse has a first order flashing Fresnel lens. The lens resembles a beehive as it is composed of many sections of glass set into a framework that looks like a single piece. The glass sections are shaped into prisms that refract or bend light toward a powerful magnifying glass in the center of the frame. This glass is called a 'bulls eye' and intensifies the light. The flashing light of the lighthouse uses a clockwork mechanism to rotate the lens at specific intervals. The intervals form a pattern of flashes and each pattern is unique to a particular lighthouse. Mariners can then locate their position at sea by identifying a flash pattern. The light is visible from 18 to 25 miles at sea.

Major George G. Meade designed the Jupiter Lighthouse, along with four other lighthouses in the Florida Keys. Ten years later, he became well known as the general who won at the Battle of Gettysburg near the end of the Civil War. Several other historical figures got their start or served in the Seminole Wars near the Jupiter lighthouse before going on to future prominence. They included future president, Andrew Jackson, General William T. Sherman and Major Robert Anderson. In 1817, Andrew Jackson led the First Seminole Indian War. Civil War icon General Sherman had been stationed at Fort Pierce in 1841 during the second Seminole War and Major Robert Anderson, Commanding officer at the attack on Fort Sumter, was a Lieutenant while on duty at Fort Jupiter.

Today the Jupiter Lighthouse is open on Sundays from 1 to 4 p.m.. Volunteers man the lighthouse for the Loxahatchee Historical Society.

CATALOG No. 310

		Pages
	The Perko Story and Modern Facilities	2 to 6
	General Info, Sales Representatives and Understanding Navigation Light Certifications	7 to 9
1.	Navigation Lights for Vessels <u>Under</u> 20 Meters	12 to 72
2.	Navigation Lights for Vessels <u>Over</u> 20 Meters	73 to 88
3.	Searchlights	89 to 110
4.	Lighting Fixtures, Bulbs, Electrical and Battery Switches	111 to 135
5.	Compartment Ventilators and Fog Bells	136 to 141
6.	Underwater Hardware	142 to 161
7.	Deck Plates, Fills and Tank Vents	162 to 183
8.	Deck Hardware	184 to 207
9.	Cabinet Hardware, Hinges, Locks and Latches	208 to 244
10.	Fishing Equipment	245 to 248
11.	Numerical Index	249 to 252
12.	Alphabetic Index	253 to 256

PERKO®

Proudly Made in America for Over 100 Years

Manufacturer of Ship and Boat Equipment

Street Address:

16490 Northwest 13th Avenue
 Miami, Florida 33169-5707

Telephone Number: (305) 621-7525

Fax Number: (305) 620-9978

Mailing Address:

P.O. Box 64000D
 Miami, Florida 33164-0510

e-mail: sales@perko.com

Website: www.perko.com

THE PERKO STORY

1st Generation



Frederick Perkins
Founder 1907-1947

2nd Generation



Louis E. Perkins
Co-Founder/President 1947-1964

3rd Generation



Marvin Perkins
President 1964-1997
Chairman 1997 to Present

4th Generation



Frederick M. Perkins
President 1997-Present

5th Generation



Cameron Perkins
1999-Present



Deborah Perkins
2002-Present

Frederick Perkins (Mendel Persky) born in Russia in 1874 and schooled as a machinist (tool & die maker) in Germany, immigrated to this country in 1889 at the age of 15 and became a naturalized U.S. citizen in 1898. In the early 1900's, Frederick started the original family business as a tool and die manufacturer out of his basement, as F. Persky & Co., at 49 Elizabeth Street in New York City.

In 1907, Fred Perkins was joined by his cousin Max Persky who was also a machinist. By 1910 the business had grown, and they moved down the street to 52 Elizabeth Street. At that time the company had approximately 12 or 14 employees and was established in the business of making small machine parts,

tubular type bicycle pumps, head lights for automobiles and small lanterns which the dime stores filled with candy. When a customer did not pay him for a set of marine lantern dies, he started marketing the lights he manufactured from that set of tools.

Between 1910 and 1912 the National Marine Lamp Company was formed by a combination of F. Persky & Company, H.A.J. Helvig and Company and American Lamp Works. The main headquarters for National Marine Lamp was located at 23 Brook Street in Forestville, Connecticut in a very large building that once had been a thread mill. They also maintained a sales office in New York City.

By 1913 Fred Perkins had moved to Connecticut and F. Persky & Company

ceased independent operations. During that same year, Fred Perkins was listed in the company annual report as the president of National Marine Lamp Company.

From 1913 until late 1916, Fred Perkins operated as the head of National Marine Lamp Corp. In late 1916, he left that firm and opened a new company, Perkins Marine Lamp Company which was incorporated in early 1917. The company set up operations in the remote farmlands of Brooklyn and operated in the Brooklyn, New York facility at 1943 Pitkin Avenue until 1959. The original plant consisted of one three story building of which the two top floors were leased out to independent operations. New products were added to the line and sales activities expanded beyond the Northeast. Perko

PERKO®

THE PERKO STORY

offered cast bronze lights and hardware, first to the maritime industry, then to the growing pleasure boat market.

It was also around the time of Fred Perkins' move to Brooklyn in 1916 that his son Louis E. Perkins began working with the company full time. In 1922, the now famous "PERKO" trademark was introduced.

In the late 1920's the company introduced copper and nickel plated products from its own plating department. When chromium plating was perfected in the 1930's, the first Perko chromium-plated hardware appeared. As Perko's reputation for quality increased, the company's manufacturing facility expanded and enjoyed exceptional growth into the 1930's. It was during the 1930's that Perko established itself as a full-time manufacturer of marine lights, hardware, and accessories for the pleasure boating market. This tremendous growth created the need for more facilities. The original one-story manufacturing plant in Brooklyn grew to five stories. Then six more buildings were added until finally there was no more room for expansion.

In 1932 the Perkins Marine Lamp Company corporate name was changed to Perkins Marine Lamp & Hardware Corporation, since by that time the company was becoming heavily involved in supplying the marine trade with not only navigation and decorative lights but a variety of hardware fittings for the maritime and pleasure boat market.

Louis Perkins became President in 1947 upon the passing of his father Frederick. It was also in that year that his son Marvin joined the firm. In 1959, Louis and Marvin decided to move the entire operation to a new facility in Miami, Florida. Lou's first objective at the new facility was to put everything under one roof. This meant the elimination of subcontractors and the addition of a whole range of in-house production capabilities—from mill material to finished product.

Also in 1959, Leroy F. (Roy) Hollenbeck joined Perko applying his background in manufacturing and production to assist in coordinating the layout and supervise construction of the new plant. Roy's experience in plating, engineering and design helped to improve the product line and manufacturing techniques.

The new building opened in 1960 with approximately 78,000 square feet putting all the manufacturing and offices on one floor under one roof. That facility was expanded to 90,000 square feet with the

addition of a non-ferrous foundry for brass, bronze and aluminum casting in mid 1961.

By 1965, a 47,000 square foot extension was completed to house the sophisticated die-casting system that now produces zinc and bronze parts.

Marvin's son Fred Perkins, named after his great-grandfather, became the 4th generation of the Perkins family involved in the company and quickly established himself as one of the marine industry's most knowledgeable authorities on navigational light requirements. Fred started in 1969 while still attending school and became active on a full time basis in 1973. He was named assistant Vice President of manufacturing in early 1974 and in 1978 became company Secretary. His background in engineering and electronics proved to be a welcome asset to help keep the product line up to date. Over the years the company had become better known for its "PERKO" trademark. In 1976 it was decided to change the company name to Perko Incorporated.

In 1979, a 35,000 square foot plastics injection molding facility was added to enable us to produce all of the polymer products and components for our diverse product line.

Fred became president in 1997. Then in 1999 Fred's son Cameron joined the company and in 2002 his daughter Deborah joined the family business marking the 5th generation and setting the course for the future.

Today, PERKO is truly an integrated manufacturer, almost completely independent of outside vendors, with the exception of a few basic items such as light bulbs and electric wire. A whole range of complete in-house capabilities, from product design through manufacturing and assembly of finished products, enables us to eliminate most subcontractors and obtain better control of our product quality, cost and delivery.

Our sand casting foundries help us control the production of our high quality brass, bronze and aluminum castings, and offers assurance that the proper alloy is used for each job.

PERKO is the only domestic marine manufacturer producing die-cast bronze parts which are well known for strength, uniformity and quality.

Our diverse press department utilizes a variety of forming tools, including multi-stage, progressive tooling produced in our

tool room. Our large, conventional machine shop includes many secondary operations such as drilling, tapping and assembly. A separate machine shop houses a number of modern, high speed automatic chuckers for high volume items, and our three separate polishing divisions assure the correct finishing procedure for each product.

In 2005 our facility was rewired for a state-of-the-art computer network and enterprise resource planning (ERP) operation, which is taking us into the next century. Expansion continues with the substantial addition to our foundry of an Investment Casting operation. Our in-house printing, graphics and pre-press department produces almost all of our printed materials from packaging materials, box labels and instructions to full color catalogs and marketing materials. In total, careful planning over the years has enabled us to become virtually self sufficient in every department.

Throughout all of our operations, steps have been taken to efficiently assure production of the highest quality products. PERKO has been an ISO registered company since 1994. Our products are designed and manufactured to meet or exceed various standards, including ISO 9001-2008, USCG, UL, NMMA and other industry standards as well as our own quality specifications. Quality control is consistently maintained and every step forward, from our founding to the present day, has been undertaken with our customer in mind. Each PERKO product is thoroughly evaluated for safety, appearance and function.

It has always been our objective to provide our customers with the very best in marine lights, hardware and accessories at competitive prices. The marketplace has rewarded our emphasis on quality with ever increasing sales and reputation. Designed and built to the highest specifications, all PERKO products are backed with outstanding warranties and our commitment to excellence. It's a "PERKO Plus" you can count on!

To date, the PERKO facility spans 15 plus acres and over 440,000 square feet of manufacturing capability. As an American manufacturer, staying competitive today in a constantly changing global market place presents many challenges, but our vision is steadfast as we move into the next century of business. Perko maintains its commitment to quality and is proud of its heritage as an American success story for over 100 years.

PROUDLY MADE IN AMERICA FOR OVER 100 YEARS

PERKO® OUR MODERN SELF-CONTAINED FACILITY



Above: 440, 000 Sq. Ft. Home of PERKO, Inc
Located on 16 Acres in Miami, FL



Above: Computerized Tool & Die Department



Above & Left:
Gold Plating Line



Above & Left:
PERKOPLATE
Chrome Plating Operations

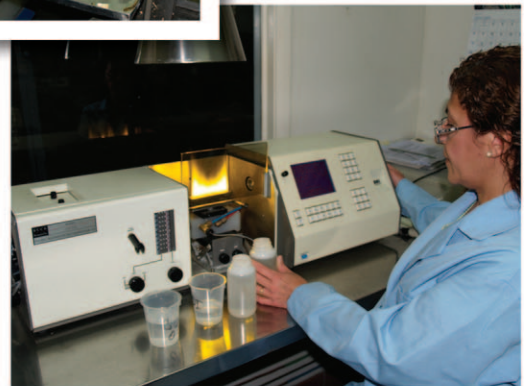

Above: Quality Control Atomic Absorption
Spectrophotometry

OUR MODERN SELF-CONTAINED FACILITY



Above: CNC Lathes and Milling Centers



Below: CNC Multi Access Milling Machines



Above: CNC Drilling & Tapping Centers



Above: Computerized Auto Robotic Polishing Centers



Above: Sand Cast Foundry



Right: Zinc & Bronze Die Cast



Above: Plastics Injection Molding

PERKO® OUR MODERN SELF-CONTAINED FACILITY

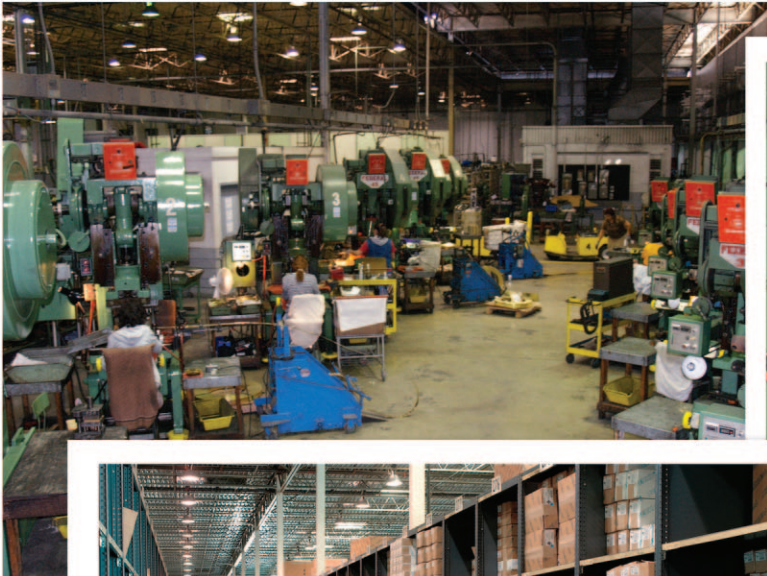

Left & Below:
Mechanical Power Press Department



Below:
General Assembly Department



Above:
Finished Goods Inventory



Above & Right: Ultrasonic Welding
Packaging Centers



Above:
Navigation Light Assembly

SALES POLICY

PERKO Products are sold through our established Distributors. We do not sell direct to the public or organizations. Therefore, possession of this catalog does not infer an offer to sell. Please contact your local marine supplier or visit our website www.perko.com to find a supplier near you.

PRICES AND TERMS

Our costs can change due to causes beyond our control. Therefore, our price list is only intended for the guidance of our customers and does not necessarily establish current prices. All prices are subject to change without notice.

Orders from firms having no satisfactory history or credit rating with us must be prepaid. C.O.D. shipments will be made if a 25% deposit is sent with the order. Cash discounts do not apply to C.O.D. shipments.

DESIGNS

For the purpose of continuous improvement in our products, the designs and specifications are subject to change without notice.

RETURN GOODS

A Repackaging Service Charge of \$10.00 net will apply to all broken packages. Products made to order are not returnable. Stock products in new, saleable condition are only returnable when permission has been granted by us, and are subject to handling and repackaging charges. Return shipping charges must be prepaid. Purchase date and invoice number are required when requesting an R.G.A. (Return Goods Authorization) number. Permission must be requested within 30 days after receipt of goods.

WEIGHTS

The weights given in this catalog are approximate, but should be sufficient for general purposes.

SHIPPING INSTRUCTIONS

Customers should send specific shipping instructions; otherwise, we will use our own judgement in selecting route.

SHIPMENTS

F.O.B. our plant, Miami, Florida, unless quoted otherwise. We are not responsible for damage, loss or delay after goods are delivered to carrier. When loss or delay occurs, we will gladly assist in tracing or expediting, but such assistance is no criterion of responsibility.

When there is **loss or apparent visible damage** to a shipment when tendered for delivery, **do not** give the carrier a clear receipt. Note such damage on the carrier's delivery receipt and **have the driver sign the receipt.**

CONCEALED DAMAGE OR LOSS

1. Advise the delivering carrier in writing as soon as discovered or no more than 15 days after delivery, and request carrier to make an inspection.
2. **Retain,** for the carrier's inspection, the **container and all packaging** with which the damaged or lost material was packaged.
3. **Shortages** - Must be reported to us within 15 days after receipt of goods.

**PERKO®
LIMITED WARRANTY**

PERKO, INC. (PERKO) warrants to the original consumer-purchaser that PERKO'S products will be free from defective materials or workmanship, and that the PERKOPLATE/PERKO•KOTE finish will remain corrosion-free under normal use and service, for a period as shown below from the original purchase date:

Product Class	Duration
Products installed by a manufacturer as original equipment	1 year or duration of the manufacturer's general accessory warranty, whichever is longer
Commercial products (and/or products used in commercial service) and searchlights	1 Year
Products not included above and which are purchased over-the-counter at a retail dealer	5 Years

ALL IMPLIED WARRANTIES, INCLUDING MERCHANTABILITY, ARE ALSO LIMITED IN DURATION TO THE WARRANTY PERIOD FROM THE ORIGINAL PURCHASE DATE.

PERKO SHALL NOT BE LIABLE FOR LOSS OF USE OF ANY OF ITS PRODUCTS, NOR FOR OTHER INCIDENTAL OR CONSEQUENTIAL COSTS, EXPENSES, OR DAMAGES INCURRED BY THE ORIGINAL PURCHASER OR BY ANY OTHER PERSON.

SOME STATES DO NOT ALLOW LIMITATIONS ON HOW LONG AN IMPLIED WARRANTY LASTS, SO THE ABOVE LIMITATION MAY OR MAY NOT APPLY TO YOU. SOME STATES DO NOT ALLOW THE EXCLUSION OR LIMITATION OF INCIDENTAL OR CONSEQUENTIAL DAMAGES, SO THE ABOVE LIMITATION OR EXCLUSION MAY OR MAY NOT APPLY TO YOU.

This warranty is void if the product warranted has been damaged by accident or unreasonable use, neglect, improper service or other cause not arising out of defects in material or workmanship. Excluded from this warranty are electric light bulbs (lamps), sealed beam units and fuses. Specific warranty statements made on the smallest unit package, on the individual instruction/installation sheets, or on price quotations which accompany certain specialty, custom or individual products shall supersede this warranty.

During the warranty period, your PERKO product will either be repaired or it will be replaced with a like product (at PERKO's option) without charge to the original consumer-purchaser, when returned prepaid and insured, with proof-of-purchase date to PERKO at our factory in Miami, FL. In the event of replacement, the replacement product will continue the warranty of the original product, or ninety (90) days, whichever is longer. **Important: For this Warranty to be effective, PERKO must be supplied with Proof-Of-Purchase date of the product.**

PERKO does not authorize any person or company to create for it any other obligation or liability in connection with any of its products.

UNDERSTANDING NAVIGATION LIGHT CERTIFICATIONS

All U.S. registered vessels are subject to either the '72 COLREGS or the U.S. inland rules. Effective 11/1/03, lights must meet one of 3 types of certifications depending on the size of the vessel and the date it was manufactured.

LARGE BOATS OVER 20 METERS (65.6 FT.)

The U.S. Coast Guard is accepting lights that have passed the UL tests (UL Standard 1104) as meeting the '72 COLREGS and the U.S. Inland Rules for vessels over 20 meters (65.6 ft.). As the first domestic manufacturer to pass UL 1104, PERKO's lights can be installed on vessels over 20 meters (65.6 ft.). PERKO manufactures two sizes of lights for the large boat market. The first group of lights is for vessels between 20 meters and 50 meters. The second group includes larger lights and is for vessels over 20 meters (without an upper limit on length).

A brass tag is permanently affixed to the light indicating the type of light, catalog number, voltage and bulb type to install to meet the visibility requirements. It also states that the light is classified by UL in accordance with the '72 COLREGS. This is the only documentation needed by a vessel in this size range for navigation lights to certify light construction compliance with the '72 COLREGS and the U.S. Inland Rules.

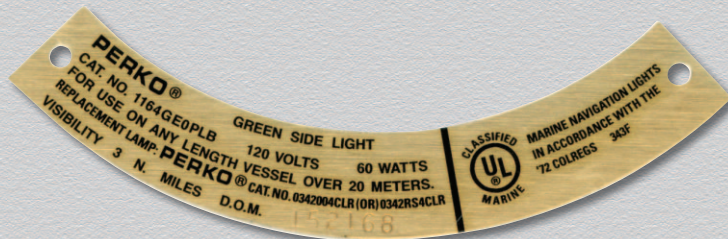

SMALL BOATS⁽¹⁾ UNDER 20 METERS (65.6 Ft.)

U.S. requirements for smaller vessels are less strict and they differ depending on when the boat was built.

SMALL BOATS BUILT BEFORE 11/1/03

Lights for these boats must be manufactured in accordance with the American Boat and Yacht Council (A.B.Y.C.) Standard A-16. The primary means of certification recognized in the United States for lights for these boats is through the National Marine Manufacturers' Association (NMMA) certification procedure. USCG approved lights, as described below, are also approved for these applications. All PERKO small boat lights designed for use on boats built before 11/1/03 are certified under this NMMA Certification Procedure. All lights certified under this procedure are required to permanently carry the mark "A-16" visibly displayed when the light is installed.

**A-16
MARKING**

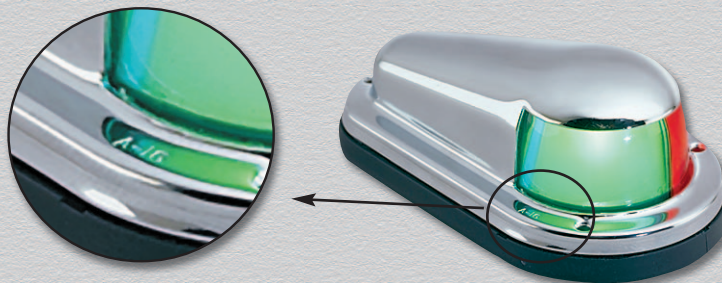

SMALL BOATS BUILT AFTER 11/1/03

The only recognized means of certification of lights for these boats is the USCG approval system. This system uses independent, 3rd party USCG approved labs to conduct some of the tests required for the A-16 certification. On all USCG approved lights, the permanent marking USCG 1nm, USCG 2nm or USCG 3nm (depending on whether the light is a 1-mile, 2-mile or 3-mile light) must be visible when the light is installed. Note that certifications may vary with voltage (e.g. USCG approved for 12-volt and A-16 certified for 24-volt).

**USCG 2nm
MARKING**

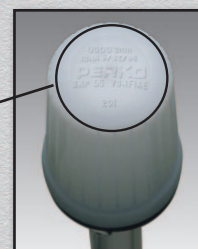

(1) Does not apply to vessels under 7 meters which are not powered

REGIONAL AND INTERNATIONAL SALES REPRESENTATIVES

UNITED STATES & CANADA

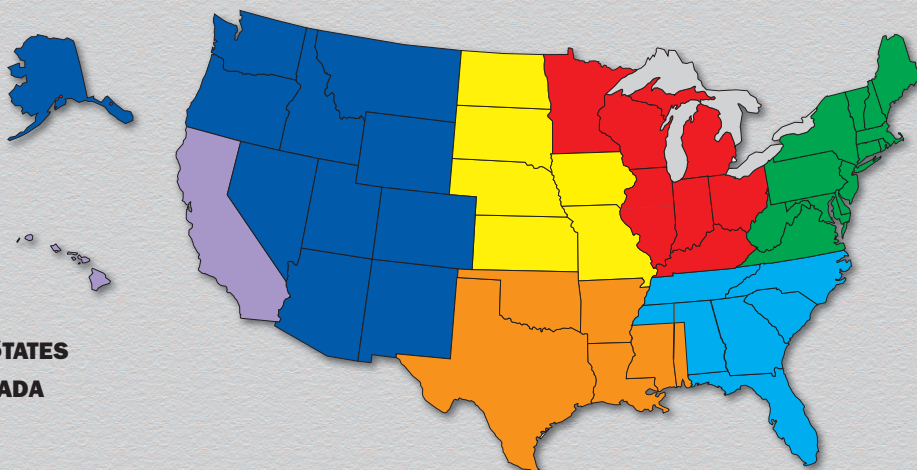

NORTHEAST

ME, NH, VT, NO. MASS, PRINCE EDWARD ISLAND, NEW FOUNDLAND, NOVA SCOTIA & NEW BRUNSWICK
 CGW Associates
 P.O. Box 414, 354 Country Way
 Scituate, MA 02066
 Phone: 781-545-3790 Fax: 781-545-0359
 E-Mail: CGWCO@aol.com, Cell: 617-480-6559
CHARLES W. O'CONNOR

LONG ISLAND NY, SO. MASS., RI, NO. NJ
 CGW Associates
 137 Brandt Island Road
 Mattapoisett, MA 02739
 Phone: 508-758-2980 Fax: 508-758-9705
 E-Mail: CGWWO@aol.com, Cell: 617-513-5152
WAYNE OLIVIERA

MD, VA, SO. NJ, DE, PA
 CGW Associates
 1070 Ulmstead Circle, Arnold, MD 21012
 Phone: 410-757-9630 Fax: 410-757-4365
 E-Mail: KWCGW@aol.com, Cell: 410-808-3048
KEVIN WILLIAMS

UPSTATE NY, ONTARIO, MANITOBA & QUEBEC CANADA
 CGW Associates
 220 Pine Street, Gauanoque, ON Canada K7G1T4
 Phone: 705-790-7686 Fax: 613-382-4964
 E-Mail: davealford@rogers.com, Cell: 705-790-7686
DAVE ALFORD

SOUTHEAST

The Gartner Group
 3313 Highway 70 East, New Bern, NC 28560
 Phone: 252-633-1210 Fax: 252-633-1692
 E-Mail: ken@thegartnergroup.com, Cell: 252-349-1328
 E-Mail: bill@thegartnergroup.com
KEN WILLIAMS & BILL THOMPSON (OFFICE MANAGER)

NC, SC & Georgia
 The Gartner Group
 3313 Highway 70 East, New Bern, NC 28560
 Phone: 252-633-1210 Fax: 252-633-1692
 E-Mail: troy@thegartnergroup.com, Cell: 252-675-1764
TREY BRADLEY

SOUTH FLORIDA
 The Gartner Group
 110 N. Federal Hwy, #804, Ft. Lauderdale, FL 33301
 Phone: 954-530-7223 Fax: 954-530-7209
 E-Mail: doug@thegartnergroup.com,
 Cell: 954-303-4541
DOUG PETERSON

TN, AL, MS & FLORIDA PANHANDLE
 The Gartner Group
 Mac-Hugh & Associates
 9411 Raven Hollow Rd, Brentwood, TN 37027
 Phone: 615-370-4132 Fax: 615-373-3867
 E-Mail: bob@thegartnergroup.com, Cell: 615-584-0492
ROBERT TAYLOR

NORTH FLORIDA
 The Gartner Group
 1025 S. Semoran Blvd. Suite 1093,
 Winter Park, FL 32792
 Office/Cell: 407-620-7506, Fax: 888-203-6494
 E-Mail: tripp@thegartnergroup.com,
TRIPP HAMMACK

MIDWEST 1

MO, IA, ND, SD & NE
 Midwestern Sales Co., Inc.
 9849 Briar Drive, Overland Park, KS 66207
 Phone: 913-648-6132 Fax: 913-648-2885
 E-Mail: dwills@mwsinc.net, Cell: 913-645-3325
DENNIS WILLS

KS, SOUTHERN MO, & SO. ILLINOIS
 Midwestern Sales Co., Inc.
 3444 S. Fort Avenue, Springfield, MO 65807
 Phone: 417-889-3881 Fax: 417-889-3881
 E-Mail: kmitchell@mwsinc.net, Cell: 417-631-1860
KORY MITCHELL

MIDWEST 2

IL, IN, KY, MN & WI
 Inland Marketing Associates, Inc.
 1071 Highland Ct./P.O. Box 414, Plymouth, IN 46563
 Phone: 574-936-6972 Fax: 866-377-9960
 E-Mail: eddiek@imarep.com, Cell: 574-540-3057
ED KUYKENDALL

MI & OH
 Inland Marketing Associates, Inc.
 500 S. Washington Suite 11, Royal Oak, MI 48067
 Phone: 248-541-4404 Fax: 248-541-4405
 E-Mail: bill@imarep.com, Cell: 248-766-0488
R. WILLIAM BURT

SOUTH CENTRAL

SOUTH CENTRAL TX, OK, AR LA, WESTERN AL, SOUTHERN MS & S.E. AR,
 MAC-HUGH & Associates, Inc.
 5540A Pepsi Street, Harahan, LA 70123
 Phone: 504-734-9411 Fax: 504-734-5144
 E-Mail: mchugh12@bellsouth.net, Cell: 504-494-4479
KYLE MCHUGH, BUZZ HUMPHREY, DAVID HILDRETH, GARRETT MCHUGH & KYLE MICHAEL MCHUGH, JR

WEST

CA & HI
 Pacific Marine Marketing, Inc.
 3368 McGraw Lane, Lafayette, CA 94549
 Phone: 925-284-4855 Fax: 925-284-4856
 E-Mail: w.moore@comcast.net, Cell: 925-788-5628
WAYNE R. MOOERS

NORTHWEST

ALBERTA, AK, BRITISH COLUMBIA, ID, MT, OR, WA, WY, NV, UT, CO, AZ & NM
 West-Line Marine Sales Co.
 Mail: P.O. Box 1564, Lake Oswego, OR 97035
 Shipping: 16598 72nd Ave., Portland, OR 97224
 Phone: 503-639-5275 Fax: 503-684-6399
 E-Mail: westline@verizon.net, Cell: 503-781-1835
BILL PASCHALL

West-Line Marine Sales Co.
 P.O. Box 3369, Redmond, WA 98073
 14227 NE 63rd Ct., Redmond, WA 98052
 Phone: 425-883-4115 Fax: 425-885-1695
 E-Mail: jawede@msn.com, Cell: 425-985-1620
JOHN WEDEBERG

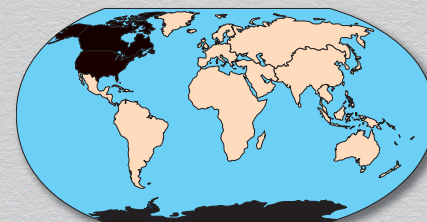

INTERNATIONAL

(EXCLUDING UNITED STATES AND CANADA)
 E&P Marine Inc.
 2425 N.W. 33rd Ave., Miami, FL 33142
 Phone: 305-634-6110 Fax: 305-634-1191
 E-Mail: epmarine@navalex.com
PEDRO L. RODRIGUEZ, MIGUEL A. VASALLO, LARRY CORREA, LILLY DIAZ, EDDY HERNANDEZ

For information on all Export & Foreign Regions Contact Perko, Inc. at sales@perko.com

PERKO Navigation Lights have Gold Plated Contacts!

GO FOR THE GOLD

Gold Plated Contacts Offer:

- Superior Corrosion Resistance
- More Reliable Electrical Connections
- Long Life in Harsh Environments

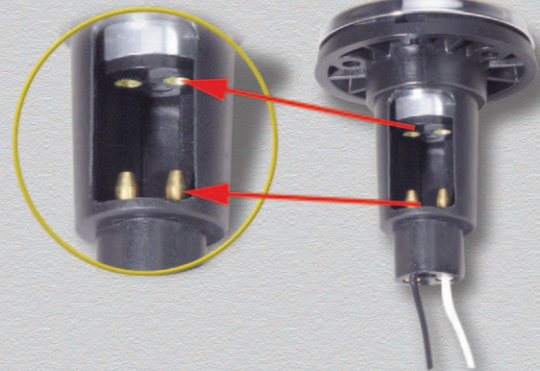
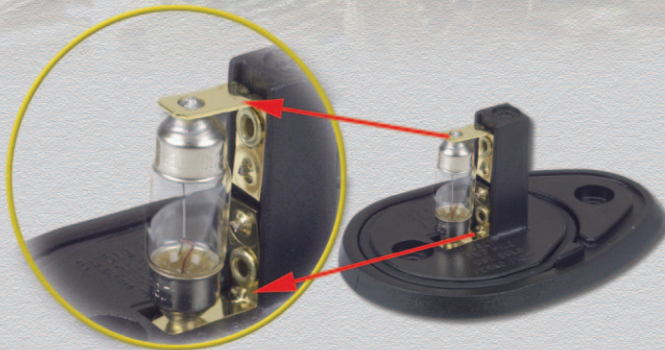

Look for this Symbol

Throughout the catalog
to identify products
with Gold Plated Contacts

Introducing The “White Line”



Great looking “white” versions of many of our most popular items are available to boat builders when ordered in reasonable quantities. Products include navigation lights, fuel fills & vents, locks, latches and interior lights. Polymer parts are molded in white materials while metallic parts are white powder coated. Look for this symbol throughout our catalog for “White Line” products and consult the factory for details.



TRI-COLOR LIGHTS

1

USCG



Patent No. 4,500,947

Red, Green and Clear Lenses

Fig. 0200TAB Tri-color/White All Round Light

Certified For Use on Vessels Under Sail Alone

Under 20 Meters (65.6 ft.) in Length

CONSTRUCTION:

- Base Mount
- Black Polymer
- 12, 24 or 32 Volt Bulbs Included



Fig. 0200 TAB

ORDERING INFO

Voltage	Vertical Height Inches	Dealer Pkg. - 5 Cards 1 Pc. per Card	Ship Wt. Carton Lbs. Dealer Pkg.
12	8-3/4	0200TABDP1	6.1
24	8-3/4	0200TABDP2	6.1
32	8-3/4	0200TABDP3*	6.1

TECH INFO

- 12 and 24 Volt: USCG
- 32 Volt: A-16
- O.D. Base: 3-5/16"
- Screw Size: #10

Spare Parts Ordering Information

Spare Lens Assembly: 0200TABLNS, for a Bi-Color Top Mount Lens Assembly.

Replacement Bulb Sockets: (Bottom): 0093, (Top): 0095.

Bulb Information Top Section: 12V: 037512V25W, 24V: 037524V25W and 32V: 037532V25W.

Bulb Information Bottom Section: 12V: 037512V10W, 24V: 037524V10W and 32V: 037532V10W.

NOTE: Fig. 0200TAB meets the USCG requirements for 12 & 24 volt applications.

*Fig. 0200TAB 32-volt can only be used as a replacement light on boats built prior to 11/1/03.

To use as 12, 24 or 32-volt lights while maintaining the proper certifications, replace the bulbs provided as indicated above.

USCG



Fig. 1201 Tri-Color Light

Certified For Use on Vessels Under Sail Alone

Under 12 Meters (39.4 ft.) in Length

CONSTRUCTION:

- Black Polymer and Chrome Plated Zinc Alloy Top
- Black Polymer Base
- 12 Volt Bulbs Included



Fig. 1201

ORDERING INFO

Vertical Height Inches	Dealer Pkg. - 5 Cards 1 Pc. per Card	Ship Wt. Carton Lbs. Dealer Pkg.
3-1/4	1201DPOBLK	2.2

TECH INFO

- 12 Volt: USCG
- 24 Volt: A-16
- Base Dimensions:
1" x 2-5/8"
- Screw Size: #8

SPARE PARTS ORDERING INFORMATION

Bi-Color Lens Set (Red/Green): 0268DPOLNS.

White Lenses (2 per card): 0278DPOWHT.

12V Bulbs (2 per card): 0071DPOCLR.

Top Cap with Screw: 1158DPOBLK.

NOTE: Fig. 1201 meets the USCG requirements for 12-volt applications. Fig. 1201 can also be used as a 24-volt A.B.Y.C. A-16 certified light on boats built prior to 11/1/03. To use as a 24-volt light while maintaining A-16 certification, replace the bulbs provided with Cat. No. 0072DP1CLR 24-volt bulbs. Contact us for 24-volt applications on new construction.

VERTICAL MOUNT SIDE LIGHTS

Fig. 0617 *STEALTH* Series L.E.D. Side Lights

Patent Pending

Certified For Use on Power Driven Vessels
Under 12 Meters (39.4 ft.) in Length

CONSTRUCTION:

- Stainless Steel, Black or White PERKO•KOTE
- Ultra Low Profile

L.E.D. Features

- Uses 10% of the Energy Draw of Standard Lights
- Low Heat
- Long Life



1



Fig. 0617
Stainless

Fig. 0617
Black

Fig. 0617
White

ORDERING INFO

Finish	Dealer Pkg. 1 Card 1 pair. per Card	OEM Bulk Pkg. 10 Pairs	Ship Wt. Carton Lbs. DP/OEM Bulk
Stainless	0617DP0STS	0617000STS	0.8/5.5
Black	0617DP0BLK	0617000BLK	0.8/5.5
White	0617DP0WHT	0617000WHT	0.8/5.5

TECH INFO

- 12 Volt
- Projection: 5/8"
- Length: 2-1/2"
- Width: 2-5/8"
- Screw Size: #8



Spare gasket kit required for mounting on metallic surfaces (optional for fiberglass surfaces) 0617000GKT (included in D.P. package).

Fig. 0602 L.E.D. Side Lights

Certified For Use on Power Driven Vessels
Under 20 Meters (65.6 ft.) in Length

CONSTRUCTION:

- Chrome Plated Bronze, White Epoxy Coated Bronze or Black Polymer
- Low Profile - Small Size



Fig. 0602 Black

Fig. 0602 White



Fig. 0602 Chrome

ORDERING INFO

Finish	Voltage	Dealer Pkg. 1 Card 1 Pair per Card	OEM Bulk Package 1 Pair	Ship Wt. Carton Lbs. DP/OEM Bulk
Chrome	12	0602DP1CHR	0602001CHR	1.1/0.6
White	12	0602DP1WHT	0602001WHT	1.0/0.6
Black	12	0602DP1BLK	0602001BLK	0.8/0.4
Chrome	24	0602DP2CHR	0602002CHR	1.1/0.6
White	24	0602DP2WHT	0602002WHT	1.0/0.6
Black	24	0602DP2BLK	0602002BLK	0.8/0.4

TECH INFO

- 12 or 24 Volt
- Length: 3-1/4"
- Width: 2"
- Projection: 1-1/8"
- Screw Size: #8

L.E.D. Features

- Uses 10% of the Energy Draw of Standard Lights
- Low Heat
- Long Life



VERTICAL MOUNT SIDE LIGHTS

1

USCG



Fig. 0264



Fig. 0264 Side Lights

Certified For Use on Power Driven Vessels Under 20 Meters (65.6 ft.) in Length

CONSTRUCTION:

- Chrome Plated Zinc-Alloy with Black Polymer Base
- Red and Green Lenses
- 12 Volt Bulbs Included

ORDERING INFO

Dealer Pkg. 5 Cards 1 Pc. per Card	OEM Bulk Pkg. 10 Pcs.	Ship Wt. Carton Lbs. DP/OEM Bulk
0264M00DP1	0264M0012V	4.2/7.1

TECH INFO

- 12V Bulb Included
- Projection: 7/8"
- Length: 3-1/2"
- Width: 2-1/4"
- Screw Size #8

SPARE PARTS ORDERING INFORMATION

Green Lens Only: 0277DPGLNS. Red Lens Only: 0277DPRLNS.
12 Volt Bulbs (2 per card): 0071DP8CLR Base with Socket Assembly: 0254BLK99A.

NOTE: Fig. 0264 meets the USCG requirements for 12-volt applications. It can also be used as a 24-volt A.B.Y.C. A-16 certified light on boats built prior to 11/1/03. To use as a 24-volt light while maintaining A-16 certification, replace the bulbs provided with Cat. No. 0072DP8CLR 24-volt bulbs. Contact us for 24 volt applications on new construction.

USCG



Fig. 0254 Chrome



Fig. 0254 Black



Fig. 0254 White

Fig. 0254 Side Lights

Certified For Use on Power Driven Vessels Under 20 Meters (65.6 ft.) in Length

CONSTRUCTION:

- Chrome Plated Bronze with Black Polymer Base or All Black Polymer or All White Polymer
- Red and Green Lenses
- 12 Volt Bulbs Included

ORDERING INFO

Finish	Dealer Pkg. 5 Cards 1 Pair per Card	OEM Bulk Pkg. 10 Pairs	Ship Wt. Carton Lbs. DP/OEM Bulk
Chrome	0254M00DP1	0254M0012V	3.2/5.4
Black	0254B00DP1	0254B0012V	2.4/3.6
White	0254W00DP1	0254W0012V	2.4/3.6

TECH INFO

- 12V Bulb Included
- Projection: 7/8"
- Length: 3-1/2"
- Width: 2-1/4"
- Screw Size: #8

SPARE PARTS ORDERING INFORMATION

Green Lens Only: 0277DPGLNS. Red Lens Only: 0277DPRLNS.
12 Volt Bulbs (2 per card): 0071DP8CLR.
Base with Socket Assembly: 0254(BLK/WHT)99A.

NOTE: Fig. 0254 meets the USCG requirements for 12-volt applications. The above light can also be used as 24-volt A.B.Y.C. A-16 certified lights on boats built prior to 11/1/03. To use as 24-volt lights while maintaining A-16 certification, replace the bulbs provided with 0072DP8CLR. Contact us for 24 volt applications on new construction.

VERTICAL MOUNT SIDE LIGHTS

Fig. 0170 Side Lights

Certified For Use On Sail or Power Driven Vessels
Under 20 Meters (65.6 ft.) in Length



0170 TECH INFO

- Projection Overall: 2-1/2"
- Height Overall: 3-5/8"
 - Width: 4-1/8"
 - Screw Size: #10
- 12 or 24 Volt Bulb Included

CONSTRUCTION:

- Chrome Plated Brass Top with Black Polymer Base, All Black or White Polymer
- Red and Green Lenses

Note: Old 12 volt 0120 Series lights are superseded by the 0170 Series



Fig. 0170MPO



Fig. 0170BPO

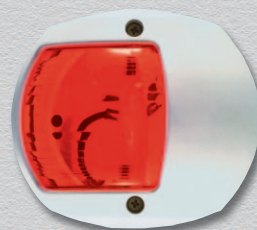

Fig. 0170WPO



Fig. 0170MSD



Fig. 0170BSD



Fig. 0170WSD

FIG. 0170 ORDERING INFO - 12 VOLT

Description	Dealer Pkg.		Ship Wt. Carton Lbs. DP/Std. Pkg.
	5 Cards	Std. Pkg. 1 Pc.	
Chrome	1 Pc. per Card	Std. Pkg. 1 Pc.	
Red Side Light	0170MP0DP1	0170MP012V	2.5/0.5
Green Side Light	0170MSDDP1	0170MSD12V	2.5/0.5
Black Polymer			
Red Side Light	0170BP0DP1	0170BP012V	2.3/0.4
Green Side Light	0170BSDDP1	0170BSD12V	2.3/0.4
White Polymer			
Red Side Light	0170WP0DP1	0170WP012V	2.3/0.4
Green Side Light	0170WSDDP1	0170WSD12V	2.3/0.4

FIG. 0170 ORDERING INFO - 24 VOLT

Description	Dealer Pkg.		Ship Wt. Carton Lbs. DP/Std. Pkg.
	5 Cards	Std. Pkg. 1 Pc.	
Chrome	1 Pc. per Card	Std. Pkg. 1 Pc.	
Red Side Light	0170MP0DP2	0170MP024V	2.5/0.5
Green Side Light	0170MSDDP2	0170MSD24V	2.5/0.5
Black Polymer			
Red Side Light	0170BP0DP2	0170BP024V	2.3/0.4
Green Side Light	0170BSDDP2	0170BSD24V	2.3/0.4
White Polymer			
Red Side Light	0170WP0DP2	0170WP024V	2.3/0.4
Green Side Light	0170WSDDP2	0170WSD24V	2.3/0.4



LED Versions Available. See Page 59.

Note: See Pages 60 & 61 for Complete Series and Spare Parts Ordering Information.

VERTICAL MOUNT SIDE LIGHTS

1

USCG



Fig. 0955

Fig. 0955 Side Lights

Certified For Use on Sail or Power Driven Vessels Under 12 Meters (39.4 ft.) in Length

CONSTRUCTION:

- Chrome Plated Brass or Stainless Steel Top
 - Black Polymer Base
- Red and Green Lenses
- 12 Volt Bulbs Included

ORDERING INFO

Finish	Dealer Pkg. 5 Cards 1 Pair per Card	OEM Bulk Pkg. 10 Pairs	Ship Wt. Carton Lbs. DP/OEM Bulk
Chrome Brass	0955DPOCHR	0955000CHR	2.8/4.7
Stainless Steel	0955DPOSTS	0955000STS	2.6/4.4

TECH INFO

- 12V Bulb Included
- Projection: 5/8"
- Length: 4-14"
- Width: 2-3/8"
- Screw Size: #4

SPARE PARTS ORDERING INFORMATION

Chrome Brass Green Side Light: 0955G00CHR. Chrome Brass Red Side Light: 0955R00CHR.
Stainless Green Side Light: 0955G00STS. Stainless Red Side Light: 0955R00STS.
Base with Socket Assembly: 095500099A. Lens Set (1-Red & 1-Green): 0260DPOLNS.
Bulbs (2 per card): 0071DPOCLR.



Fig. 1264

Fig. 1264 Side Lights

Certified For Replacement Use Only on Power Driven Vessels Under 12 Meters (39.4 ft.) in Length

CONSTRUCTION:

- Chrome Plated Zinc Alloy
- Black Vinyl Mounting Gasket
- Red and Green Lenses
- 12 Volt Bulbs Included

ORDERING INFO

Projection Overall Inches	Dealer Pkg. 5 Cards 1 Pair per Card	Ship Wt. Carton Lbs. Dealer Pkg.
1-3/4	1264DPOCHR	6.6

TECH INFO

- 12V Bulb Included
- Length: 5-1/2"
- Width: 3-1/8"
- Screw Size: #8
- 1 Mile Visibility

SPARE PARTS ORDERING INFORMATION

Green Side Light: 1264G00CHR. Red Side Light: 1264R00CHR.
Lens Set (Red/Green): 1264DPOLNS. Socket Assembly: 1264DP099A.
Bulbs (2 per card): 0071DPOCLR.

NOTE: Fig. 0955 meets the USCG requirements for 12-volt applications. All of the above can also be used as 24-volt A.B.Y.C. A-16 certified lights on boats built prior to 11/1/03. To use as 24-volt lights while maintaining A-16 certification, replace the bulbs provided for Figs. 0955 & 1264 with Cat. No. 0072DP1CLR 24-volt bulbs.

HORIZONTAL MOUNT SIDE LIGHTS

Fig. 0616 *STEALTH* Series L.E.D. Side Lights Patent Pending

Certified For Use on Power Driven Vessels
Under 12 Meters (39.4 ft.) in Length

CONSTRUCTION:

- Stainless Steel, Black or White PERKO•KOTE
- Ultra Low Profile

L.E.D. Features

- Uses 10% of the Energy Draw of Standard Lights
- Low Heat & Long Life



1



ORDERING INFO			
Finish	Dealer Pkg. 1 Card 1 Pair. per Card	OEM Bulk Pkg. 10 Pairs	Ship Wt. Carton Lbs. DP/OEM Bulk
Stainless	0616DPOSTS	0616000STS	0.8/5.4
Black	0616DPOBLK	0616000BLK	0.8/5.4
White	0616DPOWHT	0616000WHT	0.8/5.4

TECH INFO	
• 12 Volt	• Vertical Ht.: 1/2"
• Length: 2-1/2"	• Width: 2-5/8"
• Screw Size: #8	

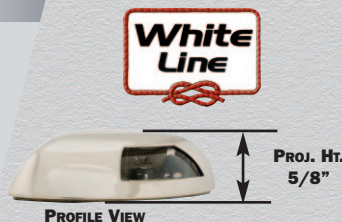

Spare gasket kit required for mounting on metallic surfaces (optional for fiberglass surfaces) 0616000GKT (included in D.P. package).

Fig. 0232 Incandescent Side Lights Fig. 0622 L.E.D. Side Lights

Certified For Use on Power Driven Vessels
Under 20 Meters (65.6 ft.) in Length

CONSTRUCTION:

- Chrome Plated Bronze Top with Black Polymer Base or White PERKO•KOTE Bronze Top with White Polymer Base
- One Piece Lens/Base Assembly
- Includes Mounting Gasket

L.E.D. Version Features

- Uses 10% of the Energy Draw of Standard Lights
- Low Heat & Long Life



ORDERING INFO				
Finish	Dealer Pkg.	OEM Bulk Pkg.	Pkg. Qty. DP/OEM Bulk	Ship Wt. Carton Lbs. DP/OEM Bulk
Chrome	0232DPOCHR	0232000CHR	5/25	5.0/22.3
Chrome L.E.D.	0622DPOCHR	0622000CHR	1/1	1.6/1.5
White L.E.D.	0622DPOWHT	0622000WHT	1/1	1.6/1.5

TECH INFO	
• 12 Volt	• Length: 4"
• Width: 3"	• Screw Size: #8
• Vertical Ht: 7/8"	



FIG. No. 0232 SPARE PARTS ORDERING INFORMATION

Lens & Base Assy (Green): 0232DPGLNS. Lens & Base Assy (Red): 0232DPRLNS.
Bulbs (2 per card): 0071DPOCLR. Base with Socket Assembly: 0229DP099A.

HORIZONTAL MOUNT SIDE LIGHTS

1



Fig. 0228 Side Lights

Certified For Use on Power Driven Vessels Under 20 Meters (65.6 ft.) in Length

CONSTRUCTION:

- Chrome Plated Zinc Alloy Top with Black Polymer Base or White PERKO•KOTE Zinc Alloy Top with White Polymer Base
- Red and Green Lenses
- 12 Volt Bulbs Included

Fig. 0228



ORDERING INFO

Finish	Dealer Pkg. 5 Cards 1 Pair per Card	OEM Bulk Pkg. 25 Pairs	Ship Wt. Carton Lbs. DP/OEM Bulk
Chrome	0228DPOCHR	0228000CHR	3.6/15.4
White	0228DPOWHT	0228000WHT	3.6/15.4

TECH INFO

- 12V Bulb Included
- Length: 3-1/4"
- Width: 2-5/16"
- Screw Size: #8
- Vertical Height: 5/8"

SPARE PARTS ORDERING INFORMATION

Green Lens: 0228DPGLNS. Red Lens: 0228DPRLNS.
Black Base with Socket Assembly: 022700099A. Bulbs (2 per card): 0071DPOCLR.
White Base with Socket Assembly: 0227W0099A.



USCG



Fig. 0253 Side Lights

Certified For Use on Power Driven Vessels Under 20 Meters (65.6 ft.) in Length

CONSTRUCTION:

- Chrome Plated Bronze Top with Black Polymer Base, All Black or White Polymer
- Red and Green Lenses
- 12 Volt Bulbs Included

Fig. 0253
Chrome



Fig. 0253
Black



Fig. 0253
White

ORDERING INFO

Finish	Vertical Height Inches	Dealer Pkg. 5 Cards 1 Pair per Card	OEM Bulk Pkg. 10 Pairs	Ship Wt. Carton Lbs. DP/OEM Bulk
Chrome	13/16	0253M00DP1	0253M0012V	3.8/6.4
Black	13/16	0253B00DP1	0253B0012V	2.2/3.2
White	13/16	0253W00DP1	0253W0012V	2.2/3.2

TECH INFO

- 12V Bulb Included
- Length: 3-1/2"
- Width: 2-1/4"
- Screw Size: #8

SPARE PARTS ORDERING INFORMATION

Green Lens Only: 0273DPGLNS. Red Lens Only: 0273DPRLNS.
Base with Socket Assembly: 0114000BLK/WHT. Bulbs (2 per card): 0071DPOCLR.



NOTE: The above lights meet the USCG requirements for 12-volt applications. All the above can also be used as 24-volt A.B.Y.C. A-16 certified lights on boats built prior to 11/1/03. To use as 24-volt lights while maintaining A-16 certification, replace the bulbs provided with Cat. No. 0072DP1CLR 24-volt bulbs. Contact us for 24-volt applications on new construction.

HORIZONTAL MOUNT SIDE LIGHTS

Fig. 0963 Side Lights

Certified For Use on Sail or Power Driven Vessels Under 12 Meters (39.4 ft.) in Length

CONSTRUCTION:

- Chrome Plated Brass or Stainless Steel Top with Black Polymer Base
- Red and Green Lenses



1

ORDERING INFO				TECH INFO
Vertical Height	Dealer Pkg.	OEM	Ship Wt.	<ul style="list-style-type: none"> • 12V Bulb Included • O.D. Base: 2-3/8" • Screw Size: #8
Inches	5 Cards	Bulk Pkg.	Carton Lbs.	
1 Pair per Card	10 Pairs	DP/OEM Bulk		
Finish				
Chrome	7/8	0963DPOCHR	0963000CHR	2.5/3.9
Stainless	7/8	0963DPOSTS	0963000STS	2.2/3.5

SPARE PARTS ORDERING INFORMATION

Chrome Brass Green Side Light Only: 0963G00CHR. Chrome Brass Red Side Light Only: 0963R00CHR.
 Stainless Green Side Light Only: 0963G00STS. Stainless Red Side Light Only: 0963R00STS.
 Lens Set, Old Style Open Top (Red/Green): 0281DPALNS.
 Lens Set, New Style Closed Top (Red/Green): 0295DPOLNS.
 Bulbs (2 per card): 0071DPOCLR. Base with Socket Assembly: 0135.

Fig. 0963



Figs. 1601/1602 Side Lights - Great for Pontoon Boats

Certified For Use on Sail or Power Driven Vessels Under 12 Meters (39.4 ft.) in Length

CONSTRUCTION:

- Black Polymer with Red and Green Lenses

Fig. 1601 - Normal "Base-Down" Mount

Fig. 1602 - Inverted "Base-Up" Mount



ORDERING INFO				TECH INFO
Vertical Height	Dealer Pkg.	OEM	Ship Wt.	<ul style="list-style-type: none"> • 12V Bulb Included • Height Overall: 1-7/8" • Dimensions Base: 1-1/8" x 3" • Screw Size: #8
Inches	5 Cards	Bulk Pkg.	Carton Lbs.	
1 Pair per Card	25 Pairs	DP/OEM Bulk		
1-1/4	1601DPOBLK	1601000BLK	2.7/10.2	
1-1/4	1602DPOBLK	1602000BLK	2.7/10.2	

SPARE PARTS ORDERING INFORMATION

Red Lens Only: 0298DPRLNS. Green Lens Only: 0298DPGLNS.
 Bulbs (2 per card): 0071DPOCLR. Base with Socket Assembly: 0139000BLK.
 Red Light Only: 1601R00BLK, 1602R00BLK. Green Light Only: 1601G00BLK, 1602G00BLK

Fig. 1601



Fig. 1602

Fig. 0915 Side Lights

Certified For Replacement Use Only on Sail or Power Driven Vessels Under 12 Meters (39.4 ft.) in Length

CONSTRUCTION:

- Chrome Plated Brass or Stainless Steel Top with Black Polymer Base
- Red and Green Lenses



ORDERING INFO				TECH INFO
Vertical Height	Dealer Pkg.	OEM	Ship Wt.	<ul style="list-style-type: none"> • 12V Bulb Included • Length: 4-1/4" • Width: 2-3/8" • Screw Size: #4 • 1 Mile Visibility
Inches	5 Cards	Bulk Pkg.	Carton Lbs.	
1 Pair per Card	10 Pairs	DP/OEM Bulk		
Finish				
Chrome Brass	7/8	0915DPOCHR	3.0	
Stainless Steel	7/8	0915DPOSTS	2.9	

SPARE PARTS ORDERING INFORMATION

Chrome Brass Green Side Light: 0915G00CHR. Chrome Brass Red Side Light: 0915R00CHR.
 Stainless Green Side Light: 0915G00STS. Stainless Red Side Light: 0915R00STS.
 Bulbs (2 per card): 0071DPOCLR. Base with Socket Assembly: 0107.
 Lens Set, Old Style Open Top (Red /Green): 0281DPALNS. Lens Set, New Style Closed Top (Red/Green): 0295DPOLNS.

Fig. 0915



NOTE: Figs. 0963, 1601 & 1602 meet the USCG requirements for 12-volt applications. All the above can also be used as 24-volt A.B.Y.C. A-16 certified lights on boats built prior to 11/1/03. To use as 24-volt lights while maintaining A-16 certification, replace the bulbs provided with Cat. No. 0072DP1CLR 24-volt bulbs. Contact us for 24-volt applications on new construction.

HORIZONTAL MOUNT BI-COLOR LIGHTS

1



Fig. 0615 *STEALTH* Series L.E.D. Bi-Color Light Patent Pending

Certified For Use on Power Driven Vessels
Under 12 Meters (39.4 ft.) in Length



Fig. 0615
Stainless



Fig. 0615
Black



Fig. 0615
White

CONSTRUCTION:

- Stainless Steel
- Black or White PERKO•KOTE
- Ultra Low Profile

L.E.D. Features

- Uses 10% of the Energy Draw of Standard Lights
- Low Heat & Long Life

ORDERING INFO

Finish	Dealer Pkg.	OEM	Ship Wt.
	1 Card	Bulk Pkg.	Carton Lbs.
Stainless	0615DP0STS	0615000STS	0.6/3.3
Black	0615DP0BLK	0615000BLK	0.6/3.3
White	0615DP0WHT	0615000WHT	0.6/3.3

TECH INFO

- 12 Volt
- Vertical Ht.: 1/2"
- Length: 2-1/2"
- Width: 2-5/8"
- Screw Size: #8



PROFILE VIEW

Spare gasket kit required for mounting on metallic surfaces (optional for fiberglass surfaces)
0615000GKT (included in D.P. package).

Fig. 0229 Incandescent B-Color Light Fig. 0619 L.E.D. Bi-Color Light

Certified For Use on Power Driven Vessels
Under 20 Meters (65.6 ft.) in Length



Fig. 0619



Fig. 0619
White



Fig. 0229
Chrome

CONSTRUCTION:

- Chrome Plated Bronze Top with Black Polymer Base or White PERKO•KOTE Bronze Top with White Polymer Base
- One Piece Lens/Base Assembly
- Includes Mounting Gasket

L.E.D. Version Features

- Uses 10% of the Energy Draw of Standard Lights
- Low Heat & Long Life

ORDERING INFO

Finish	Dealer Pkg.	OEM Bulk Pkg.	Pkg. Qty.	Ship Wt.
				Carton Lbs.
Chrome	0229DP0CHR	0229000CHR	5/25	5.0/22.3
Chrome L.E.D.	0619DP0CHR	0619000CHR	1/1	1.6/1.5
White L.E.D.	0619DP0WHT	0619000WHT	1/1	1.6/1.5

TECH INFO

- 12 Volt
- Vertical Ht: 7/8"
- Length: 4"
- Width: 3"
- Screw Size: #8



Fig. 0229

FIG. No. 0229 SPARE PARTS ORDERING INFORMATION

Black Base with Lens Assy (Red/Green): 0229DP0LNS.
Bulbs (2 per card): 0071DP0CLR. Base with Socket Assembly: 0229DP099A.

HORIZONTAL MOUNT BI-COLOR LIGHTS

Fig. 0227 Bi-Color Light

Certified For Use on Power Driven Vessels Under 20 Meters (65.6 ft.) in Length



1

Construction:

- Chrome Plated Zinc Alloy Top with Black Polymer Base or White PERKO•KOTE Zinc Alloy Top with White Polymer Base
- Red and Green Lenses
- 12 Volt Bulbs Included



Fig. 0227

ORDERING INFO					TECH INFO
Finish	Vertical Height Inches	Dealer Pkg. 5 Cards 1 Pc. per Card	OEM Bulk Pkg. 50 Pcs.	Ship Wt. Carton Lbs. DP/OEM Bulk	<ul style="list-style-type: none"> • 12V Bulb Included • Length: 3-1/4" • Width: 2-5/16" • Screw Size: #8
Chrome	5/8	0227DP0CHR	0227000CHR	2.0/15.1	
White	5/8	0227DP0WHT	0227000WHT	2.0/15.1	

SPARE PARTS ORDERING INFORMATION

Bulbs (2 per card): 0071DP0CLR. Lens (Red/Green): 0227DP0LNS.
 Black Base with Socket Assembly: 022700099A.
 White Base with Socket Assembly: 0227W0099A.



Note: One mile visibility light available for 0° to 20° declination mounting surfaces:0225000CHR

Fig. 0252 Bi-Color Light

Certified For Use on Power Driven Vessels Under 20 Meters (65.6 ft.) in Length



CONSTRUCTION:

- Chrome Plated Bronze Top with Black Polymer Base, All Black or White Polymer
- Red and Green Lenses
- 12 Volt Bulbs Included



Fig. 0252 Black

Fig. 0252 White

Fig. 0252 Chrome

ORDERING INFO					TECH INFO
Finish	Vertical Height Inches	Dealer Pkg. 5 Cards 1 Pc. per Card	OEM Bulk Pkg. 25 Pcs.	Ship Wt. Carton Lbs. DP/OEM Bulk	<ul style="list-style-type: none"> • 12V Bulb Included • Length: 3-1/2" • Width: 2-1/4" • Screw Size: #8
Chrome	13/16	0252MB0DP1	0252MB012V	2.0/8.2	
Black	13/16	0252BB0DP1	0252BB012V	1.3/4.2	
White	13/16	0252WB0DP1	0252WB012V	1.3/4.2	

SPARE PARTS ORDERING INFORMATION

Bulbs (2 per card): 0071DP0CLR. Lens (Red/Green): 0247DP0LNS.
 Black Base with Socket Assembly: 0114000BLK. White Base with Socket Assembly: 0114000WHT.



NOTE: The above lights meet the USCG requirements for 12-volt applications. All of the above can also be used as 24-volt A.B.Y.C. A-16 certified lights on boats built prior to 11/1/03. To use as 24-volt lights while maintaining A-16 certification, replace the bulbs provided with Cat. No. 0072DP1CLR 24-volt bulbs. Contact us for 24 volt applications on new construction.

HORIZONTAL MOUNT BI-COLOR LIGHTS

Patent No. 4,500,947

1



Figs. 1310/1161 Bi-Color Lights
 Certified For Use on Power Driven Vessels
 Under 12 Meters (39.4 ft.) in Length



Figs. 1310 & 1161

CONSTRUCTION:

- Black Polymer Base
- Fig. 1310 - Chrome Plated Zinc Alloy Top
- Fig. 1161 - Chrome Plated Bronze Top
- Red and Green Lenses
- 12 Volt Bulbs Included

ORDERING INFO					TECH INFO
Material	Vertical Height Inches	Dealer Pkg. 5 Cards 1 Pc. per Card	OEM Bulk Pkg. 50 Pcs.	Ship Wt. Carton Lbs. DP/OEM Bulk	<ul style="list-style-type: none"> • 12V Bulb Included • Length: 4" • Width: 3-1/8" • Screw Size: #8
Chrome Zinc	1	1310DPOCHR	1310000CHR	2.5/22.0	
Chrome Bronze	1	1161DPOCHR	1161000CHR	3.3/28.5	

SPARE PARTS ORDERING INFORMATION

Bulbs (2 per card): 0071DPOCLR.
 Lens Set (Red/Green): 0283DPALNS.
 Base with Socket Assembly: 0136.



Fig. 0972 Bi-Color Light

Certified For Use on Sail or Power Driven Vessels
 Under 12 Meters (39.4 ft.) in Length



Fig. 0972

CONSTRUCTION:

- Chrome Plated Brass or Stainless Steel Top
- Black Polymer Base
- Red and Green Lenses
- 12 Volt Bulbs Included

ORDERING INFO				TECH INFO
Finish	Dealer Pkg. 5 Cards 1 Pc. per Card	OEM Bulk Pkg. 25 Pcs.	Ship Wt. Carton Lbs. DP/OEM Bulk	<ul style="list-style-type: none"> • 12V Bulb Included • Vertical Ht: 7/8" • O.D. Base: 2-3/8" • Screw Size: #4
Chrome Brass	0972DPOCHR	0972000CHR	1.1/4.5	
Stainless Steel	0972DPOSTS	0972000STS	1.1/4.5	

SPARE PARTS ORDERING INFORMATION

Bulbs (2 per card): 0071DPOCLR. Base with Socket Assembly: 0135.
 Lens Set, Old Style Open Top (Red/Green): 0296DPOLNS.
 Lens Set, New Style Closed Top (Red/Green): 0297DPOLNS.

NOTE: The above lights meet the USCG requirements for 12-volt applications. All of the above can also be used as 24-volt A.B.Y.C. A-16 certified lights on boats built prior to 11/1/03. To use as 24-volt lights while maintaining A-16 certification, replace the bulbs provided with Cat. No. 0072DP1CLR 24-volt bulbs. Contact us for 24 volt applications on new construction.

HORIZONTAL MOUNT BI-COLOR LIGHTS

Patent No. 4,500,947

Fig. 0904 Bi-Color Light

Certified For Replacement Use Only on Sail or Power Driven Vessels Under 12 Meters (39.4 ft.) in Length



1

CONSTRUCTION:

- Chrome Plated Brass or Stainless Steel Top
- Black Polymer Base
- Red and Green Lenses
- 12 Volt Bulbs Included



Fig. 0904

ORDERING INFO

Finish	Vertical Height Inches	Dealer Pkg. 5 Cards 1 Pc. per Card	Ship Wt. Carton Lbs. Dealer Pkg.
Chrome Brass	7/8	0904DPOCHR	1.6
Stainless Steel	7/8	0904DPOSTS	1.6

TECH INFO

- 12V Bulb Included
- Length: 4-1/4"
- Width: 2-1/8"
- Screw Size: #4
- 1 Mile Visibility

SPARE PARTS ORDERING INFORMATION

Bulbs (2 per card): 0071DPOCLR. Lens Set (Red/Green): 0296DPOLNS.
Base with Socket Assembly: 0107.

Fig. 1218 Bi-Color Light

Certified For Replacement Use Only on Power Driven Vessels Under 12 Meters (39.4 ft.) in Length



CONSTRUCTION:

- Chrome Plated Zinc Alloy with Flag Staff Socket
- Red and Green Lenses
- 12 Volt Bulbs Included



Fig. 1218

ORDERING INFO

Vertical Height Inches	Dealer Pkg. 5 Cards 1 Pc. per Card	Ship Wt. Carton Lbs. Dealer Pkg.
1-5/8	1218DPOCHR	5.2

TECH INFO

- 12V Bulb Included
- Base Dimensions: 6-3/4" x 3-7/8"
- I.D. Socket: 3/4"
- Screw Size: #8
- 1 Mile Visibility

SPARE PARTS ORDERING INFORMATION

Bulbs (2 per card): 0071DPOCLR. Lens Set (Red/Green): 0259DPALNS.
Socket Assembly: 1218DP099A.

NOTE: All of the above can also be used as 12 or 24-volt A.B.Y.C. A-16 certified replacement lights only on boats built prior to 11/1/03. To use as 24-volt lights while maintaining A-16 certification, replace the bulbs provided with Cat. No. 0072DP1CLR 24-volt bulbs. Contact us for 24 volt applications on new construction.

REMOVABLE BI-COLOR POLE LIGHTS

1



Figs. 1616 & 1618 - *STEALTH* Series - Patent Pending Removable L.E.D. Bi-Color Pole Lights

Certified For Use on Power Driven Vessels Under 12 Meters (39.4 ft.) in Length

CONSTRUCTION:

- Stainless Steel Top
- 3/4 Inch Diameter Anodized Aluminum Tube
- Stow-A-Way Plug-in Type Pole
- Requires 2 Pin Mounting Base
- Red and Green Lenses



Fig. 1616

Fig. 1618

ORDERING INFO

	Pole Length Inches	Dealer Pkg. 1 Card 1 Pc. per Card	OEM Bulk Pkg. 10 Pcs.	Ship Wt. Carton Lbs. DP/OEM Bulk
Collar Locking	12	1616DP2BLK	1616002BLK	1.0/14.8
Collar Locking	17-3/8	1616DP3BLK	1616003BLK	1.2/15.3
Sm. Threaded	12	1618DP2BLK	1618002BLK	1.0/14.8
Sm. Threaded	17-3/8	1618DP3BLK	1618003BLK	1.2/15.3

TECH INFO

- 12 Volt
 - Pole Rake: 0°
- 1616**
Locking Collar
Fits Bases: 1045 (2-Pin) and 1047 (2-Pin)
- 1618**
Small Threaded Collar
Fits Base: 1049 (2-Pin)

Compatible Bases (2 Pin)

Fig. 1045



Fig. 1047



Fig. 1049



Bases Sold Separately For Ordering Info See Pages 44 to 46.



Figs. 1612 & 1614 Removable Bi-Color Lights

Certified For Use on Sail or Power Driven Vessels Under 12 Meters (39.4 ft.) in Length

CONSTRUCTION:

- Black or White Polymer Top and Collar with Red and Green Lenses
- 3/4 Inch Diameter Anodized Aluminum Tube
- Requires 2 Pin Mounting Base

ORDERING INFO

	Pole Length Inches	Dealer Pkg. 5 Cards 1 Pc. per Card	OEM Bulk Pkg. 50 Pcs.	Ship Wt. Carton Lbs. DP/OEM Bulk
Color Black	12	1612DP2BLK	1612002BLK	2.5/20.0
Color White	12	_____	1612002WHT	2.5/20.0
Color Black	17-3/8	1612DP3BLK	1612003BLK	3.2/21.8
Color White	17-3/8	_____	1612003WHT	3.2/21.8
Color Black	12	1614DP2BLK	1614002BLK	2.4/20.4
Color White	12	_____	1614002WHT	2.4/20.4
Color Black	17-3/8	1614DP3BLK	1614003BLK	3.6/21.8
Color White	17-3/8	_____	1614003WHT	3.6/21.8

TECH INFO

- 12V Bulb Included
 - Pole Rake: 0°
- 1612**
Locking Collar
Fits Base: 1045 (2-Pin)
- 1614**
Small Threaded Collar
Fits Base: 1049 (2-Pin)

Fig. 1612 w/Locking Collar

Fig. 1614 w/Threaded Collar

Compatible Bases (2 Pin)

SPARE PARTS ORDERING INFORMATION

Bulbs (2 per card): 0071DP0CLR. Lens Set (Red/Green): 0283DPALNS.

Fig. 1045



Fig. 1049



Bases Sold Separately For Ordering Info See Pages 44 to 46.

Patent No. 4,500,947

NOTE: Figs. 1612 & 1614 meet the USCG requirements for 12-volt applications. They can also be used as 24-volt A.B.Y.C. A-16 certified lights on boats built prior to 11/1/03. To use as 24-volt lights while maintaining A-16 certification, replace the bulbs provided with Cat. No. 0072DP1CLR 24-volt bulbs. Contact us for 24 volt applications on new construction.

REMOVABLE BI-COLOR POLE LIGHTS WITH UTILITY LIGHT

Patent No. 4,500,947

Figs. 1211 & 1212 - Certified For Use on Sail or Power Driven Vessels Under 12 Meters (39.4 ft.) in Length

Figs. 1421 & 1422 - Certified For Use on Power Driven Vessels Under 20 Meters (65.6 ft.) in Length

CONSTRUCTION:

- Black or White Polymer Top and Collar with Red and Green Lenses
- 3/4 Inch Diameter Anodized Aluminum Tube
- Deck Illuminating Utility Light
- Stow-A-Way Plug-in Type Pole
- Requires 3 Pin Mounting Base



1



Fig. 1211
0° Rake

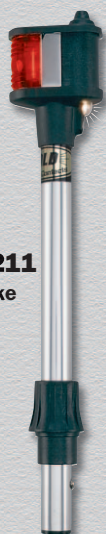

Fig. 1212
5° Rake

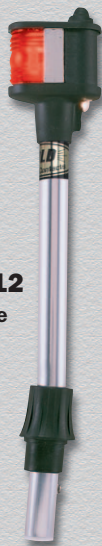

Fig. 1421
0° Rake



Fig. 1421
0° Rake

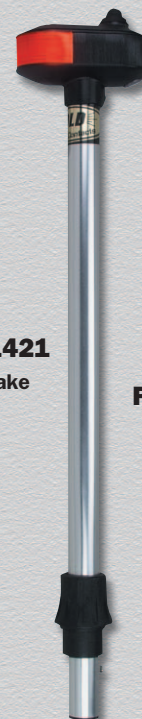

Fig. 1422
5° Rake

ORDERING INFO

Color	Pole Rake	Pole Length Inches	Dealer Pkg. 5 Cards 1 Pc. per Card	OEM Bulk Pkg. 50 Pcs.	Ship Wt. Carton Lbs. DP/OEM Bulk
Black	0°	12-1/2	1211DP2CHR	1211002CHR	2.9/23.0
White	0°	12-1/2	_____	1211002WHT	—/23.0
Black	5°	12-1/2	1212DP2CHR	1212002CHR	2.9/23.0
Black	0°	12	1421DP2CHR	1421002CHR	2.4/21.0
White	0°	12	_____	1421002WHT	—/21.0
Black	0°	17-1/4	1421DP3CHR	1421003CHR	3.0/23.5
White	0°	17-1/4	_____	1421003WHT	—/23.5
Black	5°	12	1422DP2CHR	1422002CHR	2.4/21.0

TECH INFO

- 12V Bulb Included
- Locking Collar

1211 & 1421
Pole Rake: 0°

Fits Bases: 1045 & 1047
(3-Pin)

1212 & 1422
Pole Rake: 5°

Fits Base: 1060
(3-Pin)

SPARE PARTS ORDERING INFORMATION

Bulbs (2 per card): 0071DPOCLR. Utility Light Bulb: 0064000CLR.

Lens Set Figs. 1211 & 1212 (Red/Green): 0268DPOLNS.

Lens Set Figs. 1421 & 1422 (Black Top with Welded Red/Green Lens): 0241DPOLNS.

Lens Set Fig. 1421 (White Top with Welded Red/Green Lens): 0241DPOWHT.



Compatible Bases (3 Pin)



Bases Sold Separately For Ordering Info See Pages 44 and 45

Removable bi-color lights on pages 24 and 25 are ideal for boats with casting decks on the bow. Unlike conventional bi-color lights that can stand as high as 2" above the deck, removable bi-color lights can be unplugged and stowed while fishing. This leaves only a small, flat topped base. Longer lengths are designed for use with larger trolling motors.

NAVIGATION LIGHT VERTICAL HEIGHTS

1

Combination Masthead and White All-Round Lights

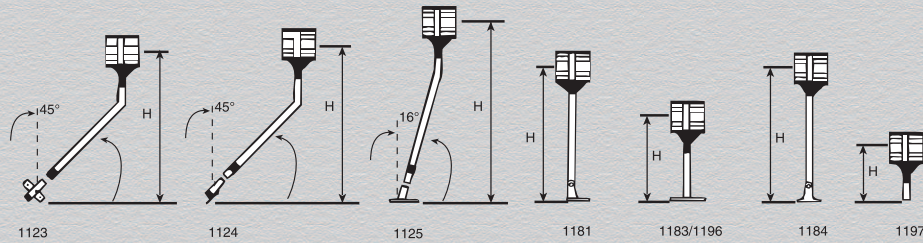

Masthead Lights

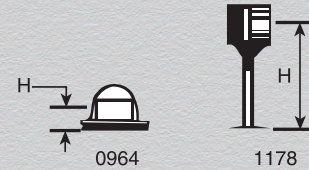

Masthead Lights		
FIG.	0964	1178
H	7/8	3-1/4

White All-Round Lights

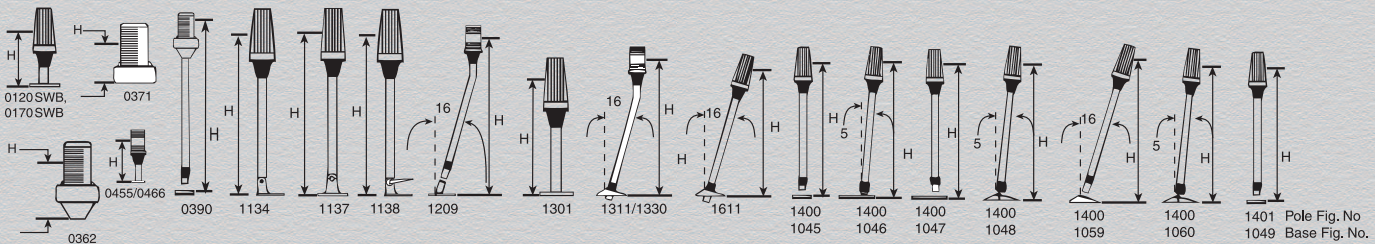

In accordance with the '72 COLREGS, navigation rules state that the center of the bulb filament of white lights must be mounted at least 1 meter (approx 40") above center of the filament of the red/green lights. The "vertical height" (H) of a light is measured from the deck of the boat to the center of the light filament. Most pole lights (all of Perko's) are sold by their "nominal (or approximate) overall length". Three factors affect the difference between overall length and vertical height. 1) The depth the pole goes into the base (typically less than two inches). 2) The distance from the filament to the top of the light (typically less than an inch). 3) Rake angle (can shorten the vertical height by as much as an inch (for bends under 16 degrees). So, as a general rule, the installed "vertical height" will be between 2 and 4 inches less than the nominal length of the pole. Select the shortest light that will insure that the requirements are met after taking this difference into account. Be sure the light is long enough to be seen over any obstructions. If this light is too long to store easily, consider a fold-in-half light for easier storage.

Dimensions										
SIZE	Base	1	2	3	4	5	6	7	8	
Pole Fig.	Fig.	H	H	H	H	H	H	H	H	H
White All-Round Lights										
0120SWB		3-7/8								
0170SWB		3-7/8								
0390	0391						48	54	60	
0362		1-1/2								
0371		1-1/2								
0455		4-1/2	11-7/8							
0466		4-1/2	11-7/8							
1134/1137		14								
1138		14								
1209		21-7/8	28-1/2	34-1/8						
1301		7-1/8								
1311			20-1/8	26-5/8	32-3/8					
1330			20-11/16	27-1/4	33					
1411			22	27-5/8	33-5/8					
1611			20-1/4	26-1/2	32-3/8					
1400	1045					40-3/4	46-7/8	51-3/4	57-3/4	
1400	1046		21-5/8	27-1/4	33-1/4	40-5/8	46-1/2	51-1/2	57-1/2	
1400	1047					40-5/8	46-7/8	51-3/4	57-3/4	
1400	1048				34	40	46	52	58	
1401	1049				33-1/4	40-3/4	46-7/8	51-3/4	57-3/4	
1400	1059		21-5/8	27-1/4	33	40-1/8	45-7/8	50-3/4	56-3/4	
1400	1060		22	27-5/8	33-5/8	41	46-7/8	51-7/8	57-7/8	
Combination Masthead and White All-Round Lights										
1123			11-1/4	20-1/2						
1124			12-1/2	22						
1125					33-7/8					
1181/1184		12-13/16								
1183		3-3/16								
1184		12-13/16								
1196		5-1/16	11-1/4							
1197		4								

All Dimensions are in inches.

Note: Vertical heights shown above are for various pole light and base combinations.

NAVIGATION LIGHT VERTICAL HEIGHTS

Bi-Color Lights

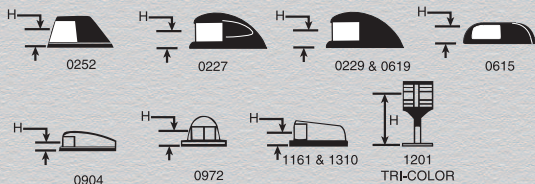

Side Lights

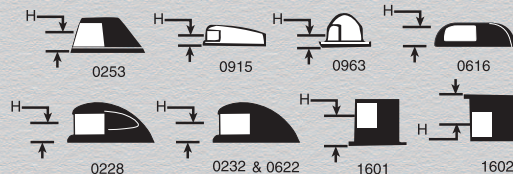

Bi-Color Lights											
FIG.	0227	0229	0252	0615	0619	0904	0972	1161	1201	1218	1310
H	5/8	7/8	13/16	1/2	7/8	7/8	7/8	1	3-1/4	1-5/8	1

Side Lights										
FIG.	0228	0232	0253	0616	0622	0915	0963	1601	1602	
H	5/8	7/8	13/16	1/2	7/8	7/8	7/8	1-1/4	1-1/4	

"REDUCED GLARE" DESIGN WHITE ALL-ROUND LIGHTS

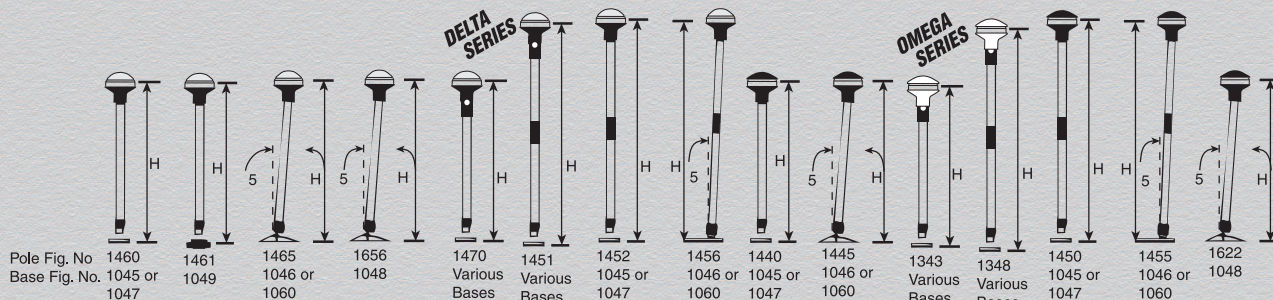

Pole Light and Base Combinations Vertical Heights						
SIZE		4	5	6	7	8
Pole Fig.	Base	H	H	H	H	H
"Reduced Glare" Design White All-Round Lights						
1343	1045	33-3/4		45-3/4		
1343	1046	33-7/8		45-7/8		
1343	1047	33-3/4		45-3/4		
1343	1048	34		46		
1343	1059	34-1/2		46-1/2		
1343	1060	34-1/8		46-1/8		
1348/1451	1045			46-5/8		58-5/8
1348/1451	1046			46-1/2		58-1/2
1348/1451	1047			46-5/8		58-5/8
1348/1451	1048			46-3/4		58-3/4
1348/1451	1059			47-1/4		59-1/4
1348/1451	1060			46-7/8		48-7/8
1440	1045	33	40-5/8	46-3/8	51-7/16	57-7/16
1440	1047	33	39	45	51	57
1441	1049	33	39	45	51	57
1445	1046	32-3/4	40-5/16	46-7/16	51-1/4	57-1/4
1445	1060	33-3/16	40-11/16	46-1/4	51-7/16	57-7/16
1450	1045				52-1/4	57-1/4
1450	1047				51-3/4	57-3/4
1452	1045				51-3/4	57-3/4
1452	1047				51-3/4	57-3/4
1455	1046				52-1/4	57-1/4
1455	1060				52-1/8	57-1/8
1456	1046				51-3/4	57-3/4
1456	1060				52-1/8	57-1/8
1460	1045	33	39	45	51	57
1460	1047	33	39	45	51	57
1465	1046	33	39	45	51	57
1465	1060	33-3/8	39-3/8	45-3/8	51-3/8	57-3/8
1461	1049	33	40-5/8	46-3/8	51-3/8	57-3/8
1470	1045	33-3/4	39-3/4	45-3/4	51-3/4	57-3/4
1470	1046	33-7/8	39-7/8	45-7/8	51-7/8	57-7/8
1470	1047	33-3/4	39-3/4	45-3/4	51-3/4	57-3/4
1470	1048	34	40	46	52	58
1470	1059	34-1/2	40-1/2	46-1/2	52-1/2	58-1/2
1470	1060	34-1/8	40-1/8	46-1/8	52-1/8	58-1/8
1622	1048	33-1/16	40-5/8	46-3/8	51-5/16	57-5/16
1656	1048	33-1/16	40-5/8	46-3/8	51-5/16	57-5/16

"Reduced Glare" Design Combination Masthead and White All-Round Lights

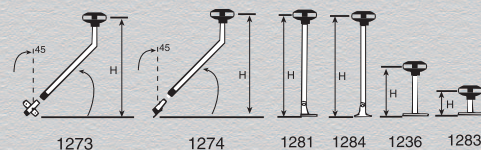

"Reduced Glare" Design Fixed Mount White All-Round Lights

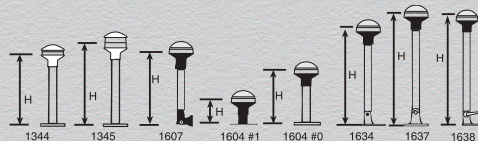

Dimensions				
SIZE	0	1	2	3
Fig. No.	H	H	H	H
"Reduced Glare" Design Fixed Mount White All-Round Lights				
1344	7-1/8			
1345	7-1/2			
1604	7-7/8	2-5/8		
1607	7-1/4			
1634/1637	13-3/8			
1638	13-3/8			
"Reduced Glare" Design Combination Masthead and White All-Round Lights				
1236		4-1/2	11	
1273			10-5/8	20
1274			11-7/8	21-5/8
1281/1284	12-3/16			
1283	2-1/4			

Note: Vertical heights shown above are for various pole light and base combinations.

All Dimensions are in inches.

NAVIGATION LIGHT VERTICAL HEIGHTS

STEALTH Series L.E.D. Bi-Color Pole Lights and White All-Round Lights Patent Pending

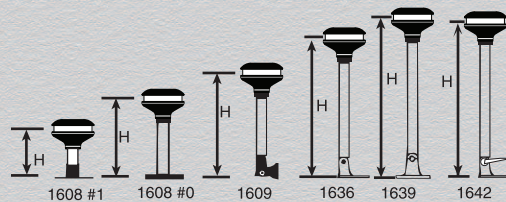
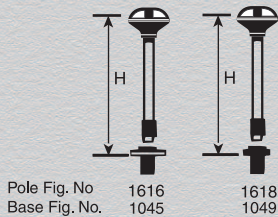

STEALTH L.E.D. Bi-Color Pole Lights						
Pole.	1616#2	1616#2	1616#3	1616#3	1618#2	1618#3
Base	1045	1047	1045	1047	1049	1049
H	10-3/8	10-3/8	15-7/8	15-7/8	10-3/8	16

Dimensions		
SIZE	0	1
Fig. No.	H	H
STEALTH		
"Reduced Glare" Design		
Fixed Mount L.E.D.		
White All-Round Lights		
1608	7-5/8	3-3/4
1609	7-3/4	
1636	13-5/8	
1639	13-3/4	
1642	13-1/4	

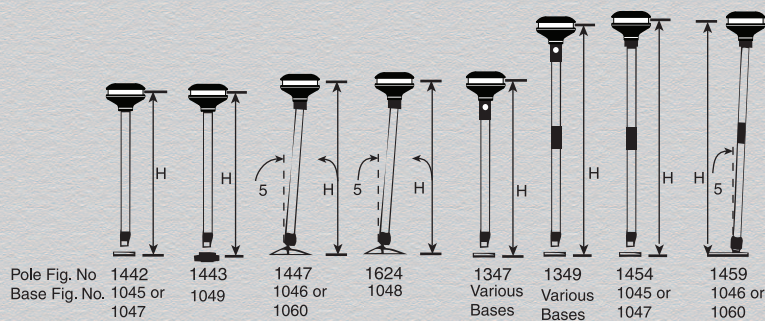

Pole Light and Base Combinations Vertical Heights								
SIZE		2	3	4	5	6	7	8
Pole Fig.	Base	H	H	H	H	H	H	H
STEALTH "Reduced Glare" Design L.E.D. White All-Round Lights								
1347	1045	21		33-3/4	41-3/8	47-1/8	52-1/8	
1347	1046	21		33-3/4	41-3/8	47-1/8	52-1/8	
1347	1047	21		33-3/4	41-3/8	47-1/8	52-1/8	
1347	1048	21-3/8		34	41-5/8	47-1/2	52-3/8	
1347	1059	21-3/4		34-5/8	42	48	52-7/8	
1347	1060	21-3/8		34-1/2	41-5/8	47-1/2	52-3/8	
1349	1045					46-1/4		59
1349	1046					46-1/4		59
1349	1047					46-1/4		59
1349	1048					46-5/8		59-3/8
1349	1059					47-1/8		59-3/4
1349	1060					46-5/8		59-3/8
1442	1045	20-1/8	26-7/8	33	40-1/2	46-3/8	51-1/4	58-1/4
1442	1047	20-1/8	26-7/8	33	40-1/2	46-3/8	51-1/4	58-1/4
1447	1046	20-1/8	26-7/8	33	40-1/2	46-3/8	51-1/4	58-1/4
1447	1060	20-1/8	27-1/8	33-1/4	40-7/8	46-5/8	51-5/8	58-5/8
1624	1048			33-1/4	40-7/8	46-5/8	51-1/2	58-1/2
1443	1049			33	40-5/8	46-3/8	51-3/8	58-3/8
1454	1045						52-1/4	58-1/8
1454	1047						52-1/4	58-1/8
1459	1046						52-1/8	58-1/8
1459	1060						52-1/2	58-1/2

Note: Vertical heights shown above are for various pole light and base combinations.

CHOOSING A REPLACEMENT POLE LIGHT

1

1. Select a Globe Style



Globes come in 3 basic types:

1. White all-round Full Output allows for full cockpit illumination. Choose traditional or modern styles.
2. White all-round Reduced Glare helps preserve night vision while under way. Choose clear top coastal or inland.
3. Bi-Color lights are used on the bow instead of a fixed surface mount light. Choose from models with or without integral white utility light.

2. Select a Rake Angle

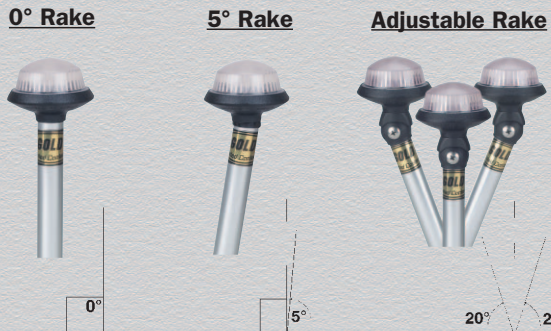

Rake is determined by the pole, base and base location angles. Rake is important for all reduced glare lights to insure that light output is correct. The most common rake angles are 0°, 5° and 16°. Custom made poles often have non-standard rake angles. Choose from 0°, 5° or fully adjustable versions (Delta, Stealth and Omega Series).

3. Determine if the Key Slot Screw Position is Important

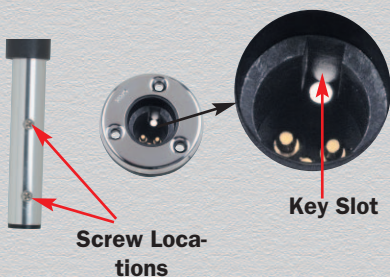

Most manufacturers insert screws into an upper or lower location on the pole to position the light and hold it properly oriented in the base. The location of this screw varies by manufacturer and model. Determine the key slot screw position needed for your base and match it to the pole you select. All Perko plug in bases accept the upper screw position and all Perko lights have an upper screw. Perko Alpha, Delta, Omega and Stealth Series replacement lights offer the option to locate the screw in either place.

4. Determine the Pole Length

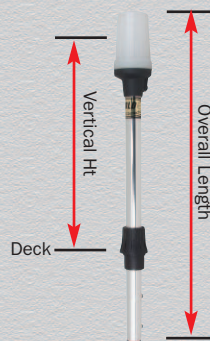

Navigation rules state that the center of the bulb filament of white lights must be mounted at least 1 meter (approx 40") above center of the filament of the red/green lights. The "vertical height" of a light is measured from the deck of the boat to the center of the light filament. Most pole lights (all of Perko's) are sold by their "nominal (or approximate) overall length". Three factors affect the difference between overall length and vertical height. 1) The depth the pole goes into the base is typically less than two inches. 2) The distance from the filament to the top of the light is typically less than an inch. 3) Rake angle can shorten the vertical height by as much as an inch (for bends under 16 degrees). So, as a general rule, the installed "vertical height" will be between 2 and 4 inches less than the nominal length of the pole. Select the shortest light that will insure that the requirements are met after taking this difference into account. Be sure the light is long enough to be seen over any obstructions. If this light is too long to store easily, consider a fold-in-half light for easier storage.

5. Decide on a Collar Type



Some manufacturers use different types of collars to assure that their pole lights are held securely in the base. All Perko lights are shipped with at least one collar (a locking collar, a large threaded collar or a small threaded collar). Determine whether a collar is needed for your base and match it by collar type to the pole you select. All Perko bases require collars.

6. Determine the Number of Pins



Bi-color lights are available with and without an integral white utility light. Those lights with a utility light require 3 contact pins. Determine if 2 or 3 contact pins are needed for your base and match it to the pole you select.

O.E.M. BULK PACKAGED WHITE ALL-ROUND POLE LIGHTS

1

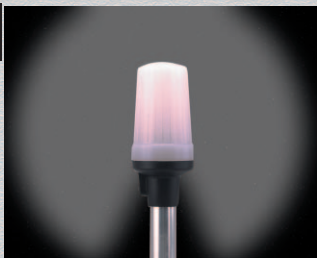

0201 Style

Traditional frosted globe allows for all round visibility even when globe orientation is not horizontally aligned. In addition, this design also provides limited cockpit illumination.

Used on

- 1400 Alpha Retail Series
- 1401 OEM Series
- 1403 & 1404 OEM Series
- 1611 Telescoping Series
- 1134 & 1137 Series Folding Lights
- OEM Specials



0248 Clear Style

Globe allows for all round visibility even when globe orientation is not horizontally aligned. In addition, this design also provides limited cockpit illumination.

Used on

- 0455 Fixed Mount Series
- 1209 Plug-In Mount Series
- 1311 & 1330 Telescoping Series
- OEM Specials

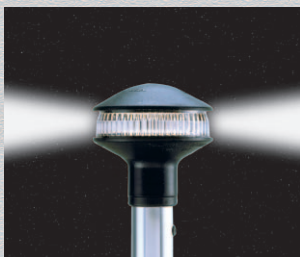

**0238 Style
Inland Series**

A reduced glare globe preserves night vision while under way. Globe must be horizontal to function properly.

Used on

- 1440 Retail & OEM Series
- 1441 OEM Series
- 1445 Retail & OEM Series
- 1450 OEM Series
- 1455 OEM Series
- 1622 OEM Series
- OEM Specials



0248 Frosted Style

Globe allows for all round visibility even when globe orientation is not horizontally aligned. In addition, this design also provides limited cockpit illumination.

Used on

- 0466 Series
- OEM Specials



**0239 Style
Coastal Series**

A reduced glare globe preserves night vision while under way. Globe must be horizontal to function properly.

Used on

- 1452 OEM Series
- 1456 OEM Series
- 1460 Retail & OEM Series
- 1461 OEM Series
- 1465 Retail & OEM Series
- 1656 OEM Series
- 1604 Fixed Mount
- 1607 Tower/Arch Mount
- 1634 & 1637 Windshield Mount Series
- OEM Specials



Delta Style

A reduced glare globe preserves night vision while under way. Adjustability of the globe allows for proper horizontal alignment no matter what base configuration.

Used on

- 1470 Delta Retail Series
- 1451 Delta Retail Series
- OEM Specials

Features

- Wide 40° Adjustable Head



STEALTH L.E.D. Style

A reduced glare globe preserves night vision while under way. Globe must be horizontal to function properly.



Used on

- 1347 & 1349 Retail Series
- 1442 & 1443 OEM Series
- 1447 OEM Series
- 1454 & 1459 OEM Series
- 1624 OEM Series
- 1636, 1369 & 1642 Series
- 1608 & 1609 Series
- OEM Specials

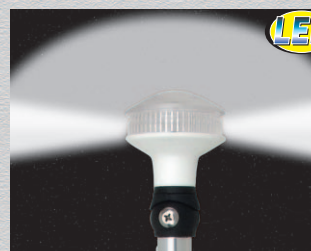

Omega L.E.D. Style

A reduced glare globe preserves night vision while under way. Adjustability of the globe allows for proper horizontal alignment no matter what base configuration.



Used on

- 1343 Omega Retail Series
- 1348 Omega Retail Series
- 1345 Series
- OEM Specials

Features

- Wide 40° Adjustable Head
- L.E.D. Light



Custom Pole Lights and Connectors

Special Custom Connectors Available



Perko manufactures a wide range of custom pole lights and pole light assemblies for OEMs and boat builders in quantities as low as 10 pieces. Customization features include lengths, bends, pole diameters, materials and colors. In addition, we can assemble non-standard combinations of bases, poles and pole light heads. Termination is also a popular customization option where we regularly install connectors made by Amp™, Delphi™, Packard™ and others. Consult the factory for quick quotes and samples of custom pole light assemblies.



RETAIL PACKAGED WHITE ALL-ROUND POLE LIGHTS

1

USCG



STEALTH Series - Universal Replacement Reduced Glare Design White All-Round Lights Patent Pending

Figs. 1347 & 1349

Certified For Use on Power Driven Vessels Under 20 Meters (65.6 ft.) in Length

NEW Item

Wide 40° Head Adjustability (± 20°)

Fig. 1347

A reduced glare globe preserves night vision while under way. Adjustability of the globe allows for proper horizontal alignment regardless of base configuration.

CONSTRUCTION:

- Black Polymer Top with Clear Fluted Lens
- 3/4 Inch Diameter Anodized Aluminum Tube
- Gold Plated Contacts
- Sealed from the Environment

STEALTH Offers:

- 2 Collars - Threaded and Locking
- 2 Screw Positions
- Wide 40° Adjustable Head
- Long Life
- Vibration Resistance
- Low Power Drain
- Improved Corrosion Resistance
- Low Operating Temperature



Fig. 1349 Fold in Half Pole

ORDERING INFO			TECH INFO
Approx. Pole Length Inches	Black Dealer Pkg. 1 Pc. per Card	Ship Wt. Carton Lbs. Dealer Pkg.	<ul style="list-style-type: none"> • Head: 40° Adjustable • L.E.D.: 12 Volt • Pole: 3/4" Dia. Anodized Locking Collar Fits Bases: 1045, 1046, 1047 1059 & 1060 (2 Pin) Large Threaded Collar Fits Base: 1048 (2 Pin)
Straight Pole			
24	1347DP2CHR	0.9	
36	1347DP4CHR	1.0	
42	1347DP5CHR	1.1	
48	1347DP6CHR	1.2	
54	1347DP7CHR	1.3	
Fold in Half Pole			
48	1349DP6CHR	1.5	
60	1349DP8CHR	1.8	

Note: **STEALTH** Series lights are designed to also fit most other manufacturers' bases.

Compatible Bases (2 Pin)

Call Us For



Bases Sold Separately For Ordering Info See Pages 44 to 46.



RETAIL PACKAGED WHITE ALL-ROUND POLE LIGHTS

Omega Series - Universal Replacement

Reduced Glare Design - Figs. 1343 & 1348

Certified For Use on Power Driven Vessels Under 20 Meters (65.6 ft.) in Length



1

A reduced glare globe preserves night vision while under way. Adjustability of the globe allows for proper horizontal alignment regardless of base configuration.

Omega's L.E.D. Light Source Takes the Delta Design One Step Further

CONSTRUCTION:

- White Polymer Top with Clear Fluted Lens
- 3/4 Inch Diameter Anodized Aluminum Tube
- Gold Plated Contacts
- Sealed from the Environment

Omega Offers:

- 2 Collars - Threaded and Locking
- 2 Screw Positions
- Wide 40° Adjustable Head
- Long Life
- Vibration Resistance
- Low Power Drain
- Improved Corrosion Resistance
- Low Operating Temperature

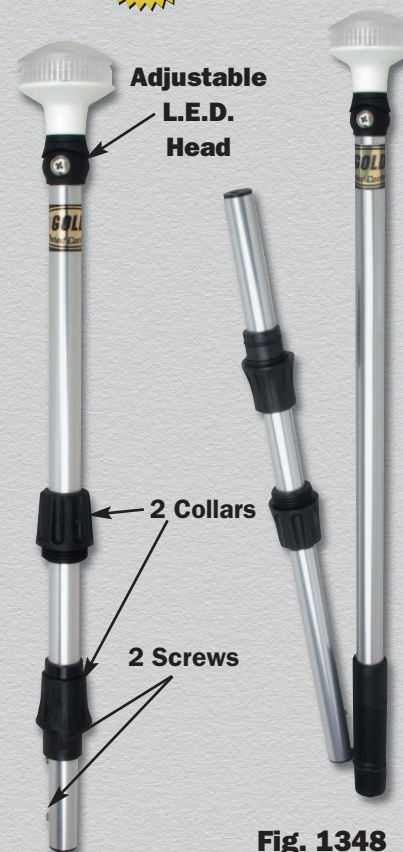

Fig. 1343

Fig. 1348
Fold in Half Pole

ORDERING INFO			TECH INFO
Approx. Pole Length Inches	Dealer Pkg. 1 Pc. per Card	Ship Wt. Carton Lbs. Dealer Pkg.	Head: 40° Adjustable L.E.D.: 12 Volt Pole: 3/4" Dia. Anodized
Straight Pole			Locking Collar Fits Bases: 1045, 1046, 1047, 1059 & 1060 (2 Pin)
36	1343DP4CHR	2.1	Large Threaded Collar Fits Base: 1048 (2 Pin)
48	1343DP6CHR	2.3	
Fold in Half Pole			Note: Omega Series lights are designed to also fit most other manufacturers' bases.
48	1348DP6CHR	2.5	Wide 40° Adjustability (± 20°)
60	1348DP8CHR	2.8	



Compatible Bases (2 Pin)



Bases Sold Separately For Ordering Info See Pages 44 to 46.



RETAIL PACKAGED WHITE ALL-ROUND POLE LIGHTS

1

USCG

2
nm



Gold Plated Contacts

Full Output Globe

Wide 40° Head Adjustability (± 20°)

2 Collars

2 Screws



Fig. 1451
Fold in Half Pole

Fig. 1470

Note: Delta Series lights are designed to also fit most other manufacturers' bases.



Wide 40° Adjustability (± 20°)

Delta Series - Universal Replacement

Reduced Glare Design - Figs. 1451 & 1470

Certified For Use on Power Driven Vessels Under 20 Meters (65.6 ft.) in Length

A reduced glare globe preserves night vision while under way. Adjustability of the globe allows for proper horizontal alignment regardless of base configuration.

Delta's Combination of Features put it in a Class by Itself
No Other Pole Light System Offers More

CONSTRUCTION:

- Black Polymer Top with Clear Fluted Lens
- 3/4 Inch Diameter Anodized Aluminum Tube
- Gold Plated Contacts

Delta Offers:

- 2 Globes - Reduced Glare and Full Output
- 2 Collars - Threaded and Locking
 - 2 Screw Positions
- Wide 40° Adjustable Head



ORDERING INFO

Approx. Pole Length Inches	Dealer Pkg. 1 Pc. per Card	Dealer Pkg. Cards per Package	Ship Wt. Carton Lbs. Dealer Pkg.
Straight Pole			
24	1470DP2CHR	10	8.0
36	1470DP4CHR	10	9.2
42	1470DP5CHR	10	10.5
48	1470DP6CHR	5	6.1
54	1470DP7CHR	5	6.4
60	1470DP8CHR	5	6.6
Fold in Half Pole			
48	1451DP6CHR	5	6.7
60	1451DP8CHR	5	7.3

TECH INFO

- Head: 40° Adjustable
 - Bulb: 12 Volt (Included)
 - Pole: 3/4" Dia. Anodized
- Collar: Locking
Fits Bases: 1045, 1046, 1047, 1059 & 1060 (2 Pin)
- Large Threaded Collar
Fits Base: 1048 (2 Pin)

SPARE PARTS ORDERING INFORMATION

Bulbs: (2 per card): 0338DP2CLR Clear Globe: 0239DP0CLR
Black/Clear Globe: 0239DP0BLK.

Compatible Bases (2-Pin)

Bases Sold Separately For Ordering Info See Pages 44 to 46.



RETAIL PACKAGED WHITE ALL-ROUND POLE LIGHTS

Alpha Series - Universal Replacement

White All-Round Light Fig. 1400

Certified For Use on Sail or Power Driven Vessels Under 20 Meters (65.6 ft.) in Length



1

Traditional frosted globe allows for all round visibility even when globe orientation is not horizontally aligned. In addition, this design also provides limited cockpit illumination.

CONSTRUCTION:

- Replacement Stow-A-Way Plug-In Type
- Black Polymer Top with White Translucent Globe
- Selective Use of 2 Screw Holes and/or Collar Allow for Use in Multiple Applications



Fig. 1400



2 Collars

2 Screws

Note: Fig. 1400 is designed to also fit most other manufacturers' bases.

ORDERING INFO

Pole Length Inches	Dealer Pkg. 1 Pc. per Card 10 Cards per Pkg.	Ship Wt. Carton Lbs. Dealer Pkg.
24	1400DP2CHR	7.0
30	1400DP3CHR	7.5
36	1400DP4CHR	8.0
42	1400DP5CHR	8.5
48	1400DP6CHR	9.0
54	1400DP7CHR	9.5
60	1400DP8CHR	10.0

TECH INFO

- Pole Rake: 0°
- Bulb: 12 Volt (Included)
- Pole: 3/4" Dia. Anodized

Locking Collar
Fits Bases:
**1045, 1046, 1047,
1059
& 1060 (2 Pin)**

Large Threaded Collar
Fits Base: **1048 (2 Pin)**

SPARE PARTS ORDERING INFORMATION

Bulbs (2 per card): 0337012DP. White Translucent Globe: 0201DPOWHT.

Compatible Bases (2-Pin)

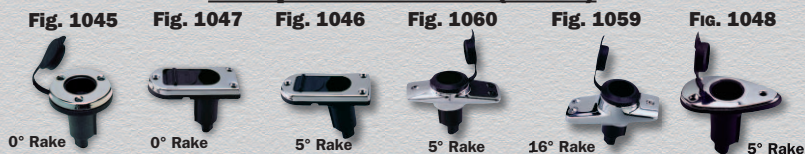

Bases Sold Separately
For Ordering Info
See Pages 44 to 46.

O.E.M. BULK PACKAGED WHITE ALL-ROUND POLE LIGHTS

1

USCG



STEALTH L.E.D. Series Reduced Glare Design Patent Pending

These Lights are Certified For Use on Power Driven Vessels Under 20 Meters (65.6 ft.) in Length.

The "Reduced Glare" design helps preserve night vision by reducing the amount of light wasted outside of the visibility zone and not attracting as many bugs.

CONSTRUCTION:

- Stow-A-Way Plug-in Pole
- Clear Fluted Lens
- Black Polymer Top and collars
- Contemporary Styling



1442/1447 SERIES ORDERING INFO			
	Approx. Length Inches	OEM Bulk Pkg. 10 Pcs.	Ship Wt. Carton Lbs. OEM Bulk Pkg.
Fig. 1442 Locking Collar 0° Rake	24	1442002CHR	6.0
	30	1442003CHR	7.0
	36	1442004CHR	8.0
	42	1442005CHR	9.0
	48	1442006CHR	10.0
	54	1442007CHR*	11.0
Fig. 1447 Locking Collar 5° Rake	60	1442008CHR*	12.0
	24	1447002CHR	6.0
	30	1447003CHR	7.0
	36	1447004CHR	8.0
	42	1447005CHR	9.0
	48	1447006CHR	10.0
	54	1447007CHR*	11.0
	60	1447008CHR*	12.0

TECH INFO
<ul style="list-style-type: none"> • Locking Collar • L.E.D.: 12 Volt • Pole: 3/4" Dia. Anodized
<p>1442 Pole Rake: 0° Fits Bases: 1045 & 1047 (2 Pin)</p>
<p>1447 Pole Rake: 5° Fits Bases: 1046 & 1060 (2 Pin)</p>

*Note: For Fold in Half versions of 1442 & 1447 poles, see Figs. 1454 & 1459 on page 39.

1624 SERIES ORDERING INFO			
	Approx. Length Inches	OEM Bulk Pkg. 10 Pcs.	Ship Wt. Carton Lbs. OEM Bulk Pkg.
Fig. 1624 Large Threaded Collar 5° Rake	36	1624004CHR	8.0
	42	1624005CHR	9.0
	48	1624006CHR	10.0
	54	1624007CHR	11.0
	60	1624008CHR	12.0

TECH INFO
<ul style="list-style-type: none"> • Large Threaded Collar • L.E.D.: 12 Volt • Pole: 3/4" Dia. Anodized
<p>Pole Rake: 5° Fits Base: 1048 (2 Pin)</p>

1443 SERIES ORDERING INFO			
	Approx. Length Inches	OEM Bulk Pkg. 10 Pcs.	Ship Wt. Carton Lbs. OEM Bulk Pkg.
Fig. 1443 Small Threaded Collar 0° Rake	36	1443004CHR	8.0
	42	1443005CHR	9.0
	48	1443006CHR	10.0
	54	1443007CHR	11.0
	60	1443008CHR	12.0

TECH INFO
<ul style="list-style-type: none"> • Small Threaded Collar • L.E.D.: 12 Volt • Pole: 3/4" Dia. Anodized
<p>Pole Rake: 0° Fits Base: 1049 (2 Pin)</p>

Call Us For



Bases Sold Separately For Ordering Info See Pages 44 to 46.

Compatible Bases (2-Pin)



O.E.M. BULK PACKAGED WHITE ALL-ROUND POLE LIGHTS

Reduced Glare Design - Coastal Series

These Lights are Certified For Use on Power Driven Vessels

Under 20 Meters (65.6 ft.) in Length.

The Clear Globe allows for improved visibility when in rough water and from above.

Advanced globe design reduces glare and helps preserve night vision.



CONSTRUCTION:

- Stow-A-Way Plug-in Pole
- Clear Fluted Globe with Frosted Top
- Black Polymer
- Contemporary Styling

1460/1465 SERIES ORDERING INFO

	Approx. Length Inches	OEM Bulk Pkg. 50 Pcs.	Ship Wt. Carton Lbs. OEM Bulk Pkg.
Fig. 1460 Locking Collar 0° Rake	24	1460002CHR	23.0
	30	1460003CHR	26.5
	36	1460004CHR	28.5
	42	1460005CHR	35.0
	48	1460006CHR	42.5
	54	1460007CHR*	44.0
Fig. 1465 Locking Collar 5° Rake	60	1460008CHR*	46.0
	24	1465002CHR	23.0
	30	1465003CHR	26.5
	36	1465004CHR	28.5
	42	1465005CHR	35.0
	48	1465006CHR	42.5
54	1465007CHR*	44.0	
60	1465008CHR*	46.0	

TECH INFO

- Bulb: 12 Volt (Included)
- Locking Collar Pole: 3/4" Dia. Anodized

1460

- Pole Rake: 0°
- Fits Bases: 1045 & 1047 (2 Pin)**

1465

- Pole Rake: 5°
- Fits Bases: 1046 & 1060 (2 Pin)**



*Note: For Fold in Half versions of 1460 & 1465 poles, see Figs. 1452 & 1456 on page 39.

1656 SERIES ORDERING INFO

	Approx. Length Inches	OEM Bulk Pkg. 50 Pcs.	Ship Wt. Carton Lbs. OEM Bulk Pkg.
Fig. 1656 Large Threaded Collar 5° Rake	36	1656004CHR	28.5
	42	1656005CHR	37.5
	48	1656006CHR	40.5
	54	1656007CHR	43.5
	60	1656008CHR	45.0

TECH INFO

- Large Threaded Collar
- Bulb: 12 Volt (Included)
- Pole: 3/4" Dia. Anodized
- Pole Rake: 5°

Fits Base: 1048 (2Pin)



1461 SERIES ORDERING INFO

	Approx. Length Inches	OEM Bulk Pkg. 50 Pcs.	Ship Wt. Carton Lbs. OEM Bulk Pkg.
Fig. 1461 Small Threaded Collar 0° Rake	36	1461004CHR	28.5
	42	1461005CHR	37.5
	48	1461006CHR	40.5
	54	1461007CHR	43.5
	60	1461008CHR	45.0

TECH INFO

- Small Threaded Collar
- Bulb: 12 Volt (Included)
- Pole: 3/4" Dia. Anodized
- Pole Rake: 0°

Fits Base: 1049 (2 Pin)



SPARE PARTS ORDERING INFORMATION

Bulbs For Lights on this Page (2 per card): 0338DP2CLR.
Lens Assembly: 0239DPOBLK.

Compatible Bases (2-Pin)

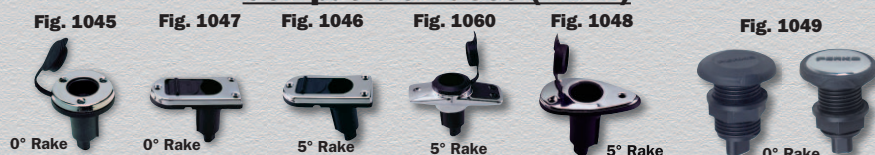

Bases Sold Separately
For Ordering Info
See Pages 44 to 46.



O.E.M. BULK PACKAGED WHITE ALL-ROUND POLE LIGHTS

1

Reduced Glare Design - Inland Series

These Lights are Certified For Use on Power Driven Vessels Under 20 Meters (65.6 ft.) in Length
The original "Reduced Glare" light, this design helps preserve night vision. In addition, since the amount of light wasted outside of the visibility zone is greatly reduced, this light does not attract as many bugs.



CONSTRUCTION:

- Stow-A-Way Plug-in Pole
- Clear Fluted Globe
- Black Polymer Top and Collars
- Contemporary Styling



1440/1445 SERIES ORDERING INFO			
	Approx. Length Inches	OEM Bulk Pkg. 50 Pcs.	Ship Wt. Carton Lbs. OEM Bulk Pkg.
Fig. 1440 Locking Collar 0° Rake	24	1440002CHR	23.0
	30	1440003CHR	26.5
	36	1440004CHR	34.0
	42	1440005CHR	32.0
	48	1440006CHR	32.0
	54	1440007CHR*	34.5
Fig. 1445 Locking Collar 5° Rake	60	1440008CHR*	45.0
	24	1445002CHR	23.0
	30	1445003CHR	26.5
	36	1445004CHR	30.0
	42	1445005CHR	32.0
	48	1445006CHR	32.0
	54	1445007CHR*	34.5
	60	1445008CHR*	45.0

TECH INFO
<ul style="list-style-type: none"> • Locking Collar • Bulb: 12 Volt (Included) • Pole: 3/4" Dia. Anodized
<p>1440 Pole Rake: 0° Fits Bases: 1045 & 1047 (2 Pin)</p>
<p>1445 Pole Rake: 5° Fits Bases: 1046 & 1060 (2 Pin)</p>

*Note: For Fold in Half versions of 1440 & 1445 poles, see Figs. 1450 & 1455 on page 39.



1622 SERIES ORDERING INFO			
	Approx. Length Inches	OEM Bulk Pkg. 50 Pcs.	Ship Wt. Carton Lbs. OEM Bulk Pkg.
Fig. 1622 Large Threaded Collar 5° Rake	36	1622004CHR	30.0
	42	1622005CHR	31.0
	48	1622006CHR	34.0
	54	1622007CHR	34.5
	60	1622008CHR	45.0

TECH INFO
<ul style="list-style-type: none"> • Large Threaded Collar • Bulb: 12 Volt (Included) • Pole: 3/4" Dia. Anodized • Pole Rake: 5°
Fits Base: 1048 (2 Pin)

1441 SERIES ORDERING INFO			
	Approx. Length Inches	OEM Bulk Pkg. 50 Pcs.	Ship Wt. Carton Lbs. OEM Bulk Pkg.
Fig. 1441 Small Threaded Collar 0° Rake	36	1441004CHR	28.5
	42	1441005CHR	31.0
	48	1441006CHR	34.0
	54	1441007CHR	4.5
	60	1441008CHR	42.0

TECH INFO
<ul style="list-style-type: none"> • Small Threaded Collar • Bulb: 12 Volt (Included) • Pole: 3/4" Dia. Anodized • Pole Rake: 0°
Fits Base: 1049 (2 Pin)

SPARE PARTS ORDERING INFORMATION

Bulbs (2 per card): 0338DP2CLR.
Globe: 0238DP0BLK.



Bases Sold Separately
For Ordering Info
See Pages 44 to 46.

Compatible Bases (2-Pin)



O.E.M. BULK PACKAGED FOLD IN HALF WHITE ALL-ROUND POLE LIGHTS

Certified For Use on Power Driven Vessels Under 20 Meters (65.6 ft.) in Length

USCG

1



Figs. 1454 & 1459 - *STEALTH* Series L.E.D. Reduced Glare Design Patent Pending - Fold in Half White All Round Pole Lights

1454/1459 SERIES ORDERING INFO

Approx. Length Inches	OEM Bulk Pkg. 10 Pcs.	Ship Wt. Carton Lbs. OEM Bulk Pkg.
54	1454007CHR	11.5
60	1454008CHR	12.5
54	1459007CHR	11.5
60	1459008CHR	12.5

TECH INFO

- Locking Collar
 - L.E.D.: 12 Volt
 - Pole: 3/4" Dia. Anodized
- 1454**
Pole Rake: 0°
Fits Bases:
1045 & 1047 (2 Pin)
- 1459**
Pole Rake: 5°
Fits Bases:
1046 & 1060 (2 Pin)



Fig. 1454
Locking Collar
0° Rake

Fig. 1459
Locking Collar
5° Rake



Figs. 1450 & 1455 Reduced Glare Design - Inland Series Fold in Half White All Round Pole Lights

1450/1455 SERIES ORDERING INFO

Approx. Length Inches	OEM Bulk Pkg. 50 Pcs.	Ship Wt. Carton Lbs. OEM Bulk Pkg.
54	1450007CHR	42.0
60	1450008CHR	55.0
54	1455007CHR	42.0
60	1455008CHR	55.0

TECH INFO

- Locking Collar
 - Bulb: 12 Volt (Included)
 - Pole: 3/4" Dia. Anodized
- 1450**
Pole Rake: 0°
Fits Bases:
1045 & 1047 (2 Pin)
- 1455**
Pole Rake: 5°
Fits Bases:
1046 & 1060 (2 Pin)

SPARE PARTS ORDERING INFORMATION

Bulbs (2 per card): 0338DP2CLR.
Globe: 0238DP0BLK.

Fig. 1450
Locking Collar
0° Rake

Fig. 1455
Locking Collar
5° Rake



Figs. 1452 & 1456* Reduced Glare Design - Coastal Series Fold in Half White All Round Pole Lights

1452/1456 SERIES ORDERING INFO

Approx. Length Inches	OEM Bulk Pkg. 50 Pcs.	Ship Wt. Carton Lbs. OEM Bulk Pkg.
54	1452007CHR	50.0
60	1452008CHR	62.0
54	1456007CHR	50.0
60	1456008CHR	62.0

TECH INFO

- Locking Collar
 - Bulb: 12 Volt (Included)
 - Pole: 3/4" Dia. Anodized
- 1452**
Pole Rake: 0°
Fits Bases:
1045 & 1047 (2 Pin)
- 1456**
Pole Rake: 5°
Fits Bases:
1046 & 1060 (2 Pin)

SPARE PARTS ORDERING INFORMATION

Bulbs (2 per card): 0338DP2CLR.
Globe: 0239DP0BLK.

Fig. 1452
Locking Collar
0° Rake

Fig. 1456
Locking Collar
5° Rake



Note: For the non-folding versions of pole lights on this page, see pages 36 - 38.

Compatible Bases (2-Pin)

Fig. 1045 Fig. 1047 Fig. 1046 Fig. 1060

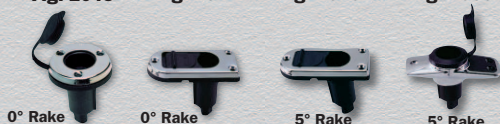

Bases Sold Separately
For Ordering Info
See Pages 44 to 46.



Call Us For



O.E.M. BULK PACKAGED WHITE ALL-ROUND POLE LIGHTS

1

USCG



Figs. 1401, 1403 & 1404 Series White All Round Lights

Certified For Use on Sail or Power Driven Vessels
Under 20 Meters (65.6 ft.) in Length

Traditional frosted globe allows for all round visibility even when globe orientation is not horizontally aligned. In addition, this design also provides limited cockpit illumination.

CONSTRUCTION:

- Replacement Stow-A-Way Plug-In Type
- Black Polymer Top with White Translucent Globe
- Black Polymer Collar



1401, 1403 & 1404 SERIES ORDERING INFO

	Pole Length Inches	OEM Bulk Pkg. 50 Pcs.	Ship Wt. Carton Lbs. OEM Bulk Pkg.
Fig. 1401 Small Thread Collar	24	1401002CHR	24.0
	30	1401003CHR	29.5
	36	1401004CHR	31.0
	42	1401005CHR	31.5
	48	1401006CHR	35.0
	54	1401007CHR	37.5
Fig. 1403 Large Thread Collar	60	1401008CHR	44.0
	24	1403002CHR	24.0
	30	1403003CHR	29.5
	36	1403004CHR	31.0
	42	1403005CHR	31.5
	48	1403006CHR	35.0
Fig. 1404 Locking Collar	54	1403007CHR	37.5
	60	1403008CHR	44.0
	24	1404002CHR	24.0
	30	1404003CHR	29.5
	36	1404004CHR	31.0
	42	1404005CHR	31.5
	48	1404006CHR	35.0
	54	1404007CHR	37.5
	60	1404008CHR	44.0

TECH INFO

- Pole Rake: 0°
- Bulb: 12 Volt (Included)
- Pole: 3/4" Dia. Anodized

1401(1 Screw Hole)
Small Threaded Collar
Fits Base: 1049 (2 Pin)

1403(2 Screw Holes)
Large Threaded Collar
Fits Base: 1048 (2 Pin)

1404(2 Screw Holes)
Locking Collar
**Fits Bases: 1045, 1046,
1047, 1059 & 1060
(2 Pin)**

SPARE PARTS ORDERING INFORMATION

Bulbs (2 per card): 0337012DP. White Translucent Globe: 0201DPOWHT.



Compatible Bases (2-Pin)

Call Us For



Bases Sold Separately
For Ordering Info
See Pages 44 to 47



WHITE ALL-ROUND POLE LIGHT & BASE COMBINATIONS

Certified For Use on Power Driven Vessels Under 20 Meters (65.6 ft.) in Length



1

Fig. 1209 - Stow-A-Way Plug-In Type Pole

- Clear Fresnel Globe
- Chrome Plated Brass Top and Base
- Screw on Polymer Collar
- Waterproof Cap and Retainer
- Mounting Base Included

Fig. 1311 - Telescoping Type Pole

- Clear Fresnel Globe with Black Polymer Top
- Chrome Plated Zinc Alloy Base
- Locking Collar on Pole
- Mounting Base Included

Fig. 1330 - Stow-A-Way Plug-In Type Pole

- Clear Fresnel Globe with Black Polymer Top
- Chrome Plated Zinc Alloy Base
- Locking Collar on Pole
- Waterproof Cover For Base
- Mounting Base Included

Fig. 1611- Telescoping Type Pole

- White Translucent Globe with Black Polymer Top
- Chrome Plated Zinc Alloy Base
- Locking Collar on Pole
- Mounting Base Included



Fig. 1209
16° Rake
Plug-In

Gold
Plated
Contacts

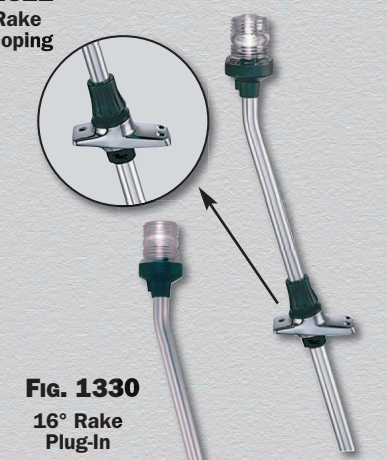

Fig. 1311
16° Rake
Telescoping

Gold
Plated
Contacts



Fig. 1330
16° Rake
Plug-In

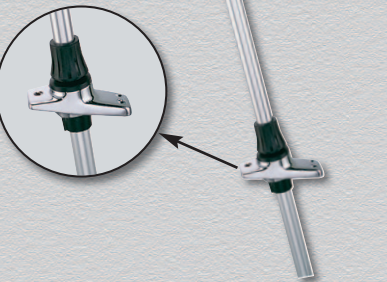

Fig. 1611
16° Rake
Telescoping

ORDERING INFO				TECH INFO
Vertical Height Inches	Dealer Pkg. 5 Cards 1 Pc. per Card	OEM Bulk Pkg. 50 Pcs.	Ship Wt. Carton Lbs. DP/OEM Bulk	
Fig. 1209				<ul style="list-style-type: none"> • Bulb: 12 Volt (Included) • Pole: 3/4" Dia. Anodized • Screw Size: #8 <p>Base Dimensions:</p> <p>1209: 3-3/8" x 2-1/4"</p> <p>1311: 3-3/4" x 1-5/8"</p> <p>1330: 3-3/4" x 1-5/8"</p> <p>1611: 3-3/4" x 1-5/8"</p>
21-7/8	1209DP2CHR	1209002CHR	6.6/41.0	
28-1/2	1209DP3CHR	1209003CHR	7.3/44.0	
34-1/8	1209DP4CHR	1209004CHR	8.0/46.0	
Fig. 1311				
20-1/8	1311DP2CHR	1311002CHR	5.5/27.0	
26-5/8	1311DP3CHR	1311003CHR	6.2/32.0	
32-3/8	1311DP4CHR	1311004CHR	6.6/38.0	
Fig. 1330				
20-11/16	1330DP2CHR	1330002CHR	5.6/27.0	
27-1/4	1330DP3CHR	1330003CHR	6.4/32.0	
33	1330DP4CHR	1330004CHR	6.6/38.0	
Fig. 1611				
20-1/4	1611DP2CHR	1611002CHR	5.1/26.0	
26-1/2	1611DP3CHR	1611003CHR	6.1/33.0	
32-3/8	1611DP4CHR	1611004CHR	6.3/34.0	

SPARE PARTS ORDERING INFORMATION

- Fig. 1209 Bulb Socket: 0024DP2.
- Fig. 1209 Cap for Base: 0125DP0BLK.
- Globe for Figs. 1209, 1311, & 1330: 0248DPOCLR.
- Globe for Fig 1611: 0201DPOWHT.
- Bulbs for Figs. 1209, 1311, & 1330, (2 per card): 0337011DP.
- Bulbs For Fig. 1611 (2 per card): 0337012DP.
- Base for Fig. 1330 1059P00DP.
- Bases for Fig. 1311 and 1611: 1059T00DP, For Fig. 1209: 1209DP099A

- Fig. 1209: Pole Only Size No. 2: 1209DP299A.
- Fig. 1209: Pole Only Size No. 3: 1209DP399A.
- Fig. 1209: Pole Only Size No. 4: 1209DP499A.
- Fig. 1330: Pole Only Size No. 2: 1330DP299A.
- Fig. 1330: Pole Only Size No. 3: 1330DP399A.
- Fig. 1330: Pole Only Size No. 4: 1330DP499A.

MARINIUM® THE MARINE ALLOY

1



In the early 1960's, a new alloy appeared. First used on large racing sailboats, the new material's high strength to weight ratio, coupled with superb corrosion resistance, made it an attractive alloy for use on boats. The new alloy was trademarked with the name Marinium® shortly after its introduction to the marine market and quickly evolved into a popular line of power boat deck hardware. The line included cleats, chocks, hinges, deck fills, rod holders and navigation lights.

For many years Marinium® was the choice material for numerous quality boat builders. But with the technology that existed in the 1970's and 1980's, Marinium® proved to be a difficult alloy to manufacture. Internal rejection rates were high. Attempts to reduce costs only compounded the rework problem. Eventually, in the early 1990's, production of Marinium® marine hardware and lights ended. The industry lost access to perhaps the greatest marine alloy ever...until now!

Using modern technology and casting techniques unavailable to manufacturers decades ago, Marinium® has finally been perfected. The high strength to weight ratios and unparalleled corrosion resistance sought after for decades by quality builders is again available, this time with Perko® reliability and quality.

- **Corrosion Resistance** - Equal to or better than any common marine alloy.
- **Strength/Weight Ratio** - Highest of any common marine alloy.
- **Weight** - Approximately 1/3 rd the weight of most marine grade alloys.
- **Finish** - Satin "Marinized" and Chrome Plated.
- **Broad Product Families** - Virtually anything we make in bronze can be made in Marinium.

Look for the Marinium Logo throughout the Catalog
or Contact the Factory for more information on the Marinium Product Line.

Fig. 0390 Heavy Duty White All-Round Pole Light

Certified For Use on Power Driven Vessels Under 20 Meters (65.6 ft.) in Length



CONSTRUCTION POLE:

- Marinium Alloy Top with Clear Fresnel Globe
- 7/8 Inch Diameter Anodized Aluminum Tube
- Requires 2 Pin Mounting Base

Actual Sizes



Traditional
3/4" Dia. Pole

New 33% Thicker Wall
Marinium System
7/8" Pole

**Fits 7/8"
Dia. Poles**

Fig. 0391 Heavy Duty Pole Light Base

CONSTRUCTION BASE:

- Marinium Alloy
- Marinium Alloy Cap with Black Rubber Gasket and Retainer



Fig. 0391



Fig. 0390

ORDERING INFO			
Pole Length Inches	Dealer Pkg. 5 Cards 1 Pc. per Card	OEM Bulk Pkg. 10 Pcs.	Ship Wt. Carton Lbs. DP/OEM Bulk
48	0390DP6MAR	0390006MAR	2.5/5.0
54	0390DP7MAR	0390007MAR	3.0/6.0
60	0390DP8MAR	0390008MAR	3.5/7.0
Base	0391DP0MAR	0391000MAR	1.4/3.0

TECH INFO
• 12 Volt
Fig. 0390
Threaded Collar
Fits Base: 0391 (2-Pin)
Fig 0391 Base
• O.D. Base: 2-3/8"
• Screw Size: #8
• Pole Rake: 0°

Cap, Retainer and Gasket for Fig 0391 Base: 0391DP099A.

7/8 INCH MARINIUM FOLDING WHITE ALL-ROUND POLE LIGHTS AND MOUNTING BASES

1



Fig. 0394 - Horizontal Mount Heavy Duty Folding Pole Light and Mounting Base

Certified For Use on Power Driven Vessels Under 20 Meters (65.6 ft.) in Length

CONSTRUCTION:

- Black Polymer Top with Clear Fluted Lens & Frosted Globe
- 7/8" Diameter Heavy Duty Aluminum Pole Rotates 90° in Both Directions
- Includes Fig. 0477 Pole Clip
- Marinium Alloy Base & Rubber Gasket
- Available Anodized Aluminum or White PERKO•KOTE Finish

Custom Pole and Head Configurations Available

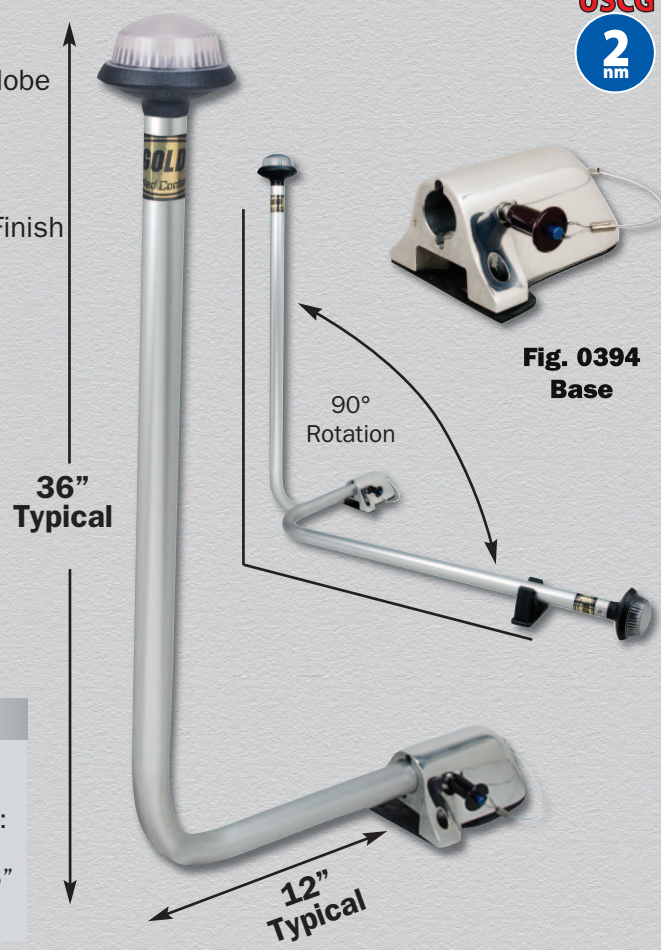

Fig. 0394 Base

ORDERING INFO			TECH INFO
Vertical Height Inches	OEM Bulk Pkg. 1 Pc.	Ship Wt. Carton Lbs. OEM Bulk	<ul style="list-style-type: none"> • 12 Volt • Pole Rake: 0° • Base Dimensions: 3-1/16" x 4-1/2" • Projection: 2-3/16" • Screw Size: #10
36	0394000MAR	1.6	

Fig. 0392 Vertical Mount Heavy Duty Pole Light Base

Fig. 0393 Vertical Mount Heavy Duty Pole Light Base

For use with 7/8" Dia. Heavy Duty Pole Lights with Threaded Collar

Construction:

- Marinium Alloy
- Marinium Alloy Cap with Black Rubber Gasket and Retainer

Fits 7/8" Dia. Poles



Fig. 0393

Fig. 0392

ORDERING INFO			TECH INFO
Projection Inches	OEM Bulk Pkg. 1 Pc.	Ship Wt. Carton Lbs. OEM Bulk	<ul style="list-style-type: none"> • 12 Volt • Pole Rake: 0° • Screw Size: #10
2-3/16	0392000MAR	1.6	<ul style="list-style-type: none"> • Fig. 0392 Base Dimensions: 3-1/16" x 3-3/8"
2-3/16	0393000MAR	1.6	<ul style="list-style-type: none"> • Fig. 0393 Base Dimensions: 3-1/16" x 4-1/2"

Cap, Retainer and Gasket for Figs 0392/0393 Base: 0392DP099A.

LOCKING COLLAR POLE LIGHT MOUNTING BASES

1



Fig. 1045 (2 Pin)
Fig. 1045 (3 Pin)
0° Rake

Fig. 1045 (2 Pin) and (3 Pin) - Plug-In Type Bases

CONSTRUCTION:

- Chrome Plated Brass or Stainless Steel Ring
- Black or White Polymer Base
- Waterproof Snap-On Cover
- Pigtail Leads

Fig. 1045 (2 Pin)

Fits Figs. 1343, 1347, 1348, 1349, 1400, 1440, 1442, 1450, 1451, 1452, 1460, 1454, 1470 Series All-Round Pole Lights 1612 and 1616 Series Bi-color Pole Lights

Fig. 1045 (3 Pin) - Fits Figs. 1211 & 1421 Series Bi-Color Pole Lights

Locking Collar is Included with Dealer Package To Allow Interchangeability with Discontinued Style Bases

ORDERING & TECH INFO

Finish	Number of Pins	Base Dimensions Inches	Tube Angle Degrees	Dealer Pkg. 5 Cards 1 Pc. per Card	OEM Bulk Pkg. 50 Pcs.	Screw Size	Ship Wt. Carton Lbs. DP/OEM Bulk
Chr Brass/Blk	2	2-1/4 O.D.	0	1045P00DP	1045P00CHR	8	1.7/8.9
Chr Brass/Wht	2	2-1/4 O.D.	0	_____	1045P0WCHR	8	—/8.9
Chr Brass/Blk	3	2-1/4 O.D.	0	1045300DP	1045300CHR	8	1.7/9.4
Chr Brass/Wht	3	2-1/4 O.D.	0	_____	104530WCHR	8	—/9.4
Stainless/Blk	2	2-1/4 O.D.	0	1045P0SDP	1045P00STS	8	1.7/8.9
Stainless/Wht	2	2-1/4 O.D.	0	_____	1045P0WSTS	8	—/8.9
Stainless/Blk	3	2-1/4 O.D.	0	104530SDP	1045300STS	8	1.7/9.4
Stainless/Wht	3	2-1/4 O.D.	0	_____	104530WSTS	8	—/9.4



Fig. 1046
5° Rake

Fig. 1046 (2 Pin) - Plug-In Type Base Fig. 1047 (2 Pin) and (3 Pin) - Plug-In Type Bases

CONSTRUCTION:

- Chrome Plated Brass or Stainless Steel and Black Polymer
- Water Resistant Slide Cover
- Pigtail Leads

Fig. 1046 (2 Pin)

Fits Figs. 1343, 1347, 1348, 1349, 1400, 1445, 1447, 1451, 1455, 1456, 1465, and 1470 Series All-Round Pole Lights

Fig. 1047 (2 Pin)

Fits Figs. 1343, 1347, 1348, 1349, 1400, 1440, 1442, 1450, 1451, 1452, 1454, 1460, 1470 Series All-Round Pole Lights and 1616 Series Bi-color Pole Lights

Fig. 1047 (3 Pin)

Fits Figs. 1211 & 1421 Series Bi-color Pole Lights

ORDERING & TECH INFO

Finish	Number of Pins	Base Dimensions Inches	Tube Angle Degrees	Dealer Pkg. 5 Cards 1 Pc. per Card	OEM Bulk Pkg. 50 Pcs.	Screw Size	Ship Wt. Carton Lbs. DP/OEM Bulk
Chrome Brass	2	3-1/2 x 1-1/2	5	1046P00DP	1046P00CHR	8	1.5/11.9
Stainless Steel	2	3-1/2 x 1-1/2	5	1046P0SDP	1046P00STS	8	1.5/11.9
Chrome Brass	2	3-1/2 x 1-1/2	0	1047P00DP	1047P00CHR	8	1.5/11.9
Stainless Steel	2	3-1/2 x 1-1/2	0	1047P0SDP	1047P00STS	8	1.5/11.9
Chrome Brass	3	3-1/2 x 1-1/2	0	10473B0DP	10473B0CHR	8	1.5/11.9
Stainless Steel	3	3-1/2 x 1-1/2	0	10473BSDP	10473B0STS	8	1.5/11.9

Fig. 1047 (2 Pin)
Fig. 1047 (3 Pin)
0° Rake

LOCKING COLLAR POLE LIGHT MOUNTING BASES

Fig. 1059 (2 Pin) - Plug-In Type Base

CONSTRUCTION:

- Black Polymer and Chrome Plated Zinc Alloy
- Waterproof Snap-On Cover
- Pigtail Leads

Fig. 1059 (2 Pin)

Fits Figs. 1330, 1343, 1347, 1348, 1349, 1400, 1451 and 1470 Series All-Round Pole Lights

Locking Collar is Included with Dealer Package To Allow Interchangeability with Discontinued Style Bases



1



Fig. 1059
16° Rake

ORDERING & TECH INFO

Number of Pins	Base Dimensions Inches	Tube Angle Degrees	Dealer Pkg. 5 Cards 1 Pc. per Card	OEM Bulk Pkg. 50 Pcs.	Screw Size	Ship Wt. Carton Lbs. DP/OEM Bulk
2	3-3/4 x 1-5/8	16	1059P00DP	1059P00CHR	8	2.7/22.0

Fig. 1060 (2 Pin) - Plug-In Type Base

Fig. 1060 (3 Pin) - Plug-In Type Base

CONSTRUCTION:

- Black Polymer and Chrome Plated Zinc Alloy
- Black Polymer Insert
- Waterproof Snap-On Cover
- Pigtail Leads

Fig. 1060 (2 Pin)

Fits Figs. 1343, 1347, 1348, 1349, 1400, 1445, 1447, 1451, 1455, 1456, 1465 and 1470 Series All-Round Pole Lights

Fig. 1060 (3 Pin)

Fits Figs. 1212 & 1422 Series Bi-color Pole Lights

Locking Collar is Included with Dealer Package To Allow Interchangeability with Discontinued Style Bases



Fig. 1060 (2 Pin)
Fig. 1060 (3 Pin)
5° Rake

ORDERING & TECH INFO

Number of Pins	Base Dimensions Inches	Tube Angle Degrees	Dealer Pkg. 5 Cards 1 Pc. per Card	OEM Bulk Pkg. 50 Pcs.	Screw Size	Ship Wt. Carton Lbs. DP/OEM Bulk
2	3-3/4 x 1-3/4	5	1060PB0DP	1060PB0CHR	8	2.4/18.5
3	3-3/4 x 1-3/4	5	10603B0DP	10603B0CHR	8	2.5/19.0

PERKO® THREADED COLLAR POLE LIGHT MOUNTING BASES

1



Fig. 1048
5° Rake



Fig. 1048 (2 Pin) - Plug-In Type Base

CONSTRUCTION:

- Chrome Plated Brass or Stainless Steel
 - Black or White Polymer
- Waterproof Snap-On Cover
 - Pigtail Leads

Fig. 1048 (2 Pin)

Fits Figs. 1343, 1347, 1348, 1349, 1451, 1470, 1622, 1624 and 1656 Series All-Round Pole Lights

ORDERING & TECH INFO

Finish	Number of Pins	Base Dimensions Inches	Tube Angle Degrees	Dealer Pkg. 5 Cards 1 Pc. per Card	OEM Bulk Pkg. 50 Pcs.	Screw Size	Ship Wt. Carton Lbs. DP/OEM Bulk
Chr Brass & Black	2	3-1/2 x 2	5	1048P00DP	1048P00CHR	8	1.3/9.3
Chr Brass & White	2	3-1/2 x 2	5	_____	1048P0WCHR	8	1.3/9.3
Stainless Steel & Black	2	3-1/2 x 2	5	1048P0SDP	1048P00STS	8	1.3/9.3
Stainless Steel & White	2	3-1/2 x 2	5	_____	1048P0WSTS	8	1.3/9.3



Chrome Cap



Black or White Cap

Fig. 1049 (2 Pin or 3 Pin) - Mini Mount Plug-In Type Base

CONSTRUCTION:

- Plain Black or White Cap
- Optional Chrome Plated Brass Insert
- Waterproof Snap-On Cover
- Black or White Polymer Base
 - Pigtail Leads

Fig. 1049 (2 Pin)

Fits Figs. 1401, 1441, 1443 and 1461 Series All-Round Pole Lights
1614 and 1618 Series Bi-Color Pole Lights

ORDERING & TECH INFO

Cap Type	Number of Pins	O.D. Base Dimensions Inches	Tube Angle Degrees	Dealer Pkg. 5 Cards 1 Pc. per Card	OEM Bulk Pkg. 50 Pcs.	Ship Wt. Carton Lbs. DP/OEM Bulk
Black	2	1-15/16	0	1049P00DPB	1049P00BLK	1.2/7.1
White	2	1-15/16	0	_____	1049P00WHT	—/7.1
Black	3	1-15/16	0	10493B0DPB	10493B0BLK	1.2/7.6
White	3	1-15/16	0	_____	10493B0WHT	—/7.6
Chrome/Black	2	1-15/16	0	1049P00DPC	1049P00CHR	1.3/8.0
Chrome/White	2	1-15/16	0	_____	1049P0WCHR	—/8.0
Chrome/Black	3	1-15/16	0	10493B0DPC	10493B0CHR	1.4/8.5
Chrome/White	3	1-15/16	0	_____	10493BWCHR	—/8.5

Fig. 1049
0° Rake

Mini-Mount Base
Shown with
tool for easy
Installation



Note: Requires Access from Underneath for Installation and Service

SPARE PARTS ORDERING INFORMATION

Black Cap for Base: 1049DPB99A
Black Cap with Chrome Brass Insert for Base: 1049DPC99A
Installation Tool: 1049ITL99A

FIXED MOUNT L.E.D. WHITE ALL-ROUND LIGHTS

Fig. 1344 L.E.D. White All-Round Light

Certified For Use on Sail or Power Driven Vessels Under 20 Meters (65.6 ft.) in Length

Fig. 1345 L.E.D. White All-Round Light

Certified For Use on Power Driven Vessels Under 20 Meters (65.6 ft.) in Length

CONSTRUCTION:

- Reduced Glare Design
- White Polymer Top with Clear Fluted Lens & Frosted Globe
- Fixed Mount White Polymer Base



1

Fig. 1344



Fig. 1345



ORDERING INFO

Vertical Height Inches	Dealer Pkg. 1 Pc. per Card	OEM Bulk Pkg. 1 Pc.	Ship Wt. Carton Lbs. DP/OEM Bulk
7-7/8	1344DP1WHT	1344001WHT	0.8/0.5
7-1/8	1345DP1WHT	1345001WHT	0.8/0.5

TECH INFO

- L.E.D.: 12 Volt
- Pole: 3/4" Dia. Anodized
- Screw Size: #8

Base Dimensions:
1" x 2-5/8"

STEALTH Series Fig. 1608 Fixed Mount L.E.D. White All-Round Light

Patent Pending

Certified For Use on Power Driven Vessels Under 20 Meters (65.6 ft.) in Length

CONSTRUCTION:

- Reduced Glare Design
- Black Polymer Top with Clear Fluted Lens
- Fixed Mount Black Polymer Base



Fig. 1608 #1



Fig. 1608 #0

ORDERING INFO

Vertical Height Inches	Dealer Pkg. 1 Card 1 Pc. per Card	OEM Bulk Pkg. 25 Pcs.	Ship Wt. Carton Lbs. DP/OEM Bulk
6-5/8	1608DPOBLK	1608000BLK	0.7/6.0
4-1/2	1608DP1BLK	1608001BLK	0.6/5.0

TECH INFO

- L.E.D.: 12 Volt
- Pole: 3/4" Dia. Anodized
- Screw Size: #8

Base Dimensions:
1" x 2-5/8"

FIXED MOUNT WHITE ALL-ROUND LIGHTS

1



Fig. 1301

Fig. 0170SWB

- White Translucent Globe and Black or White Polymer Top
- Fixed Mount Black or White Polymer Base

Figs. 0170 SWB & 1301

Certified For Use on Sail or Power Driven Vessels Under 20 Meters (65.6 ft.) in Length

CONSTRUCTION:

ORDERING INFO					
Color	Voltage	Vertical Height Inches	Dealer Pkg. 5 Cards 1 Pc. per Card	OEM Bulk Pkg. 50 Pcs.	Ship Wt. Carton Lbs. DP/OEM Bulk
Black	12	3-7/8	0170SWBDP1	0170SWB12V	1.7/10.0
White	12	3-7/8	_____	0170SWBW12	—/10.0
Black	24	3-7/8	0170SWBDP2	0170SWB24V	1.7/10.0
White	24	3-7/8	_____	0170SWBW24	—/10.0
Black	12	7-1/8	1301DPOCHR	1301000CHR	2.2/11.6
White	12	7-1/8	_____	1301000WHT	—/11.6

TECH INFO	
Base Dimensions: 1" x 2-5/8"	
• Screw Size: #8	
1301	
• Pole: 3/4" Dia. Anodized	

SPARE PARTS ORDERING INFORMATION

12 Volt Bulbs (2 per card): 0337012DP.
Globe: 0201DPOWHT.
24 Volt Bulb For Fig. 0170, (1 per card): 0337014DP.



Fig. 0455 #1



Fig. 0466 #2



Fig. 0455 White All-Round Light - Certified For Use on Power Driven Vessels Under 20 Meters (65.6 ft.) in Length

Fig. 0466 White All-Round Light - Certified For Use on Sail or Power Driven Vessels Under 20 Meters (65.6 ft.) in Length

CONSTRUCTION:

- Fig. 0455 Clear Fresnel Globe
- Fig. 0466 Frosted Fresnel Globe
- Black or White Polymer • Fixed Mount

ORDERING INFO			
Vertical Height Inches	Dealer Pkg. 5 Cards 1 Pc. per Card	OEM Bulk Pkg. 50 Pcs.	Ship Wt. Carton Lbs. DP/OEM Bulk
4-1/2	0455DP1CHR	0455001CHR	2.4/16.1
4-1/2	_____	0455001WHT	—/16.1
11-7/8	0455DP2CHR	0455002CHR	3.0/18.2
11-7/8	_____	0455002WHT	—/18.2
4-1/2	0466DP1CHR	0466001CHR	2.0/12.8
11-7/8	0466DP2CHR	0466002CHR	3.3/17.8

TECH INFO	
• Bulb: 12 Volt (Included) • Size #2	
Pole: 3/4" Dia. Anodized	
• O.D. Base: 2-1/8"	
• Screw Size: #8	

SPARE PARTS ORDERING INFORMATION

Bulbs (2 per card): 0337011DP. Fig. 0455 Globe: 0248DPOCLR. Fig. 0466 Globe: 0248000FRD.



Fig. 1604 #0

Fig. 1604 #1



Fig. 1604 White All-Round Lights

Certified For Use on Power Driven Vessels Under 20 Meters (65.6 ft.) in Length

CONSTRUCTION:

- Reduced Glare Design
- Black Polymer Top with Clear Fluted Lens & Frosted Globe
- Fixed Mount Black Polymer Base

ORDERING INFO			
Vertical Height Inches	Dealer Pkg. 5 Cards 1 Pc. per Card	Ship Wt. OEM Bulk Pkg. 50 Pcs.	Carton Lbs. DP/OEM Bulk
7-1/8	1604DPOCHR	1604000CHR	2.2/13.3
2-5/8	1604DP1CHR	1604001CHR	1.3/7.0

TECH INFO	
• Bulb: 12 Volt (Included)	
• Pole: 3/4" Dia. Anodized	
• Screw Size: #8	
Base Dimensions: 1" x 2-5/8"	

SPARE PARTS ORDERING INFORMATION

Bulbs (2 per card): 0338DP2CLR. Globe: 0239DP0BLK.

PERKO® FIXED MOUNT WHITE ALL-ROUND LIGHTS

Figs. 0362 & 0371 - White All-Round Lights

Certified For Use on Sail or Power Driven Vessels
Under 20 Meters (65.6 ft.) in Length



1

CONSTRUCTION:

- Frosted Globe
- Double Contact Socket
- Plain or Chrome Plated Cast Bronze
- 12 Volt Bulb Included

Fig. 0371



Fig. 0362

ORDERING INFO & TECH INFO

Vertical Height Inches	O.D. Base Inches	Plain Bronze Dealer Pkg.	Chrome Plated Bronze Dealer Pkg.	Screw Size	Tapped Pipe Size Inches	Ship Wt. Carton Lbs. Dealer Pkg.
		5 Cards 1 Pc. per Card	5 Cards 1 Pc. per Card			
1-1/2	—	0362DP0PLB	0362DP0CHR	—	1/2	3.0
1-1/2	2-1/2	0371DP0PLB	0371DP0CHR	#8 F.H.	—	2.7

SPARE PARTS ORDERING INFORMATION

Bulbs (2 per card): 0337011DP. Globe: 0248000FRD. Socket: 0024DP1.

PLUG-IN MOUNT WHITE ALL-ROUND LIGHT

Fig. 1131 - White All-Round Light with Plug-In Mounting Base

Certified For Use on Sail or Power Driven Vessels
Under 20 Meters (65.6 ft.) in Length



CONSTRUCTION:

- White Translucent Globe and Black Polymer Top
- Polymer Adapters Available for Flat or "V" Type Mounts
- Waterproof Screw-On Cover for Mounting Base
- Great for Mounting on Small John Boats or Aluminum Boats



ORDERING INFO

Pole Length Inches	Dealer Pkg.	OEM Bulk Pkg.	Ship Wt.
	10 Cards 1 Pc. per Card	25 Pcs.	Carton Lbs. DP/OEM Bulk
24	1131DP2CHR	1131002CHR	4.5/15.0
36	1131DP4CHR	1131004CHR	5.8/16.0
42	1131DP5CHR	1131005CHR	6.8/17.0

TECH INFO

- Pole Rake: 0°
 - Bulb: 12 Volt (Included)
 - Pole: 3/4" Dia. Anodized
 - Screw Size: #8
 - Threaded Collar
- Base Dimensions:**
2-1/4" x 3/4"

SPARE PARTS ORDERING INFORMATION

Bulbs (2 per card): 0337012DP. White Translucent Globe: 0201DP0WHT.
Spare Base with Socket Assembly: 1123DP099A.
Spare Cap for Base: 0125DP0BLK.



Fig. 1131

FOLD-DOWN POLE LIGHT BASE MOUNTING OPTIONS

1

Fold Down Mount Lights

For Use on Windshields, T-Tops, Rails, Arches and Hard Tops

Horizontal Mount Bases

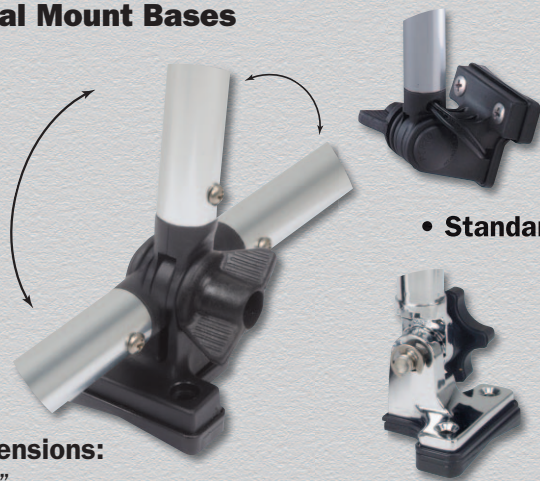

Base Dimensions:
2" x 1-1/2"

Features:

- Polymer adapters for flat or "V-type" mounting
 - Notch for through base wiring
- Folds down 90° in either direction opposite the plane of attachment plate of the mount
- **Standard Duty:** Black polymer base with 0° to 180° adjustment
 - for poles less than 18" long
- **Heavy Duty:** Chrome Plated Zinc alloy base 30° graduated adjustment increments
 - For poles less than 48" long
 - Consult factory for ordering details

Vertical Mount Bases

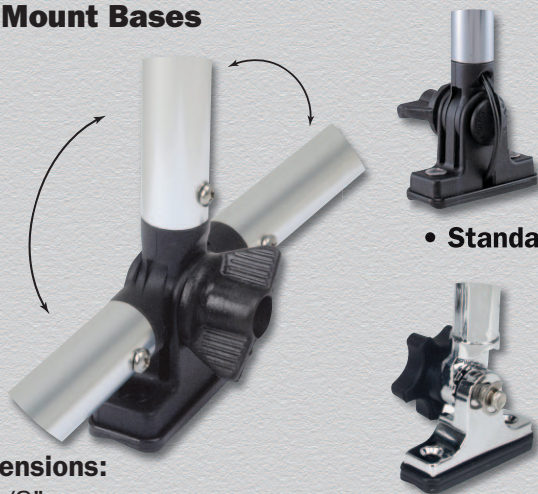

Base Dimensions:
2-1/4" x 5/8"

Features:

- Polymer adapters for flat or "V-type" mounting
 - Notch for through base wiring
- Folds down 90° in either direction opposite the plane of attachment plate of the mount
- **Standard Duty:** Black polymer base with 0° to 180° adjustment
 - for poles less than 18" long
- **Heavy Duty:** Chrome Plated Zinc alloy base 30° graduated adjustment increments
 - For poles less than 48" long
 - Consult factory for ordering details

Vertical Mount Base with Quick Adjust Handle

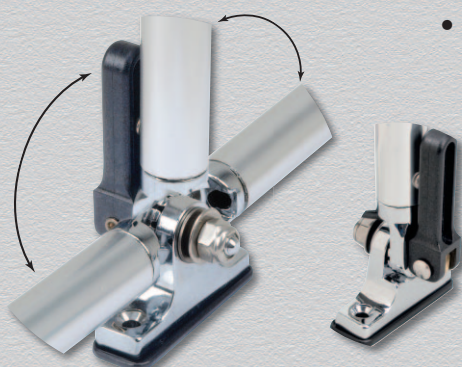

Base Dimensions:
2-1/4" x 5/8"

Features:

- Allows pole light to fold down 90° in either direction along the plane of attachment plate of the mount
 - Chrome plated zinc alloy base
- Ideal for use on pontoon boat square rails or any flat mounting surface
 - Quick adjust handle
- 30° graduated adjustment increments
 - For poles less than 48" long

SPARE PARTS ORDERING INFORMATION

Polymer Bracket with Knob and End Plug for Horizontal Mount: 1052DPBBLK.
 Polymer Spare Bracket with Knob and End Plug for Vertical Mount: 1054DPBBLK.
 Bracket for Vertical Mount Quick Release: 1058DPOCHR
 Zinc Bracket with Knob and End Plug for Horizontal Mount: 1052DPOCHR.
 Zinc Bracket with Knob and End Plug for Vertical Mount: 1054DPOCHR.
 Knob for Zinc Bases: 1144A00BLK

FOLD DOWN MOUNT POLE LIGHT HEAD OPTIONS

1

Figs. 1134, 1137, 1138, 1634, 1637 & 1638 Fold Down White All-Round Lights

Certified For Use on Sail or Power Driven Vessels Under 20 Meters (65.6 ft.) in Length



- White Translucent Globe
- 12 Volt Bulb Included
- **Figs. 1134 & 1137**
- Black Polymer Base
- **Fig. 1138**
- Chrome Plated Zinc Alloy Base
- Quick Adjust Lever



- Reduced Glare Design
- Black Polymer Top with Clear Fluted Lens & Frosted Globe
- 12 Volt Bulb Included
- **Figs. 1634 & 1637**
- Black Polymer Base
- **Fig. 1638**
- Chrome Plated Zinc Alloy Base
- Quick Adjust Lever



STEALTH Series

Figs. 1636 & 1639

- Reduced Glare Design
- LED 12-Volt
- Black Polymer Top with Clear Fluted Lens
- Black Polymer Base

Fig. 1642



- Reduced Glare Design LED 12-Volt
- Black Polymer Top with Clear Fluted Lens
- Chrome Plated Zinc Alloy Base
- Quick Adjust Lever

ORDERING INFO WHITE ALL ROUND LIGHTS

Base Mount	Vertical Height Inches	Dealer Pkg. 5 Cards 1 Pc. per Card	OEM Bulk Pkg. 50 Pcs.	Ship Wt. Carton Lbs. DP/OEM Bulk
Horizontal	14	1134DPOCHR	1134000CHR	3.4/22.5
Vertical	14	1137DPOCHR	1137000CHR	3.3/21.5
Quick Adjust	14	1138DPOCHR	1138000CHR	4.0/29.5
Horizontal	13-3/8	1634DPOCHR	1634000CHR	3.0/21.5
Vertical	13-3/8	1637DPOCHR	1637000CHR	3.2/20.5
Quick Adjust	13-3/8	1638DPOCHR	1638000CHR	4.0/27.9

Base Mount	Vertical Height Inches	Dealer Pkg. 1 Card 1 Pc. per Card	OEM Bulk Pkg. 10 Pcs.	Ship Wt. Carton Lbs. DP/OEM Bulk
Horizontal	13-3/8	1636DPOCHR	1636000CHR	1.0/6.0
Vertical	13-3/8	1639DPOCHR	1639000CHR	1.0/6.0
Quick Release	13-3/8	1642DPOCHR	1642000CHR	1.1/7.0

TECH INFO

Pole: 3/4" Dia. Anodized
Screw Size: #8

Base Dimensions:

Horizontal Mt.: 2" x 1-1/2"
Vertical Mt.: 2-1/4" x 5/8"
Quick Adjust: 2-1/4" x 5/8"

SPARE PARTS ORDERING INFORMATION

Figs. 1134, 1137 & 1138 Bulbs (2 per card): 0337012DP.
Figs. 1134, 1137 & 1138 Globe: 0201DPOWHT.
Figs. 1634, 1637 & 1638 Bulbs (2 per card): 0338DP2CLR.
Figs. 1634, 1637 & 1638 Globe: 0239DPOBLK.

Fold Down Combination Masthead/White All-Round Lights

Figs. 1181 & 1184 - Certified For Use on Sail or Power Driven Vessels Under 20 Meters (65.6 ft.) in Length

Figs. 1281 & 1284 - Certified For Use on Sail or Power Driven Vessels Under 12 Meters (39.4 ft.) in Length

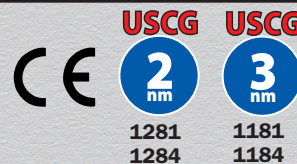

1281
1284

1181
1184

ORDERING INFO COMBINATION WHT ALL RND/MASTHEAD LIGHTS

Base Mount	Vertical Height Inches	Dealer Pkg. 5 Cards 1 Pc. per Card	OEM Bulk Pkg. 50 Pcs.	Ship Wt. Carton Lbs. DP/OEM Bulk
Horizontal	12-13/16	1181DPOCHR	1181000CHR	4.3/31.7
Vertical	12-13/16	1184DPOCHR	1184000CHR	4.3/31.0
Horizontal	12-3/16	1281DPOCHR	1281000CHR	3.2/23.0
Vertical	12-3/16	1284DPOCHR	1284000CHR	2.5/23.0

SPARE PARTS ORDERING INFORMATION

For Figs. 1181 & 1184

Spare Bulbs (2 per card): 0071DPOCLR.
Spare Lenses (2 per card): 0278DPOWHT.
Spare Top Cap with Screw: 1158DPOBLK.

For Figs. 1281 & 1284

Spare Bulbs (2 per card): 0338DP1CLR.
Spare Lens Assembly: 0240DPOLNS.

Figs. 1181 & 1184

- Black Polymer and Chrome Plated Zinc Alloy Top
- Black Polymer Base

Figs. 1281 & 1284

- Reduced Glare Design
- Black Polymer Top with Clear Polymer Lens
- Black Polymer Base



NOTE: Figs. 1181 and 1184 meet the USCG requirements for 12 & 24 volt applications. To use Figs. 1181 and 1184 as 24-volt lights, replace the bulbs provided with Cat. No. 0072DP1CLR 24-volt bulbs.

FOLDING MOUNT WHITE ALL-ROUND LIGHTS

1

USCG



Fig. 1607



Fig. 1607



Fig. 1609
STEALTH

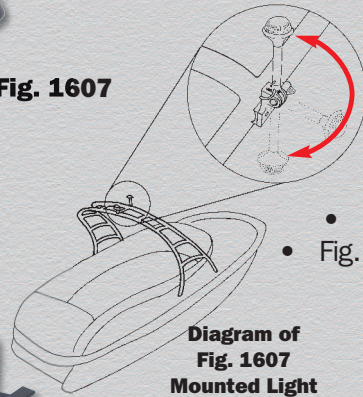

Fig. 1607 - Tower/Arch Mount Folding White All-Round Light
Fig. 1609 - *STEALTH* L.E.D. Series Tower/Arch Mount Folding White All-Round Light

Certified For Use on Power Driven Vessels Under 20 Meters (65.6 ft.) in Length

CONSTRUCTION:

- Reduced Glare Design
 - Fig. 1607 - Black Polymer Top with Frosted Globe
 - Fig. 1609 - Black Polymer Top with Clear Fluted Lens
 - Fold-Down, Adjustable Angle
 - Black Polymer Base
- Tower/Arch Mount Features**
- 360° All-Round Navigation Light in the up position for all nighttime boating or while at anchor
 - A cockpit courtesy light in the down position while at the dock
 - Forward and out of the way for daytime skiing or boarding



ORDERING INFO

Vertical Height Inches	Dealer Pkg. 1 Pc. per Card	Qty. DP	OEM Bulk Pkg.		Ship Wt. Carton Lbs. DP/OEM Bulk
			Qty. Bulk	Qty. Bulk	
6-3/4	1607DPOCHR	5	1607000CHR	50	2.9/16.6
7-3/4	1609DPOCHR	1	1609000CHR	10	0.8/7.0

TECH INFO

- Fig 1607: 12 Volt Bulb (Included)
 - Fig 1609: 12 Volt L.E.D.
 - Pole: 3/4" Dia. Anodized
 - Screw Size: #8
- Base Dimensions:**
2" x 1-1/2"

SPARE PARTS ORDERING INFORMATION FOR FIG. 1607

Bulbs (2 per card): 0338DP2CLR. Lens Assembly: 0239DP0BLK.

PLUG-IN MOUNT COMBINATION MASTHEAD/WHITE ALL-ROUND LIGHT

USCG



Fig. 1125
16° Rake

Fig. 1125 Masthead/White All-Round Light
Certified For Use on Sail or Power Driven Vessels Under 20 Meters (65.6 ft.) in Length

CONSTRUCTION:

- Black Polymer and Chrome Plated Zinc Alloy Top
 - Chrome Plated Brass Base
 - Stow-A-Way Plug-In Type
- Waterproof Cover for Base that Attaches to Deck Mounted Retainer when Light is in Place

ORDERING INFO

Vertical Height Inches	Dealer Pkg. 5 Cards 1 Pc. per Card	OEM Bulk Pkg.		Ship Wt. Carton Lbs. DP/OEM Bulk
		Qty. Bulk	Qty. Bulk	
33-7/8	1125DP4CHR	1125004CHR	50	7.6/40.9

TECH INFO

- Bulb: 12 Volt (Included)
- Pole Rake: 16°
- Pole: 3/4" Dia. Anodized
- Threaded Collar
- Screw Size: #8

SPARE PARTS ORDERING INFORMATION

Bulbs (2 per card): 0071DPOCLR. Cap for Base: 0125DP0BLK.
Lenses (2 per card): 0278DPOWHT. Base with Socket Assembly: 1125DP099A.
Top Cap with Screw: 1158DP0BLK. Replacement Pole Light : 1125DP499A.

Base Dimensions:

3-3/8" x 2-1/4"

NOTE: The above lights on this page meet the USCG requirements for 12 volt applications. Fig. 1125 also meets the USCG requirements for 24 volt applications. To use Fig. 1125 as a 24-volt light, replace the bulbs provided with Cat. No. 0072DP1CLR 24-volt bulbs.

PLUG-IN MOUNT COMBINATION MASTHEAD/WHITE ALL-ROUND POLE LIGHTS

Figs. 1123 & 1124 Masthead/White All-Round Lights

Certified For Use on Sail or Power Driven Vessels
Under 20 Meters (65.6 ft.) in Length

CONSTRUCTION:

- Black Polymer and Chrome Plated Zinc Alloy Top
- Chrome Plated Zinc Alloy Mounting Base
- Waterproof Cover For Mounting Base
- Stow-A-Way Plug-In Type Pole
- Polymer Adapter for Flat or "V" Type 45 Degree Windshields

Fig. 1123 - Horizontal Mount

Fig. 1124 - Vertical Mount



1

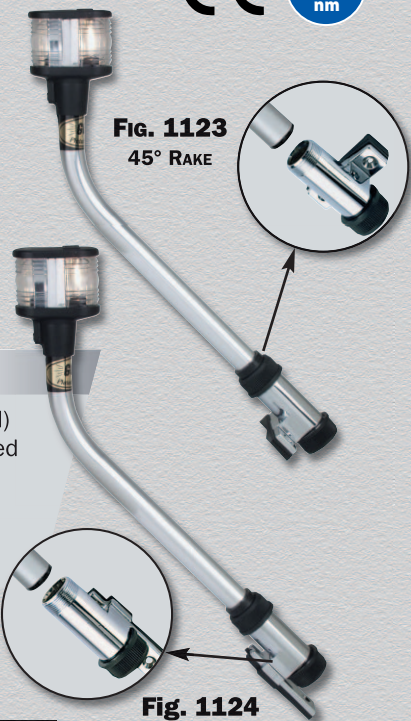

Fig. 1123
45° RAKE

Fig. 1124
45° Rake

ORDERING INFO

Vertical Height Inches	Dealer Pkg. 5 Cards 1 Pc. per Card	OEM Bulk Pkg. 50 Pcs.	Ship Wt. Carton Lbs. DP/OEM Bulk
11-1/4	1123DP1CHR	1123001CHR	5.6/26.3
12-1/2	1124DP1CHR	1124001CHR	5.7/25.4
20-1/2	1123DP2CHR	1123002CHR	6.6/31.9
22	1124DP2CHR	1124002CHR	6.9/32.4

TECH INFO

Bulb: 12 Volt (Included)
Pole: 3/4" Dia. Anodized
Screw Size: #8

Base Dimensions:
1123: 2-1/4" x 3/4"
1124: 3/4" x 2-1/4"

SPARE PARTS ORDERING INFORMATION

Bulbs (2 per card): 0071DPOCLR. Cap for Base: 0125DPOBLK
Lenses (2 per card): 0278DPOWHT. Top Cap with Screw: 1158DPOBLK.
Fig. 1123 Base with Socket Assembly: 1123DPO99A. Fig. 1124 Base with Socket Assembly: 1124DPO99A.
Replacement Pole for Size No. 1: 1123DP199A. Replacement Pole for Size No. 2: 1123DP299A.

NOTE: The above lights on this page meet the USCG requirements for 12 & 24 volt applications. To use Figs. 1123 and 1124 as 24-volt lights, replace the bulbs provided with Cat. No. 0072DP1CLR 24-volt bulbs.

Figs. 1273 & 1274 Masthead/White All-Round Lights

Certified For Use on Power Driven Vessels
Under 12 Meters (39.4 ft.) in Length

CONSTRUCTION:

- "Reduced Glare" Design
- Black Polymer Top
- Chrome Plated Zinc Alloy Mounting Base
- Waterproof Cover For Mounting Base
- Stow-A-Way Plug-In Type Pole
- Polymer Adapter for Flat or "V" Type 45 Degree Windshields

Fig. 1273 - Horizontal Mount

Fig. 1274 - Vertical Mount

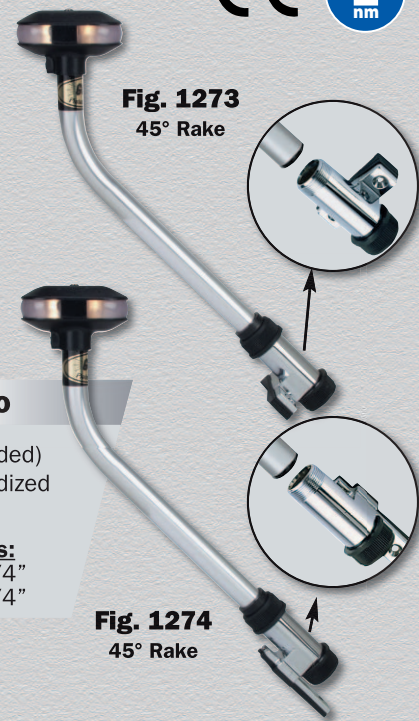

Fig. 1273
45° Rake

Fig. 1274
45° Rake

ORDERING INFO

Vertical Height Inches	Dealer Pkg. 5 Cards 1 Pc. per Card	OEM Bulk Pkg. 50 Pcs.	Ship Wt. Carton Lbs. DP/OEM Bulk
10-5/8	1273DP1CHR	1273001CHR	4.7/22.1
11-7/8	1274DP1CHR	1274001CHR	4.7/21.2
20	1273DP2CHR	1273002CHR	6.1/28.2
21-5/8	1274DP2CHR	1274002CHR	6.1/29.1

TECH INFO

Bulb: 12 Volt (Included)
Pole: 3/4" Dia. Anodized
Screw Size: #8

Base Dimensions:
1273: 2-1/4" x 3/4"
1274: 3/4" x 2-1/4"

SPARE PARTS ORDERING INFORMATION

Bulbs (2 per card): 0338DP1CLR. Lens Assembly: 0240DPOLNS. Cap for Base: 0125DPOBLK.
Fig. 1273 Base with Socket Assembly: 1123DPO99A. Fig. 1274 Base with Socket Assembly: 1124DPO99A.
Replacement Pole for Size No. 1: 1273DP199A. Replacement Pole for Size No. 2: 1273DP299A

FIXED MOUNT COMBINATION MASTHEAD/WHITE ALL-ROUND LIGHTS

1



Figs. 1183, 1196 & 1197 Masthead/White All-Round Lights

Certified For Use on Sail or Power Driven Vessels
Under 20 Meters (65.6 ft.) in Length



Fig. 1183

Fig. 1197

Fig. 1196

CONSTRUCTION:

- Black or White Polymer and Chrome Plated Zinc Alloy Top
- Black or White Polymer Base (Figs. 1183 & 1196)
- 3/4 Inch Diameter Anodized Aluminum Tube

Figs. 1183 & 1196 - Fixed Mount
Fig. 1197 - Fixed Mount Short Pole with Pigtail Leads

ORDERING INFO					TECH INFO
	Vertical Height Inches	Dealer Pkg. 5 Cards 1 Pc. per Card	OEM Bulk Pkg. 50 Pcs.	Ship Wt. Carton Lbs. DP/OEM Bulk	Screw Size: #8 1183 & 1196 Bulb: 12 Volt (Included) Pole: 3/4" Dia. Anodized
Color					
Black	3-3/16	1183DPOCHR	1183000CHR	2.1/18.7	Base Dimensions: 1183 & 1196: 1" x 2-5/8"
White	3-3/16	—————	1183000WHT	—/18.7	
Black	5-1/16	1196DP1CHR	1196001CHR	2.5/19.0	1197: Pole Length: 1"
Black	11-1/4	1196DP2CHR	1196002CHR	3.5/26.0	
Black	4	1197DPOCHR	1197000CHR	2.1/18.1	

NOTE: The lights on this page meet the USCG requirements for 12 & 24 volt applications. To use Figs. 1183, 1196 and 1197 as 24-volt lights, replace the bulbs provided with Cat. No. 0072DP1CLR 24-volt bulbs.



Figs. 1236 & 1283 Masthead/White All-Round Lights

Certified For Use on Power Driven Vessels
Under 12 Meters (39.4 ft.) in Length



Fig. 1236

Fig. 1283

CONSTRUCTION:

- "Reduced Glare" Design
- Black or White Polymer Top and Base
- 3/4 Inch Diameter Anodized Aluminum Tube
- Fixed Mount

ORDERING INFO					TECH INFO
	Vertical Height Inches	Dealer Pkg. 5 Cards 1 Pc. per Card	OEM Bulk Pkg. 50 Pcs.	Ship Wt. Carton Lbs. DP/OEM Bulk	Screw Size: #8 Bulb: 12 Volt (Included) Pole: 3/4" Dia. Anodized
Color					
Black	4-1/4	1236DP1BLK	1236001BLK	1.8/10.8	Base Dimensions: 1" x 2-5/8"
White	4-1/4	—————	1236001WHT	—/10.8	
Black	10-1/2	1236DP2BLK	1236002BLK	2.0/17.2	
White	10-1/2	—————	1236002WHT	—/17.2	
Black	2-1/4	1283DPOBLK	1283000BLK	1.3/10.0	
White	2-1/4	—————	1283000WHT	—/10.0	

SPARE PARTS ORDERING INFORMATION

FOR Figs. 1183, 1196 & 1197
Bulbs (2 per card): 0071DPOCLR.
Lenses (2 per card): 0278DPOWHT.
Black Top Cap with Screw: 1158DPOBLK.

FOR Figs. 1236 & 1283
Bulbs (2 per card): 0338DP1CLR.
Black Top with Lens Assembly: 0240DPOLNS.

VERTICAL SURFACE MOUNT MASTHEAD LIGHTS

Fig. 0170 Masthead Light - Certified For Use On Sail or Power Driven Vessels Under 20 Meters (65.6 ft.) in Length (12 or 24 Volts)



1

CONSTRUCTION OPTIONS:

- Chrome Plated Brass Top with Black Polymer Base
- All Black Polymer
- All White Polymer

Note: 12 volt 0120 Series lights are superseded by the 0170 Series



Fig. 0170MM0



Fig. 0170BM0



Fig. 0170WM0

Note:

See Pages 60 & 61 for Complete Series and Spare Parts Ordering Information.

ORDERING INFO

Finish	Dealer Pkg.	Standard Pkg.	Screw Size	Ship Wt. Carton Lbs. DP/Std. Pkg.
	5 Cards 1 Pc. per Card	1 Pc.		
12 Volt				
Chrome	0170MM0DP1	0170MM012V	10	0.5/2.4
Black	0170BM0DP1	0170BM012V	10	0.5/2.4
White	0170WM0DP1	0170WM012V	10	0.5/2.4
24 Volt				
Chrome	0170MM0DP2	0170MM024V	10	0.5/2.4
Black	0170BM0DP2	0170BM024V	10	0.5/2.4
White	0170WM0DP2	0170WM024V	10	0.5/2.4

TECH INFO

- Projection Overall: 2-1/2"
- Height Overall: 3-5/8"
 - Width: 4-1/8"
 - Screw Size: #10
- 12 or 24 Volt Bulb Included



LED Versions Available. See Page 59.



COMBINATION MASTHEAD DECK SPREADER LIGHT

Fig. 0170 BMD - Certified For Use On Sail or Power Driven Vessels Under 20 Meters (65.6 ft.) in Length



CONSTRUCTION:

- Black Polymer
- Combination Spreader and Deck Illumination Lights

ORDERING INFO

Overall Dimensions Inches	Dealer Pkg.	Std. Pkg.	Ship Wt. Carton Lbs. DP/Std. Pkg.
	5 Cards 1 Pc. per Card	1 Pc.	
7 x 4-1/8	0170BMD0DP1	0170BMD12V	0.9/5.4

TECH INFO

Bulb: 12 Volt (Included)
Projection Overall: 4-3/4"
Screw Size: #10



Fig. 0170BMD

NOTE: See Page 61 for Spare Parts Ordering Information

HORIZONTAL & VERTICAL SURFACE MOUNT MASTHEAD LIGHTS

1

REPLACEMENT
A-16
ONLY



Fig. 0964
Horizontal Mount

Fig. 0964 Masthead Light - Certified For Replacement Use
Only On Sail or Power Driven Vessels Under
12 Meters (39.4 ft.) in Length

CONSTRUCTION:

- Chrome Plated Brass or Stainless Steel Top
- Black Polymer Base

ORDERING INFO			TECH INFO
Finish	Dealer Pkg. - 5 Cards 1 Pc. per Card	Ship Wt. Carton Lbs. Dealer Pkg.	Bulb: 12 Volt (Included) O.D. Base: 2-3/8" Screw Size: #4 2 Mile Visibility Vertical Ht.: 7/8"
Chrome Brass	0964DPOCHR	1.1	
Stainless Steel	0964DPOSTS	1.1	

SPARE PARTS ORDERING INFORMATION

Base with Socket Assembly: 0135. Bulbs (2 per card): 0071DPOCLR.
Old Style (Open Top) Lens: 0281DPAWHT. New Style (Closed Top) Lens: 0295DPOWHT.

USCG

3
nm



Fig. 1331
Vertical Mount

Fig. 1331 Masthead Light - Certified For Use On Sail or
Power Driven Vessels Under 20 Meters (65.6 ft.) in Length

CONSTRUCTION:

- Chrome Plated Zinc Alloy with Black Polymer Base

ORDERING INFO			TECH INFO
Dealer Pkg. 5 Cards 1 Pc. per Card	OEM Bulk Pkg. 50 Pcs.	Ship Wt. Carton Lbs. DP/OEM Bulk	Bulb: 12 Volt (Included) Length: 3-1/4" Width: 1-1/2" Screw Size: #4
1331DPOCHR	1331000CHR	1.7/13.0	

SPARE PARTS ORDERING INFORMATION

Bulbs (2 per card): 0071DPOCLR. Lenses (2 per card): 0278DPOWHT.

USCG

3
nm



Fig. 1178

Fig. 1178 Masthead Light

Certified For Use On Sail or Power Driven Vessels
Under 20 Meters (65.6 ft.) in Length

CONSTRUCTION:

- Black or White Polymer and Chrome Plated Zinc Alloy Top
with Black or White Polymer Base

ORDERING INFO					TECH INFO
Color	Volts	Dealer Pkg. 5 Cards 1 Pc. per Card	OEM Bulk Pkg. 50 Pcs.	Ship Wt. Carton Lbs. DP/OEM Bulk	Bulb: 12 or 24 Volt (Included) Screw Size: #8 Vertical Ht.: 3-1/4"
Black	12	1178DPOCHR	1178000CHR	1.7/13.5	
White	12	_____	1178000WHT	1.7/13.5	
Black	24	1178DP2CHR	1178002CHR	1.7/13.5	
White	24	_____	1178002WHT	1.7/13.5	

SPARE PARTS ORDERING INFORMATION

12V Bulbs (2 per card): 0071DPOCLR. 24V Bulbs (2 per card): 0072DP1CLR.
Lenses (2 per card): 0278DPOWHT. Top Cap and Screw: 1158DPOBLK.

NOTE: Fig. 1178 meets USCG requirements for 12 and 24 volt applications. Fig. 1331 meets USCG requirements for 12-volt applications only. All of the above can also be used as 24-volt A.B.Y.C. A-16 certified lights on boats built prior to 11/1/03. To use as 24-volt lights while maintaining A-16 certification, replace the bulbs provided with Cat. No. 0072DP1CLR 24-volt bulbs. Contact us for 24 volt applications for new construction.

VERTICAL MOUNT STERN LIGHTS

Fig. 0170 Stern Light - Certified For Use On Sail or Power Driven Vessels Under 20 Meters (65.6 ft.) in Length (12 or 24 Volts)



CONSTRUCTION OPTIONS:

- Chrome Plated Brass Top with Black Polymer Base
- All Black Polymer
- All White Polymer

Note: Old 12 volt 0120 Series lights are superseded by the 0170 Series



Fig. 0170MSN



Fig. 0170BSN



Fig. 0170WSN

Note:
See Pages 60 & 61 for Complete Series and Spare Parts Ordering Information.



ORDERING INFO			
Finish	Dealer Pkg. 5 Cards 1 Pc. per Card	Standard Pkg. 1 Pc.	Ship Wt. Carton Lbs. DP/Std. Pkg.
12 Volt			
Chrome	0170MSNDP1	0170MSN12V	0.5/2.4
Black	0170BSNDP1	0170BSN12V	0.5/2.4
White	0170WSNDP1	0170WSN12V	0.5/2.4
24 Volt			
Chrome	0170MSNDP2	0170MSN24V	0.5/2.4
Black	0170BSNDP2	0170BSN24V	0.5/2.4
White	0170WSNDP2	0170WSN24V	0.5/2.4

0170 TECH INFO
• Projection Overall: 2-1/2"
• Height Overall: 3-5/8"
• Width: 4-1/8"
• Screw Size #10
• 12 or 24 Volt Bulb Included

LED Versions Available. See Page 59.



Fig. 0939 Stern Light - Certified For Use on Sail or Power Driven Vessels Under 20 Meters (65.6 ft.) In Length



CONSTRUCTION:

- Chrome Plated Brass or Stainless Steel Top
- Black Polymer Base
- Flush Mount



Fig. 0939

ORDERING INFO				TECH INFO
Finish	Dealer Pkg. 5 Cards 1 Pc. per Card	OEM Bulk Pkg. 20 Pcs.	Ship Wt. Carton Lbs. DP/OEM Bulk	Bulb: 12 Volt (Included) Dimensions: 5-3/16" x 3-3/8" Depth: 1-1/2" Screw Size: #8
Chrome Brass	0939DP112V	093900112V	2.2/7.0	
Stainless Steel	0939DP1STS	0939001STS	2.2/7.0	

SPARE PARTS ORDERING INFORMATION

Bulbs (2 per card): 0070DPOCLR. Socket Assembly: 0939DP199A.
Lens with O-Ring: 0284DPOCLR. Mounting Flange: 093900099C.

ALSO AVAILABLE IN
MARINIUM
Contact Factory

HORIZONTAL & VERTICAL MOUNT STERN LIGHTS

1 **USCG** **REPLACEMENT**
2 **A-16**
nm **ONLY** **CE**
 Fig. 0965 Fig. 0945



Fig. 0965
Horizontal Mount

Fig. 0945
Vertical Mount

Fig. 0945 Stern Light - Certified For Replacement Use Only on Sail or Power Driven Vessels Under 20 Meters (65.6 ft.) In Length

Fig. 0965 Stern Light - Certified For Use on Sail or Power Driven Vessels Under 20 Meters (65.6 ft.) In Length

CONSTRUCTION:

- Chrome Plated Brass or Stainless Steel Top
- Black Polymer Base

ORDERING INFO					TECH INFO
	Vertical Height Inches	Dealer Pkg. 5 Cards 1 Pc. per Card	OEM Bulk Pkg. 25 Pcs.	Ship Wt. Carton Lbs. DP/OEM Bulk	Bulb: 12 Volt (Included) O.D. Base: 2-3/8" Screw Size: #4 0945 2 Mile Visibility
Finish					
Chrome Brass	7/8	0945DPOCHR	—	1.2/-	
Stainless Steel	7/8	0945DPOSTS	—	1.2/-	
Chrome Brass	3/4	0965DPOCHR	0965000CHR	1.2/4.5	
Stainless Steel	3/4	0965DPOSTS	0965000STS	1.2/4.5	

SPARE PARTS ORDERING INFORMATION

Bulbs (2 per card): 0071DPOCLR. Fig. 0945 Base and Socket Assembly: 0945DP099A. Fig. 0945 Lens: 0074DPOWHT.
 Fig. 0965 (Open Top) Lens: 0281DPAWHT. Fig. 0965 (Closed Top) Lens: 0295DPOWHT.
 Fig. 0965 Base and Socket Assembly: 0135.

NOTE: Fig. 0965 meets the USCG requirements for 12-volt applications. Both Figs. 0945 & 0965 can also be used as 24-volt A.B.Y.C. A-16 certified lights on boats built prior to 11/1/03. To use as 24-volt lights while maintaining A-16 certification, replace the bulbs provided with Cat. No. 0072DP1CLR 24-volt bulbs. Contact us for 24 volt applications on new construction.

USCG **REPLACEMENT**
2 **A-16**
nm **ONLY** **CE**



Fig. 0946
Chrome
Vertical Mount



Fig. 0946
White
Vertical Mount

Fig. 0946 Stern Light - Certified For Use on Sail or Power Driven Vessels Under 20 Meters (65.6 ft.) In Length

ALSO AVAILABLE IN
MARINIUM
 Contact Factory

CONSTRUCTION:

- Chrome Plated Brass, Stainless Steel or White Polymer Bezel
- Black Polymer Base
- Flush Mount

ORDERING INFO				TECH INFO
	Dealer Pkg. 5 Cards 1 Pc. per Card	OEM Bulk Pkg. 25 Pcs.	Ship Wt. Carton Lbs. DP/OEM Bulk	Bulb: 12 Volt (Included) O.D.: 3" Depth: 1" Screw Size: #8
Finish				
Chrome	0946DP112V	094600112V	1.5/5.1	
Stainless	0946DP1STS	0946001STS	1.3/4.7	
White	0946DP1WHT	0946001WHT	1.2/3.9	

SPARE PARTS ORDERING INFORMATION

Bulbs (2 per card): 0070DPOCLR. Socket Assembly: 0946DP199B.
 Lens with O-Ring: 0946DP099A. Mounting Flange: 094600099C.

Fig. 1332 Stern Light - Certified For Replacement Use Only on Sail or Power Driven Vessels Under 20 Meters (65.6 ft.) in Length

CONSTRUCTION:

- Chrome Plated Zinc Alloy with Black Polymer Base

REPLACEMENT
A-16
ONLY **CE**



Fig. 1332
Vertical Mount

ORDERING INFO		TECH INFO
Dealer Pkg. 5 Cards 1 Pc. per Card	Ship Wt. Carton Lbs. Dealer Pkg	Bulb: 12 Volt Included Length: 3-3/4" Width: 1-1/2" Screw Size: #4 2 Mile Visibility
1332DPOCHR	1.7	

SPARE PARTS ORDERING INFORMATION

12V Bulbs (2 per card): 0071DPOCLR.
 Lenses (2 per card): 0278DPOWHT.

NOTE: To Use This Light in an A-16 Certified 24 Volt System, Order Replacement Bulbs (2 per card) Cat. No. 0072DP1CLR

EUROPEAN STYLE L.E.D. NAVIGATION LIGHTS

Fig. 0170 Series L.E.D. Lights

Certified For Use on Sail or Power Driven Vessels Under 20 Meters (65.6 ft.) in Length



1

See Below



CONSTRUCTION:

- Chrome Plated Brass Top with Black Polymer Base
- All Black Polymer
- All White Polymer
- 12 or 24 Volt L.E.D.

L.E.D. Features

- Uses Less than Half the Energy Draw of Standard Lights
- Low Heat
- Long Life



Fig. 0170MSD Fig. 0170MPO



Fig. 0170BSD Fig. 0170BPO



Fig. 0170WSD Fig. 0170WPO



Fig. 0170MMO



Fig. 0170BMO



Fig. 0170WMO



Fig. 0170MSN Fig. 0170MTW



Fig. 0170BSN Fig. 0170BTW



Fig. 0170WSN Fig. 0170WTW

ORDERING INFO

Description	Visibility Arc	12 Volt		24 Volt		Visibility Miles	Ship Wt. Carton Lbs. DP/Std Pkg.
		Dealer Pkg. 1 Card 1 Pc. per Card	Std. Pkg. 1 Pc.	Dealer Pkg. 1 Card 1 Pc. per Card	Std. Pkg. 1 Pc.		
Black Polymer							
Red Side Lit	112-1/2°	0170BPDP3	0170BP012L	0170BPDP4	0170BP024L	2	0.7/0.7
Green Side Light	112-1/2°	0170BSDDP3	0170BSD12L	0170BSDDP4	0170BSD24L	2	0.7/0.7
White Masthead	225°	0170BM0DP3	0170BM012L	0170BM0DP4	0170BM024L	3	0.7/0.7
White Stern Light	135°	0170BSNDP3	0170BSN12L	0170BSNDP4	0170BSN24L	2	0.7/0.7
Yellow Towing	135°	0170BTWDP3	0170BTW12L	0170BTWDP4	0170BTW24L	2	0.7/0.7
Chrome Plated Brass							
Red Side Light	112-1/2°	0170MPDP3	0170MP012L	0170MPDP4	0170MP024L	2	0.8/0.8
Green Side Light	112-1/2°	0170MSDDP3	0170MSD12L	0170MSDDP4	0170MSD24L	2	0.8/0.8
White Masthead	225°	0170MM0DP3	0170MM012L	0170MM0DP4	0170MM024L	3	0.8/0.8
White Stern Light	135°	0170MSNDP3	0170MSN12L	0170MSNDP4	0170MSN24L	2	0.8/0.8
Yellow Towing	135°	0170MTWDP3	0170MTW12L	0170MTWDP4	0170MTW24L	2	0.8/0.8
White Polymer							
Red Side Light	112-1/2°	0170WPDP3	0170WP012L	0170WPDP4	0170WP024L	2	0.7/0.7
Green Side Light	112-1/2°	0170WSDDP3	0170WSD12L	0170WSDDP4	0170WSD24L	2	0.7/0.7
White Masthead	225°	0170WM0DP3	0170WM012L	0170WM0DP4	0170WM024L	3	0.7/0.7
White Stern Light	135°	0170WSNDP3	0170WSN12L	0170WSNDP4	0170WSN24L	2	0.7/0.7
Yellow Towing	135°	0170WTWDP3	0170WTW12L	0170WTWDP4	0170WTW24L	2	0.7/0.7

TECH INFO

12 or 24 Volt L.E.D.
Height Overall: 3-5/8"
Width Overall: 4-1/8"
Proj. Overall: 2-1/2"
Screw Size: #10

0170 SERIES



Side View



Top View

EUROPEAN STYLE NAVIGATION LIGHTS

1

USCG USCG



See Page 61

Fig. 0170 Series Lights

Certified For Use on Sail or Power Driven Vessels Under 20 Meters (65.6 ft.) in Length (12V or 24V)

CONSTRUCTION:

- Chrome Plated Brass Top, Black Polymer Base
- All Black Polymer
- All White Polymer
- 12 or 24 Volt Bulb Included

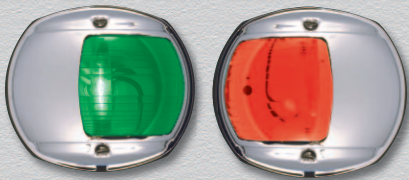

Fig. 0170MSD

Fig. 0170MPO



Fig. 0170BSD

Fig. 0170BPO



Fig. 0170WSD

Fig. 0170WPO

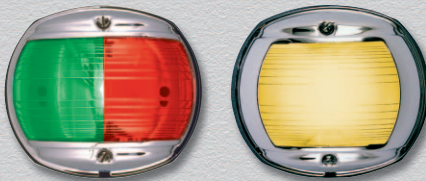

Fig. 0170MB0*

Fig. 0170MTW

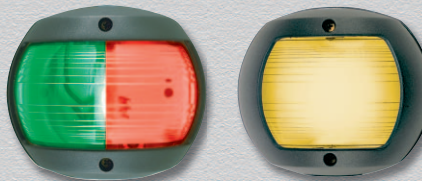

Fig. 0170BB0*

Fig. 0170BTW



Fig. 0170WB0*

Fig. 0170WTW



Fig. 0170MSN

Fig. 0170MMO

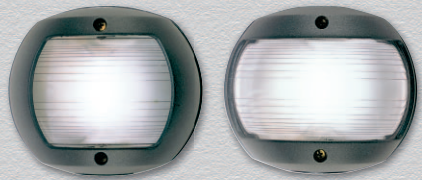

Fig. 0170BSN

Fig. 0170BMO



Fig. 0170WSN

Fig. 0170WMO



Fig. 0170SWB



0170 Series



Side View



Top View



Fig. 0170BMD

* Certified for A-16 replacement use only on boats built prior to 11/1/03.

Fig. 0170 Series Lights

TECH INFO					
12 & 24 Volt	Ht. Overall Inches	Proj. Overall Inches	Width Inches	Screw Size	Ship Wt. Carton Lbs. Std. Pkg./DP/OEM Bulk
0170 Chrome Series	3-5/8	2-1/2	4-1/8	10	0.5/2.4/-
0170 Black Polymer Series	3-5/8	2-1/2	4-1/8	10	0.5/2.3/-
0170 White Polymer Series	3-5/8	2-1/2	4-1/8	10	0.5/2.3/-
0170BMD	7	4-3/4	4-1/8	10	0.9/5.4/-
0170SWB	5-1/8*	—	2-1/2	8	-/1.7/10.0

*Vertical Height - 3-3/4 Inches.

ORDERING INFORMATION

Description	Visibility Arc	12 Volt	12 Volt	24 Volt	24 Volt	Visibility Miles
		Dealer Pkg. 5 Cards 1 Pc. per Card	Std. Pkg. 1 Pc.	Dealer Pkg. 5 Cards 1 Pc. per Card	Std. Pkg. 1 Pc.	
Black Polymer						
Bi-Color Light*	225°	0170BBODP1	—	0170BBODP2	—	2
Red Side Light	112-1/2°	0170BP0DP1	0170BP012V	0170BP0DP2	0170BP024V	2
Green Side Light	112-1/2°	0170BSDDP1	0170BSD12V	0170BSDDP2	0170BSD24V	2
White Masthead Light	225°	0170BMODP1	0170BMO12V	0170BMODP2	0170BMO24V	3
White Stern Light	135°	0170BSNDP1	0170BSN12V	0170BSNDP2	0170BSN24V	2
Yellow Towing Light	135°	0170BTWDP1	0170BTW12V	0170BTWDP2	0170BTW24V	2
Chrome Plated Brass						
Bi-Color Light*	225°	0170MB0DP1	—	0170MB0DP2	—	2
Red Side Light	112-1/2°	0170MPODP1	0170MPO12V	0170MPODP2	0170MPO24V	2
Green Side Light	112-1/2°	0170MSDDP1	0170MSD12V	0170MSDDP2	0170MSD24V	2
White Masthead Light	225°	0170MMODP1	0170MMO12V	0170MMODP2	0170MMO24V	3
White Stern Light	135°	0170MSNDP1	0170MSN12V	0170MSNDP2	0170MSN24V	2
Yellow Towing Light	135°	0170MTWDP1	0170MTW12V	0170MTWDP2	0170MTW24V	2
White Polymer						
Bi-Color Light*	225°	0170WB0DP1	—	0170WB0DP2	—	2
Red Side Light	112-1/2°	0170WPODP1	0170WPO12V	0170WPODP2	0170WPO24V	2
Green Side Light	112-1/2°	0170WSDDP1	0170WSD12V	0170WSDDP2	0170WSD24V	2
White Masthead Light	225°	0170WMODP1	0170WMO12V	0170WMODP2	0170WMO24V	3
White Stern Light	135°	0170WSNDP1	0170WSN12V	0170WSNDP2	0170WSN24V	2
Yellow Towing Light	135°	0170WTWDP1	0170WTW12V	0170WTWDP2	0170WTW24V	2
White All-Round Light						
Black Polymer	360°	0170SWBDP1	0170SWB12V**	0170SWBDP2	—	2
White Polymer	360°	—	0170SWBW12**	—	0170SWBW24	2
Mast/Deck Spreader Lt.	225°	0170BMDDP1	0170BMD12V	—	—	3

* Certified for A-16 Replacement Use Only on Vessels Built Prior to 11/1/03.

** OEM Bulk Pkg. - 50 pcs.

Note: 12 volt 0120 Series lights are superseded by the 0170 Series

SPARE PARTS ORDERING INFORMATION

Halogen Bulb for Deck Spreader Light: 006812V20W.
Bulbs (2 per card) for 0170 SWB (12 Volt): 0337012DP.
Bulb (1 per card), for 0170SWB (24 Volt): 0337014DP.

Bulbs (2 per card) for 0170 BSN, MSN & WSN (24 Volt): 0067DP1CLR.
Bulbs (2 per card) for 0170 BSN, MSN & WSN (12 Volt): 0069DP0CLR.
Bulbs (2 per card) for All Other 12 Volt 0170's: 0070DP1CLR.
Bulbs (2 per card) for All Other 24 Volt 0170's: 0067DP2CLR.

For Lens and Shield Assembly, Replace the Last Three Digits of the Catalog Number with the Letters "LNS" (e.g., 0170BBOLNS, for a Black Shield and Bi-Color Lens).

EUROPEAN STYLE NAVIGATION LIGHTS

1



Fig. 0200 Series Lights - Certified For Use on Sail or Power Driven Vessels Under 20 Meters (65.6 ft.) in Length

CONSTRUCTION:

- Top Mount**
 - Black or White Polymer with Stainless Steel Mounting Bracket
- Base Mount**
 - Black or White Polymer
- Halyard Mount**
 - Black or White Polymer with Stainless Steel Mounting Hardware

TECH INFO					
	Height Overall Inches	Projection Inches	O.D. Base Inches	Height Lens Inches	Screw Size
Top Mount	4-13/16	3-5/16	—	2-3/4	8
Halyard	7-1/8	—	3-5/16	2-3/4	—
Base Mount	4-7/8	—	3-5/16	2-3/4	10
Double Base Mount	8-5/8	—	3-5/16	2-3/4	10

12, 24 or 32 Volt Bulb Included

Top Mount



Fig. 0200SDT Fig. 0200PTO



Fig. 0200MT0 Fig. 0200BT0



Fig. 0200SNT Fig. 0200TWT

Double Stack Base Mount



Fig. 0200TAB** Fig. 0200GRB

Halyard Mount



Fig. 0200SRH

Base Mount



Fig. 0200SGB Fig. 0200SRB



Fig. 0200PBO Fig. 0200SDB



Fig. 0200SNB Fig. 0200TWB

SPARE PARTS ORDERING INFORMATION

Lens assembly part numbers are determined by replacing the last three digits of the Catalog Number with the letters "LNS" (example: 0200BT0LNS, for a Bi-Color Top Mount Lens Assembly).
 Replacement Bulb Sockets: (single and lower for double) Cat. No. 0093, (upper for double), Cat No. 0095.

Fig. 0200 Series Navigation Lights

ORDERING & TECH INFO - FOR 12 VOLT LIGHTS

	Visibility Arc	Black Dealer Pkg. 5 Cards 1 Pc. per Card	White*** Std. Pkg. 1 Pc per Box	Visibility Miles	Replacement Bulb	Ship Wt. Carton Lbs. D.P./Std. Pkg.
Top Mount						
Bi-Color Light	225°	0200BT0DP1	0200BTOW01	2	037512V25W	4.3/1.0
Red Side Light	112-1/2°	0200PT0DP1	0200PTOW01	2	037512V25W	4.5/1.0
Green Side Light	112-1/2°	0200SDTDP1	0200SDTW01	2	037512V25W	4.5/1.0
White Masthead Light	225°	0200MT0DP1	0200MTOW01	3	037512V25W	4.3/1.0
White Stern Light	135°	0200SNTDP1	0200SNTW01	2	037512V10W	4.5/1.0
Yellow Towing Light	135°	0200TWTDP1	0200TWTW01	2	037512V10W	4.5/1.0
Base Mount						
Bi-Color Light	225°	0200BB0DP1	0200BBOW01	2	037512V25W	4.0/1.0
Red Side Light	112-1/2°	0200PB0DP1	0200PBOW01	2	037512V25W	4.2/1.0
Green Side Light	112-1/2°	0200SDBDP1	0200SDBW01	2	037512V25W	4.2/1.0
White Masthead Light	225°	0200MB0DP1	0200MBOW01	3	037512V25W	4.0/1.0
White Stern Light	135°	0200SNBDP1	0200SNBW01	2	037512V10W	4.2/1.0
Yellow Towing Light	135°	0200TWBDP1	0200TWBW01	2	037512V10W	4.0/1.0
White All-Round Light	360°	0200SWBDP1	0200SWBW01	2	037512V10W	3.8/0.9
Red All-Round Light	360°	0200SRBDP1	0200SRBW01	2	037512V25W	3.8/0.9
Green All-Round Light	360°	0200SGBDP1	0200SGBW01	2	037512V25W	3.8/0.9
Tri-Color Light*	360°	0200TB0DP1**	0200TBOW01**	2	037512V25W	3.8/0.9
Halyard Mount						
White All-Round Light	360°	0200SWHDP1	0200SWHW01	2	037512V10W	5.0/1.2
Red All-Round Light	360°	0200SRHDP1	0200SRHW01	2	037512V25W	5.0/1.2
Green All-Round Light	360°	0200SGHDP1	0200SGHW01	2	037512V25W	5.0/1.2
Double Stack Base Mount						
Tri-Color/White All-Round Light*	360°	0200TABDP1**	0200TABW01**	2/2	037512V25W/10W	6.1/1.5
Masthead/White All-Round Light	360°	0200MABDP1	0200MABW01	3/2	037512V25W/10W	6.2/1.5
Green/Red All-Round Light	360°	0200GRBDP1	0200GRBW01	2/2	037512V25W/25W	6.0/1.5

* For Use on Vessels Under Sail Alone.

** 32V Certified for A-16 Replacement Use Only on Vessels Built Prior to 11/1/03.

*** 12 Volt Only

ORDERING INFO - FOR 24V LIGHTS

For 24V Lights, Replace the "DP1" with "DP2".
For the Replacement Bulb,
Replace the "12V" with "24V" (e.g., 037524V25W).

ORDERING INFO - FOR 32V LIGHTS

For 32V Lights, Replace the "DP1" with "DP3".
For the Replacement Bulb,
Replace the "12V" with "32V" (e.g., 037532V25W).

Figs. 0222 & 0224 - Pipe Mounting Brackets
For Use on All 0200 Series Base Mount Lights

CONSTRUCTION:

- Black or White Polymer
- Screws and Soft Black Mounting Gasket for Mounting Bracket to Light

Fig. 0222 - Flat Mount

Fig. 0224 - Cone Mount



Fig. 0222 - BLK



Fig. 0224 -WHT

ORDERING & TECH INFO

O.D. Overall Inches	Tapped Pipe Size Inches	Black Dealer Pkg. - 5 Bags 1 Pc. per Bag	White Dealer Pkg. - 5 Bags 1 Pc. per Bag	Ship Wt. Carton Lbs. Dealer Pkg
3-5/16	1/2	0222DPOBLK	0222DPOWHT	0.7
3-5/16	1/2	0224DPOBLK	0224DPOWHT	0.7

PERKO®

ALL-ROUND LIGHTS

1



Fig. 0108 All-Round Light

Certified For Use on Power Driven Vessels Under 20 Meters (65.6 ft.) in Length

CONSTRUCTION:

- Black Polymer
- Festoon Type Electrical Socket



Fig. 0108

ORDERING INFO			TECH INFO
Description	Standard Pkg. 1 Pc.	Ship Wt. Carton Lbs. Std. Pkg.	12, 24 or 32 Volt (Bulb Not Included)
White All-Round	0108000BLK*	1.0	Height Overall: 6"
Red All-Round	0108R00BLK	1.0	O.D. Base: 3-1/8"
Green All-Round	0108G00BLK	1.0	Tapped Pipe Size: 1/2"***
			Screw Size: #10

*This Light is Supplied with a Gray Tinted Globe.

**Base Removable for Surface or "Flush" Mounting (See Page 65).

See bottom of the page for bulb and spare parts information.



Figs. 0112B & 0309B All-Round Lights

Certified For Replacement Use Only on Power Driven Vessels Under 20 Meters (65.6 ft.) in Length

CONSTRUCTION:

- Cast Bronze
- Medium Screw Base Type Electrical Socket

Fig. 0112B



Fig. 0309B

ORDERING INFO			TECH INFO
Description	Standard Pkg. 1 Pc.	Ship Wt. Carton Lbs. Std. Pkg.	12 or 32 Volt (Bulb Not Included)
White All-Round	0112B00PLB	2.5	2 Mile Visibility
Red All-Round	0112RB0PLB	2.5	0112
Green All-Round	0112GB0PLB	2.5	Height Overall: 8-3/4"
Yellow All-Round	0112MB0PLB	2.5	O.D. Base: 3-1/8"
			Screw Size: #8
White All-Round	0309B00PLB	1.8	0309
Red All-Round	0309RB0PLB	1.8	Height Overall: 6-1/2"
Green All-Round	0309GB0PLB	1.8	Tapped Pipe Size: 1/2"
Yellow All-Round	0309MB0PLB	1.8	

SPARE PARTS ORDERING INFORMATION FOR Figs. 0108, 0112 & 0309

Globes:

White: 0106000WHT.
 Gray: 0106000GRY.
 Red: 0106000RED.
 Green: 0106000GRN.
 Yellow: 0106000YLW.

Required Bulbs Fig 0108:

12 Volt (2 Per card): 0070DP1CLR.
 24 Volt (2 per Card): 0067DP2CLR.
 32 Volt (2 per Card): 0070DP2CLR.

Required Bulbs Fig 0112 & 0309:

12 Volt for White and Yellow: 0340005FRD.
 12 Volt for Red and Green: 0340006FRD.
 32 Volt for White and Yellow: 0340011FRD.
 32 Volt for Red and Green: 0340012FRD.

Medium Screw Base Socket: 0226. Base and Gasket for Fig. 0108: 0222DP0BLK.

Figs. 0108, 0109, 0110 & 0111

Certified For Use on Power Driven Vessels Under 20 Meters (65.6 ft.) in Length



1

CONSTRUCTION:

- Black or White Polymer



Fig. 0109



Fig. 0110



Fig. 0108



Fig. 0111



Fig. 0109

ORDERING INFO

Description	Visibility Arc	Black		White		Ship Wt. Carton Lbs. Std. Pkg
		Std. Pkg. - 1 Pc.	Std. Pkg. - 1 Pc.	Std. Pkg. - 1 Pc.	Std. Pkg. - 1 Pc.	
Red Side Light	112-1/2°	0109R00BLK	0109R00WHT	2	1.0	
Green Side Light	112-1/2°	0109G00BLK	0109G00WHT	2	1.0	
White Masthead Light	225°	0110000BLK	0110000WHT	3	0.9	
White Stern Light	135°	0111000BLK	0111000WHT	2	0.9	
Yellow Towing Light	135°	0111M00BLK	0111M00WHT	2	0.9	
White All-Round Light*	360°	0108000BLK	_____	2	1.0	
Red All-Round Light	360°	0108R00BLK	_____	2	1.0	
Green All-Round Light	360°	0108G00BLK	_____	2	1.0	

TECH INFO

12, 24 or 32 Volt (Bulb Not Included)
Screw Size: #10
0108
Height Overall: 6"
Height Lens: 5"
Tapped Pipe Size: 1/2"***
O.D. Base: 3-1/8"
0109, 0110 & 0111
Height Overall: 5-1/4"
Height Lens: 4-1/4"

*This Light is Supplied with a Gray Tinted Globe.

**Base Removable for Flush or "Surface" Mounting (See page 64).

SPARE PARTS ORDERING INFORMATION

Replacement Lenses:

112-1/2° Fig. No. 0259H02, Specify RED or GRN.
135° Fig. No. 0269H02, Specify YLW or WHT.
225° Fig. No. 0256H02WHT.
360° Fig. No. 0106000, Specify RED, GRN, GRY or WHT.

Required Bulbs:

For 12 Volt (2 per card): 0070DP1CLR.
For 24 Volt (2 per card): 0067DP2CLR.
For 32 Volt (2 per card): 0070DP2CLR.
Base and Gasket for Fig. No. 0108: 0222DP0BLK.



Fig. 0329 - Meal and Absent Light

CONSTRUCTION:

- Chrome Plated Bronze with Blue & White Glass Lenses
- Double Contact Bayonet Sockets
- Blue Owner Absent Light and White Mealtime Light
- Replaces Blue and White Flags for Use at Night
- For Mounting on Main Starboard Yardarm



ORDERING INFO

Std. Pkg. 1 Pc.	Ship Wt. Carton Lbs. Std. Pkg.
0329000CHR	2.8

TECH INFO

Bulb: 12 or 32 Volt (Not Included)
O.D. Globe: 2-1/2"
Length Overall: 9"
Base Dimensions:
3-3/8" x 1-3/4"
Screw Size: #8

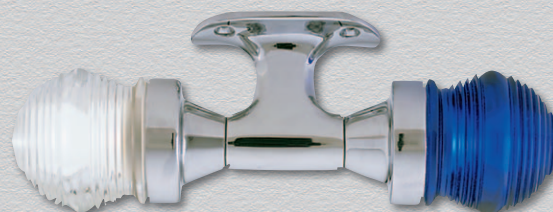

Fig. 0329

SPARE PARTS ORDERING INFORMATION

Required Bulbs For 12 Volt (2 per card): 0337011DP.
Required Bulbs For 32 Volt (1 per card): 0337018DP.
Blue Globe: 0250000BLU.
White Globe: 0250000WHT.
Socket: 0024DP1.

NAVIGATION LIGHTS

1

REPLACEMENT
A-16
ONLY



Figs. 0004F, 0005F, 0007F - Certified For Replacement Use Only on Power Driven Vessels Under 20 Meters (65.6 Ft.) in Length

CONSTRUCTION:

- Galvanized Steel Sheet Metal or Polished Brass
- Bottom Opening, Complete with Mounting Bracket



Fig. 0004F



Fig. 0005F



Fig. 0007F



Fig. 0007MF

ORDERING INFO

Description	Visibility Arc	Galvanized Steel	Polished Brass	Visibility Miles	Ship Wt. Carton Lbs. Std. Pkg.
Side Lights (Pair)	112-1/2°	0004F03GAL	0004F03POL	2	5.0
Red Side Light	112-1/2°	0004RF3GAL	0004RF3POL	2	2.7
Green Side Light	112-1/2°	0004GF3GAL	0004GF3POL	2	2.7
White Masthead Light	225°	0005F03GAL	0005F03POL	3	2.7
White Stern Light	135°	0007F03GAL	0007F03POL	2	2.7
Yellow Towing Light	135°	0007MF3GAL	0007MF3POL	2	2.7

TECH INFO

12 or 32 Volt (Bulb Not Included)
Screw Size: #10
Height Overall: 8-1/2"
Height Lens: 5-1/8"
Required Bulbs:
12 Volt Bulbs (2 per card): 0070DP1CLR.
32 Volt Bulbs (2 per card): 0070DP2CLR.

SPARE PARTS ORDERING INFORMATION

Lenses: 112-1/2° Fig. No. 0259CL3, Specify RED or GRN.
135° Fig. No. 0269CL3, Specify YLW or WHT.
225° Fig. No. 0256CL3WHT.

Mounting Bracket: 0131000GAL or PLB.
Spare Electric Adapter: 0290F03.

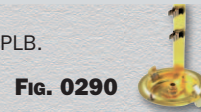

Fig. 0290

REPLACEMENT PARTS

Figs. 0052 & 0276 - Double Contact Bayonet Sockets

Brass, with Wire Leads - Fig. 0276 Tapped for 1/8 Inch Pipe

ORDERING INFO & TECH INFO

Socket Length Inches	Wire Length Inches	Standard Pkg. - 5 Pcs.	Dealer Pkg. - 10 Cards 1 Pc. per Card	Ship Wt. Carton Lbs. Std. Pkg./DP
1	6	—	0052DP	-/0.8
1-1/2	6	0276000	—	0.2/-
2	6	0276002	—	0.2/-

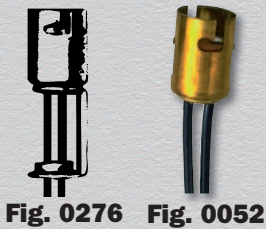

Fig. 0276 Fig. 0052

Fig. 0024 - Double Contact Bayonet Socket

Black Polymer Body

ORDERING INFO & TECH INFO

Length Pigtail Inches	O.D. Inches	Dealer Pkg. - 10 Cards 1 Pc. per Card	Ship Wt. Carton Lbs. Dealer Pkg.
10	3/4	0024DP1	0.7
60	3/4	0024DP2	1.4



Fig. 0024

Fig. 1109 - Single Contact Miniature Bayonet Socket - Brass Body

ORDERING INFO & TECH INFO

Length Pigtail Inches	Length Socket Inches	O.D. Inches	Dealer Pkg. - 10 Cards 1 Pc. per Card	Ship Wt. Carton Lbs. Dealer Pkg.
6	5/8	3/8	1109DP	0.6



Fig. 1109

RAIL MOUNT BASES FOR FOLDING MOUNT LIGHTS

NEW
Item

1

Fig. 1627 - Axial or In-Line Rail Mount Base
For Fold-Down, Adjustable Angle Mounting Bases

CONSTRUCTION:

- Black Polymer
- For Horizontal Mount Bases
- Fits 3/4" Dia. Rails*

FEATURES:

- Fold down base mounts in-line with the direction of the rail allowing the light to fold parallel to the rail.
- Includes 6 screws (4 clamping, 2 mounting)

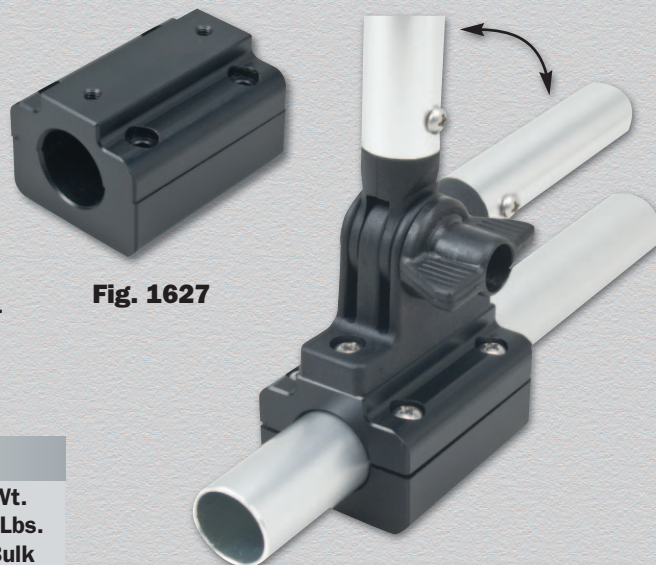

Fig. 1627

ORDERING & TECH INFO

Rail Mount	Base Dimension Inches	OEM Bulk Pkg. 10 Pcs.	Ship Wt. Carton Lbs. OEM Bulk
In-Line	2-3/8 x 1-3/4 x 1-3/8	1627000BLK	2.0

Fig. 1628 - Perpendicular Rail Mount Base
For Fold-Down, Adjustable Angle Mounting Bases.

CONSTRUCTION:

- Black Polymer
- For Horizontal Mount Bases
- Fits 3/4" Dia. Rails*

FEATURES:

- Fold down base mounts perpendicular to the direction of the rail allowing the light to fold perpendicular to the rail direction.
- Includes 2 mounting/clamping screws.



Fig. 1628

ORDERING & TECH INFO

Rail Mount	Base Dimension Inches	OEM Bulk Pkg. 10 Pcs.	Ship Wt. Carton Lbs. OEM Bulk
Perpendicular	2-5/16 x 3/4 x 1-1/4	1628000BLK	2.0

* Other rail tubing diameters available on special order.
Note: Pole light and folding base not included.

REPLACEMENT BASES FOR FOLDING WINDSHIELD MOUNT LIGHTS

1

Figs. 1052 & 1054 - Fold-Down, Adjustable Angle Mounting Base

with Polymer Adapter for "V" or Flat Mounting Surfaces
Complete with Knob and End Plug



Fig. 1052
Horizontal



Fig. 1054
Vertical

Figs. 1052, 1052A, 1054 & 1054A

CONSTRUCTION:

- Chrome Plated Zinc Alloy & Black Polymer

Figs. 1052/1054

Does Not Contain Notch for Through Base Wiring

Fig. 1052 - Horizontal Mount, Fits Figs. 1134 & 1634

Fig. 1054 - Vertical Mount, Fits Figs. 1137 & 1637

Figs. 1052A/1054A

Contains Notch for Through Base Wiring

Fig. 1052A - Horizontal Mount, Fits Figs. 1181 & 1281

Fig. 1054A - Vertical Mount, Fits Figs. 1184 & 1284

Figs. 1052B & 1054B

CONSTRUCTION:

- Black Polymer

Figs. 1052B/1054B

Contains Notch for Through Base Wiring

Universal Mounting Base Fits all Fold Down Series Poles

Fig. 1052B - Horizontal Mount

Fig. 1054B - Vertical Mount



Fig. 1052A
Horizontal



Fig. 1054A
Vertical



Fig. 1052B
Horizontal



Fig. 1054B
Vertical

ORDERING & TECH INFO

	Through Base Wiring	Mount	Length Overall Inches	Width Overall Inches	Dealer Pkg. 5 Cards 1 Pc. per Card	Ship Wt. Carton Lbs. Dealer Pkg.
Chr. Plated Zinc Alloy	No	Horiz.	2	1-1/2	1052DPOCHR	1.8
Chr. Plated Zinc Alloy	No	Vertical	2-1/4	5/8	1054DPOCHR	1.8
Chr. Plated Zinc Alloy	Yes	Horiz.	2	1-1/2	1052DPACHR	1.8
Chr. Plated Zinc Alloy	Yes	Vertical	2-1/4	5/8	1054DPACHR	1.8
Black Polymer	Yes	Horiz.	2	1-1/2	1052DPBBLK	1.2
Black Polymer	Yes	Vertical	2-1/4	5/8	1054DPBBLK	1.2

Fig. 1058 - Fold-Down, Adjustable Angle Mounting Base

CONSTRUCTION:

- Chrome Plated Zinc Alloy and Black Polymer
- Quick Release Handle
- Graduated Adjustment Increments

For Use on Pontoon Boats, Square Rails or Flat Mounting Surfaces



Fig. 1058
Vertical

ORDERING & TECH INFO

	Through Base Wiring	Mount	Base Dimension Inches	Dealer Pkg. 5 Cards 1 Pc. per Card	Ship Wt. Carton Lbs. Dealer Pkg.
Chr. Plated Zinc Alloy	No	Vertical	2-1/4 x 5/8	1058DPOCHR	1.8

REPLACEMENT BASES FOR PLUG-IN & TELESCOPING POLE LIGHTS

Figs. 1123-99A & 1124-99A - Plug-In Type Mounting Bases

CONSTRUCTION:

- Chrome Plated Zinc Alloy Mounting Base
- Black Polymer Waterproof Screw on Cover for Base
- Polymer Adapter for "V" or Flat Mount

Fig. 1123-99A - Horizontal Mount

Fits Figs. 1123 & 1273 Series Masthead All-Round Lights

Fig. 1124-99A - Vertical Mount

Fits Figs. 1124 & 1274 Series Masthead All-Round Lights



Fig. 1123-99A



Fig. 1124-99A



1

ORDERING & TECH INFO

Dimensions Bracket Inches	Dealer Pkg. - 5 Cards 1 Pc. per Card	Ship Wt. Carton Lbs. Dealer Pkg.
2-1/4 x 3/4	1123DP099A	2.4
3/4 x 2-1/4	1124DP099A	2.5



Fig. 1209-99A (2 Pin) - Plug in Type Base

Fig. 1125-99A (3 Pin) - Plug in Type Base

CONSTRUCTION:

- Chrome Plated Brass with Screw on Cap and Retainer

Fig. 1125-99A - Fits Fig. 1125 Masthead All-Round Light

Fig. 1209-99A - Fits Fig. 1209 Series White All-Round Lights



Figs. 1125-99A
& 1209-99A

ORDERING & TECH INFO

Base Dimensions Inches	Dealer Pkg. - 5 Cards 1 Pc. per Card	Tube Angle Degrees	Ship Wt. Carton Lbs. Dealer Pkg.
3-3/8 x 2-1/4	1125DP099A	16	2.2
3-3/8 x 2-1/4	1209DP099A	16	2.1



Figs. 1059T00 & 1060TB0 Locking Collar, Telescoping Type Base

CONSTRUCTION:

- Black Polymer and Chrome Plated Zinc Alloy
- Black Polymer Insert - (Fig. 1060TB0)

Fig. 1059T00 - Fits Figs. 1311 & 1611 Series

Fig. 1060TB0 - Fits Fig. 1411 Series



Fig. 1059T00
16° Rake

Locking Collar is Included with Base To Allow Interchangeability with Discontinued Style Bases

ORDERING & TECH INFO

Base Dimensions Inches	Insert Type	Dealer Pkg. 5 Cards 1 Pc. per Card	Tube Angle Degrees	Ship Wt. Carton Lbs. Dealer Pkg.
3-3/4 x 1-5/8	None	1059T00DP	16	2.4
3-3/4 x 1-3/4	Black	1060TB0DP	5	2.1



Fig. 1060TB0
5° Rake

POLE LIGHT ACCESSORIES

1



4 Collar Set

Fig. 0030DP0002 - Replacement Collar Set

CONSTRUCTION:

- Black Polymer

The Collar Set is Designed to Provide Collars to Fit All of PERKO's Plug-in Pole Lights



The Collar Set Contains 4 Collars

1 each Locking, Large Threaded, Small Threaded and Screw on Collars

ORDERING INFO & TECH INFO

Description	Dealer Pkg. - 5 Cards 1 Set per Card	Ship Wt. Carton Lbs. Dealer Pkg.
4 Collar Set	0030DP0002	1.1

Fig. 0477 - Pole Storage Clips

CONSTRUCTION:

- Soft Black or White Polymer, U.V. Stabilized
- Fits 3/4 or 7/8 Inch Diameter Tubing



Fig. 0477

ORDERING INFO

TECH INFO

Color	For Pole O.D. Size	Dealer Pkg. 10 Cards 1 Pair per Card	OEM Bulk Pkg. 50 Pairs	Ship Wt. Carton Lbs. DP/OEM Bulk
Black	3/4	0477DP0BLK	0477000BLK	1.5/4.3
White	3/4	0477DP0WHT	0477000WHT	1.5/4.3
Black	7/8	0477DP1BLK	_____	1.7/—

Pole O.D.:
Size 0 = 3/4"
Size 1 = 7/8"
Dimensions:
3/4" x 2-1/4" x 1-5/8"
Screw Size: #10 P.H.



Fig. 1192 - Glare Shield

CONSTRUCTION:

- Black Polymer
- For 3/4 Inch O.D. Tubing
- Can Be Installed Without Removing Light



Fig. 1192

ORDERING INFO & TECH INFO

Dimensions Inches	Dealer Pkg. - 5 Cards 1 Pc. per Card	OEM Bulk Pkg. 25 Pcs.	Ship Wt. Carton Lbs. DP/OEM Bulk
6 x 4-5/16	1192DP0BLK	1192000BLK	1.2/3.5

FOR NAVIGATION LIGHTS ON VESSELS OVER 20 METERS (65.6 FT.) IN LENGTH

Fig. 0337 - Double Contact Bayonet Base Bulb

ORDERING & TECH INFO

Nominal Voltage	Wattage	Amps	Dealer Pkg. 5 cards	Bulbs per Card	Bulb Diameter Inches	Mfr. Lamp No.	Ship Wt. Carton Lbs. Dealer Pkg.
12	7	.58	0337011DP	2	3/4	90	0.4
12	11	.94	0337012DP	2	3/4	1004	0.5
24	15	.63	0337014DP	1	1	306	0.5
32	13	.40	0337018DP	1	3/4	624	0.4



Fig. 0337

Fig. 0375 - Double Contact Bayonet Indexing Base Bulb

ORDERING & TECH INFO

Nominal Voltage	Wattage	Amps	Standard Pkg.- 1 Bulb	Ship Wt. Carton Lbs. Standard Pkg.
12	10	.83	037512V10W	0.1
12	25	2.08	037512V25W	0.1
24	10	.42	037524V10W	0.1
24	25	1.04	037524V25W	0.1
32	10	.31	037532V10W	0.1
32	25	.78	037532V25W	0.1



Fig. 0375

Fig. 0340 - Medium Screw Base Bulb

ORDERING & TECH INFO

Nominal Voltage	Wattage	Amps	Std. Pkg. 6 Bulbs	Type	L.C.L. Inches	Mfr. Lamp No.	Ship Wt. Carton Lbs. Standard Pkg.
12	15	1.25	0340005FRD	A-17	2-3/8	15-A	0.5
12	25	2.08	0340006FRD	A-19	2-9/16	25-A	0.7
32	15	.47	0340011FRD	A-17	2-3/8	15-A	0.5
32	25	.78	0340012FRD*	A-19	2-9/16	25-A	0.4

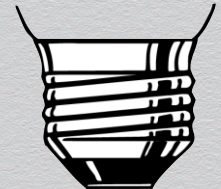

Fig. 0340

* Std. Pkg. 2

Fig. 0338 - Wedge Base Bulb

ORDERING & TECH INFO

Nominal Voltage	Wattage	Amps	Dealer Pkg. - 5 Cards 2 Bulbs per Card	Bulb Dia. Inches	Bulb Length Inches	Ship Wt. Carton Lbs. Dealer Pkg.
12	5	.35	0338DP1CLR	13/32	1-1/16	0.2
12	9	.69	0338DP2CLR	5/8	1-1/2	0.2



Fig. 0338 #2

Fig. 0338 #1

**Figs. 0067, 0069, 0070, 0071 & 0072
Festoon Bulbs - Double Ended**

ORDERING & TECH INFO

Nominal Voltage	Wattage	Amps	Dealer Pkg. - 5 Cards 2 Bulbs per Card	Bulb Dia. Inches	Bulb Length Inches	Ship Wt. Carton Lbs. Dealer Pkg.
12	8	.70	0071DP8CLR	3/8	1-1/8	0.2
12	10	.83	0069DPOCLR	3/8	1-5/8	0.2
12	10	.74	0070DPOCLR	3/8	1-11/16	0.2
12	15	.97	0070DP1CLR	9/16	1-11/16	0.3
12	10	.80	0071DPOCLR	3/8	1-1/8	0.2
24	8	.35	0072DP8CLR	3/8	1-1/8	0.2
24	10	.42	0067DP1CLR	3/8	1-11/16	0.2
24	18	.75	0067DP2CLR	9/16	1-11/16	0.2
24	10	.40	0072DP1CLR	3/8	1-1/8	0.2
32	12	.40	0070DP2CLR	3/8	1-5/8	0.2

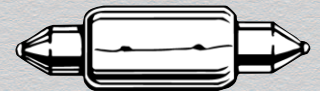

Fig. 0067

Fig. 0069

Fig. 0070

Fig. 0071

Fig. 0072

**Note: Bulbs MUST BE ORDERED in Standard or Dealer Package Quantities Only!
Bulbs for Utility Lights, See Page 127. Bulbs for Navigation Lights Over 20m, See Page 88.**

SPARE LENSES FOR NAVIGATION LIGHTS FOR VESSELS UNDER 20 METERS (65.6 FT.)

1



Fig. 0296



Fig. 0227



Fig. 0283



Fig. 0268

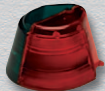

Fig. 0247



Fig. 0241



Fig. 0229



Fig. 0297



Fig. 0259

112-1/2° Lenses for Bi-Color/Tri-Color Lights

ORDERING & TECH INFO

Color	Height Inches	Width Inches	Dealer Pkg. - 5 Cards 1 Lens per Card	Ship Wt. Carton Lbs.
Red/Green	1-5/16	2-1/8	0247DPOLNS*	0.7
Red/Green	1	1-3/4	0283DPALNS*	0.7
Red/Green	1-1/4	1-3/8	0296DPOLNS*	0.5
Red/Green	1-1/4	1-3/8	0297DPOLNS*	0.7
Red/Green	2-1/2	2	0259DPALNS	0.7
Red/Green	1-1/2	1	0268DPOLNS	0.4
Red/Green	7/8	1-5/8 x 13/16	0227DPOLNS*	0.4
Red/Green	1-1/8	3 x 1-5/8	0241DPOLNS*	0.5
Red/Green	1-1/2	2-3/8	0229DPOLNS*	1.0

*One Piece Lens

112-1/2° Lenses for Side Lights

ORDERING & TECH INFO

Color	Height Inches	Width Inches	Dealer Pkg. - 5 Cards 1 Pc. per Card	Ship Wt. Carton Lbs.
Red	1-5/16	2-1/8	0273DPRLNS	0.7
Green	1-5/16	2-1/8	0273DPGLNS	0.7
Red	1-3/4	1-1/16	0277DPRLNS	0.5
Green	1-3/4	1-1/16	0277DPGLNS	0.5
Red	1	1-3/4	0298DPRLNS	0.6
Green	1	1-3/4	0298DPGLNS	0.6
Red	7/8	1-5/8	0228DPRLNS	0.4
Green	7/8	1-5/8	0228DPGLNS	0.4
Red	1-1/2	2-3/8	0232DPRLNS	1.0
Green	1-1/2	2-3/8	0232DPGLNS	1.0
Red/Green	1	1-9/16	0281DPALNS*	0.6
Red/Green	1	2-1/8	0295DPOLNS*	0.7
Red/Green	1-1/4	—	0260DPOLNS*	0.4

*Set of 1 Red and 1 Green Lens

225° Lenses for Masthead Lights

ORDERING & TECH INFO

Color	Height Inches	I.D. Inches	O.D. Inches	Dealer Pkg. - 5 Cards 1 Pc. per Card	Ship Wt. Carton Lbs.
Clear	1	1-9/16	2-3/16	0281DPAWHT	0.4
Clear	1-1/2	1	1-1/4	0278DPOWHT*	0.5
Clear	1-1/2	1	2-1/8	0295DPOWHT	0.7

*2 Pcs. per card

135° Lenses for Stern Lights

ORDERING & TECH INFO

Color	Height Inches	I.D. Inches	O.D. Inches	Dealer Pkg. - 5 Cards 1 Pc. per Card	Ship Wt. Carton Lbs.
Clear	1-1/4	1-9/16	2-3/16	0074DPOWHT	0.7
Clear	1-1/2	1	1-1/4	0278DPOWHT*	0.5
Clear	1-1/4	1-9/16	2-3/16	0281DPAWHT	0.4
Clear	—	—	2	0284DPOCLR**	0.4
Clear	—	—	2-1/8	0295DPOWHT	0.7

*2 Pcs. per card

**Includes O-Ring

360° Lenses for All-Round Lights

ORDERING & TECH INFO

Color	Height Inches	I.D. Inches	O.D. Inches	Dealer Pkg. - 5 Cds 1 Pc. per Cd	Ship Wt. Carton Lbs.
White	3	1-1/2	1-9/16	0201DPOWHT	0.7
Clear	2-1/2	1-11/16	2	0248DPOCLR	0.8
Frosted	2-1/2	1-11/16	2	0248000FRD*	0.7
Clear	3-5/16	3-3/16	—	0261JROCLR*	1.1
Black/Clear	2	—	2-1/4	0238DPOBLK	0.6
Black/Clear	2	—	2-1/4	0239DPOBLK	0.7
Clear	2	—	2-1/4	0239DPOCLR	0.7
Black/Clear	1-1/8	—	3 x 1-5/8	0240DPOLNS	0.5

*0248000FRD 5 per box, 0261JROCLR 1 per box



Fig. 0278



Fig. 0295



Fig. 0281



Fig. 0278



Fig. 0295



Fig. 0281



Fig. 0284



Fig. 0074



Fig. 0239BLK



Fig. 0238



Fig. 0201



Fig. 0248



Fig. 0239CLR



Fig. 0261



Fig. 0248FRD



Fig. 0240

For Navigation Lights on Vessels Over 20 Meters (65.6 ft.) in Length

On March 31, 1977, the U.S. Coast Guard published, in the Federal Register, an amendment to the navigation and navigable water regulations which added a new subchapter DD, (33 CFR 87). This subchapter contains rules implementing and interpreting the International Regulations for Preventing Collisions at Sea, 1972 ('72 COLREGS). The International Regulations for Preventing Collisions at Sea, 1960, were replaced by the '72 COLREGS at 1200 hours, zone time on July 15, 1977. Therefore, all vessels on the high seas must comply with the '72 COLREGS at this time. In addition, with the enactment of the U.S. Inland Navigation Rules Act of 1980, the Inland Rules, Western Rules, and Great Lakes Rules were unified into a single set of requirements. The effective date for this legislation was December 24, 1981 (March 1, 1983 for Great Lakes). Therefore, all vessels must comply with these rules at this time.

Rules 21 and 22 of the '72 COLREGS and the U.S. Inland Navigation Rules give the color and range requirements for various navigation lights. Annex 1 to the '72 COLREGS and the U.S. Inland Navigation Rules gives positioning and technical details for these lights.

U.S. Coast Guard Acceptance of Navigation Lights

All U.S. Registered vessels are subject to either the '72 COLREGS or the U.S. Inland Rules. The U.S. Coast Guard is accepting lights that have passed the UL tests (UL Standard 1104) as meeting the '72 COLREGS and the U.S. Inland Rules for vessels over 20 meters (65.6 ft.) in length. U.S. requirements for smaller vessels are less strict. As the first domestic manufacturer to pass UL 1104, PERKO's lights can be installed on vessels over 20 meters (65.6 ft.) in length. Some models are designed for use on vessels over 20 meters (65.6 ft.) in length, while others are designed for use on vessels 20 meters (65.6 ft.) to 50 meters (164.0 ft.) in length.

A brass tag is permanently affixed to the light indicating the type of light, catalog number, voltage and bulb type to install to meet the visibility requirements. It also states that the light is classified by UL in accordance with the '72 COLREGS. This is the only documentation needed by a vessel for navigation lights to certify light construction compliance with the '72 COLREGS and the Inland Navigation Rules, and eliminates the former "Certificate of Compliance".

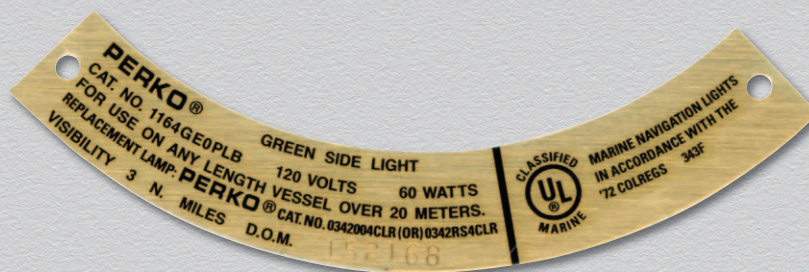

Each Light Has Its Own Serial Number For Identification.

The lights indicated for use on vessels over 20 meters (65.6 ft.) in length have passed UL 1104. The facsimile of the tag shown above is used on our cast bronze lights. Similar rectangular tags are used on other style lights.

Please note that any changes made to PERKO navigation lights, including substitution of bulbs other than those shown in our catalog, instruction sheets, or metal tags (affixed to some lights) will void all certifications and U.S. Coast Guard acceptance.

For the present, the U.S. Coast Guard will not publish a list of UL classified lights. However, field offices have been notified. For more detailed information, consult the complete '72 COLREGS, the U.S. Inland Navigation Rules, and your local U.S. Coast Guard office.

Special Purpose Lights

Other lights (not shown) for use where the vessel is subject to special local requirements are available. Contact PERKO for further information.

DOUBLE LENS L.E.D. NAVIGATION LIGHTS

2



Figs. 1384 - 1388 Series Lights

Certified For Use on Vessels Over 20 Meters (65.6 ft.) in Length

CONSTRUCTION:

- Lightweight, Durable Fiber-Filled Polycarbonate Black Polymer
- Includes Two 3 Foot Lengths of 16/3-SO Cable Through Watertight Terminal Tubes
- Watertight Access Cap for Rebulbing and Cleaning

Upper Lens Section - For "Back-Up" Use

- Removable Incandescent Bulb
- Pre-Wired Medium Prefocus Socket
- 24, 120 & 220 Volt Options, Bulb Not Included
- Rough Service Bulbs Available

Lower Lens Section - Permanently Sealed L.E.D. Chamber

- Long Life, Maintenance Free L.E.D. (120 VAC Only)

ORDERING INFO					TECH INFO
Description	Visibility Arc	Visibility Miles	Cat. No. Std. Pkg. 1 Pc.	Ship Wt. Carton Lbs. Standard Pkg.	
Red Side Light	112-1/2°	3	1384RE0BLK	10.5	Bulb Upper: 24, 120 or 220 Volt (Not Included)
Green Side Light	112-1/2°	3	1384GE0BLK	10.5	
White Masthead Light	225°	6	1385E00BLK	11.2	Lower: 120 VAC L.E.D.
White Stern Light**	135°	3	1386E00BLK	10.0	Mounting Bolt Size: 3/8"
Yellow Towing Light	135°	3	1386ME0BLK	10.0	
White All-Round Light**	360°	3	1387E00BLK	10.0	Height Overall: 18-3/8" (Masthead 20-1/4")
White All-Round Light***	360°	6	1387HE0BLK	10.0	
Red All-Round Light	360°	3	1388RE0BLK	10.0	Height Lens: 6-3/4"
Green All-Round Light	360°	3	1388GE0BLK	10.0	
Yellow All-Round Light	360°	3	1388ME0BLK	10.0	

Special lights to meet local requirements are available upon request.

**These lights are supplied with a Gray Tinted Lens (upper section only)

***For Great Lakes use



Close-up of Sealed L.E.D. Chamber



Fig. 1384
Green Side Light



Fig. 1385
White Masthead



Fig. 1386
Yellow Towing



Fig. 1386
White Stern



Fig. 1384
Red Side Light

IMPORTANT INCANDESCENT BULB DATA- TOP LENS SECTION

To comply with the UL Standard 1104, the lights listed on this page must be used with the Following:

For 24 Volt Use: Cat. No. 0342024CLR,

For 120 Volt Use: Cat. No. 0342004CLR or For "Rough Service" Use Cat. No. 0342RS4CLR

For 220 Volt Use: Cat. No. 0342220CLR

DOUBLE LENS L.E.D. NAVIGATION LIGHTS TECHNICAL INFORMATION

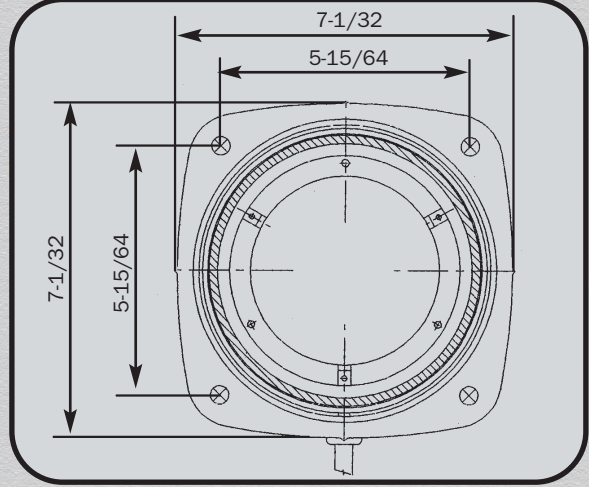
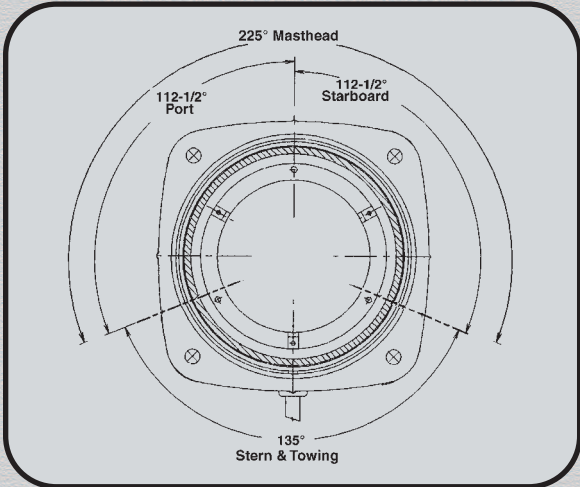

4 - Mounting Holes, for 3/8 inch bolts
Spaced 5-15/64 apart on Center

Figs. 1384, 1386, 1387 & 1388 Series Lights

SPARE PARTS ORDERING INFORMATION

- 1) Access Cap Assembly Including Top Socket
Cat. No. 1363DBLBLK
- 2) Medium Prefocus Socket
Cat. No. 0367
- 3) Bulb Information
24V = 0342024CLR
120V = 0342004CLR & 0342RS4CLR
220V = 0342220CLR

Note: L.E.D. Chamber Permanently Sealed

Fig. 1385 Masthead Light

SPARE PARTS ORDERING INFORMATION

- 1) Access Cap Assembly Including Top Socket
Cat. No. 1363DBLBLK
- 2) Medium Prefocus Socket
Cat. No. 0367
- 3) Bulb Information
24V = 0342024CLR
120V = 0342004CLR & 0342RS4CLR
220V = 0342220CLR

Note: L.E.D. Chamber Permanently Sealed

SINGLE LENS NAVIGATION LIGHTS

2

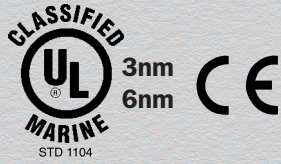

Figs. 1369 - 1374 Series Lights

Certified For Use on Vessels Over 20 Meters (65.6 ft.) in Length

CONSTRUCTION:

- Lightweight But Durable Fiber-Filled Polycarbonate Black Polymer
 - Pre-Wired Medium Prefocus Socket
 - Includes One 3 Foot Length of 16/3-SO Cable Through Watertight Terminal Tubes
- Watertight Access Cap for Rebulbing and Cleaning
 - Rough Service Bulbs are Available

ORDERING INFO					TECH INFO
Description	Visibility Arc	Visibility Miles	Std. Pkg. 1 Pc.	Ship Wt. Carton Lbs. Standard Pkg.	
Red Side Light	112-1/2°	3	1372REOBLK	4.4	Bulb: 24, 120 or 220 Volt (Not Included, see below) Mounting Bolt Size: 3/8" Height Overall: 9-1/4" Height Lens: 6-3/4"
Green Side Light	112-1/2°	3	1372GEOBLK	4.4	
White Masthead Light	225°	6	1373E00BLK	4.3	
White Stern Light*	135°	3	1374E00BLK	4.4	
Yellow Towing Light	135°	3	1374ME0BLK	4.4	
White All-Round Light*	360°	3	1369E00BLK	4.1	
White All-Round Light**	360°	6	1369HE0BLK	4.1	
Red All-Round Light	360°	3	1370RE0BLK	4.1	
Green All-Round Light	360°	3	1370GE0BLK	4.1	
Yellow All-Round Light	360°	3	1370ME0BLK	4.1	

Special lights to meet local requirements are available upon request.

*These lights are supplied with a Gray Tinted Lens

**For Great Lakes use

Fig. 1372
Green Side Light

Fig. 1372
Red Side Light



Fig. 1370
Green
All-Round



Fig. 1370
Red
All-Round



Fig. 1373
White Masthead

Fig. 1370
Yellow
All-Round



Fig. 1374
White Stern



Important Bulb Data

To comply with UL Standard 1104, the lights listed on this page must be used with the following PERKO bulbs:

24 Volt Use Cat. No. 0342024CLR

120 Volt Use Cat. No. 0342004CLR or 0342RS4CLR when a "Rough Service" bulb is required.

220 Volt Use Cat. No. 0342220CLR.

SPARE PARTS ORDERING INFORMATION

Access Cap Assembly: 1363SGLBLK

Medium Prefocus Socket: 0367

Bulb Information:

24V = 0342024CLR

120V= 0342004CLR or 0342RS4CLR

220V= 0342220CLR

Figs. 1364 - 1368 Series Lights

Certified For Use on Vessels Over 20 Meters (65.6 ft.) in Length



CONSTRUCTION:

- Lightweight But Durable Fiber-Filled Polycarbonate Black Polymer
- Pre-Wired Medium Prefocus Socket
- Includes Two 3 Foot Lengths of 16/3-S0 Cable Through Watertight Terminal Tubes
- Watertight Access Cap for Rebulbing and Cleaning
- Rough Service Bulbs are Available

ORDERING INFO				TECH INFO	
Description	Visibility Arc	Visibility Miles	Std. Pkg. 1 Pc.	Ship Wt. Carton Lbs. Standard Pkg.	
Red Side Light	112-1/2°	3	1364REOBLK	7.0	Bulb: 24, 120 or 220 Volt (Not Included) Mounting Bolt Size: 3/8" Height Overall: 17-1/4" Height Lens: 6-3/4"
Green Side Light	112-1/2°	3	1364GEOBLK	7.0	
White Masthead Light	225°	6	1365E0OBLK	6.9	
White Stern Light*	135°	3	1366E0OBLK	6.9	
Yellow Towing Light	135°	3	1366ME0BLK	6.9	
White All-Round Light*	360°	3	1367E0OBLK	6.3	
White All-Round Light**	360°	6	1367HEOBLK	6.3	
Red All-Round Light	360°	3	1368REOBLK	6.3	
Green All-Round Light	360°	3	1368GEOBLK	6.3	
Yellow All-Round Light	360°	3	1368ME0BLK	6.3	

Special lights to meet local requirements are available upon request

*These lights are supplied with a Gray Tinted Lens

**For Great Lakes use



Fig. 1364
Green Side Light



Fig. 1368
Red All-Round



Fig. 1366
Yellow Towing



Fig. 1367
White All-Round



Fig. 1364
Red Side Light

Important Bulb Data

To comply with UL Standard 1104, the lights listed on this page **must** be used with the following PERKO bulbs:

24 Volt Use Cat. No. 0342024CLR

120 Volt Use Cat. No. 0342004CLR or 0342RS4CLR when a "Rough Service" bulb is required.

220 Volt Use Cat. No. 0342220CLR.

SPARE PARTS ORDERING INFORMATION

Access Cap Assembly Including

Top Socket: 1363DBLBLK

Medium Prefocus Socket: 0367

Bulb Information:

24V = 0342024CLR

120V= 0342004CLR or 0342RS4CLR

220V= 0342220CLR

SINGLE LENS NAVIGATION LIGHTS



Figs. 1169 - 1174 Series Lights

Certified For Use on Vessels Over 20 Meters (65.6 ft.) in Length

CONSTRUCTION:

- Heavy Duty Cast Bronze
- Pre-Wired Medium Prefocus Socket
- 3 Feet of 16/3-SO Cable Through a Watertight Terminal Tube
 - Watertight Access Cap for Rebulbing and Cleaning
 - 120 Volt Only, Bulb Not Included
 - Rough Service Bulbs are Available

ORDERING INFO				TECH INFO	
Description	Visibility Arc	Visibility Miles	Std. Pkg. 1 Pc.	Ship Wt. Carton Lbs. Standard Pkg.	
Red Side Light	112-1/2°	3	1172RE0PLB	12.4	Bulb: 120 Volt (Not Included) Mounting Bolt Size: 3/8" Height Overall: 9-1/4" Height Lens: 6-3/4"
Green Side Light	112-1/2°	3	1172GE0PLB	12.4	
White Masthead Light	225°	6	1173E00PLB	12.4	
White Stern Light*	135°	3	1174E00PLB	12.4	
Yellow Towing Light	135°	3	1174ME0PLB	12.6	
White All-Round Light*	360°	3	1169E00PLB	11.2	
White All-Round Light**	360°	6	1169HE0PLB	11.2	
Red All-Round Light	360°	3	1170RE0PLB	11.2	
Green All-Round Light	360°	3	1170GE0PLB	11.2	
Yellow All-Round Light	360°	3	1170ME0PLB	11.2	

Special lights to meet local requirements are available upon request

*These lights are supplied with a Gray Tinted Lens

**For Great Lakes use

Fig. 1172
Green Side Light



Fig. 1170
Green All-Round



Fig. 1170
Red All-Round

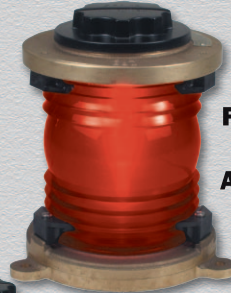

Fig. 1172
Red Side Light



Fig. 1173
White Masthead



Fig. 1170
Yellow All-Round

Fig. 1174
White Stern



IMPORTANT BULB DATA

To comply with UL Standard 1104, the lights listed on this page must use a PERKO Cat. No. 0342004CLR bulb or 0342RS4CLR bulb when a "Rough Service" bulb is required.

Spare Parts Ordering Information

Spare Lenses:

- Red: 0261001RED
- Green: 0261001GRN
- White: 0261001CLR
- Gray: 0261001GRY
- Yellow: 0261001YLW

- Lens Gasket: 1143
- O-Ring for Cap: 1119
- Medium Prefocus Socket: 0367
- Lens Retaining Clip with Bolt: 1133
- Access Cap, O-Ring and Retainer: 1105000BLK

Figs. 1164 - 1168 Series Lights

Certified For Use on Vessels Over 20 Meters (65.6 ft.) in Length

CONSTRUCTION:

- Heavy Duty Cast Bronze
- Pre-Wired Medium Prefocus Socket in Each Compartment
- Two 3 Foot Lengths of 16/3-SO Cable Through a Watertight Terminal Tube
- Watertight Access Cap for Rebulbing and Cleaning
- 120 Volt Only, Bulb Not Included
- Rough Service Bulbs are Available



ORDERING INFO				TECH INFO	
Description	Visibility Arc	Visibility Miles	Std. Pkg. 1 Pc.	Ship Wt. Carton Lbs. Standard Pkg.	
Red Side Light	112-1/2°	3	1164REOPLB	22.5	Bulb: 120 Volt (Not Included) Mounting Bolt Size: 3/8" Height Overall: 17-1/4" Height Lens: 6-3/4"
Green Side Light	112-1/2°	3	1164GEOPLB	22.5	
White Masthead Light	225°	6	1165E00PLB	21.5	
White Stern Light*	135°	3	1166E00PLB	22.3	
Yellow Towing Light	135°	3	1166ME0PLB	22.4	
White All-Round Light*	360°	3	1167E00PLB	20.0	
White All-Round Light**	360°	6	1167HE0PLB	20.0	
Red All-Round Light	360°	3	1168RE0PLB	20.0	
Green All-Round Light	360°	3	1168GE0PLB	20.0	
Yellow All-Round Light	360°	3	1168ME0PLB	20.0	

Special lights to meet local requirements are available upon request

*These lights are supplied with a Gray Tinted Lens

**For Great Lakes use



Fig. 1164
Green Side Light

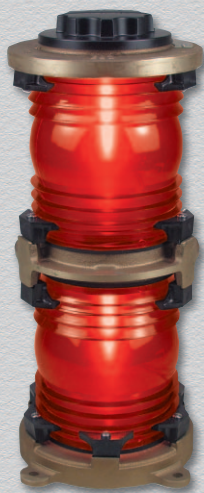

Fig. 1168
Red All-Round



Fig. 1166
Yellow Towing



Fig. 1167
White All-Round

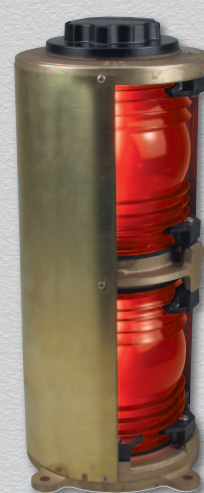

Fig. 1164
Red Side Light

IMPORTANT BULB DATA

To comply with UL Standard 1104, the lights listed on this page must use a PERKO Cat. No. 0342004CLR bulb or 0342RS4CLR bulb when a "Rough Service" bulb is required.

Spare Parts Ordering Information

Spare Lenses:

- Red: 0261001RED
- Green: 0261001GRN
- White: 0261001CLR
- Gray: 0261001GRY
- Yellow: 0261001YLW

- Lens Gasket: 1143
- O-Ring for Cap: 1119
- Dual Medium Prefocus Socket Assembly: 0303
- Lens Retaining Clip with Bolt: 1133
- Access Cap, O-Ring and Retainer: 1105000BLK

L.E.D. NAVIGATION LIGHTS - BLACK

2



See Below



Figs. 1377 - 1380 Series L.E.D. Navigation Lights

Certified For Use on Vessels 20 Meters (65.6 ft.) to 50 Meters (164.0 ft.) in Length

CONSTRUCTION:

- Black Polymer
- Pre-Wired with 3 Feet of 16/3-SO Cable
- Sealed Cap
- No User Serviceable Parts Inside

NEW Item
Available by
Dec. 2010

ORDERING INFO

Description	Visibility Arc	Visibility Miles	Black Polymer Std. Pkg. 1 Pc.	Ship Wt. Carton Lbs. Standard Pkg.
Red Side Light	112-1/2°	2	1377RA0BLK	3.2
Green Side Light	112-1/2°	2	1377GA0BLK	3.2
White Masthead Light	225°	5	1378A00BLK	3.1
White Stern Light	135°	2	1379A00BLK	3.2
Yellow Towing Light	135°	2	1379MA0BLK	3.2
White All-Round Light	360°	2	1380A00BLK	3.0
White All-Round Light**	360°	5	1380HA0BLK	3.0
Red All-Round Light	360°	2	1380RA0BLK	3.0
Green All-Round Light	360°	2	1380GA0BLK	3.0
Yellow All-Round Light	360°	2	1380MA0BLK	3.0

TECH INFO

- L.E.D.: Operates on 12 or 24 Volt D.C. System
- Screw Size: 1/4"
- Height Overall: 7-1/2"
- Height Lens: 4-1/2"

Special lights to meet local requirements are available upon request

**For Great Lakes use



Fig. 1377
Red & Green Side Lights



Fig. 1378
Masthead Light



Fig. 1379
Stern Light



Fig. 1380
All-Round Light

L.E.D. NAVIGATION LIGHTS - WHITE

Figs. 1377 - 1380 Series L.E.D. Navigation Lights

Certified For Use on Vessels 20 Meters (65.6 ft.) to 50 Meters (164.0 ft.) in Length

CONSTRUCTION:

- White Polymer
- Pre-Wired with 3 Feet of 16/3-S0 Cable
- Sealed Cap
- No User Serviceable Parts Inside



2

See Below



ORDERING INFO

TECH INFO

Description	Visibility Arc	Visibility Miles	White Polymer Std. Pkg. 1 Pc.	Ship Wt. Carton Lbs. Standard Pkg.
Red Side Light	112-1/2°	2	1377RAOWHT	3.2
Green Side Light	112-1/2°	2	1377GAOWHT	3.2
White Masthead Light	225°	5	1378A00WHT	3.1
White Stern Light	135°	2	1379A00WHT	3.2
Yellow Towing Light	135°	2	1379MAOWHT	3.2
White All-Round Light	360°	2	1380A00WHT	3.0
White All-Round Light**	360°	5	1380HAOWHT	3.0
Red All-Round Light	360°	2	1380RAOWHT	3.0
Green All-Round Light	360°	2	1380GAOWHT	3.0
Yellow All-Round Light	360°	2	1380MAOWHT	3.0

- L.E.D.: Operates on 12 or 24 Volt D.C. System
- Screw Size: 1/4"
- Height Overall: 7-1/2"
- Height Lens: 4-1/2"

Special lights to meet local requirements are available upon request

**For Great Lakes use



Fig. 1377
Red & Green Side Lights



Fig. 1378
Masthead Light

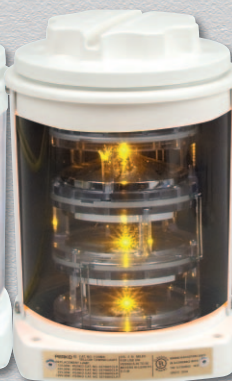

Fig. 1379
Towing Light



Fig. 1379
Stern Light

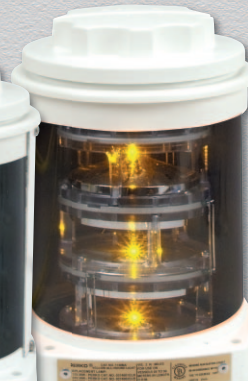

Fig. 1380
Yellow All-Round Light

NAVIGATION LIGHTS - BLACK

2



Figs. 1127 - 1130 Series Navigation Lights
 Certified For Use on Vessels 20 Meters (65.6 ft.)
 to 50 Meters (164.0 ft.) in Length

CONSTRUCTION:

- Black Polymer
- Pre-Wired Double Contact Socket and 3 Feet of 16/3-SO Cable
- Watertight Access Cap for Rebulbing and Cleaning

ORDERING INFO

Description	Visibility Arc	Visibility Miles	Black Polymer Std. Pkg. 1 Pc.	Ship Wt. Carton Lbs. Standard Pkg.
Red Side Light	112-1/2°	2	1127RAOBLK	2.7
Green Side Light	112-1/2°	2	1127GAOBLK	2.7
White Masthead Light	225°	5	1128A00BLK	2.6
White Stern Light*	135°	2	1129A00BLK	2.7
Yellow Towing Light	135°	2	1129MAOBLK	2.7
White All-Round Light*	360°	2	1130A00BLK	2.5
White All-Round Light**	360°	5	1130HAOBLK	2.5
Red All-Round Light	360°	2	1130RAOBLK	2.5
Green All-Round Light	360°	2	1130GAOBLK	2.5
Yellow All-Round Light	360°	2	1130MAOBLK	2.5

TECH INFO

Bulb: 12, 24, 32 or 120 Volt (Not Included)

Screw Size: 1/4"
 Height Overall: 7-1/2"
 Height Lens: 4-1/2"

Special lights to meet local requirements are available upon request

*These lights are supplied with a Gray Tinted Lens

**For Great Lakes use



Fig. 1127
Red & Green Side Lights



Fig. 1128
Masthead Light



Fig. 1129
Stern Light



Fig. 1130
All-Round Light

IMPORTANT BULB DATA

To comply with UL Standard 1104, the lights listed on this page must use a PERKO Cat. No. 0374 bulb.

SPARE PARTS ORDERING INFORMATION

Lens Assemblies:

- Red: 0249000RED
- Green: 0249000GRN
- White: 0249000CLR
- Gray: 0249000GRY
- Yellow: 0249000YLW

Required Bulbs:

- 12 Volt: 0374001CLR
- 24 Volt: 0374002CLR
- 32 Volt: 0374003CLR
- 120 Volt: 0374004CLR

Other Parts:

- O-Ring for Cap: 1119
- Double Contact Socket: 0134
- Access Cap, O-Ring and Retainer: 1105000BLK

Figs. 1127 - 1130 Series Navigation Lights

Certified For Use on Vessels 20 Meters (65.6 ft.) to 50 Meters (164.0 ft.) in Length



See Below



CONSTRUCTION:

- White Polymer
- Pre-Wired Double Contact Socket and 3 Feet of 16/3-SO Cable
- Watertight Access Cap for Rebulbing and Cleaning

ORDERING INFO					TECH INFO
Description	Visibility Arc	Visibility Miles	White Polymer Std. Pkg. 1 Pc.	Ship Wt. Carton Lbs. Standard Pkg.	
Red Side Light	112-1/2°	2	1127RA0WHT	2.7	Bulb: 12, 24, 32 or 120 Volt (Not Included) Screw Size: 1/4" Height Overall: 7-1/2" Height Lens: 4-1/2"
Green Side Light	112-1/2°	2	1127GA0WHT	2.7	
White Masthead Light	225°	5	1128A00WHT	2.6	
White Stern Light*	135°	2	1129A00WHT	2.7	
Yellow Towing Light	135°	2	1129MA0WHT	2.7	
White All-Round Light*	360°	2	1130A00WHT	2.5	
White All-Round Light**	360°	5	1130HA0WHT	2.5	
Red All-Round Light	360°	2	1130RA0WHT	2.5	
Green All-Round Light	360°	2	1130GA0WHT	2.5	
Yellow All-Round Light	360°	2	1130MA0WHT	2.5	

Special lights to meet local requirements are available upon request

*These lights are supplied with a Gray Tinted Lens

**For Great Lakes use



Fig. 1127
Red & Green Side Lights



Fig. 1128
Masthead Light



Fig. 1129
Towing Light



Fig. 1129
Stern Light



Fig. 1130
Yellow All-Round Light

IMPORTANT BULB DATA

To comply with UL Standard 1104, the lights listed on this page must use a PERKO Cat. No. 0374 bulb.

SPARE PARTS ORDERING INFORMATION

Lens Assemblies:

- Red: 0249000RED
- Green: 0249000GRN
- White: 0249000CLR
- Gray: 0249000GRY
- Yellow: 0249000YLW

Required Bulbs:

- 12 Volt: 0374001CLR
- 24 Volt: 0374002CLR
- 32 Volt: 0374003CLR
- 120 Volt: 0374004CLR

Other Parts:

- O-Ring for Cap: 1119
- Double Contact Socket: 0134
- Access Cap, O-Ring and Retainer: 1105000WHT





2

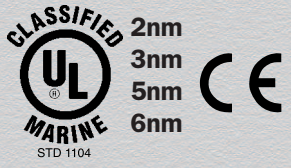

Figs. 1150 - 1154 Series Lights

Certified For Use on Vessel Lengths as Specified Below

CONSTRUCTION:

- Sheet Metal, Preprimed Galvanized Steel
 - Medium Prefocus Socket
- Watertight Terminal Tube for 16/3-SO Cable
- Watertight Access Cap for Rebulbing and Cleaning

ORDERING INFO						TECH INFO
Certified For Use on Vessels 20 Meters (65.6 ft.) to 50 Meters (164.0 ft.) in Length						Bulb: 120 Volt (Not Included) Screw Size: 1/4" Size No. 1 Height Overall: 11-1/2" Height Lens: 6-3/4" Size No. 2 Height Overall: 13-1/2" Height Lens: 7-1/2"
Description	Standard Pkg. 1 Pc.	Visibility Arc	Visibility Miles	Required Bulb	Ship Wt. Carton Lbs. Std. Pkg.	
Red Side Light	1150RE1GAL	112-1/2°	2	0342002CLR	6.1	
Green Side Light	1150GE1GAL	112-1/2°	2	0342002CLR	6.1	
White Masthead Light	1151E01GAL	225°	5	0342003CLR	6.3	
White Stern Light	1152E01GAL	135°	2	0342000CLR	6.1	
Yellow Towing Light	1152ME1GAL	135°	2	0342000CLR	6.1	
White All-Round Light	1153E01GAL	360°	2	0342001CLR	6.5	
Red All-Round Light	1154RE1GAL	360°	2	0342004CLR*	6.7	
Green All-Round Light	1154GE1GAL	360°	2	0342003CLR	6.7	
Yellow All-Round Light	1154ME1GAL	360°	2	0342002CLR	6.7	

Certified For Use on Vessels Over 20 Meters (65.6 ft.) in Length					
Description	Standard Pkg. 1 Pc.	Visibility Arc	Visibility Miles	Required Bulb	Ship Wt. Carton Lbs. Std. Pkg.
Red Side Light	1150RE2GAL	112-1/2°	3	0342004CLR*	10.9
Green Side Light	1150GE2GAL	112-1/2°	3	0342004CLR*	10.9
White Masthead Light	1151E02GAL	225°	6	0342004CLR*	10.0
White Stern Light	1152E02GAL	135°	3	0342002CLR	9.5
White All-Round Light	1153E02GAL	360°	3	0342003CLR	10.6

*0342RS4CLR bulbs can be substituted for 0342004CLR where "Rough Service" bulbs are required



IMPORTANT BULB DATA
 To comply with UL Standard 1104, the lights listed as specified above on this page must use a PERKO Cat. No. 0342 bulb, as specified above.

SPARE PARTS ORDERING INFORMATION

- Lenses:**
- | | | |
|----------|---|--|
| 112-1/2° | 0259 No. 1 or 2, Specify RED or GRN. | Medium Prefocus Socket: 0347A00. |
| 135° | 0269 No. 1 or 2, Specify YLW or WHT. | Access Cap, O-Ring and Retainer: 1105000BLK. |
| 225° | 0256 No. 1 or 2, WHT. | O-Ring for Cap: 1119. |
| 360° | 0261F No. 1 or 2, Specify RED, GRN, YLW or WHT. | Socket Supports: 0341001PLB or 034101APLB. |

Figs. 0004D, 0005D & 0007D Lights

Certified For Use on Vessels 20 Meters (65.6 ft.) to 50 Meters (164.0 ft.) in Length



2

CONSTRUCTION:

- Sheet Metal, Preprimed Galvanized Steel, Polished or Chrome Plated Brass
- Bottom Opening, Complete with Mounting Bracket
- Single Contact Prefocus Socket



Fig. 0004G



Fig. 0004R



Fig. 0005



Fig. 0007



Fig. 0007M

ORDERING INFO

Description	Galvanized Steel	Polished Brass	Chrome Plated Brass	Visibility Arc	Visibility Miles	Required Bulb	Ship Wt. Carton Lbs. Std. Pkg. 1 Pc.
Red Side Light	0004RD3GAL	0004RD3POL	0004RD3CHR	112-1/2°	2	0373003CLR	2.7
Green Side Light	0004GD3GAL	0004GD3POL	0004GD3CHR	112-1/2°	2	0373002CLR	2.7
White Masthead Light	0005D03GAL	0005D03POL	0005D03CHR	225°	5	0373005CLR	2.9
White Stern Light	0007D03GAL	0007D03POL	0007D03CHR	135°	2	0373001CLR	2.8
Yellow Towing Light	0007MD3GAL	0007MD3POL	0007MD3CHR	135°	2	0373002CLR	2.8

TECH INFO

Bulb: 12 Volt
(Not Included)

Height Overall: 8-1/2"
Height Lens: 5-3/16"

IMPORTANT BULB DATA

To comply with UL Standard 1104, the lights listed on this page must use a PERKO Cat. No. 0373 bulb, as specified above.

SPARE PARTS ORDERING INFORMATION

Lenses:

- 112-1/2° Red: 0259CL3RED.
- 112-1/2° Green: 0259CL3GRN.
- 135° White: 0269CL3WHT.
- 135° Yellow: 0269CL3YLW.
- 225° Gray: 0256CL3WHT.

Mounting Bracket: 0131000GAL or 0131000PLB.
Single Contact Prefocus Socket Assembly, Complete with Stand, Bottom Plate and Gasket: 0294003PLB.

PERKO® SPECIAL PURPOSE LIGHTS



2



Fig. 1111

Fig. 1111 - Flashing Yellow Light

For Use on Vessels of Any Length

CONSTRUCTION:

- Sheet Metal, Preprimed Galvanized Steel
 - Medium Prefocus Socket
- Watertight Terminal Tube for 16/3-SO Cable
 - Sealed Flasher Unit
- Watertight Access Cap for Rebulbing and Cleaning

Designed to meet Federal Requirements for Flashing yellow 180° - 225° light for barges, canal boats, etc., that are being pushed ahead or towed along side of a tug boat. For use on 120 volt A.C. only. Federal Requirements for this light are applicable for: inland waters, the Atlantic, Pacific and Gulf coasts, intercoastal waterways and western rivers. Refer to the U.S. Inland Navigation Rules for application, configuration and technical details.

ORDERING INFO					TECH INFO
Standard Pkg. 1 Pc.	Visibility Miles	Visibility Arc	Flashes Per Minute	Ship Wt. Carton Lbs. Std. Pkg.	Bulb: 120 Volt (Not Included)
1111ME1GAL	2	225°	50-70	6.4	Height Overall: 11-1/2" Height Lens: 6-3/4"

IMPORTANT BULB DATA

To comply with Federal Requirements this light must use a PERKO Cat. No. 0342004CLR bulb or 0342RS4CLR bulb when "Rough Service" bulbs are required.

SPARE PARTS ORDERING INFORMATION

Flasher: 0133. Medium Prefocus Socket: 0347A00.
O-Ring for Cap: 1119. Access Cap, O-Ring and Retainer: 1105000BLK.
Lens: 0256001YLV.

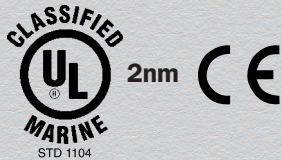

Figs. 0112 & 0309 - "A" Series All Round Lights

Certified For Use on Vessels 20 Meters (65.6 ft.) to 50 Meters (164.0 ft.) in Length

CONSTRUCTION:

- Cast Bronze, Plain or Chrome Plated
- Complete with Double Contact Electrical Socket



Fig. 0112A

ORDERING INFO				TECH INFO
Description	Plain Bronze	Chrome Plated Bronze	Ship Wt. Carton Lbs. Std. Pkg. 1 Pc.	Bulb: 12, 24, 32 or 120 Volt (Not Included)
White All-Round	0112A00PLB	0112A00CHR	2.4	Visibility: 2 Miles
Red All-Round	0112RA0PLB	0112RA0CHR	2.4	Height Overall: 8-3/4"
Green All-Round	0112GA0PLB	0112GA0CHR	2.4	Dia. Base: 3-1/8"
Yellow All-Round	0112MA0PLB	0112MA0CHR	2.4	



Fig. 0309A

ORDERING INFO				TECH INFO
Description	Plain Bronze	Chrome Plated Bronze	Ship Wt. Carton Lbs. Std. Pkg. 1 Pc.	Bulb: 12, 24, 32 or 120 Volt (Not Included)
White All-Round	0309A00PLB	0309A00CHR	1.8	Visibility: 2 Miles
Red All-Round	0309RA0PLB	0309RA0CHR	1.8	Height Overall: 6-1/2"
Green All-Round	0309GA0PLB	0309GA0CHR	1.8	Tapped Pipe Size: 1/2"
Yellow All-Round	0309MA0PLB	0309MA0CHR	1.8	

IMPORTANT BULB DATA

To comply with UL Standard 1104, these lights must use a PERKO Cat. No. 0374 bulb.

SPARE PARTS ORDERING INFORMATION

Lenses:
Red: 0106000RED.
Green: 0106000GRN.
White: 0106000WHT.
Yellow: 0106000YLW.
Double Contact Bayonet Socket: 0276002.

Required Bulbs:
12 Volt: 0374001CLR.
24 Volt: 0374002CLR.
32 Volt: 0374003CLR.
120 Volt: 0374004CLR.

Figs. 0403 & 0412 - Specialty All-Round Lights

Certified For Use on Vessels Over 20 Meters (65.6 ft.) in Length

CONSTRUCTION:

- Cast Bronze
- White, Red, Green or Yellow Lens
- Medium Prefocus Socket



Fig. 0403
Tapped For
Pipe Mount



Fig. 0403



2

Fig. 0403 - Pipe Mount

Fig. 0412 - Hanging Mount

TECH INFO - 120 VOLT ONLY (BULB NOT INCLUDED)

Fig. No.	Ht. Overall Inches	Ht. Lens Inches	Tapped Pipe Size Inches	Visibility Miles
0403	11-1/2	6-3/4	1	3
0412	14	6-3/4	*	3

ORDERING INFO

White	Red	Green	Yellow	Ship Wt. Carton Lbs. Std. Pkg. 1 Pc.
0403E03PLB**	0403RE3PLB	0403GE3PLB	0403ME3PLB	8.6
0412E00PLB**	0412RE0PLB	0412GE0PLB	0412ME0PLB	9.1

*Supplied with watertight terminal tube for 16/3-SO cable.

**These lights are supplied with gray tinted lenses.

IMPORTANT BULB DATA

To comply with UL Standard 1104, these lights must use a PERKO Cat. No. 0342004CLR bulb or 0342RS4CLR bulb when a "Rough Service" bulb is required

SPARE PARTS ORDERING INFORMATION

Gray Lens: 0261001GRY. Yellow Lens: 0261001YLW. Gasket for lens: 1143.
Red Lens: 0261001RED. Green Lens: 0261001GRN. Medium Prefocus Socket: 0367.



Fig. 0412

Fig. 1129 - Panama Canal Blue Steering Light

For Use on Vessels of Any Length

CONSTRUCTION:

- Black Polymer
- Pre-Wired Double Contact Socket with 3 Feet of 16/3-SJO Cable

ORDERING INFO

Std. Pkg. - 1 Pc.	Visibility Arc	Ship Wt. Carton Lbs. Standard Pkg.
1129BA0BLK	135°	2.7

IMPORTANT BULB DATA

To comply with Panama Canal Requirements this light must use a PERKO Fig. No. 0374 bulb.

SPARE PARTS ORDERING INFORMATION

Bulbs
12 Volt: 0374001CLR. Lens: 0249000BLU.
24 Volt: 0374002CLR. O-Ring for Cap: 1119.
32 Volt: 0374003CLR. Double Contact Socket: 0134.
120 Volt: 0374004CLR. Polymer Access Cap, O-Ring and Retainer: 1105000BLK.

TECH INFO

Bulb: 12, 24, 32 or
120 Volt
(Not Included)
Height Overall: 7-1/2"
Height Lens: 4-1/4"



Fig. 1129



Fig. 0454 - Pipe Mount All-Round White Whistle Light

Certified For Use on Vessels Over 20 Meters (65.6 ft.) in Length

CONSTRUCTION:

- Cast Bronze
- Medium Prefocus Socket



Fig. 0454E
Tapped For
Pipe Mount



Fig. 0454

ORDERING INFO

Std. Pkg. - 1 Pc.	Ship Wt. Carton Lbs. Standard Pkg.	Visibility Miles
0454E00PLB	8.6	5

SPARE PARTS ORDERING INFORMATION

Bulb: 0342004CLR. Lens or Cover Gasket: 1143.
Lens: 0261001CLR. Medium Prefocus Socket: 0367.

TECH INFO

Bulb: 120 Volt
(Not Included)
Height Overall: 11-1/2"
Height Lens: 6-3/4"
Tapped Pipe Size: 1"



15 Inch Housing - Fig. 9304 (500 Watt), 110 or 220 VAC Power Supply
19 Inch Housing - Fig. 9854 (1600 Watt), 220 or 440 VAC Power Supply

XR Series Xenon Searchlights are designed and manufactured to meet the demanding needs of commercial marine applications. The short arc Xenon filled lamps produce an extremely bright and very white light which can be focused in the pilothouse into a narrow long range beam. The heavy duty head of the 1,600 watt light is a marine grade aluminum casting with integral cooling fins to assure cool operation at high output levels. The cast marine aluminum yoke & base are equally rugged. High quality Timkin bearings provide for smooth 380° rotation.

The XR Series model 9854 is available manually controlled with a traditional lever gear control system or remotely controlled with a distant electric control system. In addition, an optional heating capability is available to assure trouble free operation in areas of the world prone to icing conditions. The XR Series model 9854 searchlight can be operated continuously at 1,600 watts for maximum brightness providing in excess of 100,000,000 candlepower and up to 5.5 mile (IES Handbook) range.

The XR Series model 9304 searchlight can be operated continuously at 500 watts for a maximum brightness of 35,000,000 candlepower and over 3 mile (IES Handbook) range. An iridium coated precision reflector provides for maximum light output and sharp focus. The remote control panel controls lamp ignition (start-up) and focus from the pilot house. Superior cooling is provided by a heavy duty cooling fan which blows air across the lamp inside the sealed housing.

Both XR Series Searchlights include a single Xenon lamp. Perko offers a choice of several replacement lamps (1,000 and 1,600 watt) which will operate for the 9854 series searchlight when the proper amperage settings have been chosen. For the 9304 series, a 500 watt Xenon lamp is the only available option.

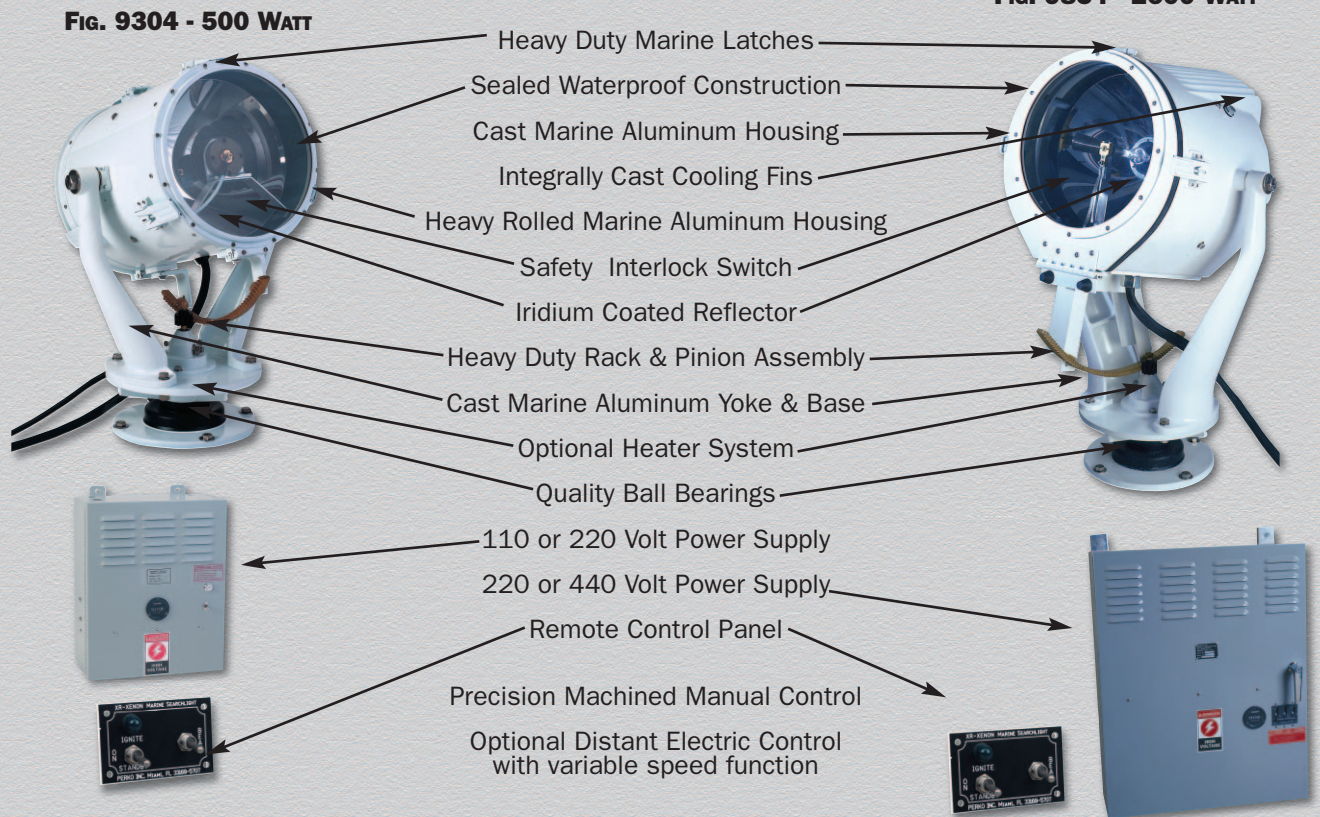

LEVER GEAR

Aim handle for horizontal position. Twist handle for vertical position.

REMOTE ELECTRIC

Joystick type controller with variable speed function for both horizontal & vertical positioning

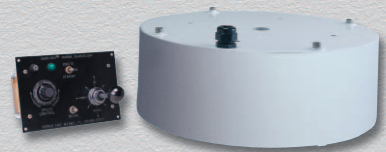

Figs. 9304 & 9854 CONTROL TYPES

XR SERIES 15" XENON SEARCHLIGHT

FIG. 9304 (500 WATT) WITH 120 OR 220 VAC POWER SUPPLY

Remote Distant Electric Control Base



TECH INFO		
Nominal Drum Diameter Inches	Nominal Searchlight Assembly Weight Pounds	IP Rating
13-3/4	71	65
Gross Shipping Weight Including Crate		Pounds
Searchlight		185
Power Supply		95
Control Rod & Tube		11.5
Base Diameter, 12 Inches.		

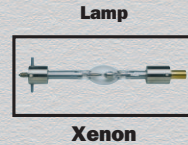

Lever/Gear Control

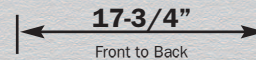

9551001 Remote Control Panel

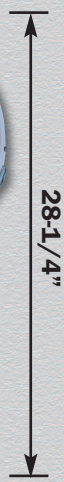

Head, Yoke and Base Assembly



9510010 Control Panel



Fig. 9511

500 Watt Power Supply



Complete 9304 XR Series Searchlights

ORDERING INFO With Distant Electric Control Base			
Lamp Type & Lamp Size	Voltage	Catalog No. Without Heaters	Catalog No. With Heaters
500 Watt Xenon	120 VAC	9304E01WH5	9304EH1WH5
500 Watt Xenon	220 VAC	9304E02WH5*	9304EH2WH5*

ORDERING INFO With Lever/Gear Controls			
Lamp Type & Lamp Size	Voltage	Catalog No. Without Heaters	Catalog No. With Heaters
500 Watt Xenon	120 VAC	9304L01WH5	9304LH1WH5
500 Watt Xenon	220 VAC	9304L02WH5*	9304LH2WH5*

NOTE: Lamps are included with complete Searchlights.

* 500 Watt 220 Power Supply Ships 60hz unless 50hz is requested.

XR SERIES 19" XENON SEARCHLIGHT

FIG. 9854 (1600 WATT) WITH 220 & 440 (3Ø) VAC POWER SUPPLY



Xenon

19-1/2"
Front to Back



Lever/Gear Control

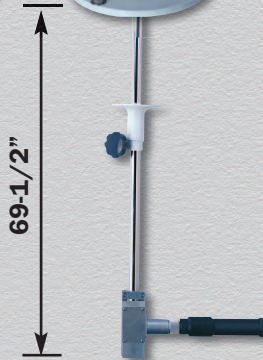

Head, Yoke and Base Assembly

69-1/2"

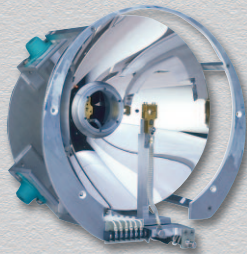

Fig. 9521000 Optical Assy.



38"

Complete 9854 XR Series Searchlights

TECH INFO

Nominal Drum Diameter Inches	Nominal Searchlight Assembly Weight Pounds	IP Rating
19	145	65
Gross Shipping Weight Including Crate		Pounds
Searchlight		310
Power Supply		250
Control Rod & Tube		11.5
Base Diameter, 12 Inches.		

Remote Distant Electric Control Base



3

9551001 Remote Control Panel



6"

18"

Figs. 9510/9512/9514 Power Supply



9510010 Control Panel

Ordering Info With Distant Electric Control Base

Lamp Type & Lamp Size	Voltage	Catalog No. Without Heaters	Catalog No. With Heaters
1000 Watt Xenon	220 VAC	9854E02WH0	9854EH2WH0
1600 Watt Xenon	220 VAC	9854E02WH6	9854EH2WH6
1000 Watt Xenon	440 VAC	9854E04WH0	9854EH4WH0
1600 Watt Xenon	440 VAC	9854E04WH6	9854EH4WH6

Ordering Info With Manual Lever Control

Lamp Type & Lamp Size	Voltage	Catalog No. Without Heaters	Catalog No. With Heaters
1000 Watt Xenon	220 VAC	9854L02WH0	9854LH2WH0
1600 Watt Xenon	220 VAC	9854L02WH6	9854LH2WH6
1000 Watt Xenon	440 VAC	9854L04WH0	9854LH4WH0
1600 Watt Xenon	440 VAC	9854L04WH6	9854LH4WH6

Lamps are included with complete searchlights.

PERKO® XR SERIES XENON SEARCHLIGHTS BULBS & SPARE COMPONENTS

Major Component Ordering Information

Components used in the XR Series searchlights are available as spare parts. Detailed ordering information can be found in the operator's maintenance manual for each light. In addition, power supplies can be easily exchanged for factory-rebuilt models offering a low cost means of upgrading or repairing an older unit in the field.

A unique design feature of the 1600-watt light is the ease with which the optical assembly can be changed by removing a few bolts and easily accessible wires. With this feature, complete optical assemblies (both new and factory refurbished) are available to easily upgrade or refurbish an old unit in the field.

Replacement control components, manuals and tools to make adjustments and lamp changing easier are shown below.

Searchlight Head and Optical Components

Cat. No.	Description
9504000	Complete 15" Searchlight Head with Optical Assembly
9508000	15" Searchlight Yoke & Base Assy Only
9501000	Complete 19" Searchlight Head with Optical Assembly
9506000	19" Searchlight Yoke & Base Assy Only
9521000	Removable 1,600 Watt Optical Assembly

Power Supply Components

Cat. No.	Description
9511000110	500 Watt-110 Volt Power Supply
9511000220	500 Watt-220 Volt Power Supply
9510000220	1,000 Watt-220 Volt (3Ø) Power Supply
9510000440	1,000 Watt-440 Volt (3Ø) Power Supply
9512000	1,600 Watt-220 Volt (3Ø) Power Supply
9514000	1,600 Watt-440 Volt (3Ø) Power Supply

Meters, Gauges & Control Components

Cat. No.	Description
9530000	Std. Length Lever Gear Mechanical Controls for Fig. 9854
9551000	Remote Distant Electric Controls for Fig. 9854
9510009	Remote Ammeter
9510003	Hour Meter
9510010	Control Panel Assembly
9551001	Control Panel for Distant Electric Base and Slave Controller

Additional Components

Cat. No.	Description
9510001	Accessory Transformer
9510013	Main Power Transformer
9521009	Excitation Transformer
9521017	Injection Transformer
9510011	Power Supply Fan
9521008	Optical Assembly Fan
9521003	Spark Gap Assembly
9510005	Ignite Toggle Switch
9510006	Beam Focus Switch

Searchlight Tools

Cat. No.	Description
9582001	9/64" Hex Lamp Changing Tool (1600 & 1000 Watt)
9582002	500 Watt Lamp Extractor Tool
9582003	1/4" x 10" Reflector Adjusting Wrench
9582005	Spare Emulator Kit for Fig. 9854 (See Manual Fig. 9581001 for item list)

Manuals

Cat. No.	Description
9581001	Installation Manual - For Fig. 9854 Complete Searchlights
9581002	Installation Manual - For Fig. 9551 Remote Distant Electric Control Unit
9581003	Installation Manual - For Figs. 9501 & 9521 Head and Optical Assemblies
9581004	Installation Manual - For Fig. 9304 Complete Searchlights

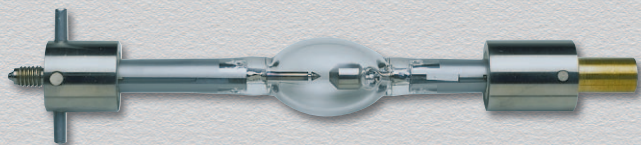

XR Series Xenon Lamps Ordering Info AMPERAGE RATINGS

WARNING!!
Xenon lamps are filled with Xenon Gas under high pressure. They may explode in either hot or cold state, especially if dropped or mishandled. **ALWAYS wear protective safety equipment** (a protective face mask with neck guard, chest protector, heavy clothing and leather gloves) **when handling a lamp.**

Xenon Lamp Size	Catalog Number	Current Range	Recommended Operation	Candle Power	Range Miles
300 Watt*	9563000	12A - 16A	15A @ 20V	20,000,000	3.1
500 Watt*	9565000	20A - 30A	30A @ 15V	35,000,000	3.8
1000 Watt	9560000	30A - 55A	50A @ 20V	80,000,000	5.1
1600 Watt	9566000	50A - 70A	65A @ 24V	100,000,000	5.5

* 300W and 500W lamps shown as replacements on earlier VARO 300W and 500W model searchlights only. Not used on 9854 series searchlights.

LAMP WARRANTIES REQUIRE COMPLETION OF WARRANTY REGISTRATION FORMS SHORTLY AFTER PURCHASE AND INSTALLATION

NOTE: PERKO offers a limited warranty on both the shelf and operating life of the XR series Xenon lamps. Please see the XR series "Limited Eighteen (18) Month Warranty" for all explicit terms and conditions of this warranty. All XR series Xenon lamps are supplied with an adapter sized to fit XR series searchlights. Adapters for other searchlights can be manufactured upon request. Contact customer service for details.

PERKO
Purchase Notification

Purchase Price _____

Date Completed _____

Date of Purchase _____

Authorized Dealer _____

Motor Vessel Name _____

PERKO Inc.
Miami, FL. 33169

PERKO
Warranty Registration

Warranty No. _____

Hour Meter Reading _____

Date of Installation _____

Authorized Dealer _____

Motor Vessel Name _____

PERKO Inc.
Miami, FL. 33169

1900 Series

All Aluminum - White Perko•Kote Finish 32, 120 or 230 Volts



3

The 1900 Series - Solar-Ray® Searchlights are designed and built with the commercial user in mind where maximum size and brilliance count. These units are constructed of marine aluminum with heavy duty castings and heavy gauge reinforced bodies for extra durability. They are finished in our white PERKO•KOTE finish, an advanced process that eliminates the need for painting while providing a scratch resistant and chip-proof surface for painting when necessary to match the color of the vessel.

The 1900 Series is available with Deck, Wheel, Lever/Gear or Distant Electric Remote Controls. All models feature halo deflectors, parabolic glass mirror reflectors for maximum light output and ventilation covers for quick dissipation of heat to help prolong bulb life. Hinged front doors have quick release stainless steel latches to provide easy access for bulb replacement.

Bulbs are not included and must be ordered separately. PERKO offers a choice of the traditional incandescent or the brighter, more piercing quartz-halogen bulbs in a variety of voltages and wattages. For complete information on bulbs and candlepower output, see page 96.

“1900 Series” High Power Searchlight Features

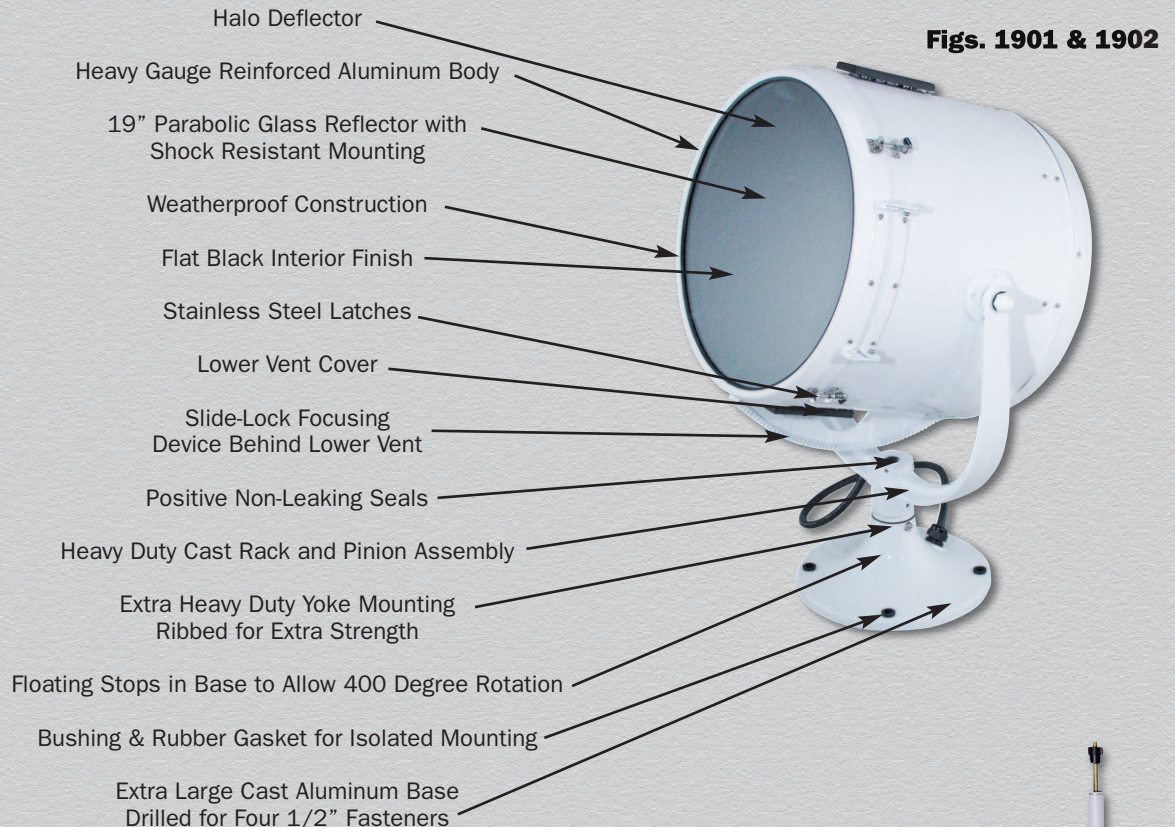

Fig. 1922

DECK CONTROL

Equipped with handles on the rear cover for positioning.

WHEEL CONTROL

Turn upper wheel for horizontal position. Turn lower wheel for vertical position.

CONTROL TYPES

DISTANT ELECTRIC CONTROL

Joystick type controller with variable speed control for both horizontal and vertical positioning



Fig. 1925

LEVER/GEAR CONTROL

Aim handle for horizontal position. Twist handle for vertical position.



Fig. 1921

19 INCH SOLAR-RAY® SEARCHLIGHT & CONTROL ASSEMBLIES



Lamp



INCANDESCENT

3

TECH INFO	
Nominal Drum Diameter Inches	Base Diameter
19	13

Fig. 1902 Light Shown With Fig. 1921 Lever/Gear Control

20-3/4"



Fig. 1902DE4 Light Shown With Fig. 1925 Distant Electric Control

6"



22"



Fig. 1901 Deck Control

WATER-PROOF SEAL FOR GEAR MECHANISM



Fig. 1902 Light Shown With Fig. 1922 Wheel Control

Distance Between Wheels, 2-1/2 Inches.



32-3/4"

All Aluminum - White Perko•Kote Finish

ORDERING INFO

Description	Catalog No.	Weights
Deck Control Searchlight Head Assembly*	1901004WHT	76 lbs.
Wheel or Lever/Gear Control Searchlight Head Assembly (Requires Control Assembly Below)	1902004WHT	76 lbs.
Searchlight Head Assembly For Distant Electric Control Base	1902DE4WHT	103 lbs.
Wheel Control Assembly (For Above)	1922000WHT	10.3 lbs.
Lever/Gear Control Assembly (For Above)	1921000WHT	100 lbs.
Distant Electric Control Assembly (For Above)	1925000WHT	50 lbs.

*Cannot Be Fitted With Alternate Controls.

Custom Control Lengths and Pedestal Heights Are Available. Price Upon Application. Specify Measurements.

Bulbs Are Not Included in Lights (See Page 96).

SPARE PARTS FOR 1900 SERIES SOLAR-RAY® SEARCHLIGHTS

Electric Socket and Support Stand Assemblies for 19 Inch Searchlights

Solar-Ray® Searchlights include a socket and support stand based on the bulb or socket information given when ordering. The following chart makes it possible to order and stock different assemblies for field conversion, to meet a large variety of voltage and candlepower requirements with a minimum of inventory.

ORDERING INFO			
Socket Type	Socket Code	Socket & Stand Catalog Number	Height Stand Inches
Medium Screw	B	0872004	5-3/4
Medium Prefocus	E	0873004	5-7/16
Mogul Prefocus (1500 Watt)	L	1930004	3-5/8
Mogul Prefocus (1000 & 2000 Watt)	M	1931004	3-1/8
2-Pin Prefocus (900 Watt)	K	0880004	7-5/16

Replacement Socket Ordering Info For 0800 Series and 1900 Series Solar-Ray® Searchlights

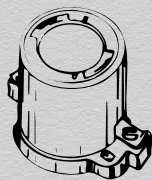

Mogul Prefocus Socket
(Codes "L & M")
Catalog No. 0893

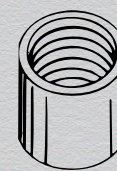

Medium Screw Socket
(Code "B")
Catalog No. 0894



Medium Prefocus Socket
(Code "E")
Catalog No. 0895

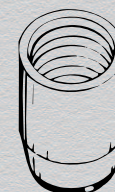

Mogul Screw Socket
(Code "D")
Catalog No. 0897

OLD SOCKET	NEW SOCKET
<p>2-Pin Prefocus Socket (Codes "F, G, H & I"*) Catalog No. 0899</p>	<p>2-Pin Prefocus Socket (Code "F, G, H, I & K"*) Catalog No. 0899</p>

OLD SOCKET	NEW SOCKET
<p>2-Pin Prefocus Socket (Code "K"**) Catalog No. 0866</p>	<p>2-Pin Prefocus Socket (Code "K"**) Catalog No. 0899</p>

*For Use In 10", 12" and 14" Searchlights Except When Catalog No. 0839, 900 Watt Bulb is Used.

**For Use In 12", 14" and 19" Searchlights Only When the Catalog No. 0839, 900 Watt Bulb is Used.

19 INCH SOLAR-RAY® SEARCHLIGHT BULB & SOCKET INFORMATION

Bulb Ordering Information For 19 Inch Searchlights

For best results, the bulb and reflector must be perfectly compatible; therefore be sure to specify the catalog number of the bulb desired. Peak candlepower is exceedingly sensitive to many factors, (i.e., a light source out of focus by 1/32 inch, under-voltage of only 4%, or differences between bulb manufacturers) which can cause a reduction of range of up to 20%. See below. For a more concentrated beam, longer range, brighter light and a longer life, we recommend the Quartz/Halogen bulbs.

Voltage	Approx. Range Miles*	Bulb Catalog Number	Bulb Type	Socket Type	Socket Code Letter	Wattage	Rated Life Hours**	Maximum Candlepower Output	Horizontal Beam Spread Degrees	Vertical Beam Spread Degrees	Mfg. Bulb Code
32	1-2/3	0806	Incandescent	Medium Screw	B	500	50	3,520,000	3.5	3.7	DLT
120	1-5/8	0807	Incandescent	Medium Prefocus	E	500	25	3,191,000	3.5	4.0	CZX
120	1-3/8	0837	Incandescent	Medium Prefocus	E	750	200	2,076,000	3.6	4.2	DDY
120	1-3/4	0809	Incandescent	Medium Prefocus	E	750	25	4,569,000	3.6	4.5	DDB
120	2	0810	Incandescent	Medium Prefocus	E	1000	25	5,622,000	3.6	4.2	DRS
120	1-3/4	0844	Quartz/Halogen	Medium Prefocus	E	500	500	3,861,000	3.0	5.4	BTL
120	1-5/8	0845	Quartz/Halogen	Medium Prefocus	E	750	200	2,871,000	3.6	5.4	BTP
120	2	0839	Quartz/Halogen	2-Pin Prefocus	K	900	75	5,769,000	5.9	5.4	BVA
120	1-2/3	0847	Quartz/Halogen	Mogul Prefocus	M	1000	200	3,659,000	4.5	5.4	BVV
120	1-7/8	0846	Quartz/Halogen	Medium Prefocus	E	1000	200	4,601,000	4.5	5.4	BTR
120	2	0848	Quartz/Halogen	Mogul Prefocus	L	1500	300	5,596,000	5.9	5.7	DTA
120	1-2/3	0859	Quartz/Halogen	Mogul Prefocus	M	2000	250	3,633,000	9.4	5.9	BVW
230	1-3/8	0860	Quartz/Halogen	Medium Prefocus	E	1000	950	2,162,000	7.9	6.5	FKD

*The approximate ranges listed above are based on photometric measurements of beam candlepower output under ideal conditions. Many factors such as atmospheric conditions, size and color of target, background, etc., may reduce effective range considerably; therefore, these figures are offered only as a guide to compare different bulb and voltage options.

Please Order Carefully, Bulbs Are Not Returnable.

**NOTE: These are the "Rated Average Laboratory Life in Hours" of the Bulb Manufacturer obtained in closely controlled laboratory life testing of groups of lamps at their design voltage. It is not necessarily the same as the service life where conditions such as shock, vibration, voltage fluctuation and environment may result in a shorter average attained life.

Spare Parts Ordering Information For 19 Inch Searchlights

ORDERING INFO					
Fig. No.	Front Glass	Front Door with Glass	Rear Cover	Reflector*	Pinion Gear
1901	0889004CLR	1936000WHT	1932000WHT	0890004	—
1902	0889004CLR	1936000WHT	1933000WHT	0890004	0905

*Replacement Retaining Clips (Cat. No. 0911) for the Reflector Should Also Be Ordered When Ordering a Replacement Reflector to Assure a Proper Fit.

0800 Series**10", 12" or 14"****Cast Bronze and Heavy Gauge Brass
Polished Chrome or White Perko•Kote Finish
12, 24, 32, 120 or 230 Volts****3**

The 0800 Series - Solar-Ray® Searchlights are available in 10", 12" and 14" sizes with your choice of Deck, Wheel, Lever/Gear Controls or DEC on 14 inch model. All models feature: halo deflectors, parabolic glass mirror reflectors for maximum light output and ventilation covers for quick dissipation of heat to help prolong bulb life. Hinged front doors have quick release stainless steel latches to provide easy access for bulb replacement. The 0800 Series models are also available in our white PERKO•KOTE finish, an advanced powder coating process that eliminates the need for painting while providing a scratch resistant and chip-proof surface for painting when necessary to match the color of the vessel.

Bulbs are not included and must be ordered separately. PERKO offers a choice of the traditional incandescent or the brighter, more piercing quartz-halogen bulbs in a variety of voltages and wattages to fit every need. For complete information on bulbs and candlepower output, see pages 106 & 107.

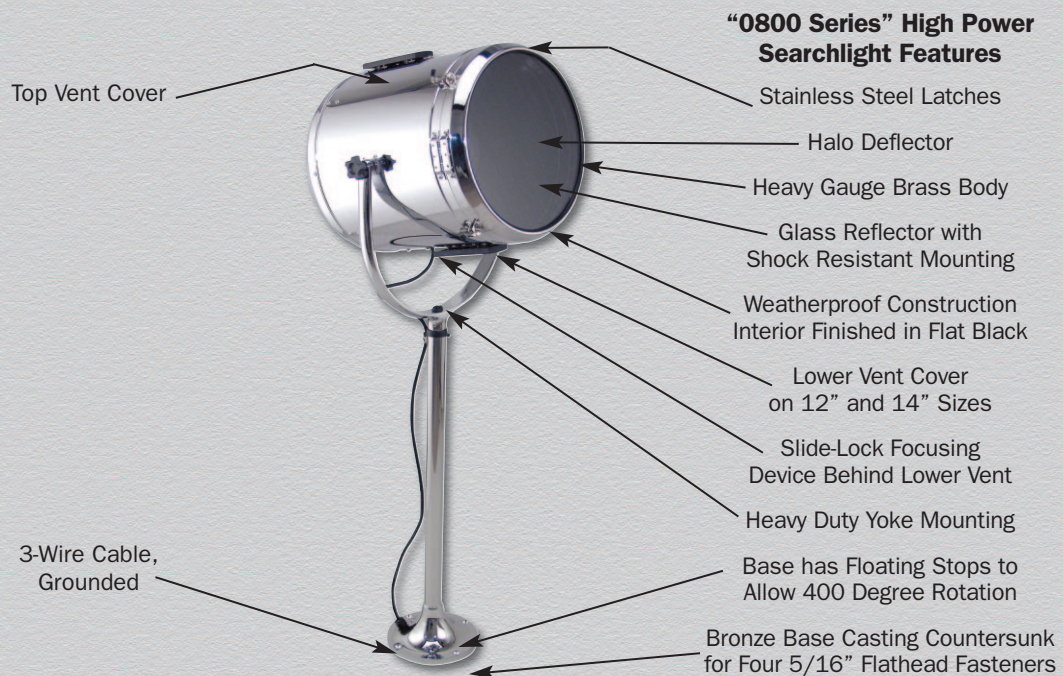
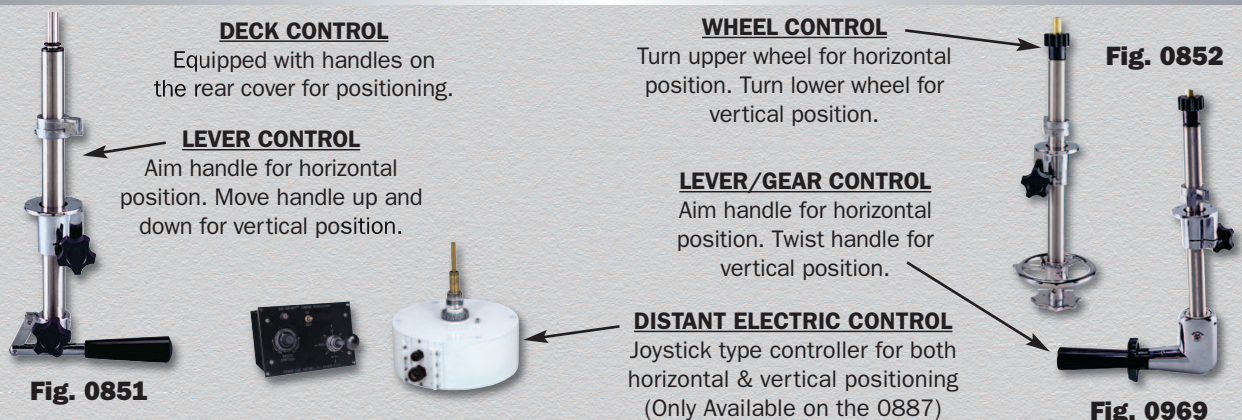
**BULBS ARE NOT INCLUDED IN LIGHTS.****CONTROL TYPES**

0883 Series Deck Control Solar-Ray® Searchlights

10", 12" or 14"



3

TECH INFO		
"A" Nominal Drum Diameter Inches	"C" Length Drum Inches	Approx. Ship Weight Pounds
10	13	28
12	15	38
14	17	45

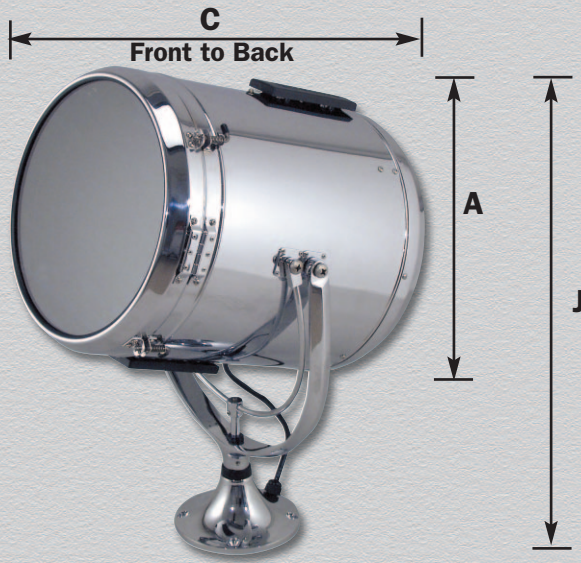

Fig. 0883 - Standard Pedestal Chrome



Fig. 0883 - High Pedestal Chrome



Fig. 0883 - Medium Pedestal White

- A - Nominal drum diameter
- C - Drum length
- J - Overall height from mounting surface to top of searchlight

Bulbs Are Not Included in Lights (See Pages 106 & 107).

0883 Series Deck Control Solar-Ray® Searchlights

10", 12" or 14"

Ordering Info

- NOTES:
- 1) These Searchlights Cannot Be Fitted With Controls.
 - 2) Bulbs Must be Ordered Separately, Refer to Pages 106 and 107 for Ordering Information.
 - 3) Refer to Worksheet on Page 105 For Help in Bulb Ordering.

3

ORDERING INFO - STANDARD PEDESTAL

Nominal Reflector Size Inches	"J" Height Overall Inches	Polished Chrome Catalog No.	White PERKO•KOTE Catalog No.
10	20-1/8	08830P1CHR	08830P1WHT
12	22-1/8	08830P2CHR	08830P2WHT
14	25-1/8	08830P3CHR	08830P3WHT

Standard Pedestal Base Diameter, 7 Inches

ORDERING INFO - MEDIUM PEDESTAL

Nominal Reflector Size Inches	"J" Height Overall Inches	Polished Chrome Catalog No.	White PERKO•KOTE Catalog No.
10	27-1/2	0883MP1CHR	0883MP1WHT
12	29-1/2	0883MP2CHR	0883MP2WHT
14	32-1/2	0883MP3CHR	0883MP3WHT

Medium Pedestal Base Diameter, 8 Inches

ORDERING INFO - HIGH PEDESTAL

Nominal Reflector Size Inches	"J" Height Overall Inches	Polished Chrome Catalog No.	White PERKO•KOTE Catalog No.
10	44	0883HP1CHR	0883HP1WHT
12	46	0883HP2CHR	0883HP2WHT
14	49	0883HP3CHR	0883HP3WHT

High Pedestal Base Diameter, 8 Inches

**NOTE: Custom Pedestal Heights are Available.
Price Upon Application.
Specify the "J" Dimension for Custom Pedestal Height.**

**High Pedestal
White**



**Med. Pedestal
White**



**Std. Pedestal
White**



**Std. Pedestal
Chrome**



**Med. Pedestal
Chrome**



**High Pedestal
Chrome**



0884 Series Lever Control Solar-Ray® Searchlights 10", 12" and 14"



3

TECH INFO		
"A" Nominal Drum Diameter Inches	"C" Length Drum Inches	Approx. Ship Weight Pounds
10	13	28
12	15	38
14	17	45



**Fig. 0884
Standard Pedestal
Chrome**

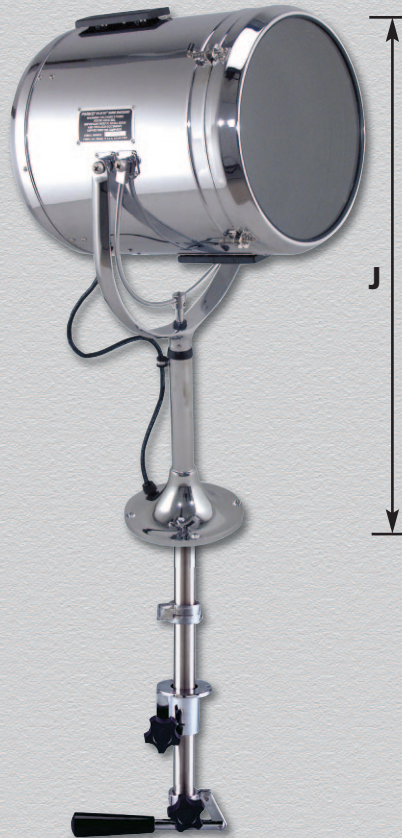

**Fig. 0884
Medium Pedestal
Chrome**

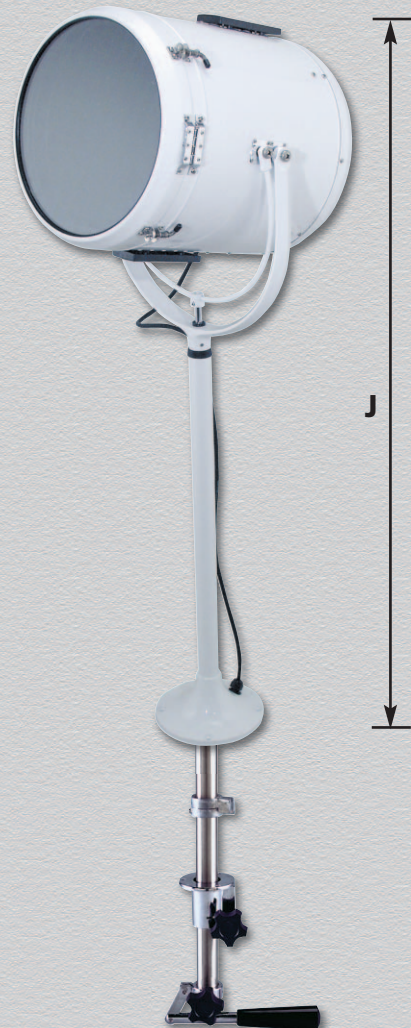

**Fig. 0884
High Pedestal
White**

- A - Nominal drum diameter
- C - Drum length
- J - Overall height from mounting surface to top of searchlight
- E - Control length

Bulbs Are Not Included in Lights (See Pages 106 & 107).

LEVER CONTROL SOLAR-RAY® SEARCHLIGHT HEAD ASSEMBLIES

0884 Series Lever Control Solar-Ray® Searchlights 10", 12" and 14" Ordering Info

- Notes: 1) Bulbs Must be Ordered Separately, Refer to Pages 106 and 107 for Ordering Information.
2) Refer to Worksheet on Page 105 For Help in Bulb Ordering.

3

ORDERING INFO - STANDARD PEDESTAL HEAD ASSEMBLIES

Nominal Reflector Size Inches	"J" Height Inches	Polished Chrome Catalog No.	White PERKO•KOTE Catalog No.
10	20-1/8	08840P1CHR	08840P1WHT
12	22-1/8	08840P2CHR	08840P2WHT
14	25-1/8	08840P3CHR	08840P3WHT

Standard Pedestal Base Diameter, 7 Inches

ORDERING INFO - MEDIUM PEDESTAL HEAD ASSEMBLIES

Nominal Reflector Size Inches	"J" Height Inches	Polished Chrome Catalog No.	White PERKO•KOTE Catalog No.
10	28-1/4	0884MP1CHR	0884MP1WHT
12	30-1/4	0884MP2CHR	0884MP2WHT
14	33-1/4	0884MP3CHR	0884MP3WHT

Medium Pedestal Base Diameter, 8 Inches

ORDERING INFO - HIGH PEDESTAL HEAD ASSEMBLIES

Nominal Reflector Size Inches	"J" Height Inches	Polished Chrome Catalog No.	White PERKO•KOTE Catalog No.
10	44-3/4	0884HP1CHR	0884HP1WHT
12	46-3/4	0884HP2CHR	0884HP2WHT
14	49-3/4	0884HP3CHR	0884HP3WHT

High Pedestal Base Diameter, 8 Inches



NOTE: Custom Pedestal Heights are Available. Price Upon Application. Specify the "J" Dimension for Custom Pedestal Height.

Fig. 0851 - Lever Control Assemblies

Control assemblies of different lengths may be interchanged on Solar-Ray® searchlights (Fig. 0884) of the same pedestal height. The following chart makes it possible to order and stock different lengths of these assemblies separately to offer a large variety of Solar-Ray® searchlights with a minimum of inventory. Custom Control Lengths are Available. Price Upon Application. Specify the "E" Dimension for Custom Control Lengths.

ORDERING INFO

"E" Length Control Inches	O For Standard Pedestal	M For Medium Pedestal	H For High Pedestal Cat. No.	Approx. Ship Weight Lbs. O/M/H
8-1/2	0851000*	0851M00*	0851H00*	3.4/4.3/6.1
15-1/2	08510A0	0851MA0	0851HA0	4.1/4.9/6.3
22-1/2	08510B0	0851MB0	0851HB0	5.0/5.8/6.9
29-1/2	08510C0	0851MC0	0851HC0	5.8/6.6/8.5

* Maximum Ceiling Thickness, 4-1/2 Inches

WHEEL OR LEVER/GEAR CONTROL SOLAR-RAY® SEARCHLIGHTS

0885 Series Wheel or Lever/Gear Control Solar-Ray® Searchlights 10", 12" and 14"



3

TECH INFO		
"A" Nominal Drum Diameter <u>Inches</u>	"C" Length Drum <u>Inches</u>	Nominal Weight <u>Pounds</u>
10	13	28
12	15	38
14	17	45

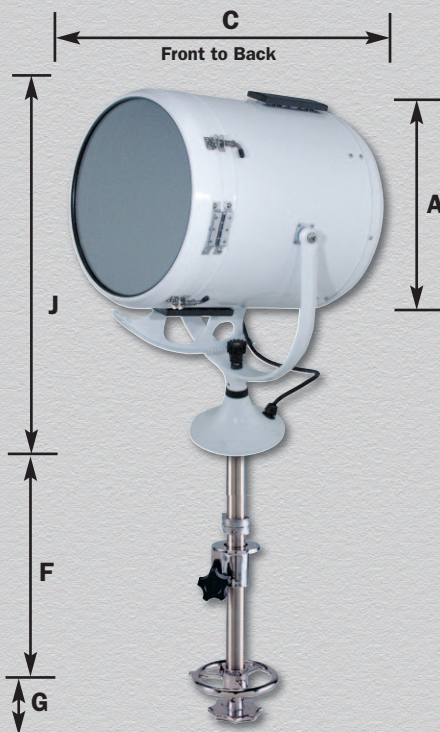

**Fig. 0885 White
Standard Pedestal
Shown With Wheel Control**



**Fig. 0885 Chrome
Medium Pedestal
Shown With
Lever/Gear Control**



**Fig. 0885 Chrome
High Pedestal
Shown With Wheel Control**

- A - Nominal drum diameter
- C - Drum length
- E - Control length (lever/gear control)
- F - Control length (wheel control)
- G - Distance between wheels, 2 inches.
- J - Overall height from mounting surface to top of searchlight

Bulbs Are Not Included in Lights (See Pages 106 & 107).

WHEEL OR LEVER/GEAR CONTROL SOLAR-RAY® SEARCHLIGHT HEAD ASSEMBLIES

0885 Series Wheel or Lever/Gear Control Solar-Ray® Searchlights 10", 12" and 14" Ordering Info

Notes: 1) Bulbs Must be Ordered Separately, Refer to Pages 106 and 107 for Ordering Information.
2) Refer to Worksheet on Page 105 For Help in Bulb Ordering.

ORDERING INFO - STANDARD PEDESTAL HEAD ASSEMBLIES

Nominal Reflector Size Inches	"J" Height Inches	Polished Chrome Catalog No.	White PERKO•KOTE Catalog No.
10	20-1/8	08850P1CHR	08850P1WHT
12	22-1/8	08850P2CHR	08850P2WHT
14	25-1/8	08850P3CHR	08850P3WHT

Standard Pedestal Base Diameter, 7 Inches

ORDERING INFO - MEDIUM PEDESTAL HEAD ASSEMBLIES

Nominal Reflector Size Inches	"J" Height Inches	Polished Chrome Catalog No.	White PERKO•KOTE Catalog No.
10	28-1/4	0885MP1CHR	0885MP1WHT
12	30-1/4	0885MP2CHR	0885MP2WHT
14	33-1/4	0885MP3CHR	0885MP3WHT

Medium Pedestal Base Diameter, 8 Inches

ORDERING INFO - HIGH PEDESTAL HEAD ASSEMBLIES

Nominal Reflector Size Inches	"J" Height Inches	Polished Chrome Catalog No.	White PERKO•KOTE Catalog No.
10	44-3/4	0885HP1CHR	0885HP1WHT
12	46-3/4	0885HP2CHR	0885HP2WHT
14	49-3/4	0885HP3CHR	0885HP3WHT

High Pedestal Base Diameter, 8 Inches

High Pedestal White



Med. Pedestal White



Std. Pedestal White



Std. Pedestal Chrome



Med. Pedestal Chrome



High Pedestal Chrome



NOTE: Custom Pedestal Heights are Available. Price Upon Application. Specify the "J" Dimension for Custom Pedestal Height.

Control Assemblies - Figs. 0852 & 0969

Control assemblies of different lengths may be interchanged on Solar-Ray® searchlights (Fig. 0885) of the same pedestal height. The following chart makes it possible to order and stock different lengths of these assemblies separately to offer a large variety of Solar-Ray® Searchlights with a minimum of inventory.

ORDERING INFO WHEEL CONTROL - FIG. 0852

"F" Length Control Inches	0 For Standard Pedestal	M For Medium Pedestal	H For High Pedestal	Nominal Wt. Lbs. 0/M/H
7-1/2	0852000*	0852M00*	0852H00*	4.1/5.0/7.0
14-1/2	08520A0	0852MA0	0852HA0	4.9/5.7/7.6
21-1/2	08520B0	0852MB0	0852HB0	5.8/6.5/8.5
28-1/2	08520C0	0852MC0	0852HC0	6.5/7.3/9.2

*Maximum Ceiling Thickness, 3 Inches

ORDERING INFO LEVER/GEAR CONTROL - FIG. 0969

"E" Length Control Inches	0 For Standard Pedestal	M For Medium Pedestal	H For High Pedestal	Nominal Wt. Lbs. 0/M/H
8-1/2	0969000*	0969M00*	0969H00*	5.2/6.1/7.8
15-1/2	09690A0	0969MA0	0969HA0	6.0/6.6/8.5
22-1/2	09690B0	0969MB0	0969HB0	6.9/7.6/9.4
29-1/2	09690C0	0969MC0	0969HC0	7.6/8.3/10.2

*Maximum Ceiling Thickness, 3-1/2 Inches

NOTE: Custom Control Lengths are Available. Price Upon Application. Specify the "E" or "F" Dimension for Custom Control Lengths.



3

0887 Series for 12, 24 & 120 Volt

TECH INFO

Nominal Drum Diameter <u>Inches</u>	Length Drum <u>Inches</u>	Gross Shipping Weight <u>Pounds</u>
14	17	68

Lamp



Incandescent

Distant Electric Control

Joystick type controller
with variable speed control
for both horizontal &
vertical positioning



Fig. 0887 - Standard Pedestal
With DEC Base

All Aluminum - White Perko•Kote Finish

ORDERING INFO

Description	Catalog No.
Searchlight Head Assembly w/ Distant Electric Control Base - 12 Volt	0887EA3WHT
Searchlight Head Assembly w/ Distant Electric Control Base - 24 Volt	0887EB3WHT
Searchlight Head Assembly w/ Distant Electric Control Base - 120 Volt	0887EC3WHT

Bulbs Are Not Included in Lights (See Pages 106 & 107).

SOLAR-RAY® SEARCHLIGHT ORDERING WORKSHEET

0800 Series



- 1) **Head Assembly Type:** _____ }
 - a) For deck control - 0883
 - b) For lever control - 0884
 - c) For wheel and lever/gear control - 0885
- 2) **Pedestal (overall) Height (see catalog page for details):** _____ }
 - a) Standard - 0
 - b) Medium - M
 - c) High - H

For custom pedestal height see no. 10 below.
- 3) **Reflector Size:** _____ }
 - a) 10 inch - 1
 - b) 12 inch - 2
 - c) 14 inch - 3
- 4) **Finish:** _____ }
 - a) PERKOPLATE (polished chrome) - CHR
 - b) PERKO•KOTE (white) - WHT
- 5) **Control Type:** _____ }
 - a) Lever control (For 0884 Head Assembly) - 0851
 - b) Wheel control (For 0885 Head Assembly) - 0852
 - c) Lever/Gear control (For 0885 Head Assembly) - 0969
- 6) **Control Length (when necessary):** _____ }
 - a) (8-1/2" for 0851 & 0969) or (7-1/2" for 0852) - 0
 - b) (15-1/2" for 0851 & 0969) or (14-1/2" for 0852) - A
 - c) (22-1/2" for 0851 & 0969) or (21-1/2" for 0852) - B
 - d) (29-1/2" for 0851 & 0969) or (28-1/2" for 0852) - C
- 7) **Bulb Number (see pages 106 & 107 for details):** _____ }
 - a) Medium Screw "B"
 - b) Medium Prefocus..... "E"
 - c) Mogul Screw..... "D" (Not for use with 10 inch reflector.)
 - d) 2-Pin Prefocus (12 volt) "F"
 - e) 2-Pin Prefocus (24 volt) "G"
 - f) 2-Pin Prefocus (32 volt) "H"
 - g) 2-Pin Prefocus (600 Watt) "I"
 - h) 2-Pin Prefocus (900 watt) "K"
- 8) **Socket Type:** _____ Code: _____ }
 - a) Medium Screw "B"
 - b) Medium Prefocus..... "E"
 - c) Mogul Screw..... "D" (Not for use with 10 inch reflector.)
 - d) 2-Pin Prefocus (12 volt) "F"
 - e) 2-Pin Prefocus (24 volt) "G"
 - f) 2-Pin Prefocus (32 volt) "H"
 - g) 2-Pin Prefocus (600 Watt) "I"
 - h) 2-Pin Prefocus (900 watt) "K"
- 9) **Custom control length:** _____ }

Specify control length desired as measured from pedestal base to lower end of control assembly ("E" or "F" dimension).
- 10) **Custom pedestal height:** _____ }

Specify overall height of searchlight desired as measured from the top of the searchlight head to the bottom of the pedestal base ("J" dimension).

Head Assembly Cat. No. [] [P] [] []

Control Assembly Cat. No. [] [] [] [0]

Bulb Cat. No. []

Socket Code []

Spare Parts Ordering Info for 0800 Series Solar-Ray® Searchlights						
Fig.	Size	Front Glass Cat. No.	Front Door with Glass Cat. No. *	Rear Cover Cat. No. *	Reflector** Cat. No.	Pinion Gear Cat. No.
0883	10"	0889001CLR	0891001CHR	0908001CHR	0890001	—
	12"	0889002CLR	0891002CHR	0908002CHR	0890002	—
	14"	0889003CLR	0891003CHR	0908003CHR	0890003	—
0884	10"	0889001CLR	0891001CHR	0902001CHR	0890001	—
	12"	0889002CLR	0891002CHR	0902002CHR	0890002	—
	14"	0889003CLR	0891003CHR	0902003CHR	0890003	—
0885	10"	0889001CLR	0891001CHR	0902001CHR	0890001	0905
	12"	0889002CLR	0891002CHR	0902002CHR	0890002	0905
	14"	0889003CLR	0891003CHR	0902003CHR	0890003	0905

* NOTE: The Spare Part catalog numbers listed above are for the polished chrome (CHR) finish. To order white finish, replace the "CHR" in the catalog number with the "WHT" finish code.

**Replacement Retaining Clips (Cat. No. 0910) For The Reflector Should Also Be Ordered When Ordering a Replacement Reflector To Assure a Proper Fit.

BULB TECHNICAL DATA FOR SOLAR-RAY® SEARCHLIGHTS

0800 Series Bulbs

The Following Chart is Provided to Aid in Proper Bulb Selection:

Searchlight Size Inches	Voltage	Approximate Range Miles*	Bulb Catalog Number	Bulb Wattage	Rated Life Hours**	Maximum Candlepower Output	Horizontal Beam Spread Degrees	Vertical Beam Spread Degrees
10"	12	1	0816	100	50	1,168,000	1.7	1.4
	24	1	0836	150	50	891,000	2.6	1.5
	32	3/4	0817	200	200	571,000	2.6	1.7
	32	1	0806	500	50	943,000	3.4	3.9
	120	1	0820	600	75	908,000	4.4	2.2
	120	1-1/8	0807	500	25	1,332,000	3.5	2.8
	120	1-1/8	0844	500	500	1,260,000	3.1	3.4
12"	12	1-1/4	0816	100	50	1,617,000	1.5	1.2
	24	1-1/8	0836	150	50	1,349,000	2.2	1.5
	32	7/8	0817	200	200	865,000	2.4	1.6
	32	1-1/8	0806	500	50	1,496,000	3.4	3.5
	120	1	0837	750	200	977,000	4.1	3.7
	120	1	0845	750	200	1,185,000	3.7	5.2
	120	1-1/8	0820	600	75	1,410,000	4.3	1.9
	120	1-1/4	0809	750	25	1,792,000	3.6	3.4
	120	1-1/4	0844	500	500	1,641,000	3.2	3.4
	120	1-1/4	0807	500	25	1,799,000	3.3	3.1
	120	1-1/4	0811	1000	50	1,816,000	4.0	4.9
	120	1-3/8	0810	1000	25	1,894,000	4.0	3.8
	120	1-3/8	0846	1000	200	1,911,000	3.9	5.0
	120	1-1/2	0839	900	75	2,482,000	4.5	5.5
	230	7/8	0860	1000	950	865,000	6.9	5.9
14"	12	1-1/4	0816	100	50	1,756,000	1.5	1.0
	24	1-1/8	0836	150	50	1,367,000	2.3	1.2
	32	1	0817	200	200	943,000	2.2	1.5
	32	1-1/8	0806	500	50	1,591,000	4.0	3.7
	120	1-1/8	0837	750	200	1,254,000	3.9	4.5
	120	1-1/8	0845	750	200	1,531,000	3.6	5.1
	120	1-1/4	0820	600	75	1,626,000	4.5	1.9
	120	1-3/8	0844	500	500	1,840,000	2.9	3.2
	120	1-3/8	0811	1000	50	2,249,000	4.0	5.1
	120	1-1/2	0807	500	25	2,353,000	3.2	3.2
	120	1-1/2	0809	750	25	2,422,000	3.7	4.0
	120	1-1/2	0846	1000	200	2,586,000	3.8	5.0
	120	1-1/2	0810	1000	25	2,621,000	4.0	4.5
	120	1-5/8	0839	900	75	2,889,000	4.5	5.2
	230	1	0860	1000	950	1,021,000	7.7	6.2

*The approximate ranges listed above are based on photometric measurements of beam candlepower output under ideal conditions. Many factors such as atmospheric conditions, size and color of target, background, etc., may reduce effective range considerably; therefore, these figures are offered only as a guide to compare different bulb and voltage options.

**NOTE: These are the "Rated Average Laboratory Life in Hours" of the Bulb Manufacturer obtained in closely controlled laboratory life testing of groups of lamps at their design voltage. It is not necessarily the same as the service life where conditions such as shock, vibration, voltage fluctuation and environment may result in a shorter average attained life.



2-PIN PREFOCUS



MOGUL SCREW



MEDIUM PREFOCUS



MEDIUM SCREW

BULB AND SOCKET ORDERING INFORMATION FOR SOLAR-RAY® SEARCHLIGHTS

0800 Series Bulbs

Bulbs Are Not Included in Lights and Must Be Ordered Separately.

For best results, the bulb and reflector must be perfectly compatible; therefore, be sure to specify the catalog number of the bulb desired. Peak candlepower is exceedingly sensitive to many factors, (i.e., a light source out of focus by 1/32 inch, under-voltage of only 4%, or differences between bulb manufacturers) which can cause a variation in range of up to 20%.

3

INCANDESCENT BULB ORDERING INFO

Bulb Catalog Number	Voltage	Wattage	Socket Type	Socket Code Letter	For Searchlight Sizes Inches	Rated* Life Hours	Mfg. Bulb Code
0806	32	500	Medium Screw	B	10, 12, 14	50	DLT
0807	120	500	Medium Prefocus	E	10, 12, 14	25	CZX/DAB
0809	120	750	Medium Prefocus	E	12, 14	25	DDB
0837	120	750	Medium Prefocus	E	12, 14	200	DGH
0810	120	1000	Medium Prefocus	E	12, 14	25	DRS
0811	120	1000	Mogul Screw	D	12, 14	50	DPT

For a More Concentrated Beam, Longer Range, Brighter Light and a Longer Life, We Recommend the Following Bulbs:

“QUARTZ” TUNGSTEN-HALOGEN BULB ORDERING INFO

Bulb Catalog Number	Voltage	Wattage	Socket Type	Socket Code Letter	For Searchlight Sizes Inches	Rated* Life Hours	Mfg. Bulb Code
0816	12	100	2-Pin Prefocus	F	10, 12, 14	50	FDT
0836	24	150	2-Pin Prefocus	G	10, 12, 14	50	DZE-FDS
0817	32	200	2-Pin Prefocus	H	10, 12, 14	200	1945
0844	120	500	Medium Prefocus	E	10, 12, 14	500	BTL
0820	120	600	2-Pin Prefocus	I	10, 12, 14	75	DYS
0845	120	750	Medium Prefocus	E	12, 14	200	BTP
0839	120	900	2-Pin Prefocus	K	12, 14	75	BVA
0846	120	1000	Medium Prefocus	E	12, 14	200	BTR
0860	230	1000	Medium Prefocus	E	12, 14	950	FKD

Please Order Carefully, Bulbs are Not Returnable.

*NOTE: These are the “Rated Average Laboratory Life in Hours” of the Bulb Manufacturer obtained in closely controlled laboratory life testing groups of lamps at their design voltage. It is not necessarily the same as the service life where conditions such as shock, vibration, voltage fluctuation and environment may result in a shorter average attained life.

Electric Socket and Support Stand Assemblies

Solar-Ray® Searchlights include a socket and support stand assembly based on the bulb or socket information given when ordering. The following chart makes it possible to order and stock different socket and stand assemblies for field conversion to meet a large variety of voltage and candlepower requirements with a minimum of inventory.

ORDERING INFO

Socket Type (See Page 95 for Drawing)	Socket Code	For 10” Searchlights		For 12” Searchlights		For 14” Searchlights	
		Catalog Number	Height Stand Inches	Catalog Number	Height Stand Inches	Catalog Number	Height Stand Inches
Medium Screw	B	0872001	1-1/4	0872002	2-1/4	0872003	3-1/4
Medium Prefocus	E	0873001	1-5/16	0873002	1-15/16	0873003	2-15/16
Mogul Screw	D	—	—	0874002	7/16	0874003	1-1/4
2-Pin Prefocus (12 Volt)	F	0875001	3-1/2	0875002	4-1/2	0875003	5-1/2
2-Pin Prefocus (24 Volt)	G	0876001	3-1/4	0876002	4-1/4	0876003	5-1/4
2-Pin Prefocus (32 Volt)	H	0878001	3-1/4	0878002	4-1/4	0878003	5-1/4
2-Pin Prefocus (600 Watt)	I	0879001	3-1/8	0879002	4-1/8	0879003	5-1/8
2-Pin Prefocus (900 Watt)	K	—	—	0880002	3-13/16	0880003	4-13/16

NOTE: Refer to Page 95 for Spare/Replacement Electric Socket Only Ordering Information.

PERKO® PILOT HOUSE CONTROL SEALED BEAM SEARCHLIGHT



3



Fig. 0314 - Pilot House Control Searchlight

CONSTRUCTION:

- Chrome Plated or White PERKO•KOTE Powder Coated Brass
 - Corrosion Resistant, Splash Proof Construction
 - 7 & 8 Inch Sealed Beam Units Included
 - Tin Plated Electrical Contacts and Wiring
 - Lever Action, Pilot House Control
 - 380° Horizontal Movement, 70° Vertical Movement
 - Lever Handle Controls both Horizontal and Vertical Movement
 - For Ceiling Thicknesses of up to 5"
 - For 12, 24 or 32 Volts



**Fig. 0314
Chrome**



**Fig. 0314
White**

ORDERING & TECH INFO

Overall Length	Approx. Range Voltage	Beam Range Miles	Candle Power	Wattage	Chrome Catalog Number	White Catalog Number	Ship Wt. Carton Lbs. Std. Pkg.
7 Inch Head							
24	12	5/8	250,000	100	0314C0712V	0314W0712V	13.1
24	24	3/4	470,000	450	0314C0724V	0314W0724V	13.1
24	32	5/8	260,000	200	0314C0732V	0314W0732V	13.1
8 Inch Head							
26	12	3/4	500,000	250	0314C0812V	0314W0812V	13.4
26	24	3/4	500,000	600	0314C0824V	0314W0824V	13.4
26	32	3/4	500,000	600	0314C0832V	0314W0832V	13.4

Replacement Sealed Beam Information

- | | |
|---------------------|--|
| 7 Inch Head | 8 Inch Head |
| 12 Volt: 043300312V | 12 Volt: 043300412V |
| 24 Volt: 043300324V | 24 Volt: 043300424V |
| 32 Volt: 043300332V | 32 Volt: Order 24V Sealed Beam. If converting from another voltage, order Internal Dropping Resistor (0314R3299A) in addition to the bulb. |

SOLAR-RAY® SEALED BEAM SEARCHLIGHTS

Figs. 0305 & 0313 Series

- Bronze Base, Brass Body
- Chrome Plated or White PERKO•KOTE Powder Coating
- For 12, 24 or 32 Volts

Dimensions (Inches)

A	B	C	D	G	H
8	8-1/2	10	7	2	2-1/8

TECH INFO

Voltage	Wattage	Approximate Candlepower	Sealed Beam Range Miles	Sealed Beam Catalog No.
12	100	250,000	5/8	043300312V
24	450	470,000	3/4	043300324V
32	200	260,000	5/8	043300332V

ORDERING INFO - FIGS. 0305 & 0313 SEARCHLIGHT HEADS

Voltage	Head Only Chrome Plated For Lever Control	Head Only White PERKO•KOTE For Lever Control	Head Only Chrome Plated For Wheel or Lever/Gear Control	Head Only White PERKO•KOTE For Wheel or Lever/Gear Control
12	0305H12CHR	0305H12WHT	0313H12CHR	0313H12WHT
24	0305H24CHR	0305H24WHT	0313H24CHR	0313H24WHT
32	0305H32CHR	0305H32WHT	0313H32CHR	0313H32WHT

Nominal Weight - 20 lbs.

Fig. 0354 Front Bezel with Glass for Figs. 0305 & 0313, Specify Chrome or White.
 Fig. 0355 Rear Cover for Figs. 0305 & 0313, Specify Chrome or White.

Figs. 0851, 0852 & 0969 - Control Assemblies

- Stainless Steel Tubes with Chrome Plated Fittings
- Lever Control Fits Fig. 0305 Head Assemblies.
- Wheel and Lever/Gear Controls Fit Fig. 0313 Head Assemblies.

ORDERING & TECH INFO

Control Length Inches		"E" Lever Control	"E" Lever/Gear Control	"F" Wheel Control	Nominal Weight Pounds E/E/F
"E"	"F"	For 0805	For 0313	For 0313	
8-1/2	7-1/2	0851000*	0969000**	0852000***	3.4/4.1/5.2
15-1/2	14-1/2	08510A0	09690A0	08520A0	4.1/4.9/6.0
22-1/2	21-1/2	08510B0	09690B0	08520B0	5.0/5.8/6.9
29-1/2	28-1/2	08510C0	09690C0	08520C0	5.8/6.5/7.6

Maximum Ceiling Thickness,

*0851: 4-1/2 Inches.

**0969: 3-1/2 Inches.

***0852: 3 Inches.

Custom Lengths Available by Special Order.



Fig. 0305
For Lever Control



Fig. 0313
For Wheel or Lever/Gear Control

Fig. 0969
Lever/Gear Control
Fits 0313 Head

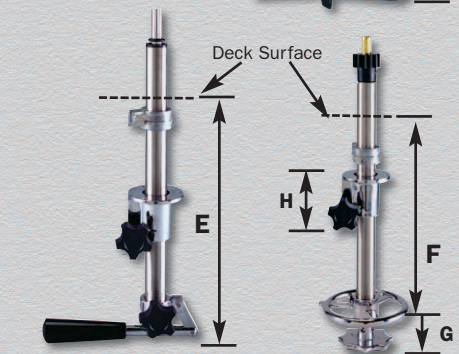

Fig. 0851
Lever Control
Fits 0305 Head

Fig. 0852
Wheel Control
Fits 0313 Head

SOLAR-RAY® SEALED BEAM SEARCHLIGHTS

CE

3



Fig. 0535



Fig. 0534



Fig. 0538



Sealed Beam Included

Figs. 0534, 0535 & 0538 - Searchlights

CONSTRUCTION:

- Chrome Plated Brass Head
 - For 12, 24 or 32 Volts
- Tungsten or Halogen Bulb
 - Switch in Head

Fig. 0534 - Deck Control

- Chrome Plated Bronze Base
- 7 Inch Sealed Beam Bulb Included

Fig. 0535 - Pilot House Control

- Chrome Plated Bronze Base
- 7 Inch Sealed Beam Bulb Included
- Lever Handle Controls both Horizontal and Vertical Movement
 - Control Length: 7-1/2 Inches
- Maximum Ceiling Thickness: 4-1/2 Inches

Fig. 0538 - Deck Control

- Chrome Plated Brass Base
- 4-1/2 Inch Sealed Beam Bulb Included

ORDERING & TECH INFO

Voltage	O.D. Bulb Inches	Approx. Range Miles	Beam Candlepower	Wattage	Height Overall Inches	Base Dimension Inches	Catalog Number	Ship Wt. Carton Lbs. Std Pkg.
12	7	5/8	250,000	100	12-1/2	4-7/8 x 3-1/8	053400312V	9.0
24	7	3/4	470,000	450	12-1/2	4-7/8 x 3-1/8	053400324V	9.0
32	7	5/8	260,000	200	12-1/2	4-7/8 x 3-1/8	053400332V	9.0
12	7	5/8	250,000	100	—	4-7/8 x 3-1/8	053500312V	9.0
24	7	3/4	470,000	450	—	4-7/8 x 3-1/8	053500324V	9.0
32	7	5/8	260,000	200	—	4-7/8 x 3-1/8	053500332V	9.0
12	4-1/2	1/4	50,000	30	7-1/2	3-1/2 O.D.	0538000CHR	1.5
12	4-1/2	1/3	100,000	50	7-1/2	3-1/2 O.D.	0538H00CHR*	1.5

*NOTE: "H" in the Catalog Number Designates a Halogen Bulb.

CE

Fig. 0440 - Removable Hand Held Deck Control Searchlight



Fig. 0440 No. 3 Shown



Sealed Beam Included

CONSTRUCTION:

- Chrome Plated Brass Head and Base
 - For 12 or 32 Volts
- 4-1/2 or 7 Inch Sealed Beam Bulb Included
- 8 Feet of Coiled Cord & Cigarette Lighter Plug
 - Watertight Deck Connection
 - Switch in Head

ORDERING & TECH INFO

Voltage	O.D. Bulb Inches	Approx. Range Miles	Beam Candlepower	Wattage	Height Overall Inches	Catalog Number	Ship Wt. Carton Lbs. Std Pkg.
12	4-1/2	1/4	50,000	30	7-1/2	044000112V	2.4
12	4-1/2	1/3	100,000	50	7-1/2	0440H0112V*	2.4
12	7	5/8	250,000	100	10	044000312V	5.5
32	7	5/8	260,000	200	10	044000332V	5.5

Base Diameter, 2-1/8 Inches.

*NOTE: "H" in the Catalog Number Designates a Halogen Bulb.

SPARE SEALED BEAM ORDERING INFORMATION

- 4-1/2 Inch Sealed Beam: 043300112V.
- 4-1/2 Inch Halogen Sealed Beam: 043500112V.
- 7 Inch Sealed Beam (12 Volt): 043300312V.
- 7 Inch Sealed Beam (24 Volt): 043300324V.
- 7 Inch Sealed Beam (32 Volt): 043300332V.

Replacement Base: 0494000CHR

SURFACE MOUNT L.E.D. UNDERWATER LIGHTS



- EASY INSTALLATION
- 50,000 HOUR. L.E.D. RATED LIFE
- BLUE OR WHITE L.E.D. OPTIONS
- SINGLE OR DOUBLE PACK



4

TRADITIONAL THRU-HULL MOUNT UNDERWATER LIGHTS

- CHROME OR PLAIN BRONZE
- INCANDESCENT OR L.E.D.
- LARGE LIGHTS FOR LARGE BOATS
- SMALL LIGHTS FOR SMALL BOATS
- CHANGEABLE BEAM & COLOR OPTIONS
- IGNITION PROTECTED



UNDERWATER LIGHTING - L.E.D. SURFACE MOUNT FOR TRIM TABS



Fig. 0178 - L.E.D. Surface Mount Trim Tab Underwater Light

4



Fig. 0178

Mounted on Trim Tab
(Not Included)

CONSTRUCTION:

- Non-Corrosive Molded Black Polymer Housing
 - White or Blue L.E.D.'s
- 8 Feet of 18 AWG Marine Grade Electrical Cable
 - Removable brackets can be positioned for horizontal or vertical mounting applications
- Trim Tab mounting allows for adjustability of the beam as the tab moves up and down
 - Mounting riser included in DP Package for use with lipped trim tabs.
- L.E.D.'s provide Longer Life, Less Heat and Use 1/10th the Energy of Standard Lights



Horizontal Mount



Vertical Mount



Shown with Mounting Riser



White or Blue L.E.D.'s



Shown on Trim Tab in the water



ORDERING INFO

Description	L.E.D. Color	Dealer Pkg. 1 Pkg.	Std. Pkg. - 1 Pc. OEM Bulk Pkg. 10 Pcs.	Ship Wt. Carton Lbs. DP/STD/OEM Bulk
Trim Tab Mount 1-Pk	White	0178DP1WHT	0178001WHT	0.7/0.7/5.0
Trim Tab Mount 2-Pk	White	0178DP2WHT	_____	1.8
Trim Tab Mount 1-Pk	Blue	0178DP1BLU	0178001BLU	0.7/0.7/5.0
Trim Tab Mount 2-Pk	Blue	0178DP2BLU	_____	1.8

TECH INFO

- 12 Volt, 7.0W
- 75 Lumens, 324 C.P. - White
- 27 Lumens, 207 C.P. - Blue
- L.E.D. Beam: 15°
- Lab Rated L.E.D. Life: 50,000 Hrs.
- Dimensions: 4-1/8" x 1-5/16" x 1-1/4"
- Bolt Size: 8/32 P.H.

Available for Retail Sale in Single or Double Pack

UNDERWATER LIGHTING - L.E.D. SURFACE MOUNT



Fig. 0181 - Surface Mount L.E.D. Underwater Light

CONSTRUCTION:

- Lightweight Molded Polymer Body
- White or Blue L.E.D.s
- Affordable, Rugged & Reliable
- Low Draw, Long Life L.E.D.
- Installs Easily with 3 Screws

**50,000 Hr.
Rated
L.E.D. Life**



**Fig. 0181
Profile**



Available for Retail Sale in Single or Double Pack



Fig. 0181 White

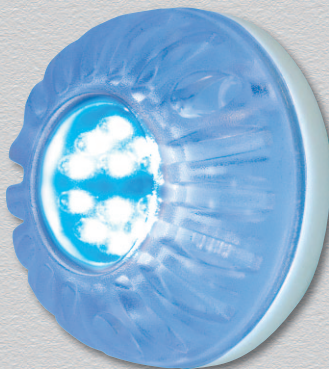

Fig. 0181 Blue



**Installs with just
3 Screws (Not Included)**

ORDERING INFO

Description	L.E.D. Color	Dealer Pkg. 5 Pkgs.	OEM Bulk Pkg. 10 Pcs.	Ship Wt. Carton Lbs. DP/OEM Bulk
Surface Mount 1-Pk	White	0181DP1WHT	0181001WHT	3.4/4.6
Surface Mount 2-Pk	White	0181DP2WHT	_____	5.7
Surface Mount 1-Pk	Blue	0181DP1BLU	0181001BLU	3.4/4.6
Surface Mount 2-Pk	Blue	0181DP2BLU	_____	5.7

TECH INFO

- 12 Volt, 4.5W
- 50 Lumens, 216 C.P. - White
- 18 Lumens, 138 C.P. - Blue
 - L.E.D. Beam: 15°
- Lab Rated L.E.D. Life: 50,000 Hrs
 - Projection: 1-1/4"
 - Overall Dia.: 2-7/8"
 - Screw Size: #8 R.H.

UNDERWATER LIGHTING - L.E.D. THRU-HULL MOUNT



4

Fig. 0176 - L.E.D. Thru-Hull Mount Underwater Light

CONSTRUCTION:

- Polished or Chrome Plated Bronze Body and Mounting Ring
 - 10 Feet of 16/2 Electrical Cable
- Safety Seal Design Prevents Water Intrusion in the Event of Glass Breakage
 - Terminal for Bonding Wire
- L.E.D.'s provide Longer Life, Less Heat and Use 1/10th the Energy of Standard Lights
 - Ignition Protected



Fig. 0176

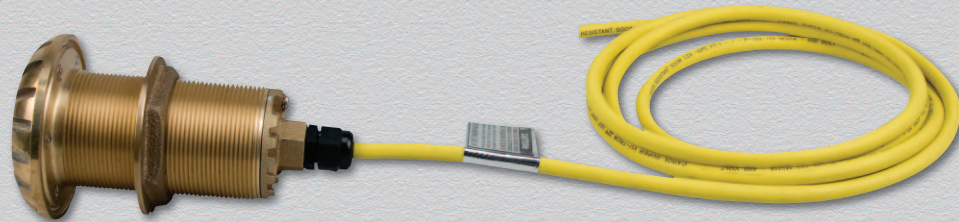

**Fig. 0078
L.E.D.**

ORDERING INFO			TECH INFO
Description	Dealer Pkg. 1 Pc. per Box	Ship Wt. Carton Lbs. Dealer Pkg.	<ul style="list-style-type: none"> • 12 Volt, 5W, 0.4 Amps <ul style="list-style-type: none"> • Bulb 20° Beam • 85 Lumens • Lab Rated Bulb Life: 50,000 Hrs • Length Overall: 6-3/4" <ul style="list-style-type: none"> • Flange Dia.: 3-3/4" • Mounting Hole Dia.: 2-3/8"
Polished Bronze	0176DP3PLB	5.0	
Chrome Plated	0176DP3CHR	5.0	
Description	Std. Pkg. 1 Pc. per Box	Ship Wt. Carton Lbs. Std. Pkg.	
Polished Bronze	0176003PLB	4.6	
Chrome Plated	0176003CHR	4.6	

SPARE PARTS ORDERING INFORMATION

Replacement 12V L.E.D.: 0078DP112V
 Replacement Lens Kit (includes O-Rings): 0174DP1LNS
 IGNITION PROTECTED Power Relay for use with up to 4 lights: (12 volt) 0061DP1RLY

UNDERWATER LIGHTING - INCANDESCENT THRU-HULL MOUNT

Fig. 0174 - Thru-Hull Mount Underwater Light

CONSTRUCTION:

- Polished or Chrome Plated Bronze Body and Mounting Ring
- Two Bulb Options:
 - 25° Beam Bulb (3000 CB Candle Power)
 - 40° Beam Bulb (1700 CB Candle Power)
- 10 Feet of 16/2 Electrical Cable
- Safety Seal Design Prevents Water Intrusion in the Event of Glass Breakage
- Terminal for Bonding Wire
- Includes Green & Blue Lens Filters
- Ignition Protected

Color Lens Filters



Included in Package



4



Fig. 0174

Easy Access for Bulb Changes

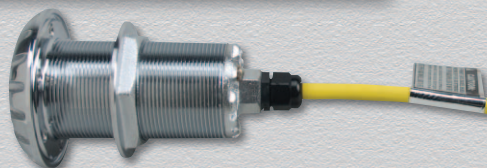

ORDERING INFO

Description	Bulb Beam	Dealer Pkg. 1 Pc. per Box	Ship Wt. Carton Lbs. Dealer Pkg.
Polished Bronze	25° & 40°	0174DP3PLB*	5.1
Chrome Plated	25° & 40°	0174DP3CHR*	5.1

Description	Bulb Beam	Std. Pkg. 1 Pc. per Box	Ship Wt. Carton Lbs. Std. Pkg.
Polished Bronze	25°	0174003PLB	4.6
Polished Bronze	40°	0174004PLB	4.6
Chrome Plated	25°	0174003CHR	4.6
Chrome Plated	40°	0174004CHR	4.6

TECH INFO

- 12 Volt, 50W, 4.1 Amps
- 2 Bulb Options:
 - 25° & 40° Beam
 - 800 Lumens
- Lab Rated Bulb Life: 5000 Hrs**
- Length Overall: 6-3/4"
- Flange Dia.: 3-3/4"
- Mounting Hole Dia.: 2-3/8"



Fig. 0061 Ignition Protected Relay



Fig. 0077 Halogen Bulbs
50 Watt - 25° Beam
50 Watt - 40° Beam

SPARE PARTS ORDERING INFORMATION

12 Volt, 50 Watt, 25° Beam Bulb: 0077DP112V
 12 Volt, 50 Watt, 40° Beam Bulb: 0077DP212V
24 Volt Bulb Options Available
 Blue & Green Lens Filter Kit & 2 O-Rings: 0174DP099A
 Replacement Lens Kit (includes O-Ring): 0174DP1LNS
 IGNITION PROTECTED Power Relay for use with up to 4 lights:
 (12 volt) 0061DP1RLY or (24 volt) 0061DP2RLY

* Dealer Package includes both bulbs
 ** In Accordance with ANSI Standards

UNDERWATER LIGHTING - INCANDESCENT SPACE SAVER THRU-HULL MOUNT



Fig. 0175 - Space Saver Thru-Hull Mount Underwater Light

Color Lens Filters



4



- Polished or Chrome Plated Bronze Body and Mounting Ring
 - 10 Feet of 18/2 Electrical Cable
- Safety Seal Design Prevents Water Intrusion in the Event of Glass Breakage
 - Terminal for Bonding Wire
- Includes Green & Blue Lens Filters
 - Ignition Protected

CONSTRUCTION:



Fig. 0175



Proportional Relationship between Figs. 0174 & 0175

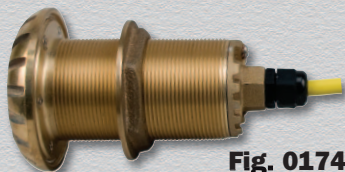

Mounting Hole Dia.: 2-3/8"

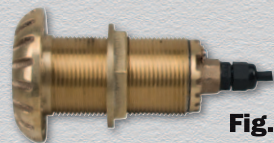

Mounting Hole Dia.: 1-3/4"

ORDERING INFO

		Ship Wt. Carton Lbs. Dealer Pkg.
Description	Dealer Pkg. 1 Pc. per Box	
Polished Bronze	0175DP3PLB	2.3
Chrome Plated	0175DP3CHR	2.3
Description	Std. Pkg. 1 Pc. per Box	Ship Wt. Carton Lbs. Std. Pkg.
Polished Bronze	0175003PLB	2.1
Chrome Plated	0175003CHR	2.1

TECH INFO

- 12 Volt, 35W, 2.9 Amps
 - Bulb 30° Beam
 - 550 Lumens
- Lab Rated Bulb Life: 3500 Hrs.*
- Length Overall: 5-1/4"
- Flange Dia.: 2-7/8"
- Mounting Hole Dia.: 1-3/4"

SPARE PARTS ORDERING INFORMATION

12 Volt, 35 Watt, 30° Beam Bulb: 0080DP112V
24 Volt Bulb Options Available
 Blue & Green Lens Filter Kit & 2 O-Rings: 0175DP099A
 Replacement Lens Kit (includes O-Ring): 0175DP1LNS
 IGNITION PROTECTED Power Relay for use with up to 4 lights:
 (12 volt) 0061DP1RLY or (24 volt) 0061DP2RLY



Fig. 0080 Halogen Bulb
35 Watt - 30° Beam

* In Accordance with ANSI Standards



Fig. 0202 - L.E.D. Straight Docking Light
Fig. 0203 - L.E.D. Angled Docking Light

CONSTRUCTION:

- Marinium Alloy or Chrome Plated Bronze
- Angled or Straight Light Direction
- Low Draw, Long Life L.E.D. Lighting
- 12 Volt L.E.D.

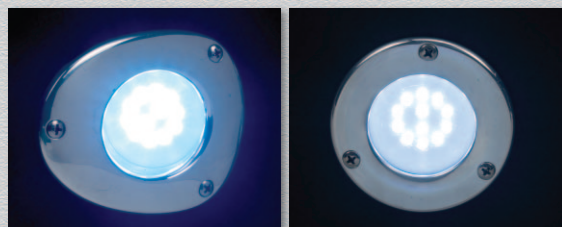

Fig. 0203
Angled

Fig. 0202
Straight



Fig. 0203
Angled



Fig. 0202
Straight

4

ORDERING INFO

Light Direction	Material	Projection Inches	Dealer Pkg. 1 Pair per Pkg.	OEM Bulk Pkg. 5 Pairs	Ship Wt. Carton Lbs. DP/OEM Bulk
Straight	Chr. Bronze	1/2	0202DP0CHR	0202000CHR	1.7/7.0
Straight	Marinium	1/2	0202DP0MAR	0202000MAR	1.2/5.5
Angled	Chr. Bronze	1/2	0203DP0CHR	0203000CHR	2.9/13.2
Angled	Marinium	1/2	0203DP0MAR	0203000MAR	1.4/8.0

TECH INFO

- 12 Volt, 4.5W
 - L.E.D. Beam: 15°
 - Lab Rated L.E.D. Life: 50,000 Hrs
 - Screw Size: #6
- Dimensions:**
 Angled: 4-1/8" x 3-3/8"
 Straight: 3-1/8" O.D.

Fig. 0606 - White L.E.D. Utility Light
Fig. 0607 - White/Red L.E.D. Utility Light

CONSTRUCTION:

- Chrome Plated Brass Frame
- Low Draw, Long Life L.E.D. Lighting
- 12 Volt L.E.D.



Fig. 0606
White



Fig. 0607
White/Red

ORDERING INFO

L.E.D. Color	Dealer Pkg. 1 Card 1 Pc. per Card	OEM Bulk Pkg. 10 Pcs.	Screw Size	Ship Wt. Carton Lbs. DP/OEM Bulk
White	0606DP0CHR	0606000CHR	6	0.7/2.5
White/Red	0607DP0CHR	0607000CHR	6	0.7/2.6

TECH INFO

- L.E.D.: 12 Volt, 4W
 - Lab Rated L.E.D. Life: 50,000 Hrs.
- Base Dimensions:**
 7-1/4" x 1-1/2"

UTILITY LIGHTS

NEW Item



Available by
Oct. 2010

4

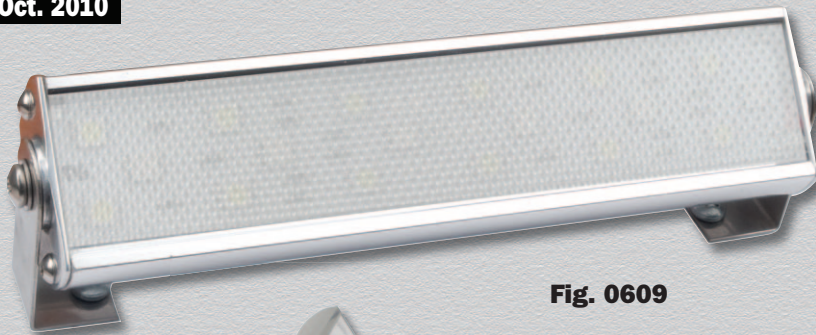

Fig. 0609

Fig. 0609 - L.E.D. Swivel Berth Lights

CONSTRUCTION:

- Aluminum and Stainless Steel Housing
- Stainless Steel Mounting Brackets
 - 12 Volt L.E.D.'s with White or Dual (White/Red) Light Options
 - Diffused Cover



ORDERING & TECH INFO

L.E.D. Color	Projection Inches	Nominal Dimensions Inches	Std. Pkg. 1 Pc.	Screw Size	Ship Wt. Carton Lbs. OEM Bulk Pkg.
White	1-1/2	1-1/2 x 6-3/8	0609W0012V	8	1.1
White/Red	1-1/2	1-1/2 x 6-3/8	0609WR012V	8	1.1

Fig. 1146 - "Reduced Glare" Design Cockpit Light



Fig. 1146 Chrome

CONSTRUCTION OPTIONS:

- Chrome Plated Brass or Stainless Steel with Black Polymer Base
 - White Polymer with Black Polymer Base
 - 12, 24 or 32 Volt Bulb Included
- Designed to Direct 80% of the Light Downward, Thus Reducing Cockpit Glare



Fig. 1146 White

ORDERING INFO

Finish	Voltage	Dealer Pkg. 5 Cards 1 Pc. per Card	OEM Bulk Package 25 Pcs.	Ship Wt. Carton Lbs. DP/OEM Bulk
Chrome	12	1146DP112V	114600112V	1.4/5.1
Chrome	24	1146DP224V	114600224V	1.4/5.1
Chrome	32	1146DP332V	114600332V	1.4/5.1
Stainless	12	1146DP1STS	1146001STS	1.4/5.1
Stainless	24	1146DP2STS	1146002STS	1.4/5.1
Stainless	32	1146DP3STS	1146003STS	1.4/5.1
White	12	1146DP1WHT	1146001WHT	1.2/4.1
White	24	1146DP2WHT	1146002WHT	1.2/4.1
White	32	1146DP3WHT	1146003WHT	1.2/4.1

TECH INFO

12, 24 or 32 Volt
O.D. Overall: 3"
Depth: 1"
Installs in 2-1/8" Dia. Hole
Screw Size: #8

SPARE PARTS ORDERING INFORMATION

12 Volt Bulbs (2 Per Card): 0070DPOCLR. Socket Assembly: 114600099B.
24 Volt Bulbs (2 Per Card): 0067DP1CLR. Lens with Gasket: 1146DP099A.
32 Volt Bulbs (2 Per Card): 0070DP2CLR. Mounting Flange: 094600099C

ALSO AVAILABLE IN



Contact Factory

Fig. 1156 - L.E.D. Ceiling Mount Utility Light

CONSTRUCTION:

- Chrome Plated Brass Bezel & White Polymer Base
- Stainless Steel Bezel & White Polymer Base or
- White PERKO•Kote Brass & White Polymer Base
- Uses Less than Half the Energy Draw of Standard Lights!



Low profile side view

Fig. 1156

ORDERING INFO

	Dealer Pkg. 5 Cards	OEM Bulk Package	Ship Wt. Carton Lbs. DP/OEM Bulk
Finish	1 Pc. per Card	10 Pcs.	
Chrome	1156DP112V	115600112V	2.5/4.5
Stainless Steel	1156DP1STS	1156001STS	2.5/4.5
White	1156DP1WHT	1156001WHT	2.5/4.5

TECH INFO

12 Volt L.E.D.
O.D. Overall: 3"
Installs in 2-1/8"
Dia. Hole
Screw Size: #8

Figs. 0137/0140 - Surface Mount Utility Lights

Fig. 0145 - L.E.D. Surface Mount Utility Light

CONSTRUCTION:

- Fig. 0137** - Molded Black Polymer
 - Shielded Light Cover
- Figs. 0140 & 0145** - Molded White Polymer
 - Diffused Light Cover

Figs. 0137 and 0140: 12 Volt, 1 Watt Bulb Included



Fig. 0137



Fig. 0140



Fig. 0145

ORDERING INFO

Dealer Pkg. 10 Cards 1 Pc. per Card	OEM Bulk Pkg. 100 Pcs.	Ship Wt. Carton Lbs. DP/OEM Bulk
0137DP0BLK	0137000BLK	0.7/2.2
0140DP0NYN	0140000NYN	0.7/2.0
0145DP0NYN	0145000NYN	0.7/2.0

TECH INFO

12 Volt or
12 Volt L.E.D.
Length Overall: 1-7/8"
Width: 9/16"
Screw Size: #6



Fig. 1149 - Clear Back Utility Light

CONSTRUCTION:

- Chrome Plated Brass or Stainless Steel
- Clear Polymer Back
- 12 Volt Bulb Included,
24 or 32 Volt with Bulb Change

The clear back allows light to shine both inside and outside of the mounting location. Ideal for mounting on center consoles, storage lockers, cabinets and electronics boxes.

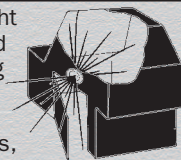

Diagram of center console mt.



Back



ORDERING INFO

	Dealer Pkg. 5 Cards	OEM Bulk Package	Ship Wt. Carton Lbs. DP/OEM Bulk
Finish	1 Pc. per Card	25 Pcs.	
Chrome	1149DP112V	114900112V	1.4/5.1
Stainless Steel	1149DP1STS	1149001STS	1.4/5.1

TECH INFO

12 Volt
O.D. Overall: 3"
Depth: 1"
Installs in 2-1/8"
Dia. Hole
Screw Size: #8

SPARE PARTS ORDERING INFORMATION

12 Volt Bulbs (2 Per Card): 0070DP0CLR. Socket Assembly: 114900099B.
24 Volt Bulbs (2 Per Card): 0067DP1CLR. Lens with Gasket: 1146DP099A.
32 Volt Bulbs (2 Per Card): 0070DP2CLR. Mounting Flange: 094600099C

Fig. 1149

INCANDESCENT, L.E.D. FLUSH MOUNT AND ADJUSTABLE UTILITY LIGHTS



4

Fig. 1044 - Incandescent Light With Snap on Front Cover
Fig. 1074 - L.E.D. Utility Light with Snap on Front Cover

Uses Less than Half the Energy Draw of Standard Lights

CONSTRUCTION:

- Black or White Molded Polymer
- Snap-On Front Cover Conceals Mounting Screws
- Diffusion Lens
- Flush Mounting
- Easy Installation



Fig. 1074
White

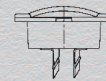

Fig. 1044
Black

12 Volt, 3 Watt Incandescent Bulb or 12 Volt L.E.D.

No. 1 Supplied with 1/4" Spade Connectors (Fig 1044 only)

No. 2 Supplied with 7" Pig Tail Wire Leads



Spade Connectors (#1 Style)



Pig Tail Leads (#2 Style)

ORDERING INFO

		Dealer Pkg. 10 Cards 1 Pc. per Card	OEM Bulk Pkg. 100 Pcs.	Ship Wt. Carton Lbs. DP/OEM Bulk
Color	Black Spade	1044DP1BLK	1044001BLK	1.1/6.0
	Black Pig Tail	1044DP2BLK	1044002BLK	1.2/7.2
	White Spade	1044DP1WHT	1044001WHT	1.1/6.0
	White Pig Tail	1044DP2WHT	1044002WHT	1.2/7.2
		Dealer Pkg. 10 Cards 1 Pc. per Card	OEM Bulk Pkg. 25 Pcs.	Ship Wt. Carton Lbs. DP/OEM Bulk
Color	Black Pig Tail	1074DP2BLK	1074002BLK	1.2/2.0
	White Pig Tail	1074DP2WHT	1074002WHT	1.2/2.0

TECH INFO

Fig 1044: 12 Volt
 Fig 1074: 12 Volt L.E.D.
 O.D. Overall: 3"
 Depth: 1"
 Installs in 2-1/8" Dia. Hole
 Screw Size: #8



**Std. Incandescent
Bulb Version**



**L.E.D.
Version**

SPARE PARTS ORDERING INFORMATION

Bulbs for Fig. 1044 (2 Per Card): 1044DP099A.

Fig. 1254 - Adjustable Utility Light

CONSTRUCTION:

- Chrome Plated Zinc Alloy
- Shield Swivels to Change Position
- 12 Volt, 7 Watt Bulb Included



Fig. 1254

ORDERING INFO

Dealer Pkg. 5 Cards 1 Pc. per Card	Ship Wt. Carton Lbs. Dealer Pkg.
1254DPOCHR	2.5

TECH INFO

12 Volt
 O.D. Overall: 2-5/8"
 Length Neck: 3/4"
 O.D. Neck: 7/8"
 Screw Size: #6

SPARE PARTS ORDERING INFORMATION

Bulbs (2 per card): 0337011DP. Socket: 0024DP1.

BULKHEAD AND SURFACE MOUNT LIGHTS

Fig. 0217 - Bulkhead Light Fixture

CONSTRUCTION:

- Chrome Plated Zinc Alloy
- Medium Screw Socket and Turn Switch

For Systems up to 50 Volts - Bulb Not Included

ORDERING & TECH INFO

Dimensions Base Inches	Projection Less Bulb Inches	Dealer Pkg. - 5 Cards 1 Pc. per Card	Screw Size	Ship Wt. Carton Lbs. Dealer Pkg.
2-1/2 x 1-3/4	2-5/8	0217DPOCHR	6 R.H.	3.0

SPARE PARTS ORDERING INFORMATION

Bulb Socket Assembly with Switch and Knob: 0223. Order Perko Bulb 0340, See Page 127.



Fig. 0217

4

Fig. 1303 - Bulkhead Light Fixture

CONSTRUCTION:

- Black or White Molded Polymer

L.E.D. Version - 12 Volt

Incandescent Version:

For Systems up to 50 Volts

Bulb Not Included

- Size No. 1 Has Double Contact Bayonet Socket Will Accommodate a Bulb Up To 24 Watts
- Size No. 2 Has Medium Screw Socket Will Accommodate a Bulb Up To 40 Watts

Fig. 1303
White



Fig. 1303
Black



NEW
LED
Version

ORDERING & TECH INFO

Type	Dimensions Wall Plate Inches	Normal Projection Inches	Length Shade Inches	Black		White		Screw Size	Ship Wt. Carton Lbs. Std. Pkg./OEM Bulk
				Std. Pkg. - 1 Pc. OEM Pkg. - 10 Pcs.	Std. Pkg. - 1 Pc. OEM Pkg. - 10 Pcs.	Std. Pkg. - 1 Pc. OEM Pkg. - 10 Pcs.	Std. Pkg. - 1 Pc. OEM Pkg. - 10 Pcs.		
Incandescent	4-1/2 x 3-1/4	4-3/8	3	1303001BLK	1303001WHT	8	0.4/4.0		
Incandescent	4-1/2 x 3-1/4	5	4-1/2	1303002BLK	1303002WHT	8	0.5/4.4		
L.E.D.	4-1/2 x 3-1/4	5	4-1/2	1303L00BLK*	1303L00WHT*	8	0.5/4.4		

*L.E.D. Version OEM. Pkg. 1 pc.

SPARE PARTS ORDERING INFORMATION

Refer to Page 127 for Bulb Selection: Size 1: 0337, Size 2: 0340 Switch: 0701DP.

Fig. 0318 - Dual Voltage Surface Mount Light

CONSTRUCTION:

- White Translucent Polymer Cover
- White PERKO•KOTE Cast Zinc Alloy Base with Integral Junction Box
- Dual Voltage, For 12 and 120 Volts
- Double Contact Bayonet Sockets
- Complete With Two 12 Volt, 11 Watt and Two 120 Volt, 15 Watt Bulbs

ORDERING INFO

Dealer Pkg. 5 Cards 1 Pc. per Card	OEM Bulk Pkg. 10 Pcs.	Ship Wt. Carton Lbs. DP/OEM Bulk
0318DP	0318A00	9.5/16

TECH INFO

12 & 120 Volt
Length: 9-3/4"
Width: 3-1/2"
Depth: 1-7/8"
Screw Size: #10



Fig. 0318

SPARE PARTS ORDERING INFORMATION

12 Volt Bulbs (2 per card): 0337012DP. Socket: 0024DP1.
120 Volt Bulbs (2 per card): 0337023DP. Globe: 0318A0099D.
Switches with Square Buttons (1 Each High and Low): 0318A0099E.

DIMMER CAPABLE L.E.D. DOME LIGHTS



- Fig. 1355 - L.E.D. Dome Light (No On/Off Switch)
- Fig. 1356 - L.E.D. Dome Light with On/Off switch (12 or 24 Volt)
- Fig. 1357 - L.E.D. Dome Light with Trim Ring (No Switch)
- Fig. 1358 - L.E.D. Dome Light with Dimmer Switch

CONSTRUCTION:

- Surface Mount
- Chrome Plated Zinc Alloy or White PERKO•KOTE
- Clear Polymer Lens
- 12 or 24 Volt L.E.D.s Draw Less than 10 Watts
- Screw Size No. 8 R.H.
- Depth Overall 1"

4



Fig. 1355
Without Switch
(White Shown)



Fig. 1356
With On/Off Switch
(Chrome Shown)



Fig. 1357
With Trim Ring
(White Shown)



Fig. 1358
With Dimmer Switch
(Chrome Shown)

ORDERING & TECH INFO

Description	Dimmer Capable	Voltage	L.E.D.s & Wattage	Dimensions O.D. Inches	Dealer Pkg. 5 Cards 1 Pc. per Card	OEM Bulk Pkg. 10 Pcs.	Ship Wt. Carton Lbs. DP/OEM Bulk
Chrome No Switch	w/Wall Switch*	12	3-3 Watt	3-5/8	1355DPOCHR	1355000CHR	4.1/8.1
White No Switch	w/Wall Switch*	12	3-3 Watt	3-5/8	1355DPOWHT	1355000WHT	4.1/8.1
Chrome On/Off Switch	w/Wall Switch*	12	3-3 Watt	3-5/8	1356DPOCHR	1356000CHR	4.2/8.2
Chrome Plated On/Off Switch	w/Wall Switch*	24	3-1 Watt	3-5/8	1356DP2CHR	1356002CHR	4.2/8.2
White On/Off Switch	w/Wall Switch*	12	3-3 Watt	3-5/8	1356DPOWHT	1356000WHT	4.2/8.2
White On/Off Switch	w/Wall Switch*	24	3-1 Watt	3-5/8	1356DP2WHT	1356002WHT	4.2/8.2
Chrome w/Trim Ring, No Switch	w/Wall Switch*	12	3-3 Watt	4-1/2**	1357DPOCHR	1357000CHR	5.0/9.8
White w/Trim Ring, No Switch	w/Wall Switch*	12	3-3 Watt	4-1/2**	1357DPOWHT	1357000WHT	5.0/9.8
Chrome with Dimmer Switch	Built in	12	3-1 Watt	3-5/8	1358DPOCHR	1358000CHR	4.2/8.3
White with Dimmer Switch	Built in	12	3-1 Watt	3-5/8	1358DPOWHT	1358000WHT	4.2/8.3

* Note: Wall switch not included ** Trim Ring Included



- Fig. 1157 - Surface Mount L.E.D. Dome Light

CONSTRUCTION:

- Chrome Plated Brass or White PERKO•KOTE
- Clear Polymer Lens
- 12 Volt L.E.D.s Draw Less than 4 Watts
- Dimmer Capable with External Switch (Not Included)

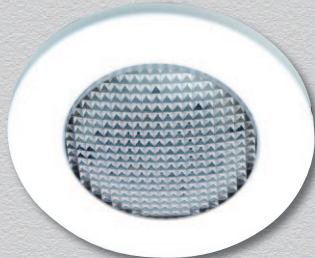

Fig. 1157
(White Shown)

ORDERING INFO

Finish	Dealer Pkg. 5 Cards 1 Pc. per Card	OEM Bulk Package 10 Pcs.	Ship Wt. Carton Lbs. DP/OEM Bulk
Chrome	1157DP1CHR	1157001CHR	2.5/4.5
White	1157DP1WHT	1157001WHT	2.5/4.5

TECH INFO

- 12 Volt
- Three 1 Watt L.E.D.s
- O.D. Overall: 3-1/8"
 - Depth: 1"
- Installs in 2-1/8" Dia. Hole
 - Screw Size: #8



Please contact the factory for availability of devices for applications that require a Multiple Light Wall Dimmer Switch for the lights listed on this page.

Fig. 0300 - Surface Mount Dome Light
Fig. 1253 - Exterior Surface Mount Dome Light



CONSTRUCTION:

Fig. 0300 - Chrome Plated Zinc Alloy

Fig. 1253 - Ivory PERKO•KOTE Zinc Alloy

- Double Contact Bayonet Socket
- Black Vinyl Mounting Gasket
- Push Switch with Water Resistant Boot
- 12 Volt Bulb Included



Fig. 0300



Fig. 1253

4

ORDERING & TECH INFO

O.D. Lens Inches	O.D. Base Inches	Depth Overall Inches	Wattage of Bulb Supplied	Maximum Wattage	Dealer Pkg. - 5 Cards 1 Pc. per Card	OEM Bulk Pkg. 10 Pcs.	Screw Size	Ship Wt. Carton Lbs. DP/OEM Bulk
3	3-3/4	1-1/2	7	11	0300DP0CHR	0300000CHR*	10 R.H.	3.2/10.6
4	5	1-7/8	11	17	0300DP1CHR	0300001CHR	10 R.H.	4.9/8.7
5	6	2	17	17	0300DP2CHR	0300002CHR	12 R.H.	6.9/11.8
4	5	1-7/8	11	17	1253DP1WHT	1253001WHT	10 R.H.	4.8/8.5
5	6	2	17	17	1253DP2WHT	1253002WHT	12 R.H.	6.7/12.0

*OEM Bulk Pkg., 20 Pcs.

SPARE PARTS ORDERING INFORMATION

Bulbs (2 per card) for Size #0: 0337011DP. Switch: 0701DP.
 Bulbs (2 per card) for Size #1: 0337012DP. Socket: 0024DP1.
 Bulbs (2 per card) for Size #2: 0337013DP. Lens: 0257DP, Specify Size.

NOTE: To Use Figs 0300 (#1 or #2) & 1253 in a 24 Volt System, Order Replacement Bulb (1 per card): 0337014DP.

Fig. 1263 - Exterior Surface Mount Dome Light with Red & White Bulbs



CONSTRUCTION:

- Ivory PERKO•KOTE Zinc Alloy
- Three Position Toggle Switch
- 12 Volt Bulbs Included



Fig. 1263

ORDERING INFO

Wattage of Bulbs Supplied	Maximum Wattage	Dealer Pkg. 5 Cards 1 Pc. per Card	OEM Bulk Pkg. 10 Pcs.	Ship Wt. Carton Lbs. DP/OEM Bulk
11/18	11/18	1263DP1WHT	1263001WHT	5.0/9.0

TECH INFO

- 12 Volt
- O.D. Lens: 4"
- O.D. Base: 5"
- Depth: 1-7/8"
- Screw Size: #10 R.H.

SPARE PARTS ORDERING INFORMATION

Clear Bulbs (2 per card): 0337012DP Red Bulbs (2 per card): 0337R12DP
 Three Position Toggle Switch: 1263DP099A Socket: 0024DP1
 Lens: 0257DP4

DOME LIGHTS



Fig. 1258



Fig. 1258 - Round Surface Mount Dome Light
Fig. 1260 - Square Surface Mount Dome Light

CONSTRUCTION:

- Chrome Plated Zinc Alloy
- White Translucent Polymer Lens
- Push Switch with Water Resistant Boot
- 12 Volt, 10 Watt Bulb Included

4

ORDERING & TECH INFO

	Dimensions Inches	Depth Overall Inches	Maximum Wattage	Dealer Pkg. 5 Cards 1 Pc. per Card	OEM Bulk Pkg. 10 Pcs.	Screw Size	Ship Wt. Carton Lbs. DP/OEM Bulk
Round	3-3/4	1-1/4	10	1258DP2CHR	1258002CHR	8 R.H.	2.7/5.0
Square	3-5/8 x 4-1/4	1-1/4	10	1260DP2CHR	1260002CHR	8 R.H.	3.3/6.6

SPARE PARTS ORDERING INFORMATION

Bulbs (2 per card): 0070DPOCLR. Switch: 0701DP.
 Lens for 1258: 0244002WHT. Lens for 1260: 0245002WHT.
 NOTE: To Use These Lights in a 24 Volt System, Order Replacement Bulbs (2 per card): 0067DP1CLR.



Fig. 0555 - Surface Mount Dome Light

CONSTRUCTION:

- Chrome Plated Bronze
- For Systems Up To 50 Volts
- Available L.E.D. or with Twin Double Contact Bayonet Sockets
- Will Accommodate Incandescent Bulbs up to 20 Watts Each
- Toggle Switch, Incandescent Bulbs not Included

ORDERING & TECH INFO

O.D. Lens Inches	O.D. Base Inches	Depth Inches	Incandescent Std. Pkg. 1 Pc.	L.E.D. Std. Pkg. 1 Pc.	Screw Size	Ship Wt. Carton Lbs. Std. Pkg.
6	7-7/8	3-1/8	0555000CHR	0555L00CHR	8	4.5

SPARE PARTS ORDERING INFORMATION

Switch: 0514DP. Lens: 0257DP6. Socket: 0276000.
 Incandescent: Use Fig. 0337 Bulb, refer to Page 127 for Bulb Selection.



Fig. 0555



Fig. 0753 - Surface Mount Dome Light

CONSTRUCTION:

- Chrome Plated Wrought Brass
- Available L.E.D. or with Medium Screw Socket
- Incandescent Bulbs Not Included
- Toggle Switch
- For Systems Up To 50 Volts

Incandescent Size No. 1 Has One Socket and Switch. Will Accommodate One Bulb Up To 50 Watts
 Size No. 2 Has Two Sockets and Switches. Will Accommodate Two Bulbs Up To 25 Watts Each

ORDERING & TECH INFO

O.D. Glass Inches	O.D. Base Inches	Depth Inches	Incandescent Std. Pkg. 1 Pc.	L.E.D. Std. Pkg. 1 Pc.	Screw Size	Ship Wt. Carton Lbs. Standard Pkg.
8	9-1/2	4	0753001CHR	0753L01CHR	10 R.H.	2.9
8	9-1/2	4	0753002CHR	—	10 R.H.	3.1

SPARE PARTS ORDERING INFORMATION

Switch, Cat. No. 0514DP. Socket: 1323.
 Flat Lens For Newer 0753 Style (4" Depth): 0132FLTFRD.
 Curved Lens For Older 0753 Style (3" Depth): 0132CVDFRD.
 Incandescent: Use Fig. 0337 Bulb, refer to Page 127 for Bulb Selection.



Fig. 0753

Fig. 0372 - L.E.D. Rail or Surface Mount Deck Light



CONSTRUCTION:

- Brushed Marinium Alloy or White PERKO•KOTE Finish
- Low Draw, Long Life L.E.D. Lighting
- 12 Volt L.E.D.

4

Rail or Surface Mount
with Rotating Bracket



Fig. 0372

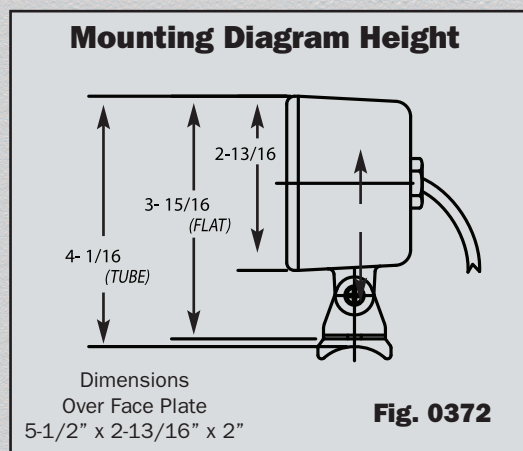

		ORDERING INFO		
Finish	Style	Dealer Pkg. 1 Pc. per Card	OEM Bulk Pkg. 1 Pc.	Ship Wt. Carton Lbs. DP/OEM Bulk
Plain Marinium	Flush Mt.	0372DPOMAR	0372000MAR	2.1/2.0
White Marinium	Flush Mt.	0372DPOWHT	0372000WHT	2.1/2.1

TECH INFO
<ul style="list-style-type: none"> • 12 Volt, 9W • L.E.D. Beam: 15° • Lab Rated L.E.D. Life: 50,000 Hrs. • Screw Size: #8
<p>Dimensions (LxWxD): 5-1/2" x 2-13/16" x 2"</p> <p>Ht. from Rail Mt.: 4-1/16" Ht. from Surface Mt.: 3-15/16" See Diagram</p>

SPREADER LIGHTS



4



Fig. 1040

Fig. 1040 - Adjustable Spreader Light
CONSTRUCTION:

- Molded Black Polymer Body
- Chrome Plated Brass Mounting Bracket
- Screw-in Lens Retaining Ring for Ease of Re-bulbing
- 12, 24 or 32 Volt Sealed Beam Unit Included

ORDERING INFO					TECH INFO
Voltage	Dealer Pkg. 1 Pc. per Card	Cards Per Pkg.	OEM Bulk Pkg. 10 Pcs.	Ship Wt. Carton Lbs. DP/OEM Bulk Pkg.	
12	1040DP112V	5	104000112V	8.1/13.5	12, 24 or 32 Volt O.D.: 4-1/2" Depth: 4-1/2" Dimensions Bracket: 4-1/2" x 1" Screw Size: #12 R.H.
24	1040DP224V	2	104000224V	3.4/13.5	
32	1040DP332V	2	104000332V	3.4/13.5	

SPARE PARTS ORDERING INFORMATION

Sealed Beam Unit (12 Volt): 043200112V.
Sealed Beam Unit (24 Volt): 043200224V.
Sealed Beam Unit (32 Volt): 043200332V.



Fig. 0280

Fig. 0280 - Adjustable Spreader Light
CONSTRUCTION:

- Chrome Plated Brass
- 12, 24 or 32 Volt Sealed Beam Unit Included

ORDERING INFO					TECH INFO
Voltage	Dealer Pkg. 1 Pc. per Card	Cards Per Pkg.	OEM Bulk Pkg. 10 Pcs.	Ship Wt. Carton Lbs. DP/OEM Bulk Pkg.	
12	0280DP112V	5	028000112V	6.5/10.1	12, 24 or 32 Volt O.D.: 4-5/8" Depth: 2-1/2" Dimensions Bracket: 5-3/8" x 3/4" Screw Size: #12 R.H.
24	0280DP224V	2	028000224V	2.7/10.1	
32	0280DP332V	2	028000332V	2.7/10.1	

SPARE PARTS ORDERING INFORMATION

Sealed Beam Unit (12 Volt): 043200112V.
Sealed Beam Unit (24 Volt): 043200224V.
Sealed Beam Unit (32 Volt): 043200332V.



**Fig. 0265
L.E.D.**



**Fig. 0265
Incandescent**

Fig. 0265 - Fixed Spreader Light

CONSTRUCTION:

- Chrome Plated Bronze
- 12 Volt, 10 Watt Bulb Included or 12 Volt, 4.5 Watt L.E.D. (No Serviceable Parts)
- L.E.D. Lab Rated Life: 50,000 Hours

ORDERING INFO					TECH INFO
Type	Dealer Pkg. 5 Pcs. 1 Pc. per Pkg.	OEM Bulk Pkg. 10 Pcs.	Ship Wt. Carton Lbs. DP/OEM Bulk Pkg.		
Incandescent	0265DPOCHR	0265000CHR	2.2/3.7	12 Volt O.D.: 2-3/4" Depth: 1-3/8" Screw Size: Incandescent #6 L.E.D. #4	
L.E.D.	0265DPLCHR*	0265L00CHR*	0.7/0.7		

SPARE PARTS ORDERING INFORMATION

Incandescent Bulbs (2 per card): 0070DPOCLR. Incandescent Socket Assembly: 026500099A.
Incandescent Lens with O-Ring: 0284DPOCLR.

* L.E.D. Std. Pkg. 1 Pc.

Fig. 0432 - Sealed Beam Unit

ORDERING & TECH INFO						
Nominal Voltage	Wattage	Amps	Standard Pkg. 1 Piece	Bulb Length Inches	Mfg. Lamp No.	Ship Wt. Carton Lbs. Standard Pkg.
12	35	3	043200112V	2-3/4	4406	0.5
24	50	2	043200224V	2-3/4	4593	0.5
32	60	2	043200332V	2-3/4	4350	0.5



Fig. 0432

4

Fig. 0337 - Double Contact Bayonet Base Bulb - Clear

ORDERING & TECH INFO							
Nominal Voltage	Wattage	Amps	Dealer Pkg. 5 Cards	Bulbs per Card	Bulb Diameter Inches	Mfg. Lamp No.	Ship Wt. Carton Lbs. Dealer Pkg.
12	7	.58	0337011DP	2	3/4	90	0.4
12	11	.94	0337012DP	2	3/4	1004	0.5
12	18	1.53	0337R12DP*	2	1	1142R	0.5
12	17	1.44	0337013DP	2	1	1142	0.5
24	15	.63	0337014DP	1	1	306	0.4
32	13	.40	0337018DP	1	3/4	624	0.3
32	14	.43	0337019DP	1	1	1228	0.4
32	21	.66	0337020DP	1	1	1692	0.4
32	24	.74	0337021DP	1	1-3/8	1054	0.5
120	15	-	0337023DP	2	7/8	15T7	0.5



Fig. 0337

* Red Bulb

Figs. 0067 & 0070 - Double Ended Festoon Bulbs
Clear with Nickel Plated Brass Caps

ORDERING & TECH INFO						
Nominal Voltage	Wattage	Amps	Dealer Pkg. 5 Cards 2 Bulbs per Card	Bulb Diameter Inches	Bulb Length Inches	Ship Wt. Carton Lbs. Dealer Pkg.
12	10	.74	0070DPOCLR	3/8	1-11/16	0.2
12	15	.97	0070DP1CLR	9/16	1-11/16	0.2
24	10	.42	0067DP1CLR	3/8	1-11/16	0.2

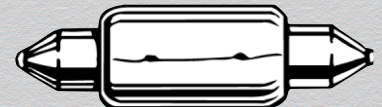

Fig. 0070

Fig. 0340 - Medium Screw Base Bulb

ORDERING & TECH INFO							
Nominal Voltage	Wattage	Amps	Standard Pkg. 6 Bulbs	Type	L.C.L. Inches	Mfg. Lamp No.	Ship Wt. Carton Lbs. Std. Pkg.
12	15	1.25	0340005FRD	A-17	2-3/8	15-A	0.6
12	25	2.08	0340006FRD	A-19	2-9/16	25-A	0.7
12	50	4.16	0340007FRD	A-21	3-7/16	50-A21	0.8
32	15	.47	0340011FRD	A-17	2-3/8	15-A	0.5
32	25	.78	0340012FRD*	A-19	2-9/16	25-A	0.4
32	50	1.56	0340013FRD*	A-21	3-7/16	50-A21	0.4



Fig. 0340

*Standard Pkg. - 2 Bulbs

Note: For High Power Bulbs and Sealed Beam Units for Searchlights, See Searchlight Section.
Electric Bulbs Are Not Returnable. Order Carefully.

Note: Bulbs Must Be Ordered in Standard or Dealer Package Quantities Only!

Bulbs for Navigation Lights See Pages 71 and 88

PERKO® U.S.C.G. ELECTRICAL STANDARDS

On January 31, 1977 the U.S.C.G. Published Safety Standards for Marine Electrical Systems. These Standards Cover Such Technical Details As:

4

- Batteries and Associated Conductors
- Conductor Size and Ampacity
- Strain Relief and Pull Tests
- Termination Requirements
- Overcurrent Protection
- Ignition Protection
- Grounding
- Insulation

A particular electrical component may be affected by some or all of the above categories. Those categories related to product design have been complied with, however, many additional details must be considered by the installer of the equipment as well in order to achieve compliance with this standard. It is suggested that the actual standard be familiarized when installing equipment. Perhaps one of the most critical requirements is ignition protection. A product that is marked "Ignition Protected" can be used in that area of a boat that is not isolated from a gasoline fuel vapor source. Refer to the actual standard for a determination of what parts of a boat require Ignition Protected products.

If a product is not plainly marked "Ignition Protected" then assume it is not.

For Details On All Of The Above, Obtain The Following:
U.S.C.G. Safety Standards For Electrical Systems
CFR Title 33, Chapter 1, Subchapter S, Part 183, Subpart I

COMPACT MEDIUM DUTY BATTERY SWITCHES

- Requires 1/3rd Less Space to Mount
- Higher Rating than Popular 8500 Series Switches
- New Smooth Rotary Action



- Popular 90° Easy to Identify Position Rotation
- On/Off & Selector Versions
- Locking & Non-Locking Models

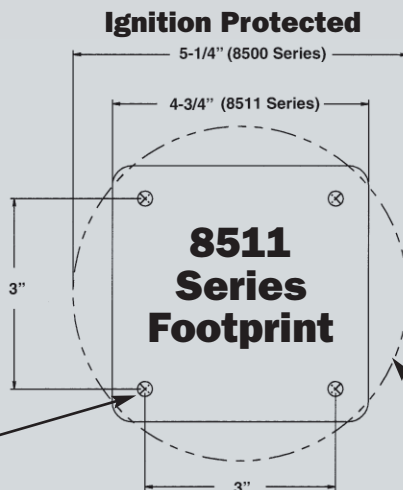

Same Mounting Hole Locations

8500 Series Footprint

See Page 129

COMPACT BATTERY SELECTOR & MAIN DISCONNECT SWITCHES

IGNITION PROTECTED

Protected by the following U.S. Patents; Design 260,637 - 4,280,028 - 4,424,424

For Use With 12, 24 and 32 Volt Marine Electrical Systems

Higher Capacity - 315 AMPS Continuous, 450 AMPS Intermittent

- Same Bolt Pattern as Popular 8500 Series
- Smooth, Positive Position Selector
- Four removable skirt panels for easy cable access and mounting



4

Fig. 8511 - Compact Battery Selector Switch

Fig. 8512 - Compact Battery Selector Switch with Key Lock

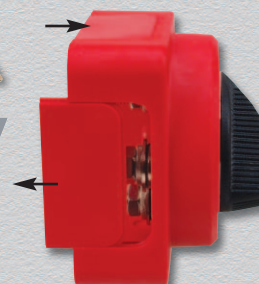

Fig. 8511

Fig. 8512

Illustration of removable skirt panels

ORDERING & TECH INFO

Features	Dealer Pkg. 5 Pcs. 1 Pc. per Pkg.	OEM Bulk Pkg. 25 Pcs.	Dimensions Inches	Depth Inches	Ship Wt. Carton Lbs. DP/OEM Bulk	Alternator Field Disconnect
w/o Key Lock	8511DP	8511	4-3/4 sq.	1-7/8	4.9/21.9	No
Key Lock	8512DP	8512	4-3/4 sq.	1-7/8	5.2/23.1	No

Surface Mount Trim Ring: 8511TRMRNG

IGNITION PROTECTED

Protected by the following U.S. Patents; Design 260,637 - 4,280,028 - 4,424,424

For Use With 12, 24 and 32 Volt Marine Electrical Systems

Higher Capacity - 315 AMPS Continuous, 450 AMPS Intermittent

- Same Bolt Pattern as Popular 9600 Series
- Smooth, Positive Position Selector
- Four removable skirt panels for easy cable access and mounting



Fig. 9611 - Compact Main Battery Disconnect Switch

Fig. 9612 - Compact Main Battery Disconnect Switch with Key Lock



Fig. 9611

Fig. 9612

Surface Mounting Trim Ring Available

ORDERING & TECH INFO

Features:	Dealer Pkg. 5 Pcs. 1 Pc. per Pkg.	OEM Bulk Pkg. 25 Pcs.	Dimensions Inches	Depth Inches	Ship Wt. Carton Lbs. DP/OEM Bulk	Alternator Field Disconnect
w/o Key Lock	9611DP	9611	4-3/4 sq.	1-7/8	4.6/20.0	No
Key Lock	9612DP	9612	4-3/4 sq.	1-7/8	4.8/21.5	No

Surface Mount Trim Ring: 8511TRMRNG

MEDIUM DUTY BATTERY SELECTOR SWITCHES



IGNITION PROTECTED

Protected by the following U.S. Patents; Design 260,637 - 4,280,028 - 4,424,424

For Use With 12, 24 and 32 Volt Marine Electrical Systems
Capacity - 250 AMPS Continuous, 360 AMPS Intermittent

Fig. 8501 - Medium Duty Battery Selector Switch

Fig. 8502 - Medium Duty Battery Selector Switch with Key Lock

Fig. 8503 - Medium Duty Battery Selector Switch with Alternator Field Disconnect

Fig. 8504 - Medium Duty Battery Selector Switch with Alternator Field Disconnect and Key Lock

When used with non-unitized alternators, these models will interrupt the field current (reducing the possibility of damage) if turned "OFF" with the engine running.



Fig. 8501



Fig. 8503



Fig. 8502



Fig. 8504

ORDERING & TECH INFO

Features	Dealer Pkg.	OEM	Diameter	Depth	Ship Wt.	Alternator
	5 Pcs.	Bulk Pkg.				
	1 Pc. per Pkg.	25 Pcs.	Inches	Inches	Carton Lbs.	Disconnect
w/o Key Lock	8501DP*	8501	5-1/4	2-5/8	5.0/21.5	No
with Key Lock	8502DP	8502	5-1/4	2-5/8	5.2/23.1	No
w/o Key Lock	8503DP	8503	5-1/4	2-5/8	5.0/21.5	Yes
with Key Lock	8504DP	8504	5-1/4	2-5/8	5.4/24.0	Yes

Description	Dealer Pkg.	OEM	Length	Width	Height	Ship Wt.
	5 Cards	Bulk Pkg.				
	1 Pc. per Card	25 Pcs.	Inches	Inches	Inches	Carton Lbs.
Spacer	0462DPORED	0462000RED	13-3/4	1/4	5/8	0.9/2.7

* 25 Pack Master Carton Available



Fig. 0462 Spacer For Large Cables

MEDIUM DUTY BATTERY DISCONNECT SWITCHES

IGNITION PROTECTED

Protected by the following U.S. Patents; Design 260,637 - 4,280,028 - 4,424,424

For Use With 12, 24 and 32 Volt Marine Electrical Systems
Capacity - 250 AMPS Continuous, 360 AMPS Intermittent



Fig. 9601 - Medium Duty Main Battery Disconnect Switch

Fig. 9602 - Medium Duty Main Battery Disconnect Switch with Key Lock

Fig. 9603 - Medium Duty Main Battery Disconnect Switch with Alternator Field Disconnect

Fig. 9604 - Medium Duty Main Battery Disconnect Switch with Alternator Field Disconnect and Key Lock

When used with non-unitized alternators, these models will interrupt the field current (reducing the possibility of damage) if turned "OFF" with the engine running.

Fig. 9601



Fig. 9603



Fig. 9602



Fig. 9604

ORDERING & TECH INFO

Features:	Dealer Pkg. 5 Pcs. 1 Pc. per Pkg.	OEM Bulk Pkg. 25 Pcs.	Diameter Inches	Depth Inches	Ship Wt. Carton Lbs. DP/OEM Bulk Pkg.	Alternator Field Disconnect
w/o Key lock	9601DP	9601	5-1/4	2-5/8	4.7/20.4	No
with Key lock	9602DP	9602	5-1/4	2-5/8	5.0/21.5	No
w/o Key lock	9603DP	9603	5-1/4	2-5/8	4.7/21.3	Yes
with Key lock	9604DP	9604	5-1/4	2-5/8	5.0/21.3	Yes

Description	Dealer Pkg. 5 Cards 1 Pc. per Card	OEM Bulk Pkg. 25 Pcs.	Length Inches	Width Inches	Height Inches	Ship Wt. Carton Lbs. DP/OEM Bulk
Spacer	0462DPORED	0462000RED	13-3/4	1/4	5/8	0.9/2.7



Fig. 0462 Spacer For Large Cables

HEAVY DUTY BATTERY SWITCHES



4

IGNITION PROTECTED

Protected by the following U.S. Patents; Design 260,637 - 4,280,028 - 4,424,424

Fig. 8603 - Heavy Duty Battery Selector Switch with Alternator Field Disconnect

For Use With 6, 12, 24 and 32 Volt Marine Electrical Systems
Capacity - Rated 380 AMPS Continuous,
850 AMPS Intermittent (5 Minutes On, 5 Minutes Off)



Fig. 8603

ORDERING & TECH INFO

Dealer Pkg. 2 Pcs. 1 Pc. per Pkg.	Dimension Inches	Depth Inches	Ship Wt. Carton Lbs. Dealer Pkg.	Alternator Field Disconnect
8603DP	5-1/4 sq.	3-3/8	5.0	Yes

IGNITION PROTECTED

Protected by the following U.S. Patents; Design 260,637 - 4,280,028 - 4,424,424

Fig. 9703 - Heavy Duty Battery Disconnect Switch with Alternator Field Disconnect

For Use With 6, 12, 24 and 32 Volt Marine Electrical Systems
Capacity - Rated 450 AMPS Continuous,
1200 AMPS Intermittent (15 Seconds On, 5 Minutes Off)



Fig. 9703

ORDERING & TECH INFO

Dealer Pkg. 2 Pcs. 1 Pc. per Pkg.	Dimension Inches	Depth Inches	Ship Wt. Carton Lbs. Dealer Pkg.	Alternator Field Disconnect
9703DP	5-1/4 sq.	3-3/8	5.0	Yes

BATTERY SWITCH TECHNICAL INFORMATION

Battery disconnect switches help manage the overall use of electrical power onboard. They are used to connect or disconnect electrical devices from the electrical system. They help to prevent battery drain during periods of inactivity. They allow for a quick and easy way to shut down the entire electrical system in an emergency. An optional key lock helps to prevent unauthorized use of the vessel.

In addition to doing everything a battery disconnect switch does, battery selector switches permit battery selection (of two or more batteries) for specific purposes including starting engines, running accessories or even recharging. They allow for the use of one or more batteries in systems with one or more engines and facilitate putting batteries in parallel for emergency starting when one or both batteries are substantially discharged.

All Perko Battery disconnect switches and battery selector switches are UL listed, ignition protected and CE approved. This means they have been tested and certified by a respected outside agency, are designed to be used safely in a bilge where explosive fumes may be present and meet all the requirements for use and sale throughout the world.

Perko battery switches are designed for surface mounting. Standard duty switches have a bright red polycarbonate housing for safety with a large easy-to-turn black knob. The housing of the heavy duty switches are red fiber-reinforced polycarbonate. Selector switches are designed with a "make before break" feature. This allows switching between the "1", the "all" and the "2" positions while the engine is running. Models with an "Alternator Field Disconnect" Feature offer protection for Non-Unitized Alternators should the switch accidentally be turned to the "OFF" position with the engine running.

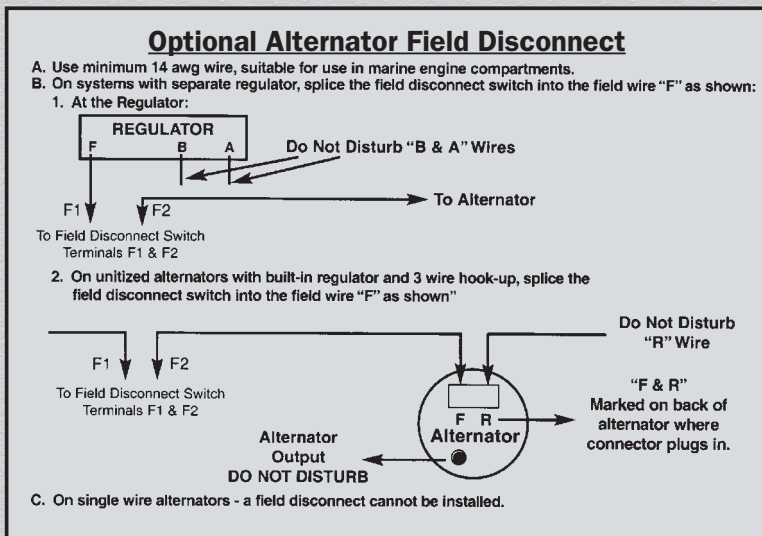
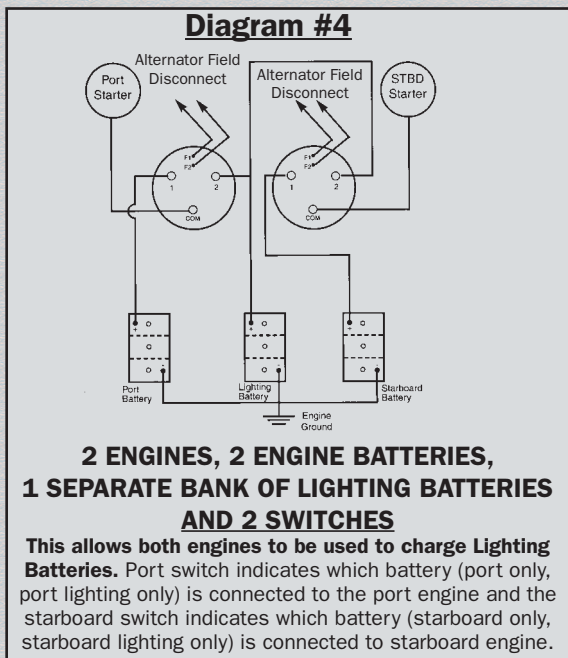
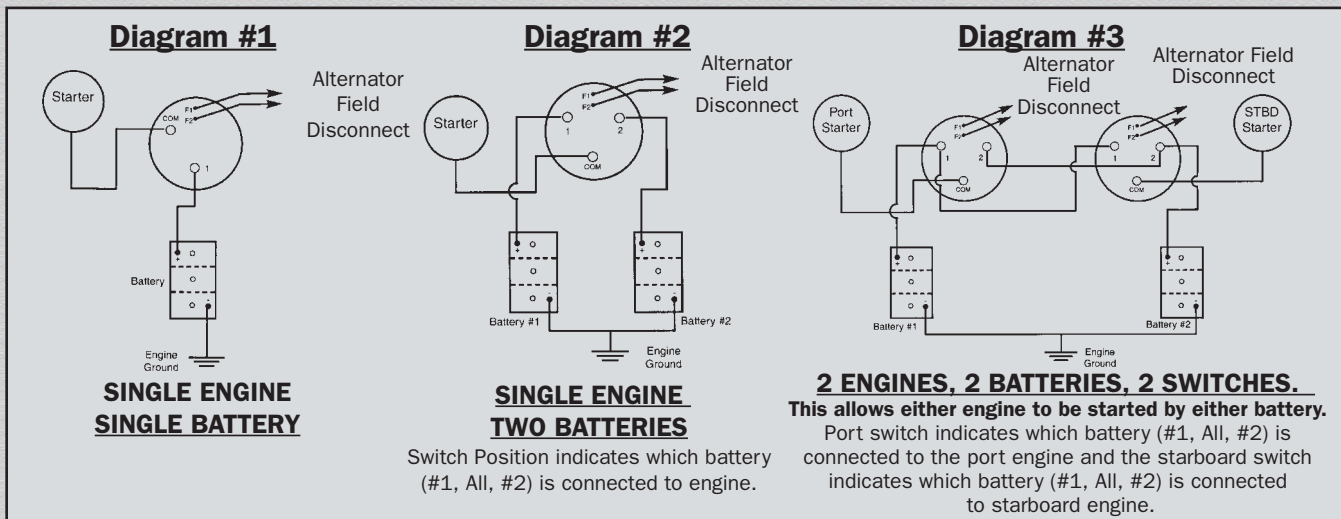

SWITCHES, IN-LINE FUSE HOLDER, DECK CONNECTION

Fig. 0701



Fig. 0701 - Push Button Switch

CONSTRUCTION:

- Black Polymer with Weather Resistant Cover
- Rated for 10 Amps at 12, 24 and 32 Volts
- Push-On, Push-Off

ORDERING & TECH INFO

Maximum Thickness of Panel Inches	Diameter Neck Inches	Dealer Pkg. 10 Cards 1 Pc. per Card	Ship Wt. Carton Lbs. Dealer Pkg.
1/8	3/8	0701DP	0.6

4



Fig. 0514



Fig. 0688

Figs. 0514/0688 - Toggle Switches

CONSTRUCTION:

- Nickel Plated Brass Toggle with Chrome Plated Face Nut
- Single Pole, Single Throw (Off-On)
- Fig. 0514 Rated for 6 Amps at 12, 24 and 32 Volts
- Fig. 0688 Rated for 20 Amps at 12, 24 and 32 Volts

ORDERING & TECH INFO

Max. Thickness of Panel Inches	Diameter Neck Inches	Dealer Pkg. 10 Cards 1 Pc. per Card	Ship Wt. Carton Lbs. Dealer Pkg.
5/16	7/16	0514DP	1.0
3/16	7/16	0688DPONKL	1.1

Important Note: None of the above Switches are Ignition Protected. See Page 128.

Fig. 0786 - In-Line Fuse Holder

CONSTRUCTION:

- Molded Polymer
- Rated for 20 Amps at 12, 24 and 32 Volts For 1/4" x 1-1/4" Fuses
- 12 Volt, 20 Amp Fuse and 7-1/2 Inch Wire Lead Included

ORDERING & TECH INFO

Length Inches	Diameter Inches	Dealer Pkg. 10 Cards 1 Pc. per Card	Ship Wt. Carton Lbs. Dealer Pkg.
2-1/8	11/16	0786DP	0.8

Fig. 0786

Figs. 1189 & 1190 - Watertight Deck Connections

CONSTRUCTION:

Fig. 1189 - Chrome Plated Brass
 Fig. 1190 - Chrome Plated Zinc Alloy

- Rated for 15 Amps at 12, 24 and 32 Volts Polarized Double Contact Connector
- Flange Gasket with Integral Waterproof Cap for Base When Plug is Removed

ORDERING & TECH INFO

Material	Diameter Inches	Height Inches	Dealer Pkg. 10 Cards 1 Pc. per Card	OEM Bulk Pkg. 50 Pcs.	Screw Size	Ship Wt. Carton Lbs. Bulk Pkg.
Chrome Brass	1-5/8	1-3/16	1189DPOCHR	1189000CHR	6	1.8/6.0
Chrome Zinc	1-5/8	1-3/16	1190DPOCHR	1190000CHR	6	1.9/7.0

Fig. 1189

Chrome Plated Brass

Fig. 1190

Chrome Plated Zinc

Note: These Items Are Not Ignition Protected.

SPARE PARTS ORDERING INFORMATION

Connector with Cover: 1189DP099A. Connector Only: 0042.

Important Note: All of the Above Items Conform to U.S.C.G. Electrical Standards. See Page 128.

CABLE OUTLET, CABLE STRAPS & LINE SUPPORT CLIPS

Figs. 0424 & 1191 - Watertight Cable Outlets

CONSTRUCTION:

Fig. 0424, Chrome Plated Brass

Fig. 1191, Chrome Plated Zinc Alloy

- For 5/16 Inch O.D. Cable
- Equipped with Rubber Grommet for Watertight Passage of Cable

ORDERING & TECH INFO

Material	Diameter Base Inches	Dealer Pkg. 10 Cards 1 Pc. per Card	Screw Size	Ship Wt. Carton Lbs. Dealer Pkg.
Chrome Brass	1-1/4	0424DPOCHR	6	1.1
Chrome Zinc	1-1/4	1191DPOCHR	6	1.1



Fig. 0424
Chrome Plated Brass
Fig. 1191
Chrome Plated Zinc

4

Fig. 0196 - Polymer Cable Strap

CONSTRUCTION:

- Black Polymer
- Ultra-Violet Stabilized for Weather Resistance
- Eliminates the Need for Insulating Cushion

ORDERING & TECH INFO

I.D. Inches	Dealer Pkg. 10 Cards 10 Pcs. per Card	OEM Bulk Pkg. 500 Pcs.	Ship Wt. Carton Lbs. DP/OEM Bulk Pkg.
3/16	0196DP1	0196001	0.6/1.1
1/4	0196DP2	0196002	0.6/1.2
5/16	0196DP3	0196003	0.7/1.3
3/8	0196DP4	0196004	0.7/1.4
1/2	0196DP5	0196005	0.9/1.7
5/8	0196DP6	0196006	1.0/2.1
3/4	0196DP7	0196007	1.0/2.5



Fig. 0196

Width all sizes - 1/2 inch

Note: This Item Conforms to U.S.C.G. Electrical Standards. See page 128.

Figs. 0163, 0164, 0165 - Line Support Clips

CONSTRUCTION:

- Aluminum with Synthetic Rubber Cushion



Fig. 0163
Single



Fig. 0164
Double



Fig. 0165
Triple

ORDERING & TECH INFO

For O.D. Line Inches	Width Inches	Single Dealer Pkg. - 10 Cds. 10 Pcs. per Card	Double Dealer Pkg. - 10 Cds. 10 Pcs. per Card	Triple Dealer Pkg. - 10 Cds. 10 Pcs. per Card	Ship Wt. Carton Lbs. 0163/0164/0165
3/16	3/8	0163DP1ALU	0164DP1ALU	_____	0.9/1.1/-
1/4	3/8	0163DP2ALU	0164DP2ALU	_____	1.0/1.3/-
5/16	1/2	0163DP3ALU*	0164DP3ALU	0165DP3ALU	1.1/1.4/1.8
3/8	1/2	0163DP4ALU*	0164DP4ALU	0165DP4ALU	1.6/1.9/2.6
1/2	1/2	0163DP5ALU	0164DP5ALU*	0165DP5ALU*	2.0/2.5/3.1
5/8	1/2	0163DP6ALU*	_____	_____	2.6/-/-

*OEM Package - 500 Pcs. Replace "DP" with "00" When Ordering

Note: This Item Conforms to U.S.C.G. Electric & Fuel Standards

Fig. 0707 - Ventilator

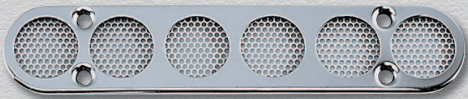

Fig. 0707

CONSTRUCTION:

- Chrome Plated Brass Frame & Screen

ORDERING INFO			TECH INFO
Dealer Pkg. 10 Cards 1 Pc. per Card 0707DPOCHR	OEM Bulk Pkg. 25 Pcs. 0707000CHR	Ship Wt. Carton Lbs. DP/OEM Bulk 1.8/3.4	Dimensions: 7-1/4" x 1-1/2" Screw Size: #8

Fig. 0330 - Locker Ventilator



Fig. 0330

CONSTRUCTION:

- Chrome Plated Brass or Stainless Steel

ORDERING INFO				TECH INFO
Finish	Dealer Pkg. 10 Cards 1 Pc. per Card	OEM Bulk Pkg. 100 Pcs.	Ship Wt. Carton Lbs. DP/OEM Bulk	O.D. Size 1: 2-1/2" O.D. Size 2: 3-1/4" Screw Size: #6 R.H.
Chrome	0330DP1CHR	0330001CHR	0.9/4.2	
Chrome	0330DP2CHR	0330002CHR	1.6/7.1	
Stainless	0330DP1STS	0330001STS	0.9/4.2	
Stainless	0330DP2STS	0330002STS	1.5/6.7	

Fig. 0550 - Transom or Locker Ventilator

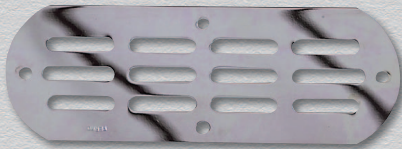

Fig. 0550

CONSTRUCTION:

- Chrome Plated Brass or Stainless Steel

ORDERING INFO				TECH INFO
Finish	Dealer Pkg. 10 Cards 1 Pc. per Card	OEM Bulk Pkg. 25 Pcs.	Ship Wt. Carton Lbs. DP/OEM Bulk	Dimensions: 7-1/4" x 1-1/2" Screw Size: #8
Chrome	0550DPOCHR	0550000CHR	2.3/3.9	
Stainless	0550DPOSTS	0550000STS	2.3/3.9	

Fig. 1271 - Transom or Locker Ventilator



Fig. 1271

CONSTRUCTION:

- Chrome Plated Zinc Alloy
- Anodized Aluminum Expanded Mesh Screen

ORDERING INFO				TECH INFO
Dealer Pkg. 10 Cards 1 Pc. per Card 1271DPOCHR	OEM Bulk Pkg. 25 Pcs. 1271000CHR	Ship Wt. Carton Lbs. DP/OEM Bulk 2.4/4.6	Dimensions: 6" x 2" Screw Size: #8	

Fig. 1238 - Transom or Locker Ventilator



Fig. 1238

CONSTRUCTION:

- Chrome Plated Zinc Alloy
- Anodized Aluminum Grill-Type Screen

ORDERING INFO			TECH INFO
Dealer Pkg. 10 Cards 1 Pc. per Card 1238DPOCHR	OEM Bulk Pkg. 50 Pcs. 1238000CHR	Ship Wt. Carton Lbs. DP/OEM Bulk 3.7/13.0	Dimensions: 8-3/8" x 2-1/4" Screw Size: #8

Fig. 0334 - Louver Ventilator

CONSTRUCTION:

- Chrome Plated Brass or Stainless Steel

ORDERING & TECH INFO

Finish	Dimensions Inches	Length Louvers Inches	Dealer Pkg.		OEM Bulk Pkg. 10 Pcs.	Ship Wt. Carton Lbs. DP/OEM Bulk
			5 Cards 1 Pc. per Card			
Chrome Brass	3 x 2-1/2	2	0334002DP	0334002CHR	0.5/0.8	
Chrome Brass	4 x 2-1/2	3	033402ADP	033402ACHR	0.7/1.1	
Chrome Brass	5-1/2 x 2-1/2	2	0334004DP	0334004CHR	0.9/1.4	
Chrome Brass	7-1/2 x 2-1/2	3	033404ADP	033404ACHR	1.3/2.1	
Chrome Brass	8 x 2-1/2	2	0334006DP	0334006CHR	1.4/2.3	
Chrome Brass	11 x 2-1/2	3	033406ADP	033406ACHR	2.0/3.2	
Stainless Steel	3 x 2-1/2	2	0334002DPS	0334002STS	0.5/0.9	
Stainless Steel	4 x 2-1/2	3	033402ADPS	033402ASTS	0.7/1.1	
Stainless Steel	5-1/2 x 2-1/2	2	0334004DPS	0334004STS	0.9/1.4	
Stainless Steel	7-1/2 x 2-1/2	3	033404ADPS	033404ASTS	1.3/2.1	
Stainless Steel	8 x 2-1/2	2	0334006DPS	0334006STS	1.4/2.3	
Stainless Steel	11 x 2-1/2	3	033406ADPS	033406ASTS	2.0/3.2	



#2

#4



#6

Fig. 0334

Screw Size #4 R.H.

Fig. 0335 - Louver Ventilator

CONSTRUCTION:

- Chrome Plated Brass or Stainless Steel

ORDERING & TECH INFO

Finish	Dimensions Inches	Length Louvers Inches	Dealer Pkg.		OEM Bulk Pkg. 10 Pcs.	Ship Wt. Carton Lbs. DP/OEM Bulk
			5 Cards 1 Pc. per Card			
Chrome Brass	3 x 3	2	0335003DP	0335003CHR	0.7/1.0	
Chrome Brass	4 x 3-1/2	3	033503ADP	033503ACHR	1.1/1.8	
Chrome Brass	5-1/2 x 3	2	0335006DP	0335006CHR	1.2/1.8	
Chrome Brass	7-1/2 x 3-1/2	3	033506ADP	033506ACHR	1.8/3.0	
Chrome Brass	8 x 3	2	0335009DP	0335009CHR	1.7/2.7	
Chrome Brass	11 x 3-1/2	3	033509ADP	033509ACHR	2.6/4.3	
Stainless Steel	3 x 3	2	0335003DPS	0335003STS	0.7/1.0	
Stainless Steel	4 x 3-1/2	3	033503ADPS	033503ASTS	1.1/1.8	
Stainless Steel	5-1/2 x 3	2	0335006DPS	0335006STS	1.2/1.8	
Stainless Steel	7-1/2 x 3-1/2	3	033506ADPS	033506ASTS	1.8/3.0	
Stainless Steel	8 x 3	2	0335009DPS	0335009STS	1.7/2.7	
Stainless Steel	11 x 3-1/2	3	033509ADPS	033509ASTS	2.6/4.3	



#3

#6



#9

Fig. 0335

Screw Size #4 R.H.

Fig. 0336 - Louver Ventilator

CONSTRUCTION:

- Chrome Plated Brass or Stainless Steel

ORDERING & TECH INFO

Finish	Dimensions Inches	Length Louvers Inches	Dealer Pkg.		OEM Bulk Pkg. 10 Pcs.	Ship Wt. Carton Lbs. DP/OEM Bulk
			5 Cards 1 Pc. per Card			
Chrome Brass	3 x 3-3/4	2	0336004DP	0336004CHR	0.9/1.3	
Chrome Brass	4 x 4-3/8	3	033604ADP	033604ACHR	1.3/2.0	
Chrome Brass	3 x 4-1/2	2	0336005DP	0336005CHR	1.0/1.0	
Chrome Brass	4 x 5-3/8	3	033605ADP	033605ACHR	1.5/2.4	
Chrome Brass	3 x 5-1/4	2	0336006DP	0336006CHR	1.2/1.5	
Chrome Brass	4 x 6-3/8	3	033606ADP	033606ACHR	1.8/2.9	
Stainless Steel	3 x 3-3/4	2	0336004DPS	0336004STS	0.9/1.3	
Stainless Steel	4 x 4-3/8	3	033604ADPS	033604ASTS	1.3/2.0	
Stainless Steel	3 x 4-1/2	2	0336005DPS	0336005STS	1.0/1.0	
Stainless Steel	4 x 5-3/8	3	033605ADPS	033605ASTS	1.5/2.4	
Stainless Steel	3 x 5-1/4	2	0336006DPS	0336006STS	1.2/1.5	
Stainless Steel	4 x 6-3/8	3	033606ADPS	033606ASTS	1.8/2.9	



#4

#5

#6

Fig. 0336

Screw Size #4 R.H.

COWL & CLAM SHELL VENTILATORS



Fig. 1312

- Fig. 1312 - Cowl Ventilator**
- Chrome Plated Zinc Alloy Cowl with Black Polymer Base
 - 3" Duct Threads into Neck, Hose Clamps Not Required

ORDERING INFO				TECH INFO
Cowl Opening Square Inches	Dealer Pkg. 5 Cards 1 Pc. per Card	OEM Bulk Pkg. 50 Pcs.	Ship Wt. Carton Lbs. DP/OEM Bulk	Length: 5-3/4" Width: 4-3/8" Height: 2-5/8" Screw Size: #8
8	1312DP0CHR	1312000CHR	5.2/42.5	



Fig. 0870

- Fig. 0870 - Cowl Ventilator**
- Chrome Plated Zinc Alloy Cowl with Black PERKO•KOTE Base
 - 3" Duct Threads into Neck, Hose Clamps Not Required

ORDERING INFO				TECH INFO
Cowl Opening Square Inches	Dealer Pkg. 1 Pc.	OEM Bulk Pkg. 5 Pcs.	Ship Wt. Carton Lbs. DP/OEM Bulk	Length: 5-1/8" Width: 4" Height: 3-7/8" Screw Size: #10
7-1/3	0870DP0CHR	0870000CHR	1.4/7.0	



Fig. 0510

- Fig. 0510 - Cowl Ventilator**
- Polished or Chrome Plated Brass, Cast Bronze Deck Plate
 - Internal Thumb Screw Allows Cowl to be Locked in any Position
 - Ventilators are Painted White Inside Only

ORDERING INFO			TECH INFO
Polished Brass Standard Pkg. - 1 Pc.	Chrome Plated Brass Standard Pkg. - 1 Pc.	Ship Wt. Carton Lbs. POL/CHR	I.D. Deck Plate: 4" O.D. Deck Plate: 7-1/16" Dia. Cowl: 8" Width Opening: 8" Height Opening: 11" Screw Size: #10
0510004POL	0510004CHR	6.5/6.2	

For Spare Deck Plates, Covers and Keys; Refer to Fig. No. 0526, Pg 183.

Fig. 0315 - Clam Shell Ventilator

- Chrome Plated Brass or Stainless Steel



Fig. 0315

ORDERING & TECH INFO						
Dimensions Base Inches	Height Opening Inches	Width Opening Inches	Dealer Pkg. 10 Cards 1 Pc. per Card	OEM Bulk Pkg. 100 Pcs.	Screw Size	Ship Wt. Carton Lbs. DP/OEM Bulk
Chrome Brass						
1-5/8 x 1-1/2	7/16	7/8	0315DP1CHR	0315001CHR	4	0.8/3.3
2 x 2	9/16	1-1/8	0315DP2CHR	0315002CHR	6	1.3/8.3
Stainless Steel						
1-5/8 x 1-1/2	7/16	7/8	0315DP1STS	0315001STS	4	0.8/2.6
2 x 2	9/16	1-1/8	0315DP2STS	0315002STS	6	1.1/2.7

Fig. 0339 - Clam Shell Ventilator

- Chrome Plated Brass

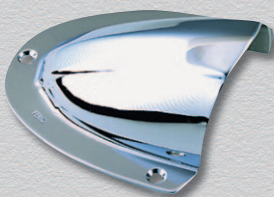

Fig. 0339

ORDERING INFO			TECH INFO
Dealer Pkg. 5 Cards 1 Pc. per Card	OEM Bulk Pkg. 25 Pcs.	Ship Wt. Carton Lbs. DP/OEM Bulk	Dimensions Base: 4" x 3-3/4" Width Opening: 2-1/2" Height Opening: 1-5/8" Screw Size: #6
0339DP0CHR	0339000CHR	2.2/8.5	

FOG HORN, WHISTLE, PORTLIGHT CHAIN AND WEATHERSTRIPPING

Note: Figs. 0162 & 0349 Conform to A.B.Y.C. Standard A-23 in Accordance with the '72 COLREGS and U.S. Inland Rules for Use on Vessels Under 5 Meters (16.4 ft.) in Length.

Fig. 0162 - Fog Horn

CONSTRUCTION:

- Aluminum with White Baked Enamel Finish
- Nylon Mouthpiece



Fig. 0162

ORDERING & TECH INFO

Length Inches	Dealer Pkg. - 10 Bags 1 Pc. per Bag	Ship Wt. Carton Lbs. Dealer Pkg.
12-1/2	0162DPOWHT	1.6

Fig. 0349 - "Ball Type" Whistle

CONSTRUCTION:

- Orange Polymer



Fig. 0349

ORDERING INFO

TECH INFO

Dealer Pkg. - 10 Cds. 1 Pc. per Card	OEM Bulk Pkg. 100 Pcs.	Ship Wt. Carton Lbs. DP/OEM Bulk Pkg.
0349DP	0349	0.9/3.4

Length: 2-1/4"
Width: 3/4"

Fig. 0441 - Portlight Chain

CONSTRUCTION:

- Stainless Steel Chain with Chrome Plated Fittings



Fig. 0441

ORDERING INFO

TECH INFO

Dealer Pkg. 10 Cds. 1 Pc. per Card	OEM Bulk Pkg. 50 Pcs.	Ship Wt. Carton Lbs. DP/OEM Bulk Pkg.
0441DPOCHR	0441000CHR	0.7/3.9

Length: 7"
Length Strap: 1-7/8"
Screw Size: #8

Fig. 0461 - Portlight Weatherstripping

CONSTRUCTION:

- Open Cell Foam Rubber
- Supplied in Ten Foot Lengths

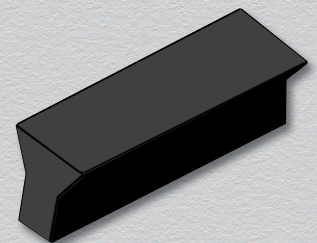

Fig. 0461

ORDERING INFO

TECH INFO

Standard Pkg. 10 ft. Length	Ship Wt. Carton Lbs. Standard Pkg.
0461	0.4

Max Width: 7/16"
Min. Width: 1/4"
Height: 3/8"



The 8 and 12 Inch Bells Listed on This Page Have Been Reviewed by the U.S. Coast Guard and Comply with C.G. 169 Regulations for Sound Signal Appliances as Required by Annex III Paragraph 2 of the '72 Colregs. The 8 Inch Size is for Use on Vessels Under 20 Meters (65.6 ft.) in Length. The 12 Inch Size is for Use on Vessels of any Length.

5

Fig. 0420 Polished



Fig. 0420 - Fog Bell

CONSTRUCTION:

- Cast Bronze
- Chrome Plated or Polished
- Medium Weight
- Removable

ORDERING & TECH INFO

Bottom Diameter Inches	Height Overall Inches	Polished Bronze Std. Pkg. - 1 Pc.	Chrome Plated Bronze Std. Pkg. - 1 Pc.	Ship Wt. Carton Lbs.
6	5	0420006POL	0420006CHR	3.8
8	6-1/8	0420008POL	0420008CHR	8.7

Screw Size #8 F.H.

Fig. 0420 Chrome



Fig. 0150 - Fog Bell

CONSTRUCTION:

- Cast Bronze
- Chrome Plated, Plain or Polished
- Heavy Weight
- Removable

ORDERING & TECH INFO

Bottom Diameter Inches	Height Overall Inches	Plain Bronze Std. Pkg. 1 Pc.	Polished Bronze Std. Pkg. 1 Pc.	Chrome Plated Bronze Std. Pkg. 1 Pc.	Ship Wt. Carton Lbs.
8	8	0150008PLB	0150008POL	0150008CHR	9.5
12	12	0150012PLB	0150012POL	0150012CHR	36.0

Screw Size 1/4" F.H.



Fig. 0150 Chrome

SPARE PARTS ORDERING INFORMATION

For complete Spare Part No. Insert Finish Code: P or PLB, for Plain Bronze or Brass Finish (i.e. 0420P0699A or 0127000PLB). B or POL, for Polished Bronze or Brass Finish (i.e. 0420B0699A or 0127000POL). C or CHR, for Chrome Plated Finish (i.e. 0420C0699A or 0127000CHR).

Figure No.	ARMS	WALL PLATES	CLAPPERS	EYE BOLTS	ACORN NUTS
	Spare Part No.	Spare Part No.	Spare Part No.	Spare Part No.	Spare Part No.
0420-6"	0420_0699A	0127000_ _ _	0153008CHR	0113000CHR	0465004_ _ _
0420-8"	0171000_ _ _	0127000_ _ _	0144000_ _ _	0123000PLB	0465008_ _ _
0150-8"	0171000_ _ _	0127000_ _ _	0144000_ _ _	123000PLB	0465008_ _ _
0150-12"	0150_1299A	0150_1299B	0172000_ _ _*	0172000_ _ _*	0465009_ _ _
0158-12	0158_ _ _99A*	0158_0099A*	0172000_ _ _*	0172000_ _ _*	0465009_ _ _
0179	017900099A*	017900099A*	0144000_ _ _	017900099B	0465008_ _ _
0159-6"	0159_0099A	0166000_ _ _	0159C0699B	0113000CHR	0465004_ _ _
0159-8"	0159_0099A	0166000_ _ _	0153008_ _ _	0113000CHR	0465004_ _ _
	*Includes Wall Bracket	*Includes Arm	*Includes Eye Bolt	*Includes Clapper	

The 8 and 12 Inch Bells Listed on This Page Have Been Reviewed by the U.S. Coast Guard and Comply with C.G. 169 Regulations for Sound Signal Appliances as Required by Annex III Paragraph 2 of the '72 Colregs. The 8 Inch Size is for Use on Vessels Under 20 Meters (65.6 ft.) in Length. The 12 Inch Size is for Use on Vessels of any Length.

Fig. 0158 - Fog Bell

CONSTRUCTION:

- Cast Bronze
- Chrome Plated, Plain or Polished
- Heavy Weight
- Fixed Mounting



5

Fig. 0158 Polished

ORDERING & TECH INFO

Bottom Diameter Inches	Height Overall Inches	Plain Bronze		Polished Bronze		Chrome Plated Bronze		Ship Wt. Carton Lbs.
		Std.	Pkg. 1 Pc.	Std.	Pkg. 1 Pc.	Std.	Pkg. 1 Pc.	
12	12	0158012PLB		0158012POL		0158012CHR		37.0

Screw Size 1/4" R.H.

Fig. 0179 - Fog Bell

CONSTRUCTION:

- Wrought Brass
- Plain Brass Finish
- Light Weight
- Fixed Mounting



Fig. 0179

ORDERING & TECH INFO

Bottom Diameter Inches	Height Overall Inches	Standard Pkg. 1 Pc.	Ship Wt. Carton Lbs. Std. Pkg.
12	8	0179012PLB	7.3

Screw Size #12 R.H.

Fig. 0159 - Fog Bell

CONSTRUCTION:

- Stamped Brass
- Plain or Chrome Plated
- Light Weight
- Removable



Fig. 0159 Chrome

ORDERING & TECH INFO

Bottom Diameter Inches	Height Overall Inches	Dealer Pkg. - 2 Pcs. 1 Pc. per Pkg.		Ship Wt. Carton Lbs.
		Chrome Plated	Plain Brass	
6	4	0159DP6CHR	0159DP6PLB	3.4
8	5	0159DP8CHR*	0159DP8PLB*	6.0



Fig. 0159 Plain

Screw Size #4 F.H.

* 2 pc. bulk package available, Chrome Plated or Plain Brass

DUPLEX INTAKE WATER STRAINER

NEW Item

Available by
Oct. 2010

Figs. 0594 - Duplex Intake Water Strainer

Duplex strainers permit continuous engine operation by permitting strainer clean-out while the engine is running. Properly sized, a single side of the strainer will allow adequate flow for cooling. Using an integral valve, either side can be closed and cleaned without affecting coolant flow to the engine through the other side.

CONSTRUCTION:

- Cast Bronze
- 4-Position Control Valve (All Off/Side 1 On/Side 2 On/Both On)
- Many Replacement Parts in Common with Other Perko Strainers (Fig. 0493)

PERKO Duplex Water Strainers are Designed for Easy Installation and Cleaning. Features Include Mounting Lugs Cast into Both Sides to Assure Universal Mounting, 8 Outside Tie Rods and two 316 Stainless Steel Strainer Basket to Minimize Electrolysis. The diameter of the screen holes is 0.079" providing 47% open area, among the highest in the industry for cylindrical strainer baskets. Lugs for the Cast Bronze Covers Permit Easy Removal and Cleaning of the Strainer Baskets. Drain Plugs in the Bottom Castings are Provided for Easily Removing Sediment and Draining for Winterizing.

6



Fig. 0594

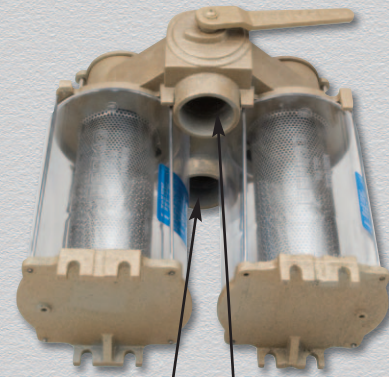

Pipe Connections

ORDERING & TECH INFO

Pipe Size Inches	Standard Pkg. - 1 Pc.	Height Overall Inches	Width Overall Inches	Depth Overall Inches	Dimensions Cylinder Inches O.D. x L	Open Area Dimensions Basket Inches	Each Side Open Area Ratio	Ship Wt. Carton Lbs. Std. Pkg.	Spare Gasket Kit* Dealer Pkg. - 5 Kts. 1 Kit. per Bag
1-1/2	0594008PLB	12	16	8-1/2	6 x 8	3-5/16 8-7/16	17:1	61	0594DP899R
2	0594009PLB	16	16	8-1/2	6 x 12	3-5/16 x 12-1/4	13:1	63	0594DP899R
2-1/2	0594010PLB	16	16	8-1/2	6 x 12	3-5/16 x 12-1/4	10:1	63	0594DP899R

DUPLEX INTAKE WATER STRAINER SPARE PARTS ORDERING INFORMATION

For Spare Part No. Insert a Spare Part Code Listed Below in Place of the "PLB" in the Strainer's Catalog Number (i.e., 059400699A, Top Casting for 1-1/2" (#8) Strainer).

Description	Spare Part Code	Sample Part Number	Package	Description	Code	Sample Part Number	Package
Top Casting	.99A	059400899A	Boxed	Wing Nuts & Bolts for Cover	.99L	0493DP899L	Bag
Transparent Cylinder	.99C	049300899C	Boxed	Rubber Gasket Kit			
Basket Strainer Size 8	.99D	059400899D	Boxed	Consists of:			
Basket Strainer Sizes 9 & 10	.99D	049300999D	Boxed	2 Cover Gaskets & 4 Body Gaskets			99R* 0594DP899R Bag
Cover with Gasket	.99E	0049300899E	Boxed	Tie Rods			
				Consists of (4 Each for)			.99P 0493DP899P Bag

LIGHTWEIGHT INTAKE WATER STRAINER WITH CLEAR BODY

NEW Item

Available by
Oct. 2010

Fig. 0443 - Lightweight Intake Water Strainer

CONSTRUCTION:

- Cast Bronze with Clear Polymer Body
- Our Lightest Weight Strainer
- Many Replacement Parts in Common with Other Perko Strainers (Fig. 0493)

PERKO Water Strainers are Designed for Easy Installation and Cleaning. Features Include Mounting Lugs Cast into Both Sides to Assure Universal Mounting and a 316 Stainless Steel Strainer Basket to Minimize Electrolysis. The diameter of the screen holes is 0.079" providing 47% open area, among the highest in the industry for cylindrical strainer baskets. Hinged Lugs for the Cast Bronze Cover Permit Easy Removal and Cleaning of the Strainer Basket. A Drain Plug in the Bottom Casting is Provided for Easily Removing Sediment and Draining for Winterizing.



Fig. 0443

FIG. 0443 - DIFFERENTIAL PRESSURE GRAPH

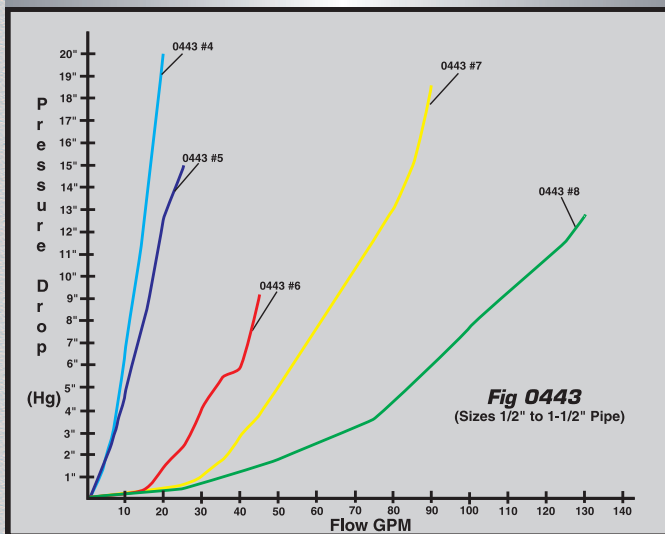

ORDERING & TECH INFO

Pipe Size Inches	Standard Pkg. - 1 Pc.	Height Overall Inches	Width Overall Inches	Dimensions Cylinder Inches O.D. x L	Dimensions Basket Inches	Open Area To Pipe Size Ratio	Ship Wt. Carton Lbs. Std. Pkg.	Spare Gasket Kit* Dealer Pkg. - 5 Kts. 1 Kit. per Bag
1/2	0443004PLB	6-1/4	4-1/2	3-1/2 x 4-1/4	1-13/16 x 4-3/8	30:1	3.9	0443DP599R
3/4	0443005PLB	8-5/8	4-1/2	3-1/2 x 6-5/8	1-13/16 x 6-1/4	25:1	4.0	0443DP599R
1	0443006PLB	8-3/4	5-1/2	4-1/2 x 6	2-5/8 x 5-7/8	20:1	6.7	0443DP799R
1-1/4	0443007PLB	9-5/16	5-1/2	4-1/2 x 6-9/16	2-5/8 x 6-1/4	13:1	6.5	0443DP799R
1-1/2	0443008PLB	11-3/4	7-1/4	6 x 8-5/8	3-5/16 x 8-7/16	17:1	11.1	0443DP999R

CLEAR BODY INTAKE WATER STRAINER SPARE PARTS ORDERING INFORMATION

For Spare Part No. Insert a Spare Part Code Listed Below in Place of the "PLB" in the Strainer's Catalog Number (i.e., 049300699A, Top Casting for 1" (#6) Strainer).

Description	Spare Part Code	Sample Part Number	Package	Description	Spare Part Code	Sample Part Number	Package
Top Casting	.99A	049300499A	Boxed	Hinged Bolt for Cover			
Transparent Cylinder Body	.99C	044300499C	Boxed	With Pin, Nut and Washer	.99L	0493DP599L	Bag
Basket Strainer	.99D	049300499D	Boxed	Rubber Gasket Kit Consists of:			
Cover with Gasket	.99E	049300499E	Boxed	1 Cover Gasket & 1 Body Gasket	.99R*	0443DP599R	Bag
				Nuts and Washers Consists of:			
				4 Each for 0443 Series	.99F	0443DP499F	Bag

HEAVY DUTY 4" INTAKE WATER STRAINER



Fig. 0693 - Intake Water Strainer

CONSTRUCTION:

- Cast Bronze

The new Perko Large Boat Strainer Line is designed for easy installation, cleaning and maintenance. Aircraft style mounting nuts hold fast without lock washers. They are held captive by the body and can't be dropped or lost. Once the mounting nuts are loosened, a convenient handle on the top cover allows it to be easily rotated and removed providing quick access to the strainer basket. Four 316 stainless steel tie rods and strainer basket minimize electrolysis. The diameter of the screen holes is 0.079" providing 47% open area, among the highest in the industry for cylindrical strainer baskets. A drain plug in the bottom casting is provided for easy sediment removal or to drain when winterizing. A transparent cylinder provides a visual check for debris.

6

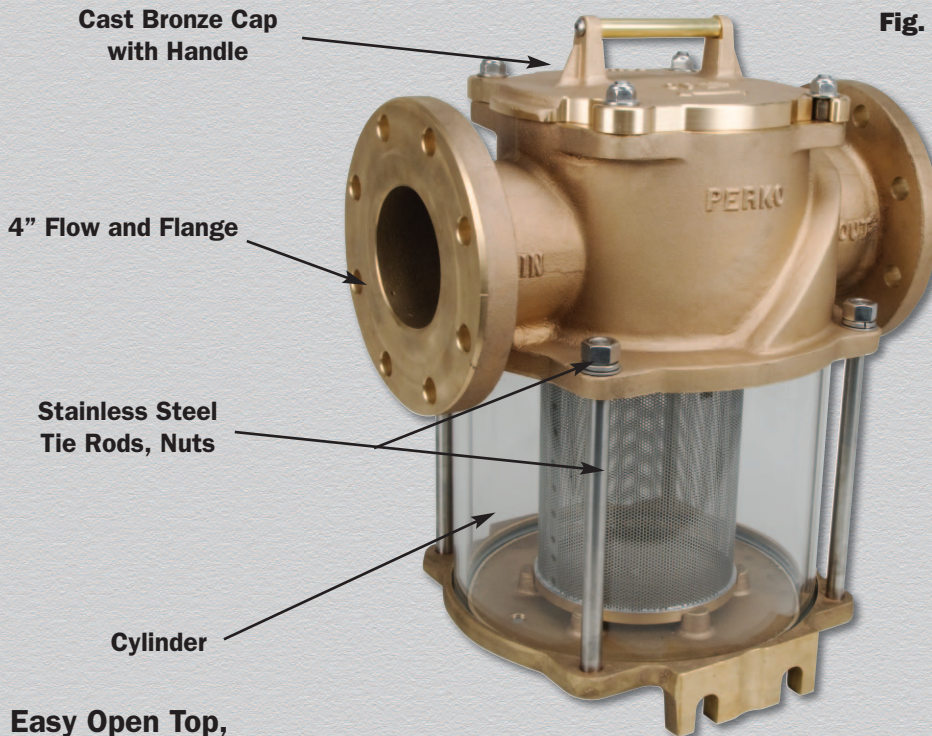

Fig. 0693



Basket

**Easy Open Top,
Simply Loosen 4 Captive Nuts**

Twist and Lift

Flow Chart

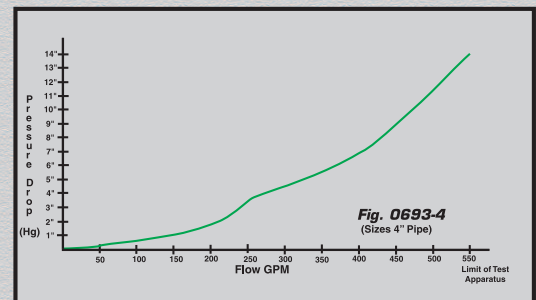
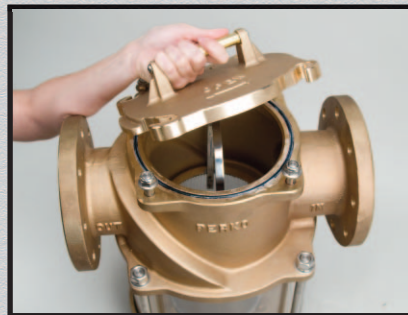

ORDERING & TECH INFO

Pipe Size Inches	Height Overall Inches	Width Overall Inches	Std. Pkg. 1 Pc.	Dimensions Cylinder Inches	Dimensions Basket Inches	Open Area To Pipe Size Ratio	Ship Wt. Carton Lbs. Std. Pkg.	Spare Gasket Kit* Std. Pkg. 1 Kit
4	17-1/2	16-1/2	0693012PLB	12 O.D. x 8-3/4	6-3/4 x 8-5/8	10:1	135.0	069301299R

*Spare Gasket Kit Consists of: 1 O-Ring for Cover and 2 Cylinder Gaskets

HEAVY DUTY 4" INTAKE WATER STRAINER SPARE PARTS

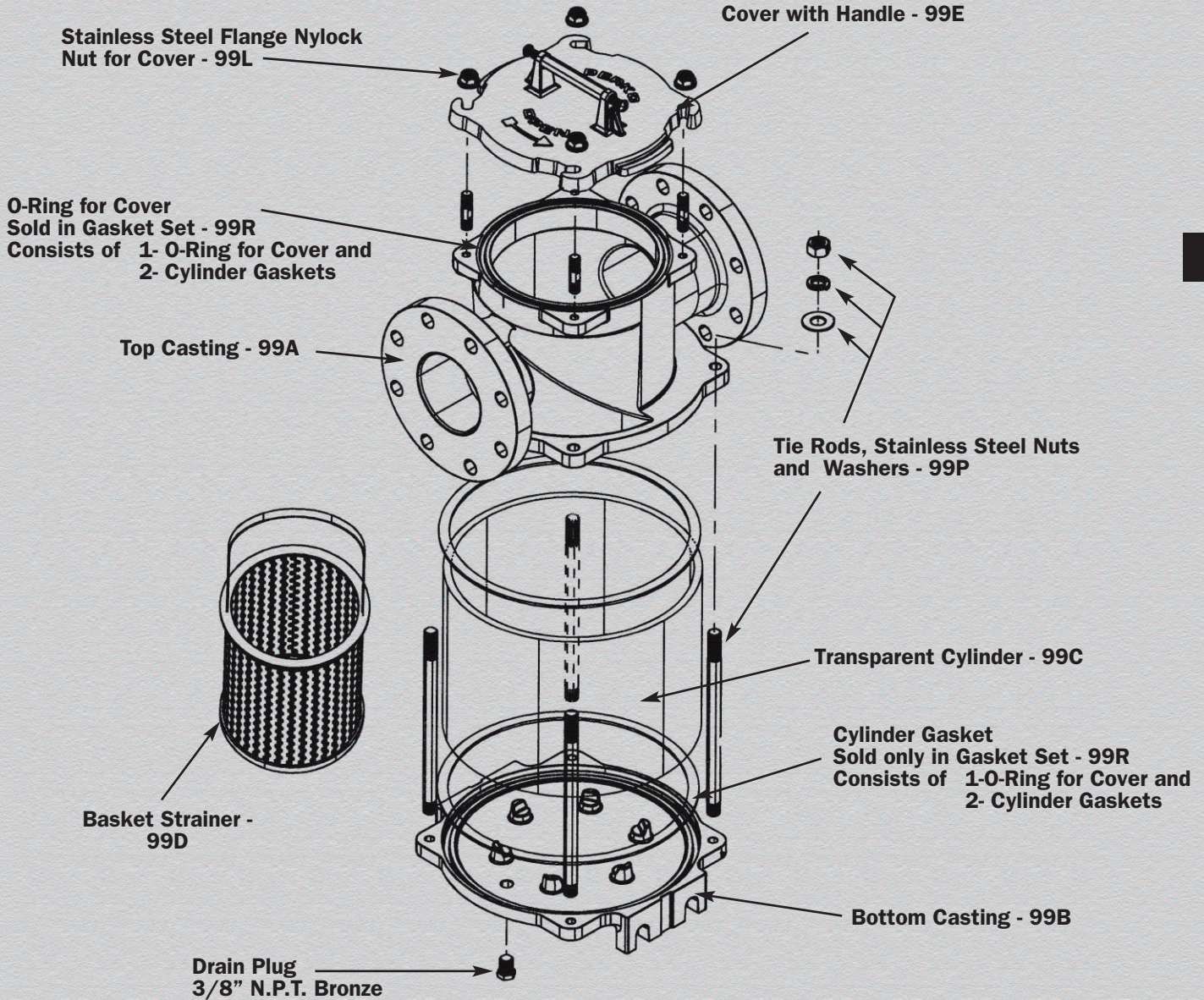

6

4" Intake Water Strainer Spare Parts Ordering Information

Description	Spare Part Code	Sample Part Number	Package	Description	Spare Part Code	Sample Part Number	Package
Top Casting	.99A	069301299A	Boxed	Gasket Kit Consists of: 1- Rubber O-Ring for Cover and 2- Rubber Cylinder Gaskets	.99R*	069301299R	Bag
Bottom Casting	.99B	069301299B	Boxed		Tie Rods, Nuts and Washers Consists of (1 Each for 0693 Series)99P	99P	069301299P
Transparent Cylinder	.99C	069301299C	Boxed				
Basket Strainer	.99D	069301299D	Boxed				
Cover with Handle	.99E	069301299E	Boxed				
Stainless Steel Flange Nylock Nut for Cover	.99L	069301299L	Bag				

PERKO® INTAKE WATER STRAINERS

PERKO Water Strainers are Designed for Easy Installation and Cleaning. Features Include Mounting Lugs Cast into Both Sides to Assure Universal Mounting, Four Outside Tie Rods and a 316 Stainless Steel Strainer Basket to Minimize Electrolysis. The diameter of the screen holes is 0.079" providing 47% open area, among the highest in the industry for cylindrical strainer baskets. Hinged Lugs for the Cast Bronze Cover Permit Easy Removal and Cleaning of the Strainer Basket. A Drain Plug in the Bottom Casting is Provided for Easily Removing Sediment and Draining for Winterizing. For Applications Requiring Higher Capacity, Use Fig. 0500.

Figs. 0493 & 0500
Intake Water Strainers
CONSTRUCTION:

- Cast Bronze



Fig. 0493



Fig. 0500



ORDERING & TECH INFO

Pipe Size Inches	Height Overall Inches	Width Overall Inches	Standard Pkg. - 1 Pc.	Dimensions Cylinder Inches O.D. x Height	Dimensions Basket Inches O.D. x Height	Open Area To Pipe Size Ratio	Ship Wt. Carton Lbs. Standard Pkg.	Spare Gasket Kit* Dealer Pkg. - 5 Kts. 1 Kit. per Bag
1/2	5-3/4	4-1/2	0493004PLB	3-1/2 x 4	1-13/16 x 4-3/8	30:1	4.9	0493DP599M (or) 99R
3/4	8-3/8	4-1/2	0493005PLB	3-1/2 x 6	1-13/16 x 6-1/4	25:1	5.0	0493DP599M (or) 99R
1	9-1/2	5-1/2	0493006PLB	4-1/2 x 5-1/2	2-5/8 x 5-7/8	20:1	8.1	0493DP799M (or) 99R
1-1/4	10	5-1/2	0493007PLB	4-1/2 x 6	2-5/8 x 6-1/4	13:1	7.9	0493DP799M (or) 99R
1-1/2	11-1/2	7-1/4	0493008PLB	6 x 8	3-5/16 x 8-7/16	17:1	13.7	0493DP999M (or) 99R
2	16	7-1/2	0493009PLB	6 x 12	3-5/16 x 12-1/4	13:1	19.5	0493DP999M (or) 99R
2-1/2	16	7-1/2	0493010PLB	6 x 12	3-5/16 x 12-1/2	10:1	18.0	0493DP999M (or) 99R

ORDERING & TECH INFO

Pipe Size Inches	Height Overall Inches	Width Overall Inches	Standard Pkg. - 1 Pc.	Dimensions Cylinder Inches O.D. x Height	Dimensions Basket O.D. x Height	Open Area To Pipe Size Ratio	Ship Wt. Carton Lbs. Standard Pkg.	Spare Gasket Kit* Standard Pkg. - 1 Kit
2	14-1/2	9	0500009PLB	8 x 10	3-7/8 x 10-1/4	20:1	36.0	0500DP999M (or) 99R
2-1/2	16-1/2	9	0500010PLB	8 x 12	3-7/8 x 12-1/4	18:1	33.5	0500DP999M (or) 99R
3	18-1/2	9	0500011PLB	8 x 14	3-7/8 x 14-1/4	14:1	34.0	0500DP999M (or) 99R

*Spare Gasket Kit Consists of: 1 Cover Gasket and 2 Cylinder Gaskets

INTAKE WATER STRAINER & FLUSHING STRAINER SPARE PARTS ORDERING INFORMATION

For Spare Part No. Insert a Spare Part Code Listed Below in Place of the "PLB" in the Strainer's Catalog Number (i.e., 049300699A, Top Casting for 1" (#6) Strainer).

Description	Spare Part Code	Sample Part Number	Package	Description	Spare Part Code	Sample Part Number	Package
Top Casting	.99A	049300499A	Boxed	Cork Gasket Kit Consists of: 1- Cover Gasket and 2- Cork Cylinder Gaskets	.99M*	0493DP599M	Bag
Bottom Casting	.99B	049300499B	Boxed		Rubber Gasket Kit Consists of: 1- Cover Gasket and 2- Rubber Cylinder Gaskets	.99R*	0493DP599R
Transparent Cylinder	.99C	049300499C	Boxed	Tie Rods, Nuts and Washers Consists of (4 Each for 0493 Series) (1 Each for 0500 Series)		.99P	0493DP499P
Basket Strainer	.99D	049300499D	Boxed				
Cover with Gasket	.99E	049300499E	Boxed				
Hinged Bolt for Cover							
With Pin, Nut and Washer	.99L	0493DP599L	Bag				
Cork Cover Gasket Kit (Set of 2)	.99N	0493DP599N	Bag				

* Note: Older model strainers utilizing cork cylinder gaskets must order 99M Cork Gasket Kit and newer model strainers must order 99R Rubber Gasket Kit.

INTAKE & FLUSHING WATER STRAINERS SPARE PARTS

Figs. 0493 & 0500 - Intake Water Strainers and Fig. 0593 Flushing Strainer Spare Parts Ordering Information

Fig. 0593 Flushing Strainer

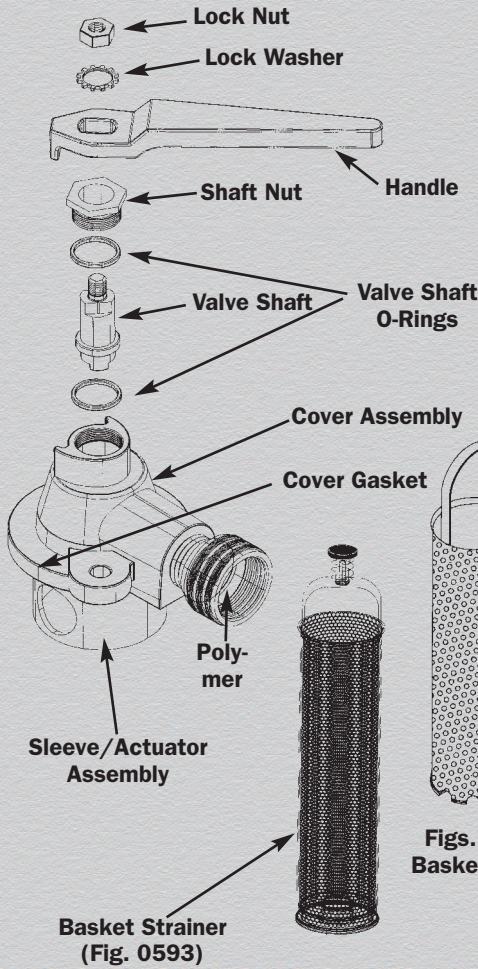

Figs. 0493 & 0500 Intake Strainer

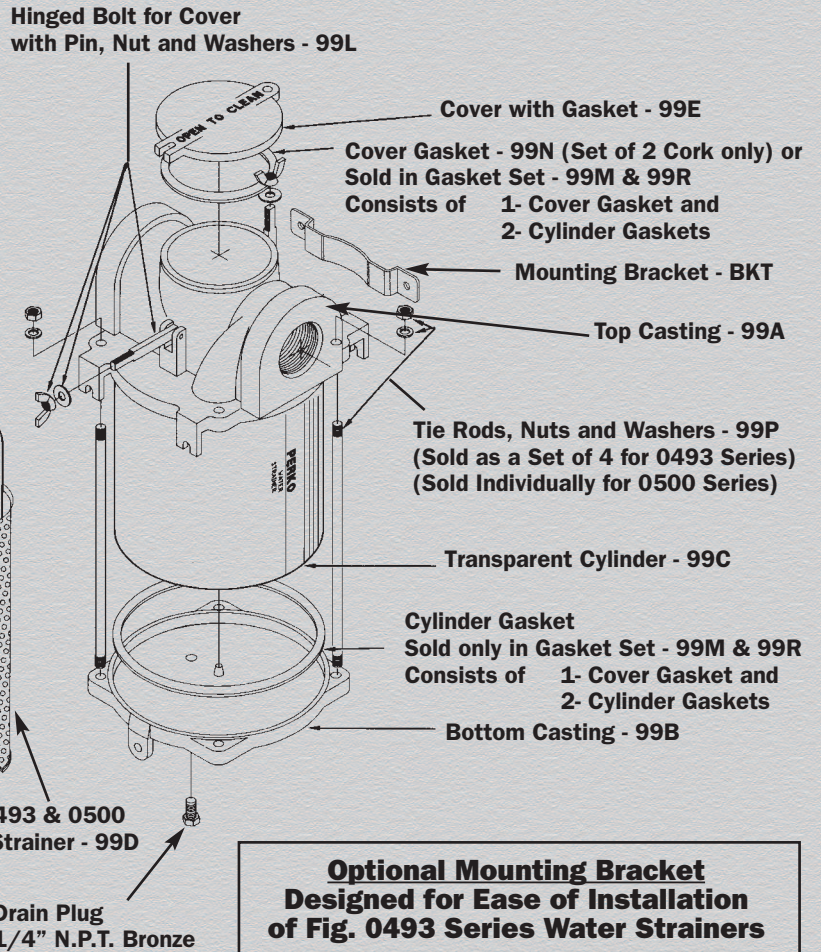

Optional Mounting Bracket Designed for Ease of Installation of Fig. 0493 Series Water Strainers



Part Number	Fits Strainer Size
0493045BKT	4 & 5
0493067BKT	6 & 7
0493089BKT	8 & 9

FIGS. 0493 & 0593 - DIFFERENTIAL PRESSURE GRAPHS

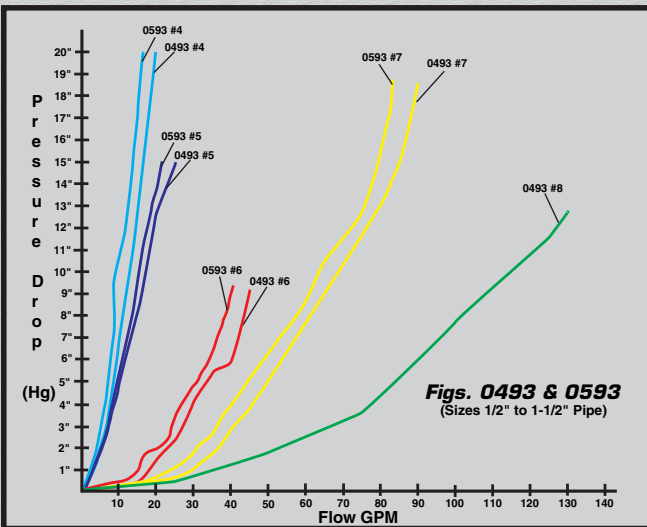

FIGS. 0493 & 0500 - DIFFERENTIAL PRESSURE GRAPHS

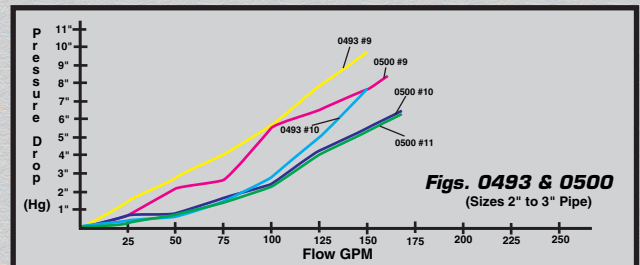

PERKO® FLUSHING STRAINER

PERKO Flushing Strainers are Designed for Easy Installation and Cleaning. Features Include Mounting Lugs Cast into Both Sides to Assure Universal Mounting, Four Outside Tie Rods and a 316 Stainless Steel Strainer Basket to Minimize Electrolysis. The diameter of the screen holes is 0.079" providing 47% open area, among the highest in the industry for cylindrical strainer baskets. Hinged Lugs for the Cast Bronze Cover Permit Easy Removal and Cleaning of the Strainer Basket. A Drain Plug in the Bottom Casting is Provided for Easily Removing Sediment and Draining for Winterizing.

Fig. 0593 - Flushing Strainer Fresh Water Flushes your Inboard or Generator Simply and Easily

CONSTRUCTION:

- Cast Bronze
- Available in 1/2", 3/4", 1", or 1-1/4" Pipe Sizes
- Uses Standard Perko Strainer Replacement Parts (Gaskets, Cylinders, Nuts and Tie Rods)
 - Handle Indicates Flow Direction
- Top Casting Removes Easily for Basket Cleaning
 - Reversible Bulkhead Mounting Option
 - Smooth Acting, Low Torque Ball Valve
- Internal Cam Seals Fresh Water Intake During Normal (Through Strainer) Operation
- **Can Act as an Emergency Bilge Pump**



Fig. 0593

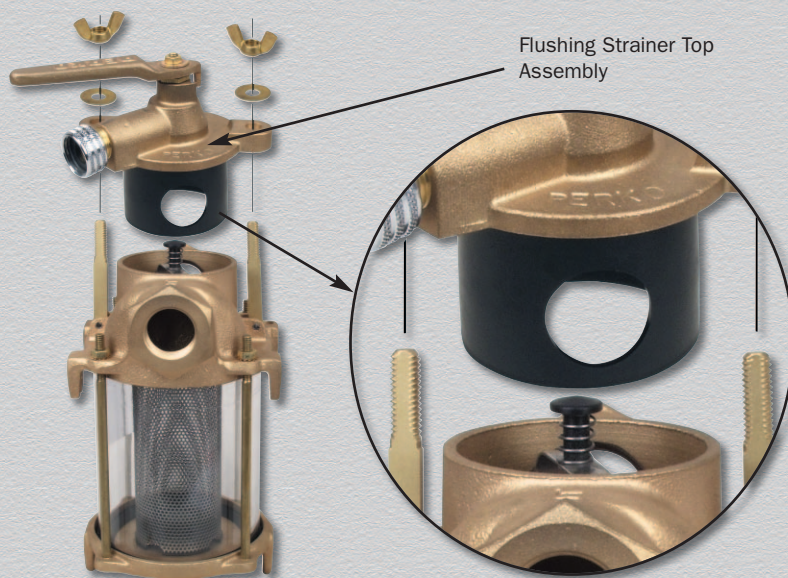

ORDERING & TECH INFO

Pipe Size Inches	Height Overall Inches	Width Overall Inches	Standard Pkg. - 1 Pc.	Dimensions Cylinder Inches	Dimensions Basket Inches	Open Area To Pipe Size Ratio	Weight Pounds	Spare Gasket Kit* Dealer Pkg. - 5 Kts. 1 Kit per Bag
1/2	5-3/4	4-1/2	0593004PLB	3-1/2 x 4	1-13/16 x 4-3/8	30:1	5.9	0493DP599R
3/4	8-3/8	4-1/2	0593005PLB	3-1/2 x 6	1-13/16 x 6-1/4	25:1	6.2	0493DP599R
1	9-1/2	5-1/2	0593006PLB	4-1/2 x 5-1/2	2-5/8 x 5-7/8	20:1	9.1	0493DP799R
1-1/4	10	5-1/2	0593007PLB	4-1/2 x 6	2-5/8 x 6-1/4	13:1	9.1	0493DP799R

Flushing Strainer Spare Parts Ordering Information

Description	Spare Part			Sample			
	Code	Part Number	Package	Description	Code	Part Number	Package
Handle (Fig. 0805)	99D	080500599D**	Boxed	Sleeve Assy.	99B	059300499B	Boxed
Valve Shaft	99A	059300499A	Boxed	Cover Assy.	99C	059300499C	Boxed

See Pages 146-147 For Additional Spare Parts Ordering Information and Differential Pressure Graphs.

*Spare Gasket Kit Consists of: 1 Cover Gasket and 2 Cylinder Gaskets.

** For Complete Handle Part Numbers See Fig. 0805 on page 154.

Fig. 0456 - FlushPro™ Marine Engine Flushing & Winterizing Valve
Fig. 0457 - FlushPro™ Marine Engine Flushing & Winterizing Kit

CONSTRUCTION:

- Polymer
- Stainless Steel Spring
- Available for Standard 5/8", 1" or 1-1/4" Hose Sizes

FINALLY!
FRESHWATER FLUSHING OF
YOUR INBOARD IS AS SIMPLE AS
CONNECTING A GARDEN HOSE

- Flush your boat engine safely and easily
- Transparent body allows for visual inspection of water flow
- Durable check valve system activated by water pressure from a garden hose
- Check valve automatically shuts off hull intake when water pressure is applied
- Adapter supplied with FlushPro™ makes winterizing your boat easy
- Can be used with onboard generators

Fig. 0456



6

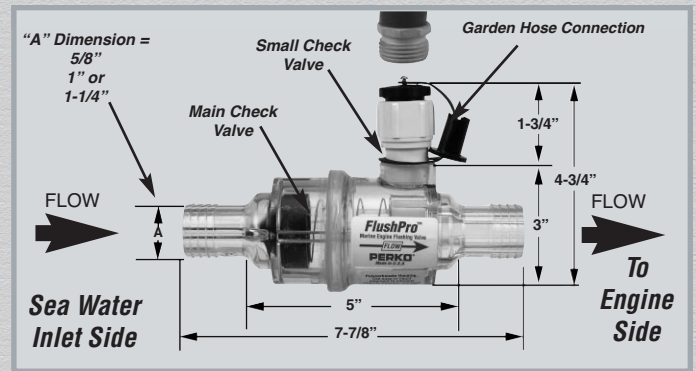
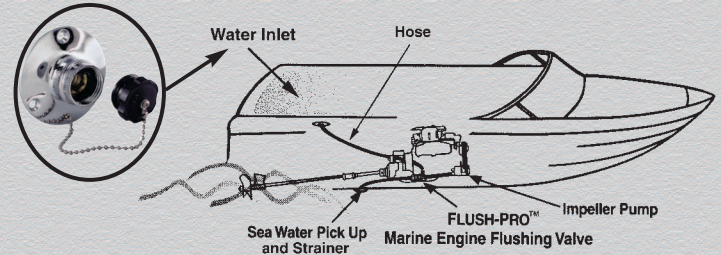
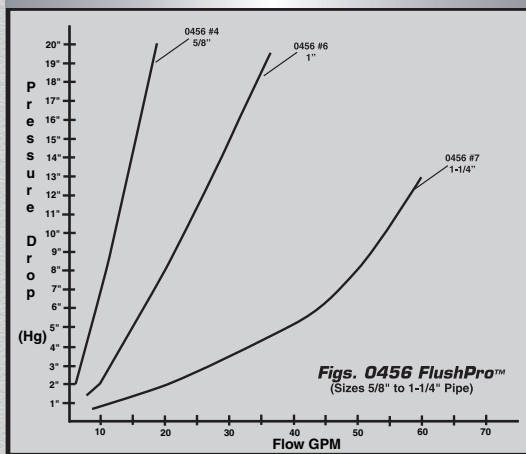

FIG. 0456 - DIFFERENTIAL PRESSURE GRAPH



Hose Fittings and Clamps



7 Feet of Hose

Fig. 0457
Kit Includes:

FlushPro™ Valve with Hose Clamps



Water Inlet Fitting

ORDERING & TECH INFO

Includes	"A" Dimension For Hose Size Inches	Dealer Pkg. 1 Pc.	OEM Bulk Pkg. 5 Pcs.	Ship Wt. Carton Lbs. DP/OEM Bulk Pkg.
Valve	5/8	0456DP4	0456004	1.3/3.5
Valve	1	0456DP6	0456006	1.4/3.6
Valve	1-1/4	0456DP7	0456007	1.5/3.7
Valve & Kit	5/8	0457DP4	0457004	2.9/11.5
Valve & Kit	1	0457DP6	0457006	3.0/11.6
Valve & Kit	1-1/4	0457DP7	0457007	3.1/11.7

UNDERWATER HARDWARE PACKAGING AND THREAD STYLES

UNDERWATER HARDWARE PACKAGING

Here is the newest member of the Perko packaging program – the Perko hang tag. These durable little tags have everything a retailer needs to showcase products and ring up sales. On each tag you will find the Perko name colorfully printed in blue, our figure number, a product description and the bar code for your scanner. There is even a California Proposition 65 statement (where applicable) on the back. These tags are designed to securely hold on to the product and hang from your standard peg hooks. And since the tags are small, you can also simply toss them into a bulk bin if you prefer. Either way, the tags will stay attached, unlike stickers that fall off bronze parts. These tags are available on thru hulls, adapters and several types of strainers. Look for the "DP" designation. Our "DP" Dealer Package for small items (like the smaller thru hull fittings and tailpieces) will be a 5 or 10 piece bulk box with a bar code label on each individual unit. **THESE 5 OR 10 PIECE CARTONS CANNOT BE BROKEN.** Larger items (like valves & strainers) will be available individually boxed as a single unit standard package with a bar code label on the outside of the box.

To be sure the parts you receive are bar coded for Retail Sale, order either a "DP" version or a single unit standard package.



All of our small repair/replacement strainer parts are now bar coded. Top Castings (99A), Bottom Castings (99B), Transparent Cylinders (99C), Strainer Baskets (99D) and Covers (99E) are available individually boxed as bar coded single unit standard packages. Smaller items or kits including Cover Hardware Kits (99L), Gasket Kits (99M & 99R) and Tie Rod Kits (99P) are individually packaged as "DP" items in bags with a bar code label.

UNDERSTANDING UNDERWATER HARDWARE PIPE THREAD STYLES

Straight Pipe Threads

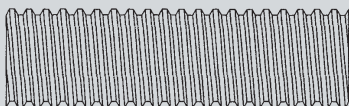

Straight pipe threads are used where connections are purely mechanical and/or bedding compounds are generally used. The intake side of all Seacocks, thru-hulls and scuppers with hose barbs, and all flanged lock nuts use straight threads.

Tapered Pipe Threads

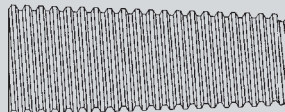

Tapered pipe threads are used where connections must also be watertight. The output side of Seacocks, in-line valves, hose adapters, drain plugs, raw water and pump strainers use tapered threads.

Combination Tapered/Straight Pipe Threads

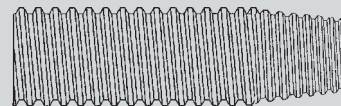

On all other thru-hulls, scuppers and intake strainers we use a unique combination pipe thread. The first few threads are tapered. The rest remain straight threads. This approach allows the same thru-hull to seal when coupled with an in-line valve or to engage at various depths when connected to a Seacock.



Fig. 0065 - Intake Strainer

CONSTRUCTION:

- Cast Bronze
- Machined Slots

ORDERING & TECH INFO

Max. Pipe Size Inches	Max. Hull Thickness Inches	Dimensions Strainer Inches	Dealer Pkg. 5 Pcs.	OEM Bulk Pkg. 10 Pcs.	Ship Wt. Carton Lbs. DP/OEM Bulk
1/2	2-1/4	3 x 4	0065DP4PLB	0065004PLB	3.8/7.3
3/4	2-3/16	3 x 4	0065DP5PLB	0065005PLB	5.8/11.3
1	2-1/2	3 x 4	0065DP6PLB	0065006PLB	7.7/15.0
1-1/4	3	3-1/4 x 4-1/4	0065DP7PLB	0065007PLB	9.8/18.4

Fig. 0065

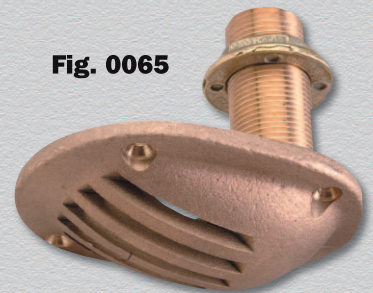

6

Screw Size #8.

Spare Flanged Nut See Fig. 0075, on page 161

Fig. 0066 - Scoop Strainer

CONSTRUCTION:

- Cast Bronze
- Machined Slots

ORDERING & TECH INFO

For Thru-Hull Sizes Inches	Dimensions Strainer Inches	Dealer Pkg. 5 Pcs.	Standard Package - 5 Pcs.	Ship Wt. Carton Lbs. DP/Std. Pkg.
3/8 & 1/2	3-1/2 x 2-1/2	0066DP1PLB	0066001PLB	2.7/2.6
3/4 & 1	5 x 3-1/4	0066DP2PLB	0066002PLB	4.4/4.3
1-1/4 & 1-1/2	6-1/4 x 4-1/4	0066DP3PLB	0066003PLB	7.4/7.5
2	8 x 5-1/8	0066DP4PLB	0066004PLB	9.7/9.8

Screw Size #8



Fig. 0066

Fig. 0086 - Round Strainer

CONSTRUCTION:

- Cast Bronze
- Drilled Holes

ORDERING & TECH INFO

For Thru-Hull Size Inches	O.D. Inches	I.D. Inches	Dealer Pkg. 5 Pcs.	Standard Package - 5 Pcs.	Screw Size	Ship Wt. Carton Lbs. DP/Std. Pkg.
3/8 & 1/2	2-1/2	1-5/8	0086DP1PLB	0086001PLB	8	1.2/1.2
3/4	3	2	0086DP2PLB	0086002PLB**	8	1.9/8.8
1	3-1/2	2-3/8	0086DP3PLB	0086003PLB	8	1.7/1.7
1-1/4 & 1-1/2	4	3	0086DP4PLB	0086004PLB	8	2.9/2.8
2	5	3-3/4	0086DP5PLB	0086005PLB	8	4.5/4.3
2-1/2	6	4-1/2	—	0086006PLB*	10	—/1.3
3	8	6-1/4	—	0086007PLB*	10	—/2.7

* Standard Package - 1 pc.

** Standard Package - 25 pcs.



Fig. 0086

PUMP STRAINERS & GARBOARD DRAIN PLUG

Fig. 0709 - Pump Strainer



Fig. 0709

CONSTRUCTION:

- Cast Bronze

ORDERING & TECH INFO

Hose Size Inches	Length Overall Inches	Width Overall Inches	Dealer Pkg. 5 Pcs.	Ship Wt. Carton Lbs. Dealer Pkg.
5/8	3-5/8	1-3/4	0709DP0PLB	2.9

6

Figs. 0721 & 0722 - Pump Strainers

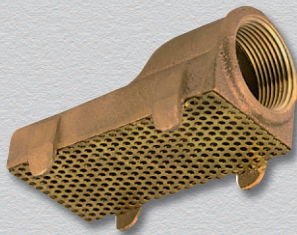

Fig. 0721

CONSTRUCTION:

- Cast Bronze

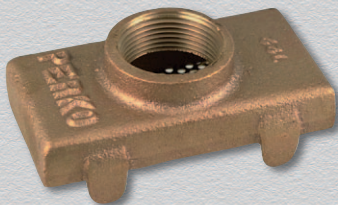

Fig. 0722

ORDERING & TECH INFO

Pipe Size Inches	Length Overall Inches	Width Overall Inches	Standard Package - 1 Pc.	Ship Wt. Carton Lbs. Standard Pkg.
1-1/4	4-3/4	2-3/4	0721000PLB	1.7
1-1/4	4-1/2	2-3/4	0722000PLB	1.5



Fig. 0124 - Garboard Drain Plug

CONSTRUCTION:

- Cast Bronze Flange
- Brass Plug
- Zinc-Alloy Plated Steel Wrench

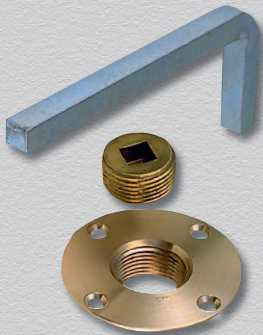

Fig. 0124

ORDERING & TECH INFO

Pipe Size Inches	Length Threaded Neck Inches	O.D. Flange Inches	Standard Package - 5 Pcs.	Screw Size	Ship Wt. Carton Lbs. Standard Pkg.
1	1	3-1/8	0124000PLB	10	6.2

SPARE PARTS ORDERING INFORMATION

Wrench: 012400099A

Plug: 012400099B



Fig. 0266 - Garboard Drain Plug

CONSTRUCTION:

- Cast Bronze

ORDERING & TECH INFO						
Pipe Size Inches	Length Threaded Neck Inches	O.D. Flange Inches	Dealer Pkg. 5 Cards 1 Pc. per Card	OEM Bulk Pkg. 25 Pcs.	Screw Size	Ship Wt. Carton Lbs. DP/OEM Bulk
3/4	5/8	2-3/8	0266DP0PLB	0266000PLB	8	4.0/17.7

Spare Plug: 0370DP0PLB.



Fig. 0266

6

Fig. 0363 - Garboard Drain Plug

CONSTRUCTION:

- Cast Bronze

ORDERING & TECH INFO						
Pipe Size Inches	Maximum Hull Thickness Inches	Length Threaded Neck Inches	O.D. Flange Inches	Dealer Pkg. 5 Cards 1 Pc. per Card	OEM Bulk Pkg. 25 Pcs.	Ship Wt. Carton Lbs. DP/OEM Bulk
3/4	3/4	1-1/4	2-3/8	0363DP0PLB	0363000PLB	5.2/23.2

Spare Plug: 0370DP0PLB.



Fig. 0363



Figs. 0714 & 0737 - Garboard Drain Plugs

CONSTRUCTION:

- Cast Bronze Flange with Brass Plug

Fig. 0737

Complete with Brass Backing Plate and Fasteners

ORDERING & TECH INFO					
Pipe Size Inches	O.D. Flange Inches	Dealer Pkg. 5 Cards 1 Pc. per Card	OEM Bulk Pkg. 50 Pcs.	Screw Size	Ship Wt. Carton Lbs. DP/OEM Bulk
1/2	2	0714DP1PLB	0714001PLB	8	1.6/12.9
Pipe Size Inches	Hull Thickness Inches	O.D. Flange Inches	Dealer Pkg. 5 Cards 1 Pc. per Card	Screw Size	Ship Wt. Carton Lbs. Dealer Pack
1/2	7/16	2	0737DP1PLB	8-32	1.9

Spare Plug: 0742DP1



Fig. 0714



Fig. 0737



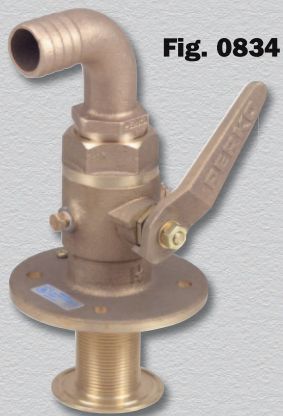

Fig. 0834



Fig. 0835

Figs. 0834 & 0835 - Seacocks - Ball Valve Design

CONSTRUCTION:

- Cast Bronze

Fig. 0834 - With 90° Curved Hose Adapter

Fig. 0835 - With Straight Hose Adapter

Includes Thru-Hull, Hose Adapter, Drain Plug, Four Pre-Drilled Mounting Holes and Bonding Screw.

PERKO Seacocks Incorporate a Polymer Ball and Seat Assuring a Tight Seal and Ease of Operation, and Drain Plugs for Winterizing. Handles are Easily Removed.

6

ORDERING & TECH INFO

Hose Size Inches	Pipe Size Inches	Flange Dia. Inches	Fig. 0834 Overall Height*	Fig. 0834 Standard Pkg. - 1 Pc.	Ship Wt. Carton Lbs. Standard Pkg.	Fig. 0835 Overall Height*	Fig. 0835 Standard Pkg. - 1 Pc.	Bolt Size	Ship Wt. Carton Lbs. Standard Pkg.
3/4	3/4	3-1/4	5-7/8	0834005PLB	3.1	5	0835005PLB	5/16	2.9
1	1	4-3/8	6-3/8	0834006PLB	5.2	5-3/8	0835006PLB	3/8	4.8
1-1/4	1-1/4	4-7/8	7-5/8	0834007PLB	7.2	6-1/4	0835007PLB	3/8	6.7
1-1/2	1-1/2	5-1/2	8-3/8	0834008PLB	9.1	6-5/8	0835008PLB	3/8	8.7
2	2	5-3/4	10-3/8	0834009PLB	15.6	7-7/8	0835009PLB	3/8	14.3
2-1/2	2-1/2	7-1/4	12-1/2	0834010PLB	27.9	10-3/8	0835010PLB	1/2	25.0
3	3	8	14-3/8	0834011PLB	33.4	12	0835011PLB	1/2	30.0

* Overall Height is measured from the top of the hose adapter to the bottom of the flange.

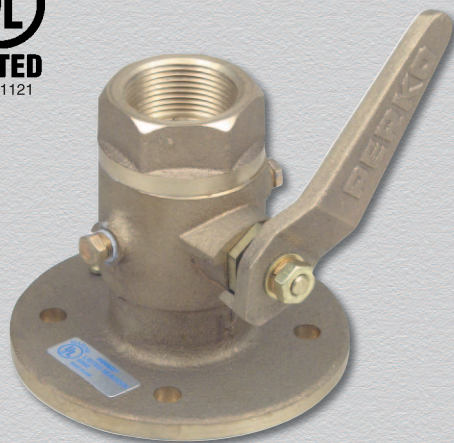

Fig. 0805

Fig. 0805 - Seacock Body - Ball Valve Design

CONSTRUCTION:

- Cast Bronze

These Valve Bodies are Offered to Meet the Needs of Applications that Require Extra Long, Scoop or Flush Type Thru-Hulls.

ORDERING & TECH INFO

Flange Diameter Inches	Overall Height Inches*	Pipe Size Inches	Fig. 0805 Standard Pkg. - 1 Pc.	Ship Wt. Carton Lbs. Standard Pkg.
3-1/4	3-3/8	3/4	0805005PLB	2.3
4-3/8	3-3/4	1	0805006PLB	3.9
4-7/8	4-1/4	1-1/4	0805007PLB	5.3
5-1/2	4-1/2	1-1/2	0805008PLB	6.7
5-3/4	5-3/4	2	0805009PLB	11.5
7-1/4	7-1/2	2-1/2	0805010PLB	20.0
8	7-3/4	3	0805011PLB	23.3

* Overall Height is measured from the top of the valve body to the bottom of the flange.

SPARE PARTS ORDERING INFORMATION

The Repair Kits Listed Below Consist of: 1 Ball, 2 Ball Seats and 2 O-Rings for the Valve Stem.

Pipe Size Inches	Repair Kit Part No.	Pipe Size Inches	Repair Kit Part No.	Handle Size	Part No.
3/4	080500599B	2-1/2	080501099B	Size 7	080500799D
1	080500699B	3	080501199B	Size 8	080500899D
1-1/4	080500799B	Handle	Part No.	Size 9	080500999D
1-1/2	080500899B	Size 5	080500599D	Size 10	080501099D
2	080500999B	Size 6	080500699D	Size 11	080501199D

PERKO® IN LINE VALVE & PIPE TO HOSE ADAPTERS

Fig. 0825 - Inline Valve

CONSTRUCTION:

- Cast Bronze
- Drain Plug and Bonding Screw Included
- Ball Valve for Smooth Operation

ORDERING & TECH INFO

Pipe Size Inches	Standard Package - 1 Pc.	Ship Wt. Carton Lbs. Std Pkg.
1/2	0825004PLB	1.0
3/4	0825005PLB	1.2
1	0825006PLB	1.8
1-1/4	0825007PLB	2.8
1-1/2	0825008PLB	4.1



Fig. 0825

6

Fig. 0063 - Pipe to Hose Adapter

CONSTRUCTION:

- Cast Bronze
- Cast Hex for Easier Installation
- Curved 90 Degrees

ORDERING & TECH INFO

Pipe Size Inches	Hose Size Inches	Length Overall Inches	Dealer Pkg. 5 Pcs.	Standard Package 1 Pc.	OEM Bulk Pkg.	OEM Bulk Pkg. Pcs.	Ship Wt. Carton Lbs. DP/Std./OEM Bulk
3/4	3/4	4-1/2	0063DP5PLB	—	0063005PLB	25	2.1/-/9.1
1	1	4-3/4	0063DP6PLB	—	0063006PLB	25	3.7/-/16.9
1-1/4	1-1/4	5-1/2	0063DP7PLB	—	0063007PLB	25	5.5/-/25.3
1-1/2	1-1/2	6	0063DP8PLB	—	0063008PLB	10	7.5/-/13.5
2	2	7	—	0063009PLB	0063009PLB	10	-/2.9/27.1
2-1/2	2-1/2	8-1/2	—	0063010PLB	—	—	-/3.9/-
3	3	10	—	0063011PLB	—	—	-/6.9/-



Fig. 0063



NOTE: The Above Item Meets the Requirements of U.S.C.G. Safety Standards, January 31, 1977 for Gasoline Fuel Systems, 33 CFR 183.

Fig. 0076 - Pipe to Hose Adapter

CONSTRUCTION:

- Cast Bronze
- Cast Hex for Easier Installation
- Precision Machined Hose Barb

ORDERING & TECH INFO

Pipe Size Inches	Hose Size Inches	Length Overall Inches	Dealer Pkg. 5 Pcs.	Standard Pkg. - 1 Pc.	OEM Bulk Pkg. 25 Pcs.	Ship Wt. Carton Lbs. DP/Std./OEM Bulk
1/2	5/8	1-5/8	0076DP4PLB	—	0076004PLB	0.9/-/3.5
3/4	3/4	1-3/4	0076DP5PLB	—	0076005PLB	1.1/-/4.7
1	1	1-3/4	0076DP6PLB	—	0076006PLB	1.9/-/7.9
1-1/4	1-1/4	2	0076DP7PLB	—	0076007PLB	2.6/-/11.9
1-1/2	1-1/2	2-1/4	0076DP8PLB	—	0076008PLB	3.9/-/18.6
2	2	2-5/8	—	0076009PLB	0076009PLB	-/1.3/26.7
2-1/2	2-1/2	4	—	0076010PLB	—	-/2.0/-
3	3	5-1/8	—	0076011PLB	—	-/3.2/-



Fig. 0076



NOTE: The Above Item Meets the Requirements of U.S.C.G. Safety Standards, January 31, 1977 for Gasoline Fuel Systems, 33 CFR 183.



Fig. 0350 - Thru-Hull Connection For Use with Hose**

CONSTRUCTION:

- Cast Bronze
- Plain or Chrome Plated

**Flange is Machined to Fit Hull and Grooved to Retain Bedding Compound
Neck is Threaded to Approximately 3/16 Inch From Flange.**

Fits Maximum Hull Thickness up to 2 Inches.

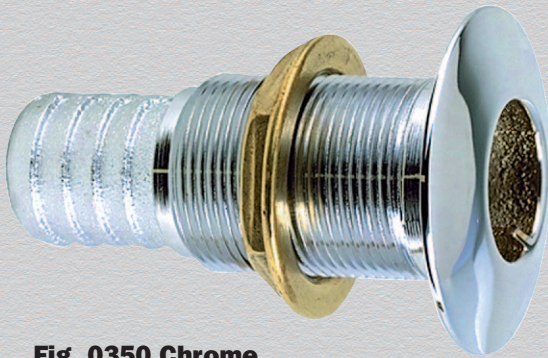

Fig. 0350 Chrome

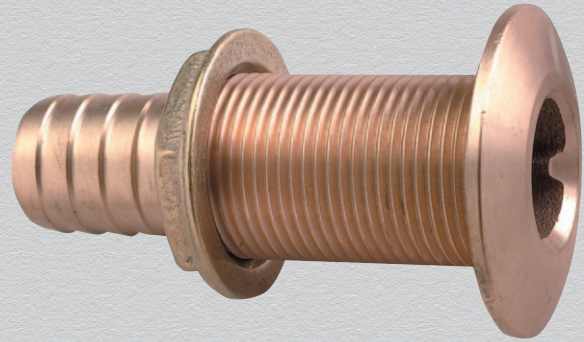

Fig. 0350 Plain



**Illustration Of
Bedding Groove**

ORDERING & TECH INFO

PLAIN BRONZE

Hose Size Inches	Mounting Hole Dia. Inches	Max. Hull Thickness Inches	O.D. Flange Inches	Dealer Pkg. 5 Pcs.	OEM Bulk Pkg. 10 Pcs.	Ship Wt. Carton Lbs. DP/OEM Bulk
5/8	13/16	1-1/16	1-1/2	0350004DPP	0350004PLB	1.9/3.3
3/4	1	1-5/8	1-7/8	0350005DPP	0350005PLB	2.9/5.5
1	1-5/16	1-3/4	2-1/4	0350006DPP	0350006PLB	4.7/8.6
1-1/8	1-5/16	1-3/4	2-1/4	035006ADPP	035006APLB	4.9/9.0
1-1/4	1-5/8	1-7/8	2-3/4	0350007DPP	0350007PLB	6.6/12.6
1-1/2	1-7/8	1-7/8	3-1/8	0350008DPP	0350008PLB	8.3/15.9
2	2-3/8	2	3-3/4	—	0350009PLB*	-/2.5

CHROME PLATED BRONZE

Hose Size Inches	Mounting Hole Dia. Inches	Max. Hull Thickness Inches	O.D. Flange Inches	Dealer Pkg. 5 Pcs.	OEM Bulk Pkg. 10 Pcs.	Ship Wt. Carton Lbs. DP/OEM Bulk
5/8	13/16	1-1/16	1-1/2	0350004DPC	0350004CHR	1.9/3.3
3/4	1	1-5/8	1-7/8	0350005DPC	0350005CHR	2.9/5.5
1	1-5/16	1-3/4	2-1/4	0350006DPC	0350006CHR	4.6/8.4
1-1/8	1-5/16	1-3/4	2-1/4	035006ADPC	035006ACHR	4.9/9.0
1-1/4	1-5/8	1-7/8	2-3/4	0350007DPC	0350007CHR	6.7/12.9
1-1/2	1-7/8	1-7/8	3-1/8	0350008DPC	0350008CHR	8.2/16.1
2	2-3/8	2	3-3/4	—	0350009CHR*	-/2.5

*OEM Bulk Pkg. 1 Pc.

Spare Flanged Nut See Fig. 0075, on page 161.

**NOTE: Thru-Hull Connections For Use With Hose Are Not Recommended For Use Below The Waterline Per A.B.Y.C. "Safety Standards For Small Craft" Section H-27.



Fig. 0331 - Flush Mount Thru-Hull Connection For Use with Pipe

CONSTRUCTION:

- Cast Bronze

The exterior surface of the flange is machined flat and designed to be countersunk into the hull, resulting in a smooth external fit with no raised portion to increase drag.



Fig. 0331

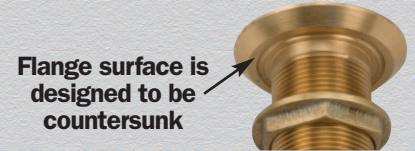

ORDERING & TECH INFO

Pipe Size Inches	Mounting Hole Dia. Inches	Max. Hull Thickness Inches	O.D. Flange Inches	Dealer Pkg. 5 Pcs.	OEM Bulk Package	OEM Bulk Pkg. Qty	Ship Wt. Carton Lbs. DP/OEM Bulk
1/2	13/16	2-3/16	1-11/16	0331DP4PLB	0331004PLB	10	2.3/4.6
3/4	1	2-3/8	2	0331DP5PLB	0331005PLB	10	2.8/5.4
1	1-5/16	2-9/16	2-1/4	0331DP6PLB	0331006PLB	10	3.9/7.0
1-1/4	1-5/8	2-15/16	2-7/8	0331DP7PLB	0331007PLB	10	6.7/12.8
1-1/2	1-7/8	3-1/16	2-31/32	0331DP8PLB	0331008PLB	10	7.3/13.0
2	2-3/8	3-3/8	3-7/8	—	0331009PLB	1	-/2.3

Spare Flanged Nut See Fig. 0075, on page 161.

6

Fig. 0348 - Extra Long Thru-Hull Connection For Use with Pipe

CONSTRUCTION:

- Cast Bronze

Flange is Machined to Fit Hull and Grooved to Retain Bedding Compound. Neck is Threaded to Approximately 3/8 Inch From Flange.

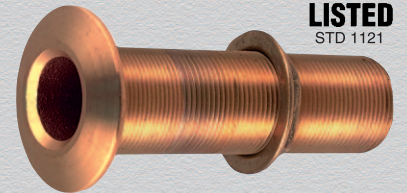

Fig. 0348



Illustration Of Bedding Groove

ORDERING & TECH INFO

Pipe Size Inches	Mounting Hole Dia. Inches	Max. Hull Thickness Inches	O.D. Flange Inches	Dealer Pkg. 5 Pcs.	OEM Bulk Package	OEM Bulk Pkg. Qty	Ship Wt. Carton Lbs. DP/OEM Bulk
3/4	1	5	1-7/8	0348DP5PLB	0348005PLB	25	4.3/19.3
1	1-5/16	4-7/8	2-1/4	0348DP6PLB	0348006PLB	10	5.7/10.9
1-1/4	1-5/8	4-5/8	2-3/4	0348DP7PLB	0348007PLB	10	9.1/17.5
1-1/2	1-7/8	4-5/8	3	0348DP8PLB	0348008PLB	10	10.4/20.1
2	2-3/8	4-1/2	3-5/8	—	0348009PLB	1	-/2.8
2-1/2	2-7/8	4-1/4	4-5/16	—	0348010PLB	1	-/3.6

Spare Flanged Nut See Fig. 0075, on page 161.

Fig. 0322 - Thru-Hull Connection For Use with Pipe

CONSTRUCTION:

- Cast Bronze

Flange is Machined to Fit Hull and Grooved to Retain Bedding Compound. Neck is Threaded to Approximately 3/8 Inch From Flange.

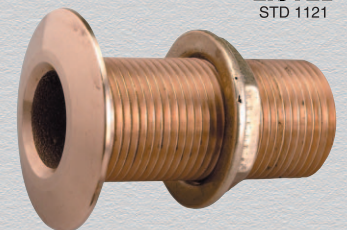

Fig. 0322



Illustration Of Bedding Groove

ORDERING & TECH INFO

Pipe Size Inches	Mounting Hole Dia. Inches	Max. Hull Thickness Inches	O.D. Flange Inches	Dealer Pkg. 5 Pcs.	Standard Pkg. - 1 Pc.	OEM Bulk Pkg. 25 Pcs.	Ship Wt. Carton Lbs. DP/Std/OEM
3/8	11/16	1-3/4	1-7/16	0322DP3PLB	—	0322003PLB	1.7/-/6.9
1/2	13/16	1-3/8	1-1/2	0322DP4PLB	—	0322004PLB	1.8/-/7.9
3/4	1	1-1/2	1-7/8	0322DP5PLB	—	0322005PLB	2.4/-/11.6
1	1-5/16	1-7/8	2-3/16	0322DP6PLB	—	0322006PLB	4.1/-/18.7
1-1/4	1-5/8	2	2-3/4	0322DP7PLB	—	0322007PLB	6.0/-/28.5
1-1/2	1-7/8	2-1/4	3	0322DP8PLB	—	0322008PLB*	7.6/-/15.0
2	2-3/8	2-3/8	3-5/8	—	0322009PLB	0322009PLB*	-/2.1/19.4
2-1/2	2-7/8	2-5/8	4-1/2	—	0322010PLB	—	-/2.8/-
3	3-1/2	2-3/4	5	—	0322011PLB	—	-/4.6/-

* O.E.M. Bulk Pkg. - 10 pcs.

Spare Flanged Nut See Fig. 0075, on page 161.



Fig. 0301 - Thru-Hull Connection For Use with Hose**

CONSTRUCTION:

- Molded White or Black Polymer
- Narrow Flange

ORDERING & TECH INFO

White Polymer

Hose Size Inches	Mounting Hole Dia. Inches	Max. Hull Thickness Inches	O.D. Flange Inches	Dealer Pkg. 10 Pcs.	OEM Bulk Pkg. 100 Pcs.	Ship Wt. Carton Lbs. DP/OEM Bulk
1/2	13/16	1-1/4	1-1/4	0301DP4	0301004	0.8/5.0
5/8	13/16	1-1/4	1-1/4	0301DP4A	030104A	0.9/5.1
3/4	1	1-7/16	1-1/2	0301DP5	0301005	1.2/7.6
1	1-5/16	1-1/2	1-7/8	0301DP6	0301006*	1.7/6.1
1-1/8	1-5/16	1-1/2	1-7/8	0301DP6A	030106A*	1.6/6.2
1-1/2	1-7/8	1-7/8	2-1/2	0301DP8	0301008*	3.4/14.0

Black Polymer

Hose Size Inches	Mounting Hole Dia. Inches	Max. Hull Thickness Inches	O.D. Flange Inches	OEM Bulk Pkg. 100 Pcs.	Ship Wt. Carton Lbs. OEM Bulk
1/2	13/16	1-1/4	1-1/4	0301004BLK	5.0
5/8	13/16	1-1/4	1-1/4	030104ABLK	5.1
3/4	1	1-7/16	1-1/2	0301005BLK	7.6
1	1-5/16	1-1/2	1-7/8	0301006BLK*	6.1
1-1/8	1-5/16	1-1/2	1-7/8	030106ABLK*	6.2
1-1/2	1-7/8	1-7/8	2-1/2	0301008BLK*	14.0

* OEM Bulk Pkg. - 50 pcs.

Spare Flanged Nut See Fig. 0326 on Page 161.



Fig. 0301
Black

Fig. 0301
White

6



Fig. 0328 - Thru-Hull Connection For Use with Hose**

CONSTRUCTION:

- Molded White or Black Polymer
- Broad Flange

ORDERING & TECH INFO

White Polymer

Hose Size Inches	Mounting Hole Dia. Inches	Max. Hull Thickness Inches	O.D. Flange Inches	Dealer Pkg. 10 Pcs.	OEM Bulk Pkg. 100 Pcs.	Ship Wt. Carton Lbs. DP/OEM Bulk
1/2	13/16	1-1/4	1-1/2	0328DP4	0328004	0.9/5.8
5/8	13/16	1-1/4	1-1/2	0328DP4A	032804A	1.0/6.1
3/4	1	1-7/16	1-7/8	0328DP5	0328005	1.3/8.7
1	1-5/16	1-1/2	2-1/4	0328DP6	0328006*	2.0/7.0
1-1/8	1-5/16	1-1/2	2-1/4	0328DP6A	032806A*	2.0/7.0
1-1/2	1-7/8	1-7/8	3	0328DP8	0328008*	3.7/16.0

Black Polymer

Hose Size Inches	Mounting Hole Dia. Inches	Max. Hull Thickness Inches	O.D. Flange Inches	OEM Bulk Pkg. 100 Pcs.	Ship Wt. Carton Lbs. OEM Bulk
1/2	13/16	1-1/4	1-1/2	0328004BLK	5.8
5/8	13/16	1-1/4	1-1/2	032804ABLK	6.1
3/4	1	1-7/16	1-7/8	0328005BLK	8.7
1	1-5/16	1-1/2	2-1/4	0328006BLK*	7.0
1-1/8	1-5/16	1-1/2	2-1/4	032806ABLK*	7.0
1-1/2	1-7/8	1-7/8	3	0328008BLK*	16.0

* OEM Bulk Pkg. - 50 Pcs.

Spare Flanged Nut See Fig. 0326 on Page 161.



Fig. 0328
Black

Fig. 0328
White

**NOTE: Thru-Hull Connections For Use With Hose Are Not Recommended For Use Below The Waterline Per A.B.Y.C. "Safety Standards For Small Craft" Section H-27.



Fig. 0377 - Thru-Hull Scupper For Use with Hose

CONSTRUCTION:

- Cast Bronze
- Plain or Chrome Plated
- Recessed Flapper
- “B” Style for greater hull thickness

Flange is Machined to Fit Hull and Grooved to Retain Bedding Compound

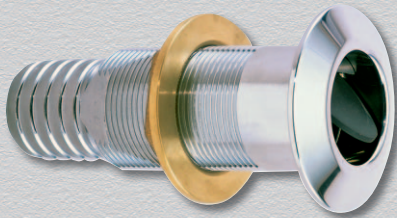

Fig. 0377B CHR

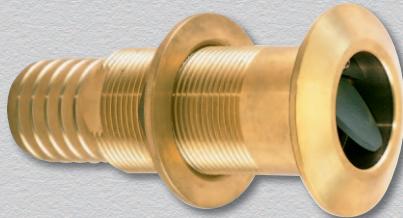

Fig. 0377B PLB

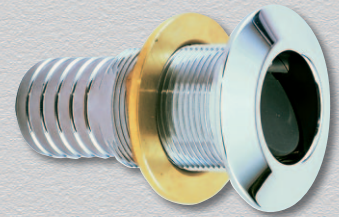

Fig. 0377A CHR

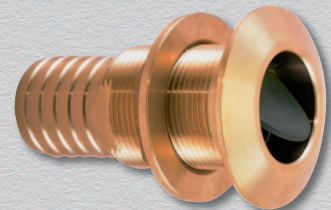

Fig. 0377A PLB



Illustration Of Bedding Groove

ORDERING & TECH INFO

Finish	Hose Size Inches	Mounting Hole Dia. Inches	Maximum Hull Thickness Inches	O.D. Flange Inches	OEM Bulk Pkg.	Ship Wt.
					10 Pcs.	Carton Lbs. OEM Bulk Pkg.
Chrome	1-1/2	1-7/8	1-3/4	3-1/8	0377A08CHR	16.1
Plain	1-1/2	1-7/8	1-3/4	3-1/8	0377A08PLB	16.4
Chrome	2	2-3/8	2	3-3/4	0377A09CHR	22.1
Chrome	1-1/2	1-7/8	3	3-1/8	0377B08CHR	19.4
Plain	1-1/2	1-7/8	3	3-1/8	0377B08PLB	19.4

Spare Flanged Nut See Fig. 0075, on page 161

NOTE: Thru-Hull Connections For Use With Hose Are Not Recommended For Use Below The Waterline Per A.B.Y.C. “Safety Standards For Small Craft” Section H-27.

Fig. 0361 - Flush Mount Drain For Use with Pipe

CONSTRUCTION:

- Chrome Plated Cast Bronze Body with Brass Screen

The exterior surface of the flange is machined flat and designed to be countersunk into the hull, resulting in a smooth external fit.

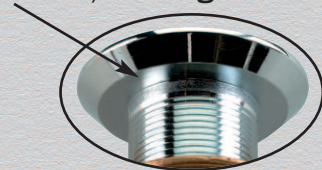

Fig. 0361

ORDERING & TECH INFO

Pipe Size Inches	Mounting Hole Dia. Inches	Maximum Thickness Inches	O.D. Flange Inches	Standard Pkg. - 1 Pc.	OEM Bulk Pkg.	Ship Wt. Carton Lbs.
						Std. Pkg./OEM Bulk
3/4	1	2-3/8	2	0361005CHR	10	0.8/6.1
1-1/4	1-5/8	2-15/16	2-7/8	0361007CHR	10	1.4/10.7

Spare Flanged Nut See Fig. 0075, on page 161.



Fig. 0323

Fig. 0323 - Thru-Hull Scupper For Mounting Through Transom

CONSTRUCTION:

- Molded White Polymer
- Soft Black Flapper
- Nut and Mounting Hardware Included

ORDERING & TECH INFO

Hose Size Inches	Mounting Hole Dia. Inches	Max. Hull Thickness Inches	O.D. Flange Inches	Dealer Pkg. 5 Cards 1 Pc. per Card	OEM Bulk Pkg. 50 Pcs.	Ship Wt. Carton Lbs. DP/OEM Bulk
1-1/2	1-7/8	2-1/8	2-7/8	0323DP	0323	2.9/17.0

Spare Flanged Nut See Fig. 0326, on page 161. Spare Flapper: 0323DP099A



Fig. 0327

Fig. 0327 - Thru-Hull Scupper For Mounting Through Transom

CONSTRUCTION:

- Molded White Polymer
- Recessed Soft Black Flapper
- Nut and Mounting Hardware Included

ORDERING & TECH INFO

Hose Size Inches	Mounting Hole Dia. Inches	Max. Hull Thickness Inches	O.D. Flange Inches	OEM Bulk Pkg. 50 Pcs.	Ship Wt. Carton Lbs. OEM Bulk Pkg.
1-1/2	1-7/8	3-1/4	2-7/8	0327	18.5

Spare Flanged Nut See Fig. 0326, on page 161. Spare Flapper: 0323DP099A

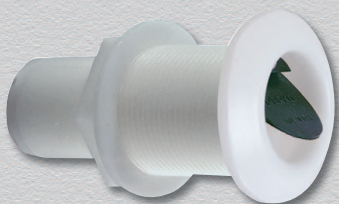

Fig. 0333

Fig. 0333 - Thru-Hull Scupper For Mounting Through Transom

CONSTRUCTION:

- Molded White Polymer
- Recessed Soft Black Flapper
- Nut Included

ORDERING & TECH INFO

Hose Size Inches	Mounting Hole Dia. Inches	Max. Hull Thickness Inches	O.D. Flange Inches	Dealer Pkg. 5 Cards 1 Pc. per Card	OEM Bulk Pkg. 50 Pcs.	Ship Wt. Carton Lbs. DP/OEM Bulk
1-1/2	1-7/8	2-1/8	3	0333DP	0333	2.0/15.0

Spare Flanged Nut See Fig. 0326, on page 161. Spare Flapper: 0333DP099A

Fig. 0343

Fig. 0343 - Adjustable Thru-Hull Scupper

CONSTRUCTION:

- Molded White Polymer
- Recessed Soft Black Flapper

Designed for Surface Thickness from 2 inches to 4-3/4 inches. Female portion of scupper can be cut down by one rib for each 1/4 inch difference between hull thickness and 4-3/4 inches.

ORDERING & TECH INFO

I.D. Inches	Mounting Hole Dia. Inches	Max. Hull Thickness Inches	O.D. Flange Inches	Dealer Pkg. 5 Cards 1 Pc. per Card	OEM Bulk Pkg. 50 Pcs.	Ship Wt. Carton Lbs. DP/OEM Bulk
1-11/32	1-13/16	4-3/4	2-15/16	0343DP	0343	2.5/12.9

Spare Flapper: 0333DP099A

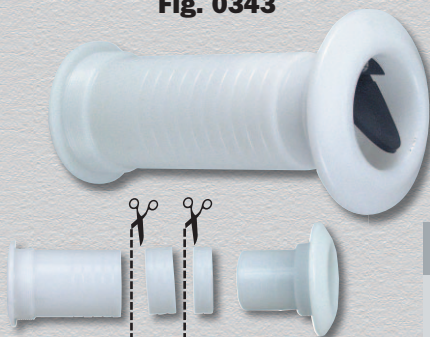

Illustration shows sections of ribs cut out to adjust for various surface thicknesses.

NOTE: The Above Thru-Hull Connections For Use With Hose Are Not Recommended For Use Below The Waterline Per A.B.Y.C. "Safety Standards For Small Craft" Section H-27.

SCUPPERS AND SPARE FLANGED NUTS

Fig. 0142 - Cockpit Scupper

For Use When Discharge is Below the Waterline

CONSTRUCTION:

- Plain or Chrome Plated Cast Bronze
- Rubber Check Ball
- Deck Key Included
- Angle of Outlet is 45 Degrees

ORDERING & TECH INFO

Hose Size Inches	O.D. Grate Inches	O.D. Flange Inches	Plain Bronze Std. Pkg. - 1 Pc.	Chrome Plated Bronze Std. Pkg. - 1 Pc.	Screw Size	Ship Wt. Carton Lbs. PLB/CHR
1	1-13/16	3-1/4	0142001PLB	0142001CHR	8	1.6/1.6
1-1/2	2-1/4	3-5/8	0142002PLB	0142002CHR*	8	2.4/2.4

* O.E.M. Bulk Pkg. Available - 10 pcs.

SPARE PARTS ORDERING INFORMATION

Hose Size Inches	Plain Bronze	Chrome Plated Bronze	Check Ball Only	Spare Key Only
1	0142P0199A	0142C0199A	014200199B	12487-8DP
1-1/2	0142P0299A	0142C0299A	014200299B	12487-8DP



Fig. 0142

6

Fig. 0285 - Flush Mount Cockpit Scupper For Use with Hose

For Use When Discharge is Above the Waterline

CONSTRUCTION:

- Molded White Polymer

Insert Prevents Passage of Large Objects Without Restricting Water Flow

ORDERING & TECH INFO

Hose Size Inches	Max. Hull Thickness Inches	O.D. Flange Inches	I.D. Inches	Dealer Pkg. 5 Cards 1 Pc. per Card	OEM Bulk Pkg. 50 Pcs.	Ship Wt. Carton Lbs. DP/OEM Bulk
1-1/2	1-3/4	2-3/4	1-1/2	0285DP	0285	2.0/15.4

Spare Flanged Nut See Fig. 0326, Below



Fig. 0285

Fig. 0365 - Scupper Valve Assembly for Surface Mount Applications

CONSTRUCTION:

- Molded White Polymer
- Soft Black Flapper

Thru-Hull and Mounting Hardware not Included

ORDERING & TECH INFO

O.D. Flange Inches	Dealer Pkg. - 5 Cards 1 Pc. per Card	OEM Bulk Pkg. 50 Pcs.	Screw Size	Ship Wt. Carton Lbs. DP/OEM Bulk
2-7/8	0365DP	0365	6	0.7/3.4



Fig. 0365

Fig. 0075 - Spare Flanged Lock Nut

- Cast Bronze

Fig. 0326 - Spare Flanged Lock Nut

- Molded White or Black Polymer



ORDERING & TECH INFO

Pipe Size Inches	Cast Bronze Nut	Dealer Pkg. Pcs.	Ship Wt. Carton Lbs. Dealer Pkg.	Wht Polymer Dealer Pkg. 10 Pcs.	Wht Polymer OEM Bulk Pkg.	Blk Polymer OEM Bulk Pkg.	Bulk Pkg. Qty.	Ship Wt. Carton Lbs. DP/OEM Bulk
3/8	0075003DPP	5	0.3	—	—	—	—	—
1/2	0075004DPP	5	0.3	0326DP4	0326004	0326004BLK	100	0.4/1.0
3/4	0075005DPP	5	0.5	0326DP5	0326005	0326005BLK	100	0.4/1.5
1	0075006DPP	5	0.6	0326DP6	0326006	0326006BLK	50	0.4/1.0
1-1/4	0075007DPP	5	0.8	—	—	—	—	—
1-1/2	0075008DPP	1	0.4	0326DP8	0326008	0326008BLK	50	0.8/1.5
2	0075009DPP	1	0.4	—	—	—	—	—
2-1/2	0075010DPP	1	0.6	—	—	—	—	—
3	0075011DPP	1	1.0	—	—	—	—	—

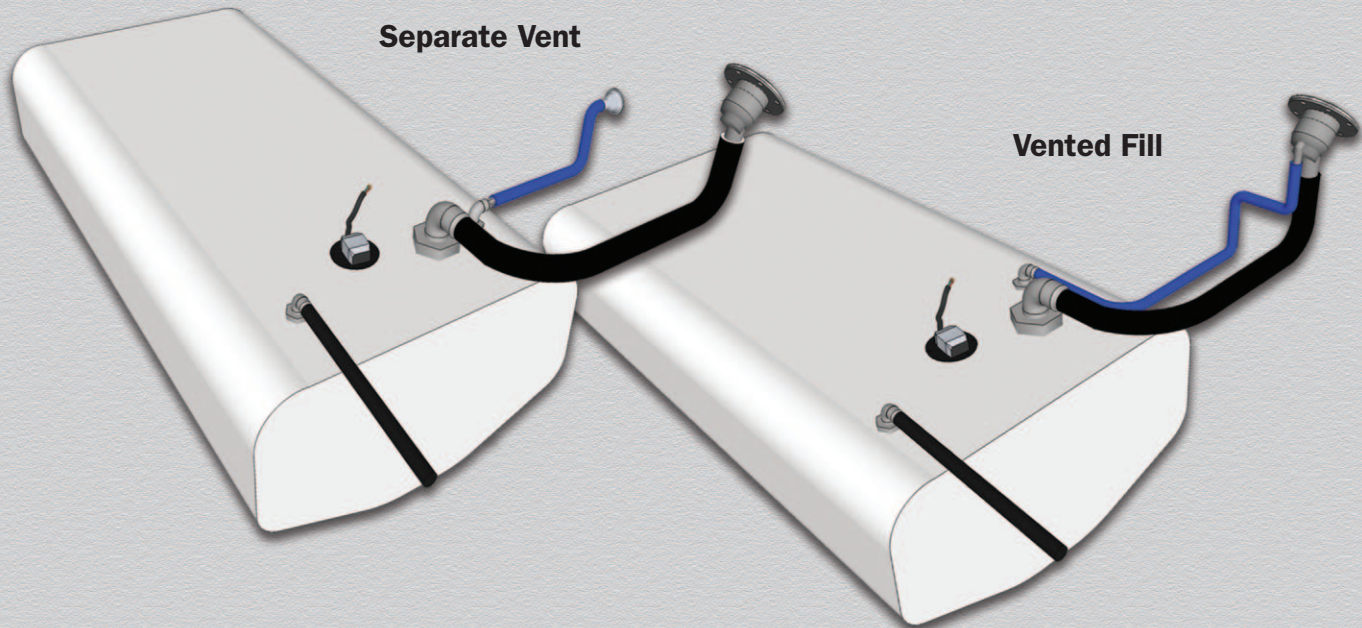

Fig. 0075



Fig. 0326 White Fig. 0326 Black

7



Today's fuel systems use simple components and vent tanks to the atmosphere allowing hydrocarbons to escape. These systems rely on users to determine when a tank is properly filled with fuel and shut off the pump. Overfilling can result in fuel spills while towing or storing at odd angles or on hot days.

The fuel system components of *TODAY*



See PERKO® Fuel System Catalog for product details or visit www.perkofuelsystems.com for information online

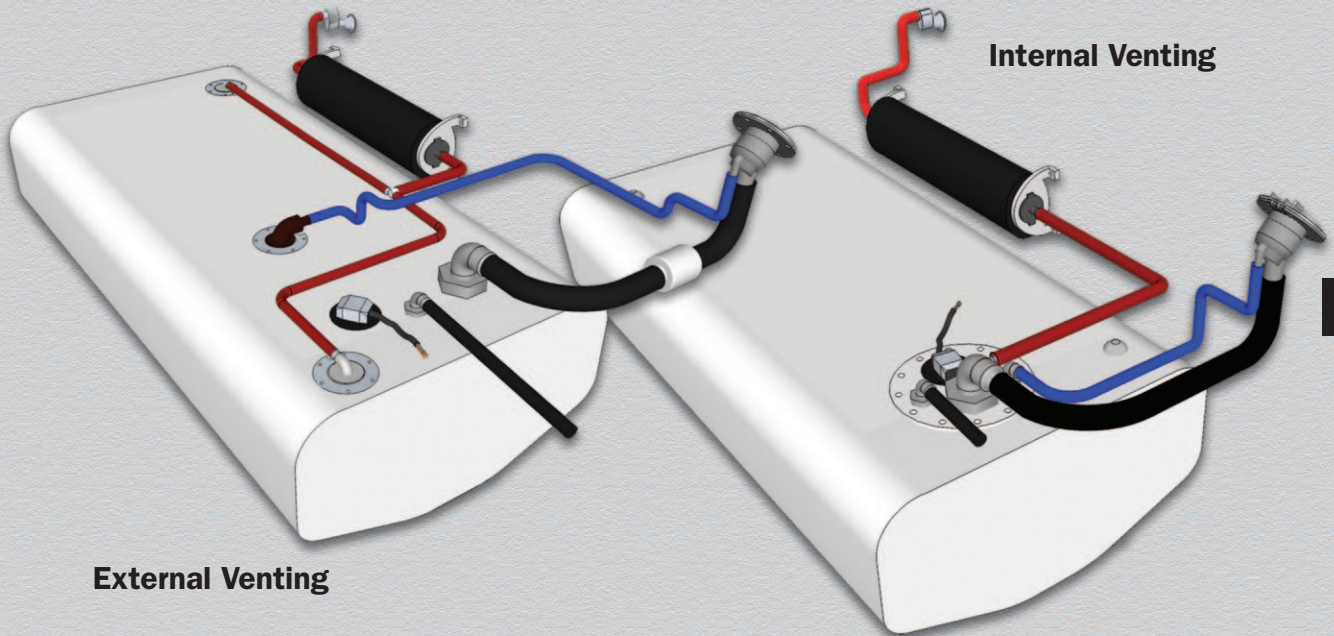

External Venting

Internal Venting

7

EPA and CARB regulations will affect fuel system designs beginning in 2011. Much like automotive systems, many of these new systems will automatically shut off fuel pumps when tanks are full and vent through carbon canisters to reduce the level of hydrocarbons escaping into the atmosphere.

The fuel system components of TOMORROW



Carbon Canisters



Sealed Fuel Fills



P-Traps



Tank Vents

See PERKO® Fuel System Catalog for product details or visit www.perkofuelsystems.com for information online

AVAILABLE CONFIGURATIONS FOR FILL SETS

Fill & Vent Sets



0580 Style
1-1/2" Fills for Hose
 Vented & Non-Vented
 Angled & Straight
 Gas, Diesel, Water & Waste



0582 Style
1-1/2" Fills for Hose
 Vented & Non-Vented
 Angled & Straight
 Gas, Diesel, Water & Waste



0540 Style
1-1/2" Fills for Hose
 Vented & Non-Vented
 Angled & Straight
 Gas, Diesel, Water & Waste

2" Fills for Hose
 Vented & Non-Vented
 Angled & Straight
 Gas, Diesel, Water & Waste



0590 Style
1-1/2" Fills for Hose
 Vented & Non-Vented
 Angled & Straight
 Gas, Diesel, Water & Waste

2" Fills for Hose
 Vented & Non-Vented
 Angled & Straight
 Gas & Diesel



0542 Style
1-1/2" Fills for Hose
 Vented & Non-Vented
 Angled & Straight
 Gas, Diesel & Water
 Black or White Polymer



1319 Style
1-1/2" Fills for Hose
 Vented
 Angled & Straight
 Gas & Water
 Black or White Polymer

Non-Vented Fill Sets



0520, 0524 & 0528 Style
1-1/2" Fills for Hose
 or
1-1/2" & 2" Pipe
 Non-Vented, Straight
 Gas, Diesel, Water & Waste
 Plain Un-Marked
Fills for Pipe
 1" to 3"



1270 Style
1-1/2" Fills for Hose
 Non-Vented
 Straight
 Gas, Diesel, Water &
 Waste

Fig. 0540 Ring - Spare Mounting Ring

Installation Note: on the use of Vented Fuel Fills

PERKO® Fig. Nos. 0540, 0541, 0542, 0543, 0580, 0581, 0582, 0583, 0590 & 0591

The use of these heightening rings is required in any application where water might be splashed around a vented fill. The ring raises the opening between the fuel cap and fill an additional 3/8" above the deck surface thereby reducing the likelihood that splashed water will enter the fuel system through the breathing vent. The split version of the ring is designed for aftermarket use on existing installations. In most cases it allows the ring to be added without disconnecting fuel and vent hoses from the fill. For new OEM installations, rings are supplied without the split since they can then be installed before hoses are connected to the fill.

NOTE: The ring will not prevent water from entering the system if the cap becomes submerged or substantially flooded. If this situation exists, the fill/vent must be moved to a dry location or replaced with a sealed cap and a separate vent located elsewhere.

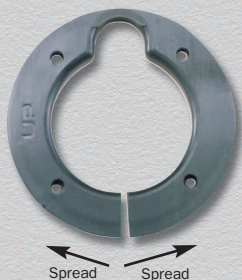

Fig. 0540DPR

ORDERING INFO

Dealer Pkg. - 5 Cards
1 Pc. Per Card
 0540DPRBLK

OEM Bulk Pkg.
50 Pcs.
 0540RNGBLK

PERKO® VENTED FILLS

Figs. 0540 & 0541 - Vented Fills For 1-1/2" Hose

Patent Nos. 5,275,213 & 5,327,946

CONSTRUCTION:

- Chrome Plated Bronze Cap
- Black Polymer Body
- Stainless Steel Bead Chain
- Integral Tank Vent with Flame Arrestor and Anti Surge Valve
- Deck Plate Key Included

Fig. 0540 - Angled Neck

Fig. 0541 - Straight Neck



Fig. 0541 Diesel



Fig. 0540 Gas Shown with Marinum Cap

CE **MARINUM**
Contact Factory

ORDERING INFO				
Marked For	Neck	Dealer Pkg. 5 Pcs.	OEM Bulk Pkg. 25 Pcs.	Ship Wt. Carton Lbs. DP/OEM Bulk
Gas	Angled	0540DPGCHR*	0540G00CHR*	4.2/15.7
Diesel	Angled	0540DPDCHR	0540D00CHR	4.2/15.1
Water	Angled	0540DPWCHR	0540W00CHR	4.2/15.1
Gas	Straight	0541DPGCHR*	0541G00CHR*	4.1/15.2
Diesel	Straight	0541DPDCHR	0541D00CHR	4.1/15.0
Water	Straight	0541DPWCHR	0541W00CHR	4.1/14.9

TECH INFO
For Hose Size: 1-1/2" For Vent Hose: 5/8" Neck Length: 2-7/16" Screw Size: #8

STOP FUEL THEFT
 Fig. 0525 Locking Insert See Page 178

SPARE PARTS ORDERING INFORMATION

Gas Cap, O-Ring & Retainer: 0540DPG99A
 Diesel Cap, O-Ring & Retainer: 0540DPD99A
 Water Cap, O-Ring & Retainer: 0540DPW99A
 Deck Plate Key: 1247DP0BLK
 O-Ring Only: 054000099B



Fig. 1247

For a Matching Waste Deck Plate Please see Fig. 0556 on Page 176.

Note: Consider the use of the Mounting Ring (Fig. 0540DPRBLK) on page 164 for all installations. Dealer Package includes mounting ring.

Figs. 0590 & 0591 - Vented Fills For 1-1/2" Hose

Patent Nos. 5,275,213 & 5,327,946

CONSTRUCTION:

- Chrome Plated Bronze Cap
- Black Polymer Body
- Stainless Steel Bead Chain
- Integral Tank Vent with Flame Arrestor and Anti Surge Valve
- Deck Plate Key Not Required

Fig. 0590 - Angled Neck

Fig. 0591 - Straight Neck



Fig. 0591 Diesel



Fig. 0590 Gas



ORDERING INFO				
Marked For	Neck	Dealer Pkg. 5 Pcs.	OEM Bulk Pkg. 25 Pcs.	Ship Wt. Carton Lbs. DP/OEM Bulk
Gas	Angled	0590DPGCHR*	0590G00CHR*	5.0/18.9
Diesel	Angled	0590DPDCHR	0590D00CHR	5.0/18.9
Water	Angled	0590DPWCHR	0590W00CHR	5.0/18.7
Gas	Straight	0591DPGCHR*	0591G00CHR*	5.0/18.6
Diesel	Straight	0591DPDCHR	0591D00CHR	5.0/18.1
Water	Straight	0591DPWCHR	0591W00CHR	5.0/17.5

TECH INFO
For Hose Size: 1-1/2" For Vent Hose: 5/8" Neck Length: 2-7/16" Screw Size: #8

STOP FUEL THEFT
 Fig. 0525 Locking Insert See Page 178

SPARE PARTS ORDERING INFORMATION

Gas Cap, O-Ring & Retainer: 0590DPG99A
 Diesel Cap, O-Ring & Retainer: 0590DPD99A
 Water Cap, O-Ring & Retainer: 0590DPW99A
 O-Ring Only: 054000099B

For a Matching Waste Deck Plate Please see Fig. 0563 on Page 176.

Note: Consider the use of the Mounting Ring (Fig. 0540DPRBLK) on page 164 for all installations. Dealer Package includes mounting ring.

*NOTE: These Items Meet the Requirements of U.S.C.G. Safety Standards, January 31, 1977, for Gasoline Fuel Systems, 33 CFR 183. Fills shown on this page DO NOT meet the requirements for 40 CFR 1060 sub part B Emissions Standards and Related Requirements.

VENTED FILLS



Figs. 0542 & 0543 - Vented Fills For 1-1/2" Hose

Patent Nos. 5,275,213 & 5,327,946

Fig. 0543
Water

CONSTRUCTION:

- Black or White Polymer Cap with Black Polymer Body
- Polymer Strap
- Integral Tank Vent with Flame Arrestor and Anti Surge Valve
- Deck Plate Key Included



Fig. 0542
Gas



Fig. 0542 Gas
White Top



Fig. 0543 Gas
White Top

Fig. 0542 - Angled Neck
Fig. 0543 - Straight Neck

7

Note: Consider the use of the Mounting Ring (Fig. 0540DPRBLK) on page 164 for all installations. (Included in Dealer Pkg.)



Fig. 0540DPR

ORDERING INFO

Marked For	Cap Color	Dealer Pkg. 5 Pcs.	OEM Bulk Pkg. 25 Pcs.	Ship Wt.
				Carton Lbs. DP/OEM Bulk
ANGLED NECK				
Gas	Black	0542DPGBLK*	0542G00BLK*	3.0/9.2
Gas	White	0542DPGWHT*	0542G00WHT*	3.0/9.2
Water	Black	0542DPWBLK	0542W00BLK	3.0/9.2
STRAIGHT NECK				
Gas	Black	0543DPGBLK*	0543G00BLK*	3.0/9.2
Gas	White	0543DPGWHT*	0543G00WHT*	3.0/9.2
Water	Black	0543DPWBLK	0543W00BLK	3.0/9.2

TECH INFO

For Hose Size: 1-1/2"
For Vent Hose: 5/8"
Neck Length: 2-7/16"
Screw Size: #8



Fig. 1247

SPARE PARTS ORDERING INFORMATION

Black Gas Cap, O-Ring & Retainer: 0542DPG99B White Gas Cap, O-Ring & Retainer: 0542DPW99B
Black Water Cap, O-Ring & Retainer: 0542DPW99B White Water Cap, O-Ring & Retainer: 0542DPW99W
O-Ring Only: 054000099B

ALSO AVAILABLE IN
MARINIUM
Contact Factory

Fig. 0577 - Vented Fuel Fill for 2 Inch Hose

Patent No. 5,275,213



Fig. 0577



Fig. 1247

CONSTRUCTION:

- Chrome Plated Bronze
- Integral Tank Vent with Flame Arrestor
- Deck Plate Key, O-Ring and Integral Retainer on Cap Included
- Ground Wire Required



Alternative Style Cap Available. Contact Factory.

ORDERING INFO

Marked For:	OEM Bulk Pkg. 5 Pcs.	Ship Wt. Carton Lbs.
	Std. Pkg. - 1 Pc.	Std Pkg/OEM Bulk
Gas	0577G00CHR*	2.0/19.5
Diesel	0577D00CHR	2.0/19.5

TECH INFO

For Fuel Hose: 2"
For Vent Hose: 5/8"
Neck Length: 3-5/8"
Screw Size: #8

*NOTE: These Items Meet the Requirements of U.S.C.G. Safety Standards, January 31, 1977, for Gasoline Fuel Systems, 33 CFR 183. Fills shown on this page DO NOT meet the requirements for 40 CFR 1060 sub part B Emissions Standards and Related Requirements.

PERKO® VENTED FILLS



Figs. 1318 & 1319 - Vented Fills For 1-1/2" Hose

Patent No. 5,275,213

CONSTRUCTION:

- Black or White Polymer
- Integral Tank Vent with Flame Arrestor
- No Deck Plate Key or Ground Wire Required
- Flip Top Cap

Fig. 1318 - 35° Angled Neck
Fig. 1319 - Straight Neck



7

STOP FUEL THEFT



Fig. 0525
 Locking Insert
 See Page 178

ORDERING INFO

Marked For	Dealer Pkg. 10 Cards 1 Pc. per Card	OEM Bulk Pkg. 50 Pcs.	Ship Wt. Carton Lbs. DP/OEM Bulk
Gas	1318DPGBLK*	1318G00BLK*	5.5/17.8
Gas	1319DPGBLK*	1319G00BLK*	4.7/13.5
Gas	1319DPGWHT*	1319G00WHT*	4.7/14.1
Water	1319DPWBLK	1319W00BLK	4.7/14.0
Water	1319DPWWHT	1319W00WHT	4.7/13.9

TECH INFO

For Hose Size: 1-1/2"
 For Vent Hose: 5/8"
 Neck Length: 2-7/16"
 Screw Size: #10

Fig. 0579 - Angled Vented Fuel Fill for 2 Inch Hose

Patent No. 5,275,213

Construction:

- Chrome Plated Bronze
- Integral Tank Vent with Flame Arrestor
- Angled Neck
- Deck Plate Key, O-Ring and Integral Retainer on Cap Included
- Ground Wire Required

ALSO AVAILABLE IN
MARINIUM®
 Contact Factory



Fig. 1247



Alternative Style Cap Available. Contact Factory.

Fig. 0579

ORDERING INFO

Marked For	Std. Pkg. - 1 Pc.	Ship Wt. Carton Lbs. Std. Pkg.
Gas	0579G00CHR*	2.5
Diesel	0579D00CHR	2.4

TECH INFO

For Fuel Hose: 2"
 For Vent Hose: 5/8"
 Neck Length: 4-3/4"
 Screw Size: #8

*NOTE: These Items Meet the Requirements of U.S.C.G. Safety Standards, January 31, 1977, for Gasoline Fuel Systems, 33 CFR 183. Fills shown on this page DO NOT meet the requirements for 40 CFR 1060 sub part B Emissions Standards and Related Requirements.

OEM BULK PACKED COLOR CODED VENTED FILLS WITH METALLIC INSERTS



Figs. 0580 & 0581 - OEM Bulk Packaged Vented Fills For 1-1/2" Hose With Color Coded Metallic Insert for Gas, Diesel or Water

Patent Nos. 5,275,213 & 5,327,946

CONSTRUCTION:

- Chrome Plated Bronze or Stainless Steel Scalloped Cap
- Color Coded Metallic Insert
 - Black Polymer Body
 - Polymer Tether
- Integral Tank Vent with Flame Arrestor and Anti Surge Valve
- Deck Plate Key Included

Fig. 0580 - Angled Neck
Fig. 0581 - Straight Neck

Fig. 0580
Gas



Fig. 0581
Diesel



Fig. 0580
Water



Color Coded Metallic Inserts



ORDERING INFO					
Marked For	Cap Type	Neck	OEM Bulk Pkg. 25 Pcs.	Ship Wt. Carton	Lbs. OEM Bulk
Gas	Chrome	Angled	0580G00CHR*		17.2
Diesel	Chrome	Angled	0580D00CHR		17.2
Water	Chrome	Angled	0580W00CHR		17.2
Gas	Stainless	Angled	0580G00STS*		15.8
Diesel	Stainless	Angled	0580D00STS		15.8
Water	Stainless	Angled	0580W00STS		15.8
Gas	Chrome	Straight	0581G00CHR*		17.2
Diesel	Chrome	Straight	0581D00CHR		17.2
Water	Chrome	Straight	0581W00CHR		17.2
Gas	Stainless	Straight	0581G00STS*		15.8
Diesel	Stainless	Straight	0581D00STS		15.8
Water	Stainless	Straight	0581W00STS		15.8

TECH INFO

For Hose Size: 1-1/2"
For Vent Hose: 5/8"
Neck Length: 2-7/16"
Screw Size: #8

**For Matching Waste
Deck Plate See
Fig. 0568 on Page 176**

STOP FUEL THEFT



Fig. 0525
Locking Insert
See Page 178

SPARE PARTS ORDERING INFORMATION		
Description	Dealer Pkg. - 5 Pcs.	
Metallic Insert Kit	0030DP0005	(includes 4 inserts)
Deck Plate Key	1241DP0BLK	

Note: Consider the use of the Mounting Ring (Fig. 0540DPRBLK) on page 164 for all installations. (Included in Dealer Pkg.)



Fig. 1241

*NOTE: These Items Meet the Requirements of U.S.C.G. Safety Standards, January 31, 1977, for Gasoline Fuel Systems, 33 CFR 183. Fills shown on this page DO NOT meet the requirements for 40 CFR 1060 sub part B Emissions Standards and Related Requirements.

OEM BULK PACKED COLOR CODED VENTED FILLS WITH RESIN INSERTS



Figs. 0582 & 0583 - OEM Bulk Packaged Vented Fills For 1-1/2" Hose With Color Coded Resin Insert for Gas, Diesel or Water

Patent Nos. 5,275,213 & 5,327,946

CONSTRUCTION:

- Chrome Plated Bronze or Stainless Steel Scalloped Cap
- Color Coded Resin Insert
- Black Polymer Body
- Polymer Tether
- Integral Tank Vent with Flame Arrestor and Anti Surge Valve
- Deck Plate Key Included

Fig. 0583
Water



Fig. 0582 - Angled Neck
Fig. 0583 - Straight Neck



Fig. 0582
Gas



Fig. 0582
Diesel



7

ORDERING INFO

Marked For	Cap Type	Neck	OEM Bulk Pkg. 25 Pcs.	Ship Wt. Carton Lbs. OEM Bulk
Gas	Chrome	Angled	0582G00CHR*	17.2
Diesel	Chrome	Angled	0582D00CHR	17.2
Water	Chrome	Angled	0582W00CHR	17.2
Gas	Stainless	Angled	0582G00STS*	15.8
Diesel	Stainless	Angled	0582D00STS	15.8
Water	Stainless	Angled	0582W00STS	15.8
Gas	Chrome	Straight	0583G00CHR*	17.2
Diesel	Chrome	Straight	0583D00CHR	17.2
Water	Chrome	Straight	0583W00CHR	17.2
Gas	Stainless	Straight	0583G00STS*	15.8
Diesel	Stainless	Straight	0583D00STS	15.8
Water	Stainless	Straight	0583W00STS	15.8

TECH INFO

For Hose Size: 1-1/2"
For Vent Hose: 5/8"
Neck Length: 2-7/16"
Screw Size: #8

For Matching Waste Deck Plate See Fig. 0569 on Page 176

STOP FUEL THEFT



Fig. 0525
Locking Insert
See Page 178

Color Coded Resin Inserts



SPARE PARTS ORDERING INFORMATION

Cap, O-Ring & Retainer: 0582DPC99A
(Includes 3 Resin inserts; Gas, Diesel & Water)
Resin Insert Kit: 0030DP0004 (includes 4 inserts)
Deck Plate Key: 1241DP0BLK.

Note: Consider the use of the Mounting Ring (Fig. 0540DPRBLK) on page 164 for all installations. (Included in Dealer Pkg.)



Fig. 1241



*NOTE: These Items Meet the Requirements of U.S.C.G. Safety Standards, January 31, 1977, for Gasoline Fuel Systems, 33 CFR 183. Fills shown on this page DO NOT meet the requirements for 40 CFR 1060 sub part B Emissions Standards and Related Requirements.

OEM BULK PACKED COLOR CODED FILLS

Fig. 0551 - OEM Bulk Packaged Fuel & Water Fills for 1-1/2" Hose With Color Coded Metallic Insert for Gas, Diesel or Water



Fig. 0551



CONSTRUCTION:

- Chrome Plated Bronze or Stainless Steel Scalloped Cap
 - Color Coded Metallic Insert for Gas, Diesel or Water
 - Black Polymer Body
- Deck Plate Key Included

ORDERING INFO

Marked For	Cap Type	OEM Bulk Pkg. 25 Pcs.	Ship Wt. Carton Lbs. OEM Bulk
Gas	Chrome	0551G00CHR*	20.5
Diesel	Chrome	0551D00CHR	20.5
Water	Chrome	0551W00CHR	20.5
Gas	Stainless	0551G00STS*	18.0
Diesel	Stainless	0551D00STS	18.0
Water	Stainless	0551W00STS	18.0

TECH INFO

For Hose Size: 1-1/2"
 Neck Length: 3-1/8"
 Mounting Hole
 Dia.: 2-1/8"
 Screw Size: #8



Fig. 1241

For Matching Waste Deck Plate See Fig. 0568 on Page 176.

COLOR CODED METALLIC INSERTS



SPARE PARTS ORDERING INFORMATION

Description	Dealer Pkg. - 5 Pcs.
Metallic Insert Kit	0030DP0005 (includes 4 inserts)
Deck Plate Key	1241DP0BLK

Fig. 0552 - OEM Bulk Packaged Fuel & Water Fills for 1-1/2" Hose With Color Coded Resin Insert for Gas, Diesel or Water



Fig. 0552



CONSTRUCTION:

- Chrome Plated Bronze or Stainless Steel Scalloped Cap
 - Color Coded Resin Insert
 - Black Polymer Body
- Deck Plate Key Included

ORDERING INFO

Marked For	Cap Type	OEM Bulk Pkg. 25 Pcs.	Ship Wt. Carton Lbs. OEM Bulk
Gas	Chrome	0552G00CHR*	19.8
Diesel	Chrome	0552D00CHR	19.8
Water	Chrome	0552W00CHR	19.8
Gas	Stainless	0552G00STS*	18.5
Diesel	Stainless	0552D00STS	18.5
Water	Stainless	0552W00STS	18.5

TECH INFO

For Hose Size: 1-1/2"
 Neck Length: 3-1/8"
 Mounting Hole
 Dia.: 2-1/8"
 Screw Size: #8



Fig. 1241

For Matching Waste Deck Plate See Fig. 0569 on Page 176

COLOR CODED RESIN INSERTS



SPARE PARTS ORDERING INFORMATION

Description	Dealer Pkg. - 5 Pcs.
Resin Insert Kit	0030DP0004 (includes 4 inserts)
Deck Plate Key	1241DP0BLK

*NOTE: These Items Meet the Requirements of U.S.C.G. Safety Standards, January 31, 1977, for Gasoline Fuel Systems, 33 CFR 183. Fills shown on this page DO NOT meet the requirements for 40 CFR 1060 sub part B Emissions Standards and Related Requirements.

RETAIL PACKAGED COLOR CODED FILLS



Figs. 0582 & 0583 - Retail Packaged Vented Fills For 1-1/2" Hose With Color Coded Resin Inserts for Gas, Diesel or Water

Patent Nos. 5,275,213 & 5,327,946

CONSTRUCTION:

- Chrome Plated Bronze Scalloped Cap
- Color Coded Resin Inserts
- Includes 3 Resin Inserts, 1 each Gas, Diesel & Water
- Black Polymer Body
- Integral Tank Vent with Flame Arrestor and Anti Surge Valve
- Deck Plate Key and Mounting Ring Included

Fig. 0582 - Angled Neck with Polymer Tether

Fig. 0583 - Straight Neck with Polymer Tether

Fig. 0583



Fig. 0582



7

ORDERING INFO		
	Dealer Pkg. 5 Pcs.	Ship Wt. Carton Lbs. OEM Bulk
Neck Type		
Angled	0582DPOCHR	4.5
Straight	0583DPOCHR	4.5

TECH INFO
For Fuel Hose: 1-1/2"
For Vent Hose: 5/8"
Neck Length: 2-7/16"
Screw Size: #8

SPARE PARTS ORDERING INFORMATION		
Description	Dealer Pkg. - 5 Pcs.	
Spare Cap (Vented)	0582DPC99A	(includes 3 inserts)
Resin Insert Kit	0030DP0004	(includes 4 inserts)
Deck Plate Key	1241DPOBLK	

For Matching Waste Deck Plate
Please See Fig. 0552 Below

STOP FUEL THEFT



Fig. 0525
Locking Insert
See Page 178



Dealer Pack



Fig. 0582 Spare Cap with 3 Inserts

Fig. 0540DPRBLK
Mounting Ring Included
See Page 164



Fig. 1241

Fig. 0552 - Retail Packaged Fill for 1-1/2" Hose With Color Coded Resin Inserts for Gas, Diesel, Water & Waste



Construction:

- Chrome Plated Bronze Scalloped Cap
- Color Coded Resin Inserts
- Includes 4 Resin Inserts, 1 each Gas, Diesel, Water & Waste
- Black Polymer Body
- Deck Plate Key Included



Fig. 0552
Spare Cap
with 4 Inserts



Fig. 0552

ORDERING INFO		
	Dealer Pkg. 5 Pcs.	Ship Wt. Carton Lbs. OEM Bulk
Cap Type		
Chrome Bronze	0552DPOCHR	4.9

TECH INFO
For Fuel Hose: 1-1/2"
Neck Length: 3-1/8"
Mounting Hole Dia.: 2-1/8"
Screw Size: #8

SPARE PARTS ORDERING INFORMATION		
Description	Dealer Pkg. - 5 Pcs.	
Spare Cap (Non-Vented)	0552DPC99A	(includes 4 inserts)
Resin Insert Kit	0030DP0004	(includes 4 inserts)
Deck Plate Key	1241DPOBLK	



Fig. 1241



Dealer Pack

*NOTE: These Items Meet the Requirements of U.S.C.G. Safety Standards, January 31, 1977, for Gasoline Fuel Systems, 33 CFR 183. Fills shown on this page DO NOT meet the requirements for 40 CFR 1060 sub part B Emissions Standards and Related Requirements.

FUEL & WATER FILLS FOR HOSE



Fig. 0557



Fig. 1247

Fig. 0557 - Fuel & Water Fills for 1-1/2" Hose

CONSTRUCTION:

- Chrome Plated Bronze Cap & Black Polymer Body
- Deck Plate Key and O-Ring Included

ORDERING INFO			TECH INFO	
Marked For	Dealer Pkg. - 5 Cards 1 Pc. per Card	OEM Bulk Pkg. 25 Pcs.	Ship Wt. Carton Lbs. DP/OEM Bulk	For Hose Size: 1-1/2" O.D. Flange: 3-3/8" Neck Length: 3-1/8" Mounting Hole Dia.: 2-1/8" Screw Size: #8
Gas	0557DPGCHR*	0557G00CHR*	4.0/18.0	
Diesel	0557DPDCHR	0557D00CHR	4.0/18.0	
Water	0557DPWCHR	0557W00CHR	4.0/18.0	

SPARE PARTS ORDERING INFORMATION

Gas Cap with O-Ring: 0540DPG99A Diesel Cap with O-Ring: 0540DPD99A
Water Cap with O-Ring: 0540DPW99A Deck Plate Key: 1247DP0BLK
O-Ring Only: 054000099B

For Matching Waste Deck Plate See Fig. 0556 on Page 176.



Fig. 0564

Fig. 0564 - Fuel & Water Fills for 1-1/2" Hose

CONSTRUCTION:

- Chrome Plated Bronze Cap & Black Polymer Body
- O-Ring Included • No Deck Plate Key Required

ORDERING INFO			TECH INFO	
Marked For	Dealer Pkg. - 5 Cards 1 Pc. per Card	OEM Bulk Pkg. 25 Pcs.	Ship Wt. Carton Lbs. DP/OEM Bulk	For Hose Size: 1-1/2" O.D. Flange: 3-3/8" Neck Length: 3-1/8" Mounting Hole Dia.: 2-1/8" Screw Size: #8
Gas	0564DPGCHR*	0564G00CHR*	5.0/21.0	
Diesel	0564DPDCHR	0564D00CHR	5.0/21.0	
Water	0564DPWCHR	0564W00CHR	5.0/21.0	

SPARE PARTS ORDERING INFORMATION

Gas Cap with O-Ring: 0590DPG99A Diesel Cap with O-Ring: 0590DPD99A
Water Cap with O-Ring: 0590DPW99A O-Ring Only: 054000099B

For Matching Waste Deck Plate See Fig. 0563 on Page 176.



Fig. 0520



Fig. 1248

Fig. 0520 - Fuel & Water Fills for 1-1/2" Hose

CONSTRUCTION:

- Chrome Plated Bronze
- Deck Plate Key, O-Ring and Retainer on Cap Included
- Cap Has A Slot Between the Holes • Ground Wire Required

ORDERING INFO			TECH INFO	
Marked For	Dealer Pkg. - 5 Cards 1 Pc. per Card	OEM Bulk Pkg. 25 Pcs.	Ship Wt. Carton Lbs. DP/OEM Bulk	For Hose Size: 1-1/2" O.D. Flange: 3-1/8" Neck Length: 3-1/2" Mounting Hole Dia.: 2-1/8" Screw Size: #8
Gas	0520DPGCHR*	0520G00CHR*	4.2/19.9	
Diesel	0520DPDCHR	0520D00CHR	4.2/19.9	
Water	0520DPWCHR	0520W00CHR	4.2/19.9	

SPARE PARTS ORDERING INFORMATION

Cap with O-Ring and Retainer: 0520DP099A O-Rings Only (2 per bag): 0520DP099B Deck Plate Key: 12487-8DP.

For Matching Waste Deck Plate See Fig. 0507 on Page 177.



Fig. 0576



Fig. 1247

Fig. 0576 - Fuel Fill for 2" Hose

CONSTRUCTION:

- Chrome Plated Bronze
- Deck Plate Key, O-Ring and Retainer on Cap Included
- Ground Wire Required

ORDERING INFO			TECH INFO	
Marked For	OEM Bulk Pkg. - 10 Pcs. Std. Pkg. 1 Pc.	Ship Wt. Carton Lbs. Std. Pkg./OEM Bulk	For Hose Size: 2" O.D. Flange: 3-3/8" Neck Length: 3-5/8" Mounting Hole Dia.: 2-1/4" Screw Size: #8	
Gas	0576G00CHR*	1.2/10.0		
Diesel	0576D00CHR	1.2/10.0		

SPARE PARTS ORDERING INFORMATION

Gas Cap & O-Ring: 0576DPG99A Diesel Cap & O-Ring: 0576DPD99A
Retaining Ring: 0537DP2 Deck Plate Key: 1247DP0BLK

*NOTE: These Items Meet the Requirements of U.S.C.G. Safety Standards, January 31, 1977, for Gasoline Fuel Systems, 33 CFR 183. Fills shown on this page DO NOT meet the requirements for 40 CFR 1060 sub part B Emissions Standards and Related Requirements.



Fig. 0599 - Gas Fill with Locking Cap for 1-1/2" Hose

Patent No. 3,828,714

Construction:

- Chrome Plated Bronze Flange
- Black Polymer Body
- Black Polymer Cap with Strap
- Grounding Screw Included
- Cap Retainer and Gasket
- Locking Cap Has a Cover for the Key Hole



Fig. 0599

ORDERING INFO

Marked For	Dealer Pkg. 5 Cards 1 Pc. per Card	OEM Bulk Pkg. 25 Pcs.	Ship Wt. Carton Lbs. DP/OEM Bulk
Gas	0599DPGCHR*	0599G00CHR*	3.1/13.5
Diesel	0599DPDCHR	0599D00CHR	3.1/13.5

TECH INFO

For Hose Size: 1-1/2"
O.D. Flange: 3-3/8"
Neck Length: 3-1/8"
Mounting Hole Dia.: 2-1/8"
Screw Size: #8

SPARE PARTS ORDERING INFORMATION

Cap with O-Ring and 2 Keys: 1324DP1BLK.

Figs. 1313 & 1399 - Gas Fills for 1-1/2" Hose

Patent No. 3,828,714

Construction:

- Chrome Plated Zinc Alloy
- Black Polymer Flange
- Black Polymer Cap with Strap
- Grounding Screw Included
- Cap Retainer and Gasket
- Fig. 1399 Locking Cap Has a Cover for the Key Hole



Fig. 1313



Fig. 1399

ORDERING INFO

Marked For	Dealer Pkg. 5 Cards 1 Pc. per Card	OEM Bulk Pkg. 50 Pcs.	Ship Wt. Carton Lbs. DP/OEM Bulk
Gas*	1313DPOCHR	1313000CHR	3.1/24.7
Gas w/Lock*	1399DPOCHR	1399000CHR	3.6/25.6

TECH INFO

For Hose Size: 1-1/2"
O.D. Flange: 3-1/8"
Neck Length: 1-7/8"
Mounting Hole Dia.: 2-1/8"
Screw Size: #6

SPARE PARTS ORDERING INFORMATION

Non-Locking Cap: 0126DPOBLK Locking Cap with 2 Keys: 1324DPOBLK

Fig. 1613 - Polymer Gas Fill for 1-1/2" Hose

Construction:

- Fiber Reinforced, U.V. Stabilized Black Polymer
- No Deck Plate Key or Ground Wire Required
- Easy-Grip Cap
- O-Ring and Cap Retainer Included



Fig. 1613

ORDERING INFO

Dealer Pkg. 5 Cards 1 Pc. per Card	OEM Bulk Pkg. 50 Pcs.	Ship Wt. Lbs. DP/OEM Bulk
1613DPOBLK*	1613000BLK*	2.0/13.9

TECH INFO

For Hose Size: 1-1/2"
O.D. Flange: 3-1/16"
Neck Length: 2-7/16"
Mounting Hole Dia.: 1-3/4"
Screw Size: #8

SPARE PARTS ORDERING INFORMATION

Cap with O-Ring and Retainer: 161300099A O-Rings (2 per bag): 1313DP099A

*NOTE: These Items Meet the Requirements of U.S.C.G. Safety Standards, January 31, 1977, for Gasoline Fuel Systems, 33 CFR 183. Fills shown on this page DO NOT meet the requirements for 40 CFR 1060 sub part B Emissions Standards and Related Requirements.

FILLS FOR HOSE AND RETAINING CABLE



Fig. 0527



Fig. 1247

Fig. 0527 - Gas Fill for 1-1/2" Hose

CONSTRUCTION:

- Chrome Plated Bronze
- 35° Angled Hose Bib
- Deck Plate Key, O-Ring and Retaining Cable on Cap Included
- Cap Has A Slot Between the Holes
- Ground Wire Required

ORDERING INFO			TECH INFO
Marked For Gas	Standard Pkg. - 1 Pc. 0527G08CHR*	Ship Wt. Carton Lbs. Std. Pkg. 2.7	For Hose Size: 1-1/2" O.D. Flange: 3-1/2" Neck Length: 4-7/8" Mounting Hole Dia.: 2-1/4" Screw Size: #10

SPARE PARTS ORDERING INFORMATION

Cap with O-Ring and Retainer: 0528DP899A
O-Rings Only (2 per bag): 0513DP8
Deck Plate Key: 1247DPOBLK

7

Fig. 1270 - Fuel & Water Fills for 1-1/2" Hose



Fig. 1270



Fig. 1248

CONSTRUCTION:

- Chrome Plated Zinc Alloy
- Black Polymer Cap
- Deck Plate Key, O-Ring and Integral Retainer on Cap Included
- Cap Has A Slot Between the Holes
- Ground Wire Required

ORDERING INFO				TECH INFO
Marked For:	Dealer Pkg. 5 Cards 1 Pc. per Card	OEM Bulk Pkg. 25 Pcs.	Ship. Wt. Carton Lbs. DP/OEM Bulk	For Hose Size: 1-1/2" O.D. Flange: 3-1/4" Neck Length: 2-1/2" Mounting Hole Dia.: 2-1/8" Screw Size: #8
Gas	1270DPGCHR*	1270G00CHR*	4.0/18.5	
Diesel	1270DPDCHR	1270D00CHR	4.0/18.5	
Water	1270DPWCHR	1270W00CHR	4.0/18.5	

SPARE PARTS ORDERING INFORMATION

Gas Cap with O-Ring and Retainer: 1270DPG99A
Diesel Cap with O-Ring and Retainer: 1270DPD99A
Water Cap with O-Ring and Retainer: 1270DPW99A
O-Rings Only (2 per bag): 0513DP8
Deck Plate Key: 12487-8DP

Fig. 0537 - Retaining Cable for Deck Plates

CONSTRUCTION:

- Stainless Steel Cable and Fittings
- Stainless Steel Ring and Self Tapping Screw



Fig. 0537

ORDERING & TECH INFO				
Fill Hose Size Inches	Ring Dia. Inches	Length Cable Inches	Dealer Pkg. - 5 Cards 1 Pc. per Card	Ship Wt. Carton Lbs. Dealer Pkg.
1-1/2	1-3/8	7	0537DP	0.4
2	2	7	0537DP2	0.4

*NOTE: These Items Meet the Requirements of U.S.C.G. Safety Standards, January 31, 1977, for Gasoline Fuel Systems, 33 CFR 183. Fills shown on this page DO NOT meet the requirements for 40 CFR 1060 sub part B Emissions Standards and Related Requirements.

FUEL, WATER AND UNMARKED FILLS FOR PIPE

Fig. 0528 - Fuel, Water & Unmarked Fills for Pipe

CONSTRUCTION:

- Cast Bronze
- Plain or Chrome Plated
- 1-1/4 and 1-1/2 Inch Caps Have a Slot Between the Holes
- Deck Plate Key and O-Ring Included
- Sizes 9, 10 & 11 Have 4 Mounting Holes



Fig. 1248

ALSO AVAILABLE IN
MARINIUM
Contact Factory



Fig. 0528 Unmarked
Shown in Marinium



Fig. 0528 Gas



Fig. 0528 Diesel



Fig. 0528 Water

ORDERING & TECH INFO

FOR UNMARKED FILLS

Pipe Size Inches	O.D. Flange Inches	Plain Bronze Std. Pkg. - 1 Pc.	Chrome Plated Bronze Std. Pkg. - 1 Pc.	Chrome Plated Bronze OEM Bulk Pkg. 10 Pcs.	Ship Wt. Carton Lbs. PLB/CHR/OEM Bulk
1	2-7/8	0528006PLB	0528006CHR	_____	0.8/0.8/-
1-1/4	3-5/16	0528007PLB	0528007CHR	_____	0.8/0.8/-
1-1/2	3-5/8	0528008PLB	0528DP8CHR*	0528008CHR	1.0/4.7/9.4
2	4-1/4	0528009PLB	0528009CHR	_____	2.0/2.1/-
2-1/2	4-5/8	0528010PLB	0528010CHR	_____	2.0/2.1/-
3	5-3/8	0528011PLB	0528011CHR	_____	3.0/3.1/-

FOR GAS FILLS**

Pipe Size Inches	O.D. Flange Inches	Plain Bronze Std. Pkg. - 1 Pc.	Chrome Plated Bronze Std. Pkg. - 1 Pc.	Chrome Plated Bronze OEM Bulk Pkg. 10 Pcs.	Ship Wt. Carton Lbs. PLB/CHR/OEM Bulk
1-1/2	3-5/8	0528G08PLB	0528DPGCHR*	0528G08CHR	1.0/5.0/9.5
2	4-1/4	_____	0528G09CHR	0528G09CHR	-/2.1/18.0

FOR DIESEL FILLS

Pipe Size Inches	O.D. Flange Inches	Plain Bronze Std. Pkg. - 1 Pc.	Chrome Plated Bronze Std. Pkg. - 1 Pc.	Chrome Plated Bronze OEM Bulk Pkg. 10 Pcs.	Ship Wt. Carton Lbs. PLB/CHR/OEM Bulk
1-1/2	3-5/8	0528D08PLB	0528DPDCHR*	0528D08CHR	1.0/5.1/9.5
2	4-1/4	0528D09PLB	0528D09CHR	_____	2.0/2.0/-

FOR WATER FILLS

Pipe Size Inches	O.D. Flange Inches	Plain Bronze Std. Pkg. - 1 Pc.	Chrome Plated Bronze Dealer. Pkg. 5 Pcs.	Chrome Plated Bronze OEM Bulk Pkg. 10 Pcs.	Ship Wt. Carton Lbs. PLB/CHR/OEM Bulk
1-1/2	3-5/8	0528W08PLB	0528DPWCHR	0528W08CHR	1.0/5.0/9.0

Screw Sizes: 2-1/2 and 3 Inch Deck Plates #10, All Others #8.

* Dealer Package 5 Pcs., 1 Pc. per Card

For Matching Waste Deck Plate See Fig. 0524 on Page 177.

SPARE PARTS ORDERING INFORMATION

Pipe Size Inches	Plain Bronze Cap with O-Ring	Chrome Plated Bronze Cap with O-Ring	O-Rings Only (2 per bag, 5 bags/Pkg)	Spare Key
1	0528P0699A	0528C0699A	0513006	1248006DP***
1-1/4	0528P0799A	0528C0799A	0513007	12487-8DP***
1-1/2	0528P0899A	0528DP899A*	0513DP8	12487-8DP***
2	0528P0999A	0528C0999A	0513009	1248009DP***
2-1/2	0528P1099A	0528C1099A	0513010	1248010ZNC
3	0528P1199A	0528C1199A	0513011	052801199C

* Dealer Pkg. - 5 pcs. (1 pc. per card)

*** Dealer Pkg. - 10 pcs. (1 pc. per card)

**NOTE: These Items Meet the Requirements of U.S.C.G. Safety Standards, January 31, 1977, for Gasoline Fuel Systems, 33 CFR 183. Fills shown on this page DO NOT meet the requirements for 40 CFR 1060 sub part B Emissions Standards and Related Requirements.

WASTE DECK PLATES



Fig. 0568



Fig. 1241

Fig. 0568 - OEM Bulk Packaged Waste Deck Plate with Color Coded Metallic Insert

CONSTRUCTION:

- Chrome Plated Bronze or Stainless Steel Scalloped Cap
- Color Coded Metallic Insert
- Black Polymer Base
- Deck Plate Key Included

ORDERING INFO			TECH INFO
Cap Type	OEM Bulk Pkg. 25 Pcs.	Ship Wt. Carton Lbs.	For Hose Size: 1-1/2" O.D. Flange: 3-3/8" Neck Length: 3-1/8" Mounting Hole Dia.: 2-1/8" Screw Size: #8
	Chrome 0568000CHR	OEM Bulk 19.5	
	Stainless 0568000STS	OEM Bulk 18.1	

7



Fig. 0569



Fig. 1241

Fig. 0569 - OEM Bulk Packaged Waste Deck Plate with Color Coded Resin Insert

CONSTRUCTION:

- Chrome Plated Bronze or Stainless Steel Scalloped Cap
- Color Coded Resin Insert
- Black Polymer Base
- Deck Plate Key Included

ORDERING INFO			TECH INFO
Cap Type	OEM Bulk Pkg. 25 Pcs.	Ship Wt. Carton Lbs.	For Hose Size: 1-1/2" O.D. Flange: 3-3/8" Neck Length: 3-1/8" Mounting Hole Dia.: 2-1/8" Screw Size: #8
	Chrome 0569000CHR	OEM Bulk 19.6	
	Stainless 0569000STS	OEM Bulk 18.2	

For Retail Packaged Waste Deck Plate With Resin Inserts See Fig. 0552 on Page 171.



Fig. 0556



Fig. 1247

Fig. 0556 - Waste Deck Plate for Hose

CONSTRUCTION:

- Chrome Plated Bronze & Black Polymer
- Deck Plate Key and O-Ring Included

ORDERING INFO			TECH INFO
Dealer Pkg. 5 Cards 1 Pc. per Card	OEM Bulk Pkg. 25 Pcs.	Ship Wt. Carton Lbs.	For Hose Size: 1-1/2" O.D. Flange: 3-3/8" Neck Length: 3-1/8" Mounting Hole Dia.: 2-1/8" Screw Size: #8
	0556DP0CHR	DP/OEM Bulk 3.8/17.5	

SPARE PARTS ORDERING INFORMATION

Cap with O-Ring: 0556DP099A Deck Plate Key: 1247DP0BLK



Fig. 0563

No Deck Plate Key Required

Fig. 0563 - Waste Deck Plate for Hose

CONSTRUCTION:

- Chrome Plated Bronze & Black Polymer

ORDERING INFO			TECH INFO
Dealer Pkg. 5 Cards 1 Pc. per Card	OEM Bulk Pkg. 25 Pcs.	Ship Wt. Carton Lbs.	For Hose Size: 1-1/2" O.D. Flange: 3-3/8" Neck Length: 3-1/8" Mounting Hole Dia.: 2-1/8" Screw Size: #8
	0563DP0CHR	DP/OEM Bulk 5.0/17.5	

SPARE PARTS ORDERING INFORMATION

Cap with O-Ring: 0563DP099A

NOTE: These Items Comply with Adopted Standards on "Fittings" A.B.Y.C. Recommended Practices Standards Covering Sewage Holding and/or Treatment Devices for Marine Waste Systems.

Fig. 0507 - Waste Deck Plate for Hose

CONSTRUCTION:

- Chrome Plated Bronze
- Deck Plate Key and O-Ring Included
- Cap Has a Slot Between the Holes



Fig. 1248



Fig. 0507

ORDERING INFO

Dealer Pkg.	OEM	Ship Wt.
5 Cards	Bulk Pkg.	Carton Lbs.
1 Pc. per Card	25 Pcs.	DP/OEM Bulk
0507DPOCHR	0507000CHR	4.0/20.0

TECH INFO

For Hose Size: 1-1/2"
O.D. Flange: 3-1/8"
Neck Length: 3-1/2"
Mounting Hole Dia.: 2-1/8"
Screw Size: #8

SPARE PARTS ORDERING INFORMATION

Cap with O-Ring: 0507DP099A
O-Rings Only (2 per bag): 0520DP099B
Deck Plate Key: 12487-8DP

Fig. 1269 - Waste Deck Plate for Hose

CONSTRUCTION:

- Chrome Plated Zinc Alloy
- Black Polymer Cap
- Deck Plate Key and O-Ring Included
- Cap Has a Slot Between the Holes



Fig. 1248



Fig. 1269

ORDERING INFO

Dealer Pkg.	OEM	Ship Wt.
5 Cards	Bulk Pkg.	Carton Lbs.
1 Pc. per Card	25 Pcs.	DP/OEM Bulk
1269DPOCHR	1269000CHR	3.9/18.0

TECH INFO

For Hose Size: 1-1/2"
O.D. Flange: 3-1/4"
Neck Length: 2-1/2"
Mounting Hole Dia.: 2-1/8"
Screw Size: #8

SPARE PARTS ORDERING INFORMATION

Cap with O-Ring: 1269DP099A
O-Rings Only (2 per bag): 0513DP8
Deck Plate Key: 12487-8DP

Fig. 0524 - Waste Deck Plate for Pipe

CONSTRUCTION:

- Chrome Plated Bronze
- Deck Plate Key and O-Ring Included
- Cap Has a Slot Between the Holes



Fig. 1248



Fig. 0524

ORDERING INFO

Dealer Pkg.	OEM	Ship Wt.
5 Cards	Bulk Pkg.	Carton Lbs.
1 Pc. per Card	10 Pcs.	DP/OEM Bulk
0524DPOCHR	0524000CHR	4.8/9.4

TECH INFO

For Pipe Size: 1-1/2"
O.D. Flange: 3-5/8"
Screw Size: #8

SPARE PARTS ORDERING INFORMATION

Cap with O-Ring: 0524DP099A
O-Rings Only (2 per bag): 0513DP8
Deck Plate Key: 12487-8DP

NOTE: These Items Comply with Adopted Standards on "Fittings" A.B.Y.C. Recommended Practices Standards Covering Sewage Holding and/or Treatment Devices for Marine Waste Systems.

FUEL SYSTEM LOCKING INSERTS AND CAPS

Fig. 0525 Display



Fig. 0525 - Fuel System Locking Insert for 1-1/2" Vented Fills

CONSTRUCTION:

- Black Polymer with Zinc Alloy Lock Cylinder
- Dual Purpose Key Opens Fill Cap & Locking Insert
 - Fits Most PERKO® Vented Fills
- Available in Dealer Package or 12 Piece Countertop Display



Fig. 0525

ORDERING & TECH INFO

Dealer Pkg. - 5 Cards 1 Pc. Per Card 0525DP0BLK	P.O.P. Display 12 Pcs. 0525DP0DIS	Ship Wt. Carton Lbs. DP/P.O.P. Display 1.2/3.3
---	---	--



Fig. 1324 - Fuel System Locking Cap For 1-1/2" Non-Vented Fills

CONSTRUCTION:

- Black Polymer with Gasket
- Built in Lock Cylinder
- Size #0 Fits PERKO Fills 1313 & 1399
- Size #1 Fits PERKO Fills 0520, 0527, 0528, 0557, 0599 and 1270



Fig. 1324

Fig. 0520 Fill Shown with Locking Cap



ORDERING & TECH INFO

Dealer Pkg. 5 Cards 1 Pc. Per Card 1324DP0BLK 1324DP1BLK	Cap Outside Thread Diameter Inches 1-15/32 1-7/8	Ship Wt. Carton Lbs. Dealer Pkg. 1.0 1.1
--	--	--

Fig. 1241 - Deck Plate Key

CONSTRUCTION:

- Black Polymer
- 2 Holes for Key Chain

Fits PERKO 0552, 0568, 0569, 0580, 0581, 0582 and 0583 Deck Plates
Also fits PERKO 1-1/4" and 1-1/2" Deck Plates
and Many Other "Slot" Type Opening Deck Plates



Fig. 1241

ORDERING INFO			TECH INFO
Dealer Pkg. 10 Cards 1 Pc. per Card 1241DPOBLK	OEM Bulk Pkg. 50 Pcs. 1241000BLK	Ship Wt. Carton Lbs. DP/OEM Bulk 1.0/2.0	Center to Center of Lugs: 1-1/8" Length Spade: 1" Length Overall: 4"

7

Fig. 1247 - Deck Plate Key

CONSTRUCTION:

- Black Polymer

Compact Size with Hole for Key Chain. Fits PERKO 1-1/4" and 1-1/2" Deck Plates
and Many Other "Slot" Type Opening Deck Plates



Fig. 1247

ORDERING INFO			TECH INFO
Dealer Pkg. 10 Cards 1 Pc. per Card 1247DPOBLK	OEM Bulk Pkg. 50 Pcs. 1247000BLK	Ship Wt. Carton Lbs. DP/OEM Bulk 0.7/0.7	Center to Center of Lugs: 1-1/8" Length Spade: 1" Length Overall: 1-3/4"

Fig. 1248 - Deck Plate Key

CONSTRUCTION:

- Black Polymer or Zinc Alloy

The Keys For 1" Thru 1-1/2" Deck Plates Have a 1 Inch Spade on Handle
That Fit Many Other "Slot" Type Opening Deck Plates



Fig. 1248

ORDERING & TECH INFO						
For Deck Plate Size Inches	C. to C. of Lugs	Length Overall Inches	Material	Dealer Pkg. 10 Cards 1 Pc. per Card	Std. Pkg. 50 Pcs.	Ship Wt. Carton Lbs. DP/Std. Pkg.
1	5/8	3-3/8	Polymer	1248006DP	—	1.0/-
1-1/4 & 1-1/2	1-1/8	3-3/8	Polymer	12487-8DP	12487-8BLK	1.0/1.4
2	1-11/16	4-3/8	Zinc	1248009DP	—	2.0/-
2-1/2	2	4-3/8	Zinc	—	1248010ZNC*	-/0.2

*Standard Pkg. - 1 Pc.

Fig. 0826 - Adjustable Deck Plate Key

CONSTRUCTION:

- Chrome Plated Zinc Alloy
- Hardened Steel Pin
- Will Fit Sizes up to 8 Inch Diameter



Fig. 0826

ORDERING & TECH INFO		
Length Overall Inches 8-1/2	Dealer Pkg. - 5 Cards 1 Pc. per Card 0826DPOCHR	Ship Wt. Carton Lbs. Dealer Pkg. 3.4



Fig. 0598
Shown with White
Splash Guard

Fig. 0598 - 90° Angled Tank Vent

CONSTRUCTION:

- Stainless Steel Escutcheons with Black or White Polymer Splash Guard
 - Removable 30 Mesh Stainless Steel Wire Screen Flame Arrestor (for use with gasoline applications)

ORDERING & TECH INFO

Color	Hose Size Inches	Max. Hull Thickness Inches	Dealer Pkg. 5 Cards 1 Pc. per Card	OEM Bulk Pkg. 50 Pcs.	Ship Wt. Carton Lbs. DP/OEM Bulk
Black	5/8	5/8	0598DP4BLK	0598004BLK	3.2/13.0
White	5/8	5/8	0598DP4WHT	0598004WHT	3.2/13.0

7



Fig. 0571

Fig. 0571 - Tank Vent with Swivel Elbow

CONSTRUCTION:

- Zinc Alloy Elbow
 - Black or White Polymer Cap
- Removable 30 Mesh Stainless Steel Wire Screen Flame Arrestor (for use with gasoline applications)

Design Allows Elbow to be Rotated to any Position

ORDERING INFO

Color	Dealer Pkg. 10 Cards 1 Pc. per Card	OEM Bulk Pkg. 50 Pcs.	Ship Wt. Carton Lbs. DP/OEM Bulk
Black	0571DP4BLK	0571004BLK	2.4/9.3
White	0571DP4WHT	0571004WHT	2.4/9.3

TECH INFO

Hose Size: 5/8"
Max. Hull Thickness: 3/4"



Fig. 0561

Fig. 0561 - Tank Vent with Swivel Elbow

CONSTRUCTION:

- Chrome Plated Zinc Alloy Cap with Zinc Alloy Elbow
 - Black or White Polymer Splash Guard
- Removable 30 Mesh Stainless Steel Wire Screen Flame Arrestor (for use with gasoline applications)

Design Allows Elbow to be Rotated to any Position

ORDERING INFO

Color	10 Cards 1 Pc. per Card	Bulk Pkg. 50 Pcs.	Ship Wt. Carton Lbs. DP/OEM Bulk
Black	0561DP4CHR	0561004CHR	2.8/11.5
White*	0561DP4WHT	0561004WHT	2.8/11.5

TECH INFO

Hose Size: 5/8"
Max. Hull Thickness: 1"

Splash Guard Black: Cat. No. 0518000BLK
Splash Guard White: Cat. No. 0518000WHT

Note: All of the Above Vents are Designed to Meet the Requirements of U.S.C.G. Safety Standards January 31, 1977, for Gasoline Fuel Systems 33 CFR 183.

Fig. 0597 - Straight Tank Vent



CONSTRUCTION:

- Stainless Steel Escutcheons with Black or White Polymer Splash Guard
- Removable 30 Mesh Stainless Steel Wire Screen Flame Arrestor (for use with gasoline applications)



Fig. 0597
Shown with Black
Splash Guard

ORDERING & TECH INFO

	Hose Size	Max. Hull Thickness	Dealer Pkg. 5 Cards	OEM Bulk Pkg. 50 Pcs.	Ship Wt. Carton Lbs. DP/OEM Bulk
Color	Inches	Inches	1 Pc. per Card		
Black	5/8	5/8	0597DP4BLK	0597004BLK	3.5/14.4
White	5/8	5/8	0597DP4WHT	0597004WHT	3.5/14.4

7

Fig. 0570 - Straight Tank Vent



CONSTRUCTION:

- Chrome Plated Zinc Alloy Cowl
- Black or White Polymer Cap
- Removable 30 Mesh Stainless Steel Wire Screen Flame Arrestor (for use with gasoline applications)



Fig. 0570



ORDERING INFO

TECH INFO

	Dealer Pkg. 10 Cards	OEM Bulk Pkg. 50 Pcs.	Ship Wt. Carton Lbs. DP/OEM Bulk	
Color	1 Pc. per Card			
Black	0570DP4BLK	0570004BLK	2.4/9.5	Hose Size: 5/8" Max. Hull Thickness: 3/4"
White	0570DP4WHT	0570004WHT	2.4/9.5	

Fig. 0506 - Straight Tank Vent



CONSTRUCTION:

- Chrome Plated Zinc Alloy with Black or White Polymer Splash Guard
- Removable 30 Mesh Stainless Steel Wire Screen Flame Arrestor (for use with gasoline applications)

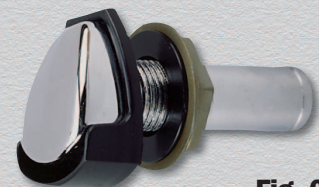
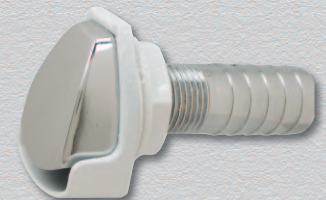

Fig. 0506



ORDERING INFO

TECH INFO

	Dealer Pkg. 10 Cards	OEM Bulk Pkg. 50 Pcs.	Ship Wt. Carton Lbs. DP/OEM Bulk	
Color	1 Pc. per Card			
Black	0506DP4CHR	0506004CHR	2.1/8.1	Hose Size: 5/8" Max. Hull Thickness: 3/4"
White*	0506DP4WHT	0506004WHT	2.1/8.1	

Splash Guard Black: Cat. No. 0518000BLK
Splash Guard White: Cat. No. 0518000WHT

Note: All of the Above Vents are Designed to Meet the Requirements of U.S.C.G. Safety Standards January 31, 1977, for Gasoline Fuel Systems 33 CFR 183.



Fig. 0509 - Tank Vent

CONSTRUCTION:

- Chrome Plated Bronze
- Removable 30 Mesh Stainless Steel Wire Screen Flame Arrestor (for use with gasoline applications)

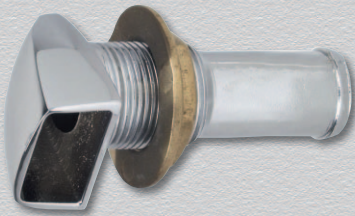

Fig. 0509

ORDERING & TECH INFO

Hose Size Inches	Max. Hull Thickness Inches	Dealer Pkg. 5 Cards 1 Pc. per Card	OEM Bulk Pkg. 50 Pcs.	Ship Wt. Carton Lbs. DP/OEM Bulk
5/8	3/4	0509DP4CHR	0509004CHR	1.3/10.4
3/4	5/8	0509DP5CHR	0509005CHR	1.6/13.4

7

Fig. 0503 - Tank Vent

CONSTRUCTION:

- Chrome Plated Bronze
- Removable 30 Mesh Stainless Steel Wire Screen Flame Arrestor (for use with gasoline applications)



Fig. 0503

ORDERING & TECH INFO

Thread Size Inches	Max. Hull Thickness Inches	Dealer Pkg. 5 Cards 1 Pc. per Card	OEM Bulk Pkg. 50 Pcs.	Ship Wt. Carton Lbs. DP/OEM Bulk
3/8	7/8	0503DP3CHR	0503003CHR	2.1/16.0
1/2	7/8	0503DP4CHR	0503004CHR	1.9/15.5

Fig. 0515 - Tank Vent

CONSTRUCTION:

- Chrome Plated Bronze
- Removable 30 Mesh Stainless Steel Wire Screen Flame Arrestor (for use with gasoline applications)



Fig. 0515

ORDERING & TECH INFO

Thread Size Inches	Max. Hull Thickness Inches	Dealer Pkg. 5 Cards 1 Pc. per Card	OEM Bulk Pkg. 50 Pcs.	Ship Wt. Carton Lbs. DP/OEM Bulk
3/8	5/8	0515DP3CHR	0515003CHR	1.1/8.9
1/2	5/8	0515DP4CHR	0515004CHR	1.3/10.5

Fig. 0505 - Tank Vent

CONSTRUCTION:

- Chrome Plated Cast Bronze
- Removable 30 Mesh Stainless Steel Wire Screen Flame Arrestor (for use with gasoline applications)

Designed to meet the requirements of the National Fire Protection Association Booklet No. 302, Section No. 323 on vent pipe outlets. The 1/2 inch N.P.T. is off center to create a water baffle.

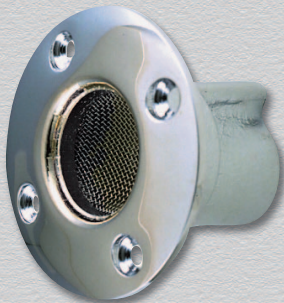

Fig. 0505

ORDERING INFO

Dealer Pkg. 10 Cards 1 Pc. per Card	OEM Bulk Pkg. 50 Pcs.	Ship Wt. Carton Lbs. DP/OEM Bulk
0505DPOCHR	0505000CHR	2.5/10.8

TECH INFO

O.D. Flange: 2-1/2"
O.D. Neck: 1-3/16"
Length Neck: 1-1/2"
Screw Size: #8

Note: All of the Above Vents are Designed to Meet the Requirements of U.S.C.G. Safety Standards January 31, 1977, for Gasoline Fuel Systems 33 CFR 183.

**Fig. 0499 - Water Inlet Fitting
For Obtaining Water At Dockside**

CONSTRUCTION:

- Chrome Plated Bronze
- Standard Female Swivel Hose Connector
- Black Polymer Watertight Plug
- Stainless Steel Bead Chain



Fig. 0499

ORDERING & TECH INFO

Pipe Size Inches	O.D. Flange Inches	Dealer Pkg. 5 Cards 1 Pc. per Card	OEM Bulk Pkg. 10 Pcs.	Screw Size	Ship Wt. Carton Lbs. DP/OEM Bulk
1/2	2-3/4	0499DP0CHR	0499000CHR	8	2.6/4.7

Spare Plug with Chain: 0499DP099A.

7

**Fig. 0504 - Water Outlet Fitting
For Use with On-Board Washdown Systems**

CONSTRUCTION:

- Chrome Plated Bronze
- Standard Male Hose Connector
- Watertight Black Polymer Cap
- Stainless Steel Bead Chain



Fig. 0504

ORDERING & TECH INFO

Pipe Size Inches	O.D. Flange Inches	Dealer Pkg. 5 Cards 1 Pc. per Card	OEM Bulk Pkg. 10 Pcs.	Screw Size	Ship Wt. Carton Lbs. DP/OEM Bulk
1/2	2-3/4	0504DP0CHR	0504000CHR	8	2.2/3.9

Spare Cap with Chain: 0504DP099A

Fig. 0526 - Regular Deck Plate

CONSTRUCTION:

- Cast Bronze
- Plain or Chrome Plated
- Deck Plate Key Included

ORDERING & TECH INFO

I.D. Opening Inches	O.D. Overall Inches	Plain Bronze Standard Pkg. - 1 Pc.	Chrome Plated Bronze Standard Pkg. - 1 Pc.	Screw Size	Ship Wt. Carton Lbs. Std. Pkg. PLB/CHR
3	5-3/8	0526003PLB	0526003CHR	10	2.1/2.3
4	7-1/16	0526004PLB	0526004CHR	10	3.6/3.7
5	8-3/8	0526005PLB	0526005CHR	10	5.3/5.6
6	9-3/8	0526006PLB	0526006CHR	1/4	7.5/7.6

SPARE PARTS ORDERING INFORMATION

I.D. Opening Inches	Plain Bronze Cap	Chrome Plated Bronze Cap	Spare Key Only
3	0526P0399A	0526C0399A	1248010ZNC
4	0526P0499A	0526C0499A	0539004PLB
5	0526P0599A	0526C0599A	0539005PLB
6	0526P0699A	0526C0699A	0539006PLB

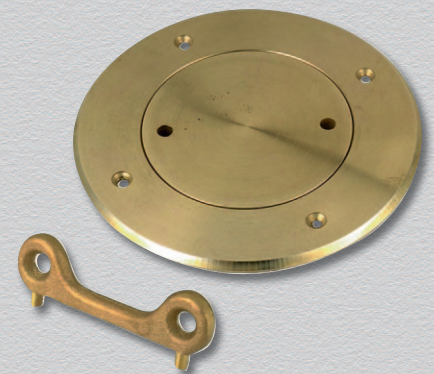

Fig. 0526

ALSO AVAILABLE IN
MARINIUM
Contact Factory

Fig. 0572 - Open Base Cleat

CONSTRUCTION:

- Chrome Plated Bronze



Fig. 0572



Shown in Marinium

ORDERING & TECH INFO

Length Overall Inches	Dimensions Base Inches	Max. Rope Size Inches	Dealer Pkg. 5 Cards 1 Pc. per Card	Standard Package - 1 Pc.	OEM Bulk Pkg. 10 Pcs.	Screw Size	Ship Wt. Carton Lbs. DP/Std. Pkg/OEM Bulk
8	4 x 2-1/4	3/4	0572DP8CHR	————	0572008CHR	1/4	9.9/-/17.8
10	5-1/16 x 2-13/16	7/8	————	0572010CHR	————	5/16	-/3.5/-
12	6-1/16 x 2-7/8	1	————	0572012CHR	————	5/16	-/4.7/-
15	7-3/8 x 3-5/8	1-1/2	————	0572015CHR	————	3/8	-/8.1/-

8

Fig. 1188 - Open Base Cleat

CONSTRUCTION:

- Chrome Plated Zinc Alloy



Fig. 1188

ORDERING & TECH INFO

Length Overall Inches	Dimensions Base Inches	Max. Rope Size Inches	Dealer Pkg. 5 Cards 1 Pc. per Card	OEM Bulk Pkg. Catalog No.	OEM Bulk Pkg.	Screw Size	Ship Wt. Carton Lbs. DP/OEM Bulk
4	2-1/8 x 1-1/2	5/16	1188DP4CHR*	1188004CHR	50	10	3.1/15.4
6	3 x 1-3/4	7/16	1188DP6CHR	1188006CHR	50	10	3.4/30.0
8	4 x 2-1/8	5/8	1188DP8CHR	1188008CHR	25	1/4	4.7/21.0

CAMO VERSIONS
Contact The Factory

* Dealer Package, 5 cards - 2 Pcs. per card.

Fig. 1210 - Open Base Cleat

CONSTRUCTION:

- Chrome Plated Zinc Alloy
- Stainless Steel Studs, Nuts and Washers

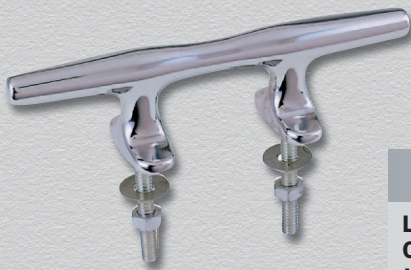

Fig. 1210

ORDERING & TECH INFO

Length Overall Inches	Dimensions Base Inches	Max. Rope Size Inches	Catalog Number	OEM Std. Pkg.	OEM Bulk Pkg.	Stud Size	Ship Wt. Carton Lbs. Std. Pkg./OEM Bulk
4	2-1/8 x 1-1/2	5/16	1210004CHR	10	50	1/4-20 x 2	3.8/19.5
6	3 x 1-3/4	7/16	1210006CHR	10	30	1/4-20 x 2	6.6/21.8
8	4 x 2-1/8	5/8	1210008CHR	5	30	1/4-20 x 2	5.0/29.4

Fig. 0545 - Cleat

CONSTRUCTION:

- Aluminum



Fig. 0545



ORDERING & TECH INFO

Length Overall Inches	Dimensions Base Inches	Max. Rope Size Inches	Dealer Pkg. 5 Cards 2 Pcs. per Card	OEM Bulk Package	OEM Bulk Pkg. Pcs./Pkg.	Screw Size	Ship Wt. Carton Lbs. DP/OEM Bulk
3	1-1/2 x 5/8	1/4	0545DP3ALU	_____	—	8	1.0/-
4	1-5/8 x 3/4	5/16	0545DP4ALU	_____	—	10	1.2/-
5	2 x 7/8	3/8	0545DP5ALU	_____	—	1/4	1.8/-
6	2-1/4 x 7/8	7/16	0545DP6ALU**	0545006ALU	50	1/4	3.0/10.0
8*	2-5/8 x 1-7/8	5/8	0545DP8ALU**	0545008ALU	25	1/4	4.8/9.0
10*	3-5/8 x 1-1/2	3/4	_____	0545010ALU	5	5/16	-/3.0
12*	4 x 1-1/2	7/8	_____	0545012ALU	5	5/16	-/4.2

* These Sizes are Open Base, Balance of Sizes are Closed Base.

** Dealer Package, 10 pcs., 1 Pc. per card.

Fig. 0544 - Cleat

CONSTRUCTION:

- Cast Bronze
- Polished or Chrome Plated



Fig. 0544 Polished



Fig. 0544 Chrome

ORDERING & TECH INFO

Overall Inches	Base Inches	Max. Rope Size Inches	Chrome Plated Bronze Dealer Pkg.	Polished Bronze Dealer Pkg.	Dealer Pkg. - 5 Cards Pcs. per Card	Screw Size	Ship Wt. Carton Lbs. Dealer Pkg.
3	1-1/2 x 5/8	1/4	0544DP3CHR	0544DP3POL	2	8	1.9
4	1-5/8 x 3/4	5/16	0544DP4CHR	0544DP4POL	1	10	1.6



Fig. 0566

Fig. 0566 - Closed Base Cleat

CONSTRUCTION:

- Chrome Plated Zinc Alloy

ORDERING & TECH INFO						
Length Overall Inches	Dimensions Base Inches	Max. Rope Size Inches	Dealer Pkg. 5 Cards 2 Pcs. per Card	Screw Size	Ship Wt. Carton Lbs. Dealer Pkg.	
2	2-3/16 x 1-1/8	5/16	0566DP2CHR	6	1.3	
3	3-1/8 x 1-1/2	3/8	0566DP3CHR	8	3.1	
4-1/2	4-7/16 x 1-7/8	1/2	0566DP4CHR	10	6.0	

8



Fig. 1252

Fig. 1252 - Open Base Cleat

CONSTRUCTION:

- Chrome Plated Zinc Alloy

ORDERING & TECH INFO						
Length Overall Inches	Dimensions Base Inches	Max. Rope Size Inches	Dealer Pkg. 5 Cards 2 Pcs. per Card	OEM Bulk Pkg. 50 Pcs.	Screw Size	Ship Wt. Carton Lbs. DP/OEM Bulk
6-1/2	3 x 1-1/8	3/4	1252DPOCHR	1252000CHR	1/4	4.6/34.5



Fig. 0530

Fig. 0530 - Open Base Cleat

CONSTRUCTION:

- Plain Aluminum

ORDERING & TECH INFO						
Length Overall Inches	Dimensions Base Inches	Max. Rope Size Inches	Standard Package - 1 Pc.	Screw Size	Ship Wt. Carton Lbs. Std. Pkg.	
8	4 x 2-1/4	3/4	0530008ALU	1/2	1.2	
10	4-1/2 x 3	7/8	0530010ALU	1/2	2.0	
12	6-1/2 x 2-7/8	1	0530012ALU	5/8	4.0	
15	7 x 3-1/4	1-1/2	0530015ALU	3/4	5.0	

Fig. 1305 - Closed Base Cleat**CONSTRUCTION:**

- Chrome Plated Zinc Alloy
- Black Polymer Base

ORDERING & TECH INFO

Length Overall Inches	Max. Rope Size Inches	Dealer Package	Dealer Pkg. 5 Cards Pcs. per Card	Screw Size	Ship Wt. Carton Lbs. DP
4-1/2	3/8	1305DP1CHR	2	10	3.5
6	1/2	1305DP2CHR	1	1/4	3.5

**Fig. 1305****Fig. 1316 - Open Base Cleat****CONSTRUCTION:**

- Chrome Plated Zinc Alloy
- Black Polymer Base
- Stainless Steel Studs, Nuts and Washers

ORDERING & TECH INFO

Length Overall Inches	Max. Rope Size Inches	Catalog Number	Std. Pkg.	OEM Bulk Pkg.	Stud Size	Ship Wt. Carton Lbs. Std. Pkg./OEM Bulk
4-1/2	3/8	1316001CHR	1	50	12-24 x 1-1/2	0.4/18.0
6	1/2	1316002CHR	1	—	1/4 x 1-1/2	0.7/27.9

**Fig. 1316****Fig. 1306 - Open Base Cleat****CONSTRUCTION:**

- Chrome Plated Zinc Alloy
- Black Polymer Base

ORDERING & TECH INFO

Length Overall Inches	Max. Rope Size Inches	Dealer Package	Dealer Pkg. 5 Cards Pcs. per Card	OEM Bulk Pkg. 50 Pcs.	Screw Size	Ship Wt. Carton Lbs. DP/OEM Bulk
4-1/2	3/8	1306DP1CHR	2	1306001CHR	10	2.7/11.8
6	1/2	1306DP2CHR	1	1306002CHR	1/4	3.3/30.4

**Fig. 1306****Fig. 1326 - Open Base Cleat****CONSTRUCTION:**

- Chrome Plated Zinc Alloy
- Black Polymer Base

ORDERING & TECH INFO

Length Overall Inches	Dimensions Base Inches	Max. Rope Size Inches	Dealer Pkg. 5 Cards 1 Pc. per Card	OEM Bulk Pkg. 50 Pcs.	Screw Size	Ship Wt. Carton Lbs. DP/OEM Bulk
5-3/4	3-5/8 x 7/8	1/2	1326DP2CHR	1326002CHR	1/4	2.1/19.0

**Fig. 1326**



ALSO AVAILABLE IN
MARINIUM
Contact Factory

Fig. 0119 - Straight Chock

CONSTRUCTION:

- Chrome Plated Bronze



Fig. 0119



Shown in Marinium

ORDERING & TECH INFO

Max. Rope Size Inches	Length Overall Inches	Width Inches	Dealer Pkg. 5 Cards 1 Pc. per Card	OEM Bulk Pkg. 5 Pcs.	Screw Size	Ship Wt. Carton Lbs. DP/OEM Bulk
3/4	4	7/8	0119DP4CHR	0119004CHR	8	2.0/1.7
1	6	1-1/8	0119DP6CHR	0119006CHR	12	4.0/3.8

8

Fig. 1230 - Straight Chocks

CONSTRUCTION:

- Chrome Plated Zinc Alloy



Fig. 1230

ORDERING & TECH INFO

Max. Rope Size Inches	Length Overall Inches	Width Inches	Dealer Pkg. 10 Cards 1 Pair per Card	OEM Bulk Pkg. 50 Pairs	Screw Size	Ship Wt. Carton Lbs. DP/OEM Bulk
3/4	4	7/8	1230DP0CHR	1230000CHR	8	4.8/22.0

Fig. 1223 - Skene Bow Chocks

CONSTRUCTION:

- Chrome Plated Zinc Alloy



Fig. 1223

ORDERING & TECH INFO

Max. Rope Size Inches	Length Overall Inches	Width Inches	Dealer Pkg. 5 Cards 1 Pair per Card	OEM Bulk Pkg. 50 Pairs	Screw Size	Ship Wt. Carton Lbs. DP/OEM Bulk
1/2	3-1/2	7/8	1223DP0CHR	1223000CHR	8	1.7/14.4

ANCHOR CHOCK & RIGGING TUBE

CONSTRUCTION:

- Polished or Burnished Chrome Plated Bronze

Size No. 1 Fits

Fortress Model
FX7-FX16

Danforth® Models

T®11-570	S®160
T®11-1200	S®300
T®11-1800	S®600
T®11-2500	S®920
T®11-3000	S®1300

Size No. 2 Fits

Fortress Model
FX23-FX55

Danforth® Models

T®11-4000	S®1600
T®11-6000	S®2000
T®11-7000	S®3000
	S®3500



Fig. 0903

8

ORDERING & TECH INFO

Polished Chrome Plated Bronze	Burnished Chrome Plated Bronze	Screw Size	Ship Wt. Carton Lbs. CHR/BUR
Dealer Pkg. - 5 Cds. 1 Set per Card	Dealer Pkg. - 5 Cds. 1 Set per Card		
0903DP1CHR	0903DP1BUR	10	12.3/12.1
0903DP2CHR	0903DP2BUR	10	14.0/13.6

SPARE PARTS ORDERING INFORMATION

To Specify Size Replace the **Seventh** Digit With the Size Number (i.e. 090300**1**99A or 090300**2**99A).

Polished Chrome Shank Support: 090300_99A
 Polished Chrome Fluke Supports, Pair: 090300_99B
 Polished Chrome Crown Support: 090300_99C
 Knob: 1144A00BLK

Burnished Chrome Shank Support: 0903B0_99A
 Burnished Chrome Fluke Supports, Pair: 0903B0_99B
 Burnished Chrome Crown Support: 0903B0_99C



Fig. 0357 - Rigging Tube

CONSTRUCTION:

- Chrome Plated Brass and Bronze

For use with 2 Inch I.D. Hose to Pass Wiring Harnesses and Control Cables Through Transoms and Motorwell Bulkheads Mounts in 2-1/8 Inch Diameter Hole

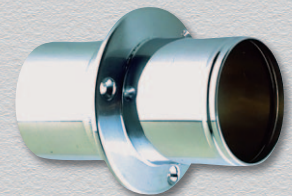

Fig. 0357

ORDERING & TECH INFO

O.D. Tube Inches	Length Overall Inches	O.D. Flange Inches	Dealer Pkg. 5 Cards 1 Pc. per Card	Std. Pkg - 5 Pcs. OEM Bulk Pkg. 25 Pcs.	Screw Size	Ship Wt. Carton Lbs. DP/Std/OEM Bulk
2	4-1/8	3-1/8	0357DP1CHR	0357001CHR	8	3.7/2.7/12.9



ALSO AVAILABLE IN
MARINIUM
Contact Factory

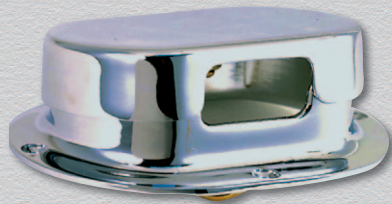

Fig. 0750
Chrome



Fig. 0750
Shown in Marinium

Fig. 0750 - Rope and Chain Deck Pipe

CONSTRUCTION:

- Chrome Plated Bronze
- The Cover Has a Hook for Hanging Chain and a Stainless Steel Cable Retainer

8

ORDERING & TECH INFO					
Opening For Chain Size Inches	Dimensions Flange Inches	Height Overall Inches	Dealer Pkg. 5 Cards 1 Pc. per Card	Screw Size	Ship Wt. Carton Lbs. Dealer Pkg.
3/8	5-1/4 x 4	1-3/8	0750DPOCHR	8	9.6

Spare Cover with Hook and Cable, Cat. No. 0750DP099A

Fig. 1057 White



Fig. 1057 - Rope Deck Pipe

CONSTRUCTION:

- High Impact Black or White Polymer
 - U.V. Stabilized, Fiber Reinforced
 - Hinged, Snap-Down Cover
- Hinge Design Allows Open Cover to Lay Flat



Fig. 1057 Black

ORDERING & TECH INFO						
Color	Maximum Rope Size Inches	O.D. Flange Inches	Dealer Pkg. 5 Cards 1 Pc. per Card	OEM Bulk Pkg. 25 Pcs.	Screw Size	Ship Wt. Carton Lbs. DP/OEM Bulk
Black	7/8	3-3/4	1057DPOBLK	1057000BLK	8	1.7/5.7
White	7/8	3-3/4	1057DPOWHT	1057000WHT	8	1.7/5.7

Fig. 0757 - Rope Deck Pipe

CONSTRUCTION:

- Chrome Plated Zinc Alloy



Fig. 0757

ORDERING & TECH INFO					
Maximum Rope Size Inches	O.D. Flange Inches	Dealer Pkg. 5 Cards 1 Pc. per Card	OEM Bulk Pkg. 10 Pcs.	Screw Size	Ship Wt. Carton Lbs. DP/OEM Bulk
1	3-3/8	0757DPOCHR	0757000CHR	8	2.9/5.4

MOORING BITT, HAWSE HOLE PLATES & BOW EYE

Fig. 0608 - Mooring Bitt

CONSTRUCTION:

- Chrome Plated Bronze, Hollow



Fig. 0608

ORDERING & TECH INFO

Dimensions Base Inches	Height Inches	Standard Pkg. 1 Pc.	Bolt Size	Ship Wt. Carton Lbs. Std. Pkg.
4-1/4 x 4-1/4	3-1/2	0608002CHR	1/4	2.3
5 x 5	4-3/4	060802ACHR	3/8	3.5
6 x 6	5	0608003CHR	3/8	6.1

Fig. 0752 - Oval Hawse Hole Plate

CONSTRUCTION:

- Chrome Plated Bronze or Marinium Alloy

Fig. 0755 - Triangular Hawse Hole Plate

CONSTRUCTION:

- Marinium Alloy



Fig. 0752 Chrome



Fig. 0752 Marinium



Fig. 0755 Marinium



8

ORDERING & TECH INFO

Finish	Dimensions Outside Inches	Dimensions Inside Inches	Length Spigot Inches	Std. Pkg. - 1 Pc.	Screw Size	Ship Wt. Carton Lbs. Std. Pkg./OEM Bulk
Chrome Bronze	4-1/4 x 6	2-1/8 x 4-1/8	1-1/4	0752000CHR*	1/4	1.6/—
Marinium	4-1/4 x 6	2-1/8 x 4-1/8	1-1/4	0752000MAR	1/4	0.6/8.5
Marinium	8-1/4 x 5-1/8	3-1/8 x 5-1/4	1-3/4	0755000MAR	1/4	1.5/—

* Available
OEM Bulk Pkg. 10 Pcs.

NOTE: The Bow Eye Illustrated on This Page is Not Designed to Bear the Weight of the Vessel and Therefore Should Not Be Used For Lifting

Fig. 1235 - Bow Eye

CONSTRUCTION:

- Chrome Plated Zinc Alloy Eye
- Zinc Alloy Plated Steel "U" Bolt, Nuts & Washers

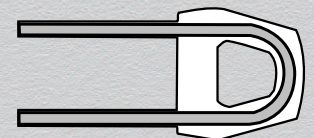
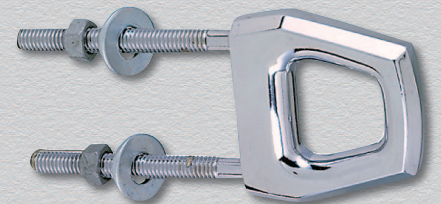

Fig. 1235

ORDERING & TECH INFO

Length Shank Inches	O.D. Shank Inches	I.D. Eye Inches	Length Thread Inches	Dealer Pkg. 10 Cards 1 Pc. per Card	Ship Wt. Carton Lbs. Dealer Pkg.	Safe Working Load Pounds**
3	5/16	1	2-3/4	1235DPOCHR	6.6	2000

****IMPORTANT NOTE: The Safe Working Load Information Given for the Item Above is Based on a Straight Axial Pull. This Information Would Not Apply in Cases Where Installation or Use Creates Angular Loading, Since These Variations Make it Impracticable to Offer Accurate Test Data.**

STEP PLATES, FIXED & FOLDING STEPS

Figs. 1043 & 1325 - Step Plates

CONSTRUCTION:

- Soft Black Polymer Pads

Fig. 1043 - Chrome Plated Bronze Frames

Fig. 1325 - Chrome Plated Zinc Alloy Frames



Fig. 1043



Fig. 1325

ORDERING & TECH INFO

Dimensions Inches	Dealer Pkg. 5 Cards 1 Pc. per Card	OEM Bulk Pkg. 50 Pcs.	Screw Size	Ship Wt. Carton Lbs. DP/OEM Bulk
8-3/4 x 3-1/4	1043DP1CHR	—	8	4.8/-
11-1/2 x 5-3/4	1043DP2CHR	—	8	10.2/-
8-3/8 x 2-1/4	1325DPOCHR*	1325000CHR	8	3.8/16.1
8-3/4 x 3-1/4	1325DP1CHR*	1325001CHR	8	5.2/22.4

* Dealer Pkg. 2 Pcs. per card.

Spare Pads for Size No. 0 (2 per bag): 1050DP0BLK
 Spare Pads for Size No. 1 (2 per bag): 1050DP1BLK
 Spare Pads for Size No. 2 (2 per bag): 1050DP2BLK

Fig. 1015 - Step Plate

CONSTRUCTION:

- Chrome Plated Brass Frame
- Soft Black Polymer Tread Insert



Fig. 1015

ORDERING & TECH INFO

Dimensions Inches	Dealer Pkg. 5 Cards 2 Pcs. per Card	O.E.M. Bulk Pkg. 50 Pcs.	Screw Size	Ship Wt. Carton Lbs. DP/OEM Bulk
7-1/4 x 1-1/2	1015DPOCHR	1015000CHR	8	1.8/6.7

Figs. 0351 & 0501 - Fixed Steps

CONSTRUCTION:

- Chrome Plated Bronze



Fig. 0351



Fig. 0501

ORDERING & TECH INFO

Dimensions Step Inches	Dimensions Bracket Inches	Dealer Pkg. 5 Cards 1 Pc. per Card	Standard Pkg. - 1 Pc.	Bolt Size	Ship Wt. Carton Lbs. DP/Std. Pkg.
6 x 4-1/4	6 x 2	0351DPOCHR	—	5/16 R.H.	11.1/-
11 x 4-1/2	11 x 2	—	0501000CHR	5/16 R.H.	-/4.3

Fig. 0344 - Folding Step

CONSTRUCTION:

- Chrome Plated Manganese Bronze
- Stainless Steel Spring Holds Step in Open or Closed Position**



Fig. 0344

ORDERING & TECH INFO

Dimensions Step Inches	Dimensions Bracket Inches	Projection Folded Inches	Dealer Pkg. 5 Cards 1 Pc. per Card	Bolt Size	Ship Wt. Carton Lbs. Dealer Pkg.
4-1/8 x 2-1/4	4-1/4 x 1-3/4	1-3/8	0344DPOCHR	5/16 R.H.	8.5



Fig. 1234 - Bow Handle for Daysailors

CONSTRUCTION:

- Chrome Plated Zinc Alloy

ORDERING INFO			TECH INFO
Dealer Pkg. 5 Cards	OEM Bulk Pkg. 50 Pcs.	Ship Wt. Carton Lbs. DP/OEM Bulk	Length Overall: 6-1/2" Ht. Above Deck: 2" Screw Size: #8
1 Pc. per Card 1234DPOCHR	1234000CHR	3.0/18.7	



Fig. 1234

Figs. 1336 & 1346 - Handles

CONSTRUCTION:

- Chrome Plated Zinc Alloy
- Black Polymer Base
- Stainless Steel Studs, Nuts and Washers (Fig. 1346)

ORDERING INFO				TECH INFO
Dealer Pkg. 5 Cards	OEM Bulk Pkg. 50 Pcs.	Screw Size	Ship Wt. Carton Lbs. DP/OEM Bulk	Length Overall: 6-1/4" Length Inside: 3-1/2" Height Inside: 1"
2 Pcs. per Card 1336DPOCHR	1336000CHR	1/4	6.4/30.2	
Std. Pkg. - 1 Pc. OEM Bulk Pkg. - 50 Pcs.	Stud Size	Ship Wt. Carton Lbs. Std. Pkg./OEM Bulk		
1346000CHR	1/4-20 x 1-1/2	0.8/38.0		



Fig. 1336

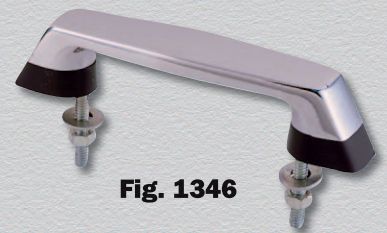

Fig. 1346

8

Fig. 1222 - Handle

CONSTRUCTION:

- Chrome Plated Zinc Alloy

ORDERING INFO			TECH INFO
Dealer Pkg. 5 Cards	OEM Bulk Pkg. 100 Pcs.	Ship Wt. Carton Lbs. DP/OEM Bulk	Length Overall: 5-3/4" Length Inside: 3-5/8" Height Inside: 1-1/4" Screw Size: #8
2 Pcs. per Card 1222DPOCHR	1222000CHR	3.2/23.5	



Fig. 1222



Fig. 1231 - Handle

CONSTRUCTION:

- Chrome Plated Zinc Alloy

ORDERING INFO			TECH INFO
Dealer Pkg. 5 Cards	OEM Bulk Pkg. 50 Pcs.	Ship Wt. Carton Lbs. DP/OEM Bulk	Length Overall: 6" Length Inside: 3-1/2" Height Inside: 1-5/16" Screw Size: 1/4
2 Pcs. per Card 1231DPOCHR	1231000CHR	4.8/19.8	



Fig. 1231

Fig. 0775 - Handle

CONSTRUCTION:

- Chrome Plated Bronze

ORDERING & TECH INFO						
Length Overall Inches	Length Inside Inches	Height Inside Inches	Dealer Pkg. 5 Cards	OEM Bulk Pkg. 50 Pcs.	Screw Size	Ship Wt. Carton Lbs. DP/OEM Bulk
4-1/4	2-1/2	7/8	0775DP1CHR	0775001CHR	6	1.8/7.2
5-3/4	3-5/8	1-3/8	0775DP2CHR	0775002CHR	8	3.1/11.2



Fig. 0775

FLAG POLE SOCKETS & FLAG STAFF



Figs. 0218 & 0219 - Flush Flag Pole Sockets

CONSTRUCTION:

- Chrome Plated Bronze

ALSO AVAILABLE IN
MARINIUM
Contact Factory

Fig. 0218 - Straight Bow Socket
Fig. 0219 - 26° Angle Stern Socket

Fig. 0218 Bow

Fig. 0219 Stern

ORDERING & TECH INFO

I.D. Socket Inches	O.D. Flange Inches	Depth Socket Inches	Straight Dealer Pkg. - 5 Cds 1 Pc. per Card	Straight OEM Bulk Pkg. 5 Pcs.	Angled Dealer Pkg. - 5 Cds. 1 Pc. per Card	Angled OEM Bulk Pkg. 5 Pcs.	Screw Size	Ship Wt. Carton Lbs. 0218/0219
3/4	2	1-1/2	0218DP1CHR	0218001CHR	0219DP1CHR	0219001CHR	8	2.0/3.4
1	2-3/8	1-3/4	0218DP2CHR	0218002CHR	0219DP2CHR	0219002CHR	8	3.4/3.7
1-1/4	2-5/8	2	0218DP3CHR	0218003CHR	0219DP3CHR	0219003CHR	8	4.0/4.8

8



Fig. 0220 Bow

Fig. 0221 Stern

Figs. 0220 & 0221 - Upright Flag Pole Sockets

CONSTRUCTION:

- Chrome Plated Bronze

Fig. 0220 - Straight Bow Socket
Fig. 0221 - 13° Angle Stern Socket

ALSO AVAILABLE IN
MARINIUM
Contact Factory



ORDERING & TECH INFO

I.D. Socket Inches	O.D. Base Inches	Height Overall Inches	Straight DP Pkg. - 5 Cds. 1 Pc. per Card	Angled DP Pkg. - 5 Cds. 1 Pc. per Card	Screw Size	Ship Wt. Carton Lbs. 0220/0221
3/4	2-1/8	1-3/4	0220DP1CHR	0221DP1CHR	8	1.7/2.0
1	2-1/2	2	0220DP2CHR	0221DP2CHR	8	3.1/3.7
1-1/4	2-3/4	2-1/8	0220DP3CHR	0221DP3CHR	8	3.1/4.5

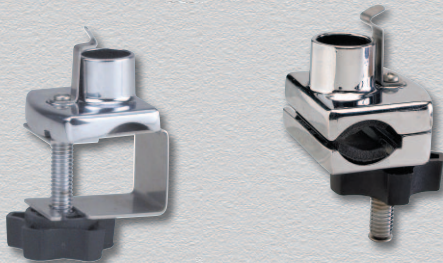

Fig. 1322

Fig. 1302

Figs. 1302 & 1322 - Clamp-On Flag Pole Sockets

CONSTRUCTION:

- Chrome Plated Zinc Alloy With Black Polymer Knob
- Fig. 1302 For Round Rail Sizes 3/4 to 1 Inch**
- Fig. 1322 For Square Rail Size 1-1/4 Inch**

ORDERING & TECH INFO

I.D. Socket Inches	Dimensions Bracket Inches	Dealer Pkg. 5 Cards 1 Pc. per Card	Ship Wt. Carton Lbs. Dealer Pkg.
3/4	2 x 1-3/4	1302DPOCHR	3.5
3/4	2 x 1-3/4	1322DPOCHR	2.8

Fig. 0495 - Flag Staff

CONSTRUCTION:

- Chrome Plated Zinc Alloy Base and Top
- Anodized Aluminum Tube

Sizes 2 and 3 For Use With
Figs. 1302 & 1322 Clamp-On Sockets Only

Fig. 0495



ORDERING & TECH INFO

O.D. Base Inches	Length Overall Inches	Dealer Pkg. 5 Bags 1 Pc. per Bag	Ship Wt. Carton Lbs. Dealer Pkg.
1/2	14	0495DP1CHR	1.5
3/4	14	0495DP2CHR	1.7
3/4	18	0495DP3CHR	2.0

Figs. 0427, 0428, 1277, 1278, 1304 & 1327 Flag Poles & Sockets**CONSTRUCTION:**

- **Fig. 0427** - Chrome Plated Brass Pole, Chrome Plated Bronze Straight Socket
- **Fig. 0428** - Chrome Plated Brass Pole, Chrome Plated Bronze Angled Socket
- **Fig. 1277** - Aluminum Pole, Chrome Plated Zinc Alloy Straight Socket
- **Fig. 1278** - Aluminum Pole, Chrome Plated Zinc Alloy Angled Tear Drop Socket
- **Fig. 1304** - Aluminum Pole, Chrome Plated Zinc Alloy Clamp-on Socket for 3/4" to 1" Round Rails
- **Fig. 1327** - Aluminum Pole, Chrome Plated Zinc Alloy Clamp-on Socket for 1-1/4" Square Rails
- DP3 Version Includes **Made in the U.S.A. Embroidered American Flag** in each Package
- For 16 Inch High Flags
- Includes Allen Wrench and Thumb Screw for Easy Disassembly of Pole and Socket

**ORDERING & TECH INFO**

Description	Base Style	Finish	Dealer Pkg. 5 Cards 1 Pc. per Card	I.D. Socket Inches	Approx. Pole Ht. Inches	Ship Wt. Carton Lbs. Dealer Pkg.
Pole & Socket	Straight	Chr. Brass/Chr. Bronze	0427DP2CHR	3/4	31-1/2	9.8
Pole & Socket	Straight	Alum./Chr. Zinc Alloy	1277DP2CHR	1/2	31-1/2	7.2
Pole & Socket	Angled	Chr. Brass/Chr. Bronze	0428DP2CHR	3/4	31-1/2	9.0
Pole & Socket	Angled	Alum./Chr. Zinc Alloy	1278DP2CHR	1/2	31-1/2	7.3
Pole & Socket	Clamp On (Round)	Alum./Chr. Zinc Alloy	1304DP2CHR	3/4	18	6.1
Pole & Socket	Clamp On (Square)	Alum./Chr. Zinc Alloy	1327DP2CHR	3/4	18	5.4
Pole, Socket & Flag	Straight	Chr. Brass/Chr. Bronze	0427DP3CHR	3/4	31-1/2	10.5
Pole, Socket & Flag	Straight	Alum./Chr. Zinc Alloy	1277DP3CHR	1/2	31-1/2	9.0
Pole, Socket & Flag	Angled	Chr. Brass/Chr. Bronze	0428DP3CHR	3/4	31-1/2	10.5
Pole, Socket & Flag	Angled	Alum./Chr. Zinc Alloy	1278DP3CHR	1/2	31-1/2	9.3
Pole, Socket & Flag	Clamp On (Round)	Alum./Chr. Zinc Alloy	1304DP3CHR	3/4	18	7.7
Pole, Socket & Flag	Clamp On (Square)	Alum./Chr. Zinc Alloy	1327DP3CHR	3/4	18	7.1

GRAB RAIL POSTS, BOAT HOOK HOLDERS, POLE STORAGE CLIPS & SPRING CLAMPS



Fig. 0380
End Post

Fig. 0380A
Center Post

Figs. 0380 & 0380A - Grab Rail Posts

CONSTRUCTION:

- Chrome Plated Bronze
- Hollow, For 1 Inch O.D. Tubing

ORDERING INFO		TECH INFO
Standard Pkg. - 1 Pc. 0380000CHR 0380A00CHR	Ship Wt. Carton Lbs. Standard Pkg. 0.8 0.7	Height Overall: 3-3/8" O.D. Base: 2-1/2" Screw Size: #8



Fig. 0492

Fig. 0492 - Boat Hook Holders

CONSTRUCTION:

- Stainless Steel

ORDERING INFO			TECH INFO
Dealer Pkg. 10 Cards 1 Pair per Card 0492DPOSTS	OEM Bulk Pkg. 50 Pairs 0492000STS	Ship Wt. Carton Lbs. DP/OEM Bulk 2.1/8.0	Max. Pole O.D.: 1-1/2" Length: 3-1/2" Width: 1" Screw Size: #6



Fig. 0477

Fig. 0477 - Pole Storage Clips

CONSTRUCTION:

- Soft Black or White Polymer, U.V. Stabilized
- Fits 3/4 or 7/8 Inch Diameter Tubing

ORDERING INFO					TECH INFO
Color	For Pole Size O.D. Inches	Dealer Pkg. 10 Cards 1 Pair per Card	OEM Bulk Pkg. 50 Pairs	Ship Wt. Carton Lbs. DP/OEM Bulk	Dimensions: 3/4" x 2-1/4" x 1-5/8" Screw Size: #10 P.H.
Black	3/4	0477DP0BLK	0477000BLK	1.5/4.3	
White	3/4	0477DP0WHT	0477000WHT	1.5/4.3	
Black	7/8	0477DP1BLK	0477001BLK	1.7/4.5	



Fig. 0502

Fig. 0502 - Spring Clamps

CONSTRUCTION:

- Stainless Steel

ORDERING & TECH INFO							
Min. I.D. Inches	Max. I.D. Inches	Projection Inches	Width Clamp Inches	Dealer Pkg. 10 Cards 1 Pair per Cd.	OEM Bulk Pkg. 50 Pairs	Screw Size	Ship Wt. Carton Lbs. DP/OEM Bulk
5/8	1-1/4	1-1/2	1/2	0502DP1STS	0502001STS	6	1.0/2.9
1	1-3/4	2-1/4	5/8	0502DP2STS	0502002STS	6	1.8/6.8

WINDSHIELD WIPER, ROPE CLAMP & DOCK LINE SPRING

Fig. 0533 - Hand Windshield Wiper

CONSTRUCTION:

- Chrome Plated Zinc Alloy
- For Straight and Curved Windshields
- Arm is Extendable from 8-1/4 to 12 Inches
- Length Overall is 15 to 19 Inches
- Spring Tension is Adjustable
- 400 Series Stainless Steel Arm and Blade Holder

ORDERING & TECH INFO

O.D. Shaft Inches	Max. Thickness of Panel Inches	Length Handle Inches	Length Blade Inches	Dealer Pkg. 5 Pcs. 1 Pc. per Card	Ship Wt. Carton Lbs. Dealer Pkg.
3/8	1-1/8	2-3/8	12	0533DPOSTS	4.1

SPARE PARTS ORDERING INFORMATION

Arm: 053300099A
Curved Blade: 053300099B
Handle: 053300099D



Fig. 0533

8

Fig. 1226 - Rope Clamp

CONSTRUCTION:

- Chrome Plated Zinc Alloy
- For 1/8 or 3/16 Inch Rope



Fig. 1226

ORDERING & TECH INFO

Length Overall Inches	Width Inches	Dealer Pkg. - 25 Cards 2 Pcs. per Card	OEM Bulk Pkg. 100 Pcs.	Ship Wt. Carton Lbs. DP/OEM Bulk
1-1/4	11/16	1226DP0CHR	1226000CHR	4.1/6.4

Fig. 0759 - Dock Line Spring

CONSTRUCTION:

- Galvanized Spring Steel



Fig. 0759

ORDERING & TECH INFO

For Rope Size Inches	Length Overall Inches	O.D. Inches	Compression Inches	Standard Package - 5 Pcs.	Ship Wt. Carton Lbs. Standard. Pkg.
1/2	10	1-1/2	4-1/2	0759001ZNC	4.7

PERKO® ROPE PULLEYS & ROPE GUIDES



Fig. 0565

Fig. 0565 - Swivel Rope Pulley

CONSTRUCTION:

- Stainless Steel with Strap
- White Polymer Sheave
- Maximum Rope Size 1/4 Inch

ORDERING & TECH INFO

O.D. Sheave Inches	Length Overall Inches	Length Strap Inches	Dealer Pkg. - 5 Cards 2 Pcs. per Card	Screw Size	Ship Wt. Carton Lbs. Dealer Pkg.
2-5/16	3-3/4	1-5/8	0565DP	10	1.7

8



Fig. 0634

Fig. 0634 - Swivel Snap Hook Rope Pulley

CONSTRUCTION:

- Stainless Steel
- White Polymer Sheave
- Maximum Rope Size 1/4 Inch

ORDERING & TECH INFO

O.D. Sheave Inches	Length Overall Inches	Opening Snap Throat Inches	Dealer Pkg. - 5 Cards 2 Pcs. per Card	Ship Wt. Carton Lbs. Dealer Pkg.
2-5/16	4-5/8	1/2	0634DP	2.0



Fig. 1243

Fig. 1243 - Rope Guide

Construction:

- Chrome Plated Zinc Alloy
- Black Polymer Sheave

ORDERING & TECH INFO

Maximum Rope Size Inches	O.D. Sheave Inches	Dimensions Base Inches	Dealer Pkg. 10 Cards 1 Pc. per Card	Screw Size	Ship Wt. Carton Lbs. Dealer Pkg.
1/4	7/8	2 x 3/4	1243DPOCHR	8	1.5

Figs. 1256 & 1261 - Rope Guides

CONSTRUCTION:

- Chrome Plated Zinc Alloy



Fig. 1261



Fig. 1256

ORDERING & TECH INFO

I.D. Hole Inches	Dimensions Base Inches	Dealer Pkg. 25 Cards 2 Pcs. per Card	OEM Bulk Pkg. 100 Pcs.	Screw Size	Ship Wt. Carton Lbs. DP/OEM Bulk
5/16	1-1/4 x 3/4	1256DPOCHR	1256000CHR	6	2.5/3.0
5/16	1-1/4 x 3/4	1261DPOCHR	1261000CHR	6	2.5/2.9

FENDER LOCK, HOOKS & EYE SNAP

Fig. 1299 - Fender Lock

CONSTRUCTION:

- Chrome Plated Zinc Alloy

The Eye is to be Permanently Attached to the Fender Line.



Fig. 1299

ORDERING & TECH INFO

I.D. Eye Inches	O.D. Flange Inches	Dealer Pkg. 10 Cards 2 Pcs. per Card	OEM Bulk Pkg. 50 Pcs.	Screw Size	Ship Wt. Carton Lbs. DP/OEM Bulk
3/8	1-1/2	1299DP0CHR	1299000CHR	8	1.6/2.9

Spare Eye (2 per Card): 1299DP099A.

8

Fig. 1246 - Fender Hook

CONSTRUCTION:

- Chrome Plated Zinc Alloy



Fig. 1246

ORDERING & TECH INFO

Maximum Rope Size Inches	Dimensions Plate Inches	Dealer Pkg. - 10 Cards 2 Pcs. per Card	Screw Size	Ship Wt. Carton Lbs. Dealer Pkg.
3/8	1-3/4 x 1-1/4	1246DP0CHR	6	2.1

Fig. 1309 - Snap Type Fender Hook

CONSTRUCTION:

- Chrome Plated Zinc Alloy



Fig. 1309

ORDERING & TECH INFO

Maximum Rope Size Inches	Dimensions Plate Inches	Dealer Pkg. 10 Cards 2 Pcs. per Card	OEM Bulk Pkg. 100 Pcs.	Screw Size	Ship Wt. Carton Lbs. DP/OEM Bulk
1/4	1-9/16 x 1-3/8	1309DP0CHR	1309000CHR	6	2.1/8.4

Fig. 1289 - Swivel Eye Snap

CONSTRUCTION:

- Chrome Plated Zinc Alloy
- Interlocking Tongue

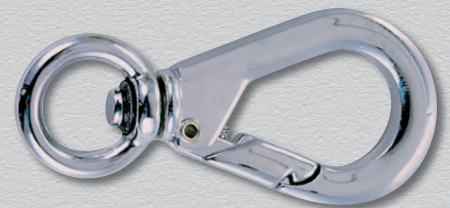

Fig. 1289

ORDERING & TECH INFO

I.D. Eye Inches	Length Overall Inches	Dealer Pkg. - 10 Cards 1 Pc. per Card	Ship Wt. Carton Lbs. Dealer Pkg.
5/8	3	1289DP0CHR	2.0

Fig. 1227 - North River Type Rowlock Horns



Fig. 1227

CONSTRUCTION:

- Plain or Chrome Plated Zinc Alloy

ORDERING & TECH INFO

Finish	O.D. Shank Inches	Length Shank Inches	Between Horns Inches	Dealer Pkg. 10 Cards 1 Pair per Card	Ship Wt. Carton Lbs. Dealer Pkg.
Plain	1/2	1-3/4	1-3/4	1227DPOZNC	6.0
Chrome	1/2	1-3/4	1-3/4	1227DPOCHR	6.3

8

Fig. 1262 - Ribbed Type Rowlock Horns



Fig. 1262

CONSTRUCTION:

- Plain or Chrome Plated Zinc Alloy

ORDERING & TECH INFO

Finish	O.D. Shank Inches	Length Shank Inches	Between Horns Inches	Dealer Pkg. 10 Cards 1 Pair per Card	Ship Wt. Carton Lbs. Dealer Pkg.
Plain	1/2	1-3/4	1-3/4	1262DPOZNC	5.8
Chrome	1/2	1-3/4	1-3/4	1262DPOCHR	5.9



Fig. 1267 - Round Type Rowlock Horns



Fig. 1267

CONSTRUCTION:

- Plain or Chrome Plated Zinc Alloy

ORDERING & TECH INFO

Finish	O.D. Shank Inches	Length Shank Inches	I.D. Horns Inches	Dealer Pkg. 10 Cards 1 Pair per Card	Ship Wt. Carton Lbs. Dealer Pkg.
Plain	1/2	1-3/4	2	1267DPOZNC	6.8
Chrome	1/2	1-3/4	2	1267DPOCHR	6.8

ROWLOCK SOCKETS, OAR LEATHERS & BUTTONS

Fig. 1185 - Top Mount Rowlock Sockets

CONSTRUCTION:

- Plain or Chrome Plated Zinc Alloy
- Black Polymer Bearings
- For Use with Fig. 1227, 1262 or 1267 Rowlock Horns



Fig. 1185

ORDERING & TECH INFO

Finish	Length Inches	Width Inches	Depth Inches	Dealer Pkg.	OEM	Ship Wt.
				10 Cards 1 Pair per Card	Bulk Pkg. 50 Pairs	Carton Lbs. DP/OEM Bulk
Plain	2-7/8	1-1/8	1-1/8	1185DPOZNC	1185000ZNC	4.0/17.0
Chrome	2-7/8	1-1/8	1-1/8	1185DPOCHR	1185000CHR	4.0/17.0

Screw Size #10. Polymer Bearing: 1155000BLK.



Fig. 1186 - Edge Mount Rowlock Sockets

CONSTRUCTION:

- Plain or Chrome Plated Zinc Alloy
- Black Polymer Bearings
- For Use with Fig. 1227, 1262 or 1267 Rowlock Horns



Fig. 1186

ORDERING & TECH INFO

Finish	Length Inches	Width Inches	Depth Inches	Dealer Pkg.	Ship Wt.
				10 Cards 1 Pair per Card	Carton Lbs. Dealer Pkg.
Plain	4	7/8	1-1/8	1186DPOZNC	7.0
Chrome	4	7/8	1-1/8	1186DPOCHR	7.2

Screw Size #10. Polymer Bearing: 1155000BLK.



Fig. 1187 - Side Mount Rowlock Sockets

CONSTRUCTION:

- Plain or Chrome Plated Zinc Alloy
- Black Polymer Bearings
- For Use with Fig. 1227, 1262 or 1267 Rowlock Horns



Fig. 1187

ORDERING & TECH INFO

Finish	Length Inches	Depth Inches	Dealer Pkg. - 10 Cards	Ship Wt.
			1 Pair per Card	Carton Lbs. Dealer Pkg.
Plain	4	1-1/4	1187DPOZNC	4.3
Chrome	4	1-1/4	1187DPOCHR	4.4

Screw Size #10. Polymer Bearing: 1155000BLK.

Fig. 0233 - Oar Leathers & Buttons

CONSTRUCTION:

- Leather



Fig. 0233

ORDERING & TECH INFO

Dimensions Leather Inches	Dimensions Button Inches	Dealer Pkg. 5 Cards 1 Pair per Card	Ship Wt. Carton Lbs. Dealer Pkg.
7 x 6-1/2	1/2 x 13	0233DP1	2.3

Note: Pair Consists of 2 Leathers and 2 Buttons.

PERKO® ROWLOCK HORNS & SOCKETS



Fig. 0828

Fig. 0828 - Ribbed Type Rowlock Horns

CONSTRUCTION:

- Plain Manganese Bronze

ORDERING & TECH INFO

O.D. Shank Inches*	Length Shank Inches	Between Horns Inches	Dealer Pkg. - 5 Cards 1 Pair per Card	Ship Wt. Carton Lbs. Dealer Pkg.
1/2	2-1/8	2	0828DPOPLB	5.0

8



Fig. 0829

Fig. 0829 - Round Type Rowlock Horns

CONSTRUCTION:

- Plain Manganese Bronze

ORDERING & TECH INFO

O.D. Shank Inches*	Length Shank Inches	I.D. Horn Inches	Dealer Pkg. - 5 Cards 1 Pair per Card	Ship Wt. Carton Lbs. Dealer Pkg.
1/2	2-1/8	2	0829DPOPLB	5.0
1/2	2-1/8	2-1/4	0829DP1PLB	5.8



Fig. 0830

Fig. 0830 - North River Type Rowlock Horns

CONSTRUCTION:

- Plain Manganese Bronze

ORDERING & TECH INFO

O.D. Shank Inches*	Length Shank Inches	Between Horns Inches	Dealer Pkg. - 5 Cards 1 Pair per Card	Ship Wt. Carton Lbs. Dealer Pkg.
1/2	2-1/8	2-1/8	0830DPOPLB	4.3



Fig. 0831



Fig. 0832



Fig. 0833

Figs. 0831, 0832 & 0833 - Rowlock Sockets

CONSTRUCTION:

- Plain Manganese Bronze

ORDERING & TECH INFO

Mount	Length Inches	Width Inches	Depth Inches	Dealer Pkg. 5 Cards 1 Pair per Card	Ship Wt. Carton Lbs. Dealer Pkg.
Top	2-3/8	7/8	1	0831DPOPLB	2.4
Side	3-5/8	—	1-3/8	0832DPOPLB	2.5
Edge	4	3/4	1-3/4	0833DPOPLB	3.7

Screw Size #10.

*Note: The Plain Bronze Oarlocks listed on this page were designed for use only with the matching plain bronze rowlock sockets Figs. 0831-0833.

HATCH FASTENERS OR WINDSHIELD KEEPERS

Fig. 0769 - Hatch Fastener or Windshield Keeper

CONSTRUCTION:

- Chrome Plated Brass and Zinc Alloy
- Black Polymer Handle

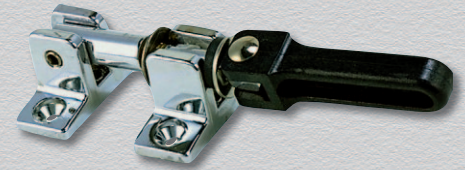

Fig. 0769

ORDERING & TECH INFO

Dimensions Base Inches	Dealer Pkg. 5 Cards 1 Pc. per Card	OEM Bulk Pkg. 25 Pcs.	Screw Size	Ship Wt. Carton Lbs. DP/OEM Bulk
1-1/2 x 5/8	0769DPOCHR	0769000CHR	8	1.5/5.9

SPARE PARTS ORDERING INFORMATION

Keeper: 076900099A

Handle with Stud: 076900099C

Fig. 0697 - Hatch Fastener or Windshield Keeper

CONSTRUCTION:

- Chrome Plated Brass and Zinc Alloy



Fig. 0697

ORDERING & TECH INFO

Length Bolt Inches	Dimensions Bracket Inches	Dimensions Keeper Inches	Dealer Pkg. 10 Cards 1 Pc. per Card	Screw Size	Ship Wt. Carton Lbs. Dealer Pkg.
1-1/2	1-1/2 x 5/8	1-1/2 x 3/4	0697DPOCHR	8	2.2

Fig. 0967 - Hatch Fastener or Windshield Keeper

CONSTRUCTION:

- Chrome Plated Bronze

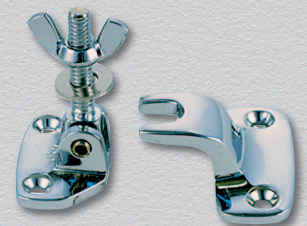

Fig. 0967

ORDERING & TECH INFO

Length Bolt Inches	Dimensions Bracket Inches	Dimensions Keeper Inches	Dealer Pkg. 5 Cards 1 Pc. per Card	OEM Bulk Pkg. 25 Pcs.	Screw Size	Ship Wt. Carton Lbs. DP/OEM Bulk
1-1/2	1-9/16 x 1	1-7/8 x 7/8	0967DPOCHR	0967000CHR	8	1.4/6.0

Fig. 0770 - Hatch Fastener

CONSTRUCTION:

- Chrome Plated Bronze
- Black Polymer Knob

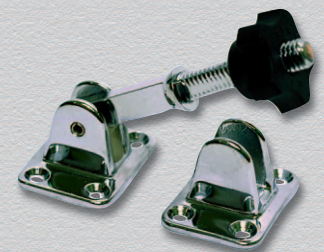

Fig. 0770

ORDERING & TECH INFO

Dimensions Overall Inches	Adjustment Thread Inches	Dealer Pkg. 5 Cards 1 Pc. per Card	OEM Bulk Pkg. 25 Pcs.	Screw Size	Ship Wt. Carton Lbs. DP/OEM Bulk
3-1/2 x 1-5/8	7/8	0770DPOCHR	0770000CHR	8	2.3/10.0

HATCH ADJUSTER, BRACES & FASTENER



Fig. 0797

Fig. 0797 - Hatch Adjuster

CONSTRUCTION:

- Chrome Plated Brass and Zinc Alloy
- Black Polymer Knob

ORDERING & TECH INFO

Length Arm Inches	Length Adjustment Inches	Length Slide Inches	Dealer Pkg. 5 Cards 1 Pc. per Card	Screw Size	Ship Wt. Carton Lbs. Dealer Pkg.
10	9-1/2	10-3/4	0797DPOCHR	8	4.3

8



Fig. 0762

Fig. 0762 - Hatch Support Braces

CONSTRUCTION:

- Chrome Plated Brass
- One End Angled Base, the Other End Flat Base

ORDERING & TECH INFO

Length Open Inches	Dealer Pkg. - 5 Cards 1 Pair per Card	OEM Bulk Pkg. 20 Pairs	Screw Size	Ship Wt. Carton Lbs. DP/OEM Bulk
10	0762DP1CHR	0762001CHR	8	4.0/13.9
12	0762DP2CHR	0762002CHR	8	4.4/15.5
14	0762DP3CHR	0762003CHR	8	5.0/16.2

NOTE: Illustration is Port Side

NEW Item



Fig. 0763

Fig. 0763 - Hatch Support Braces

CONSTRUCTION:

- Chrome Plated Brass
- Both Ends Angled Base

ORDERING & TECH INFO

Length Open Inches	OEM Bulk Pkg. 20 Pairs	Screw Size	Ship Wt. Carton Lbs. OEM Bulk
10	0763001CHR	8	13.9
12	0763002CHR	8	15.5
14	0763003CHR	8	16.2

NOTE: Illustration is Port Side.



Fig. 0155

Fig. 0155 - Hatch Fastener or Windshield Keeper

Construction:

- Chrome Plated Brass and Zinc Alloy
- Phosphor Bronze Spring

ORDERING & TECH INFO

Length Overall Inches	Mounting Base Inches	Dealer Pkg. 5 Cards 1 Pc. per Card	OEM Bulk Pkg. 50 Pcs.	Screw Size	Ship Wt. Carton Lbs. DP/OEM Bulk
3-7/8	1-1/2 x 9/16	0155DPOCHR	0155000CHR	6	1.4/10.8

PERKO® WINDSHIELD ADJUSTERS

Figs. 1179 & 1180 - Windshield Adjusters

CONSTRUCTION:

- Chrome Plated Brass and Zinc Alloy
- Black Polymer Knob



Fig. 1179



Fig. 1180

ORDERING & TECH INFO

Length Closed Inches	Length Open Inches	O.D. Tube Inches	Dealer Pkg. 5 Cards 1 Pc. per Card	OEM Bulk Pkg. 20 Pcs.	Screw Size	Ship Wt. Carton Lbs. DP/OEM Bulk
10	18	1/2	1179DP1CHR	1179001CHR	6	4.0/12.2
12	20	1/2	1179DP2CHR	1179002CHR	6	4.1/12.4
12	21	1/2	1180DPOCHR	1180000CHR	6	4.3/13.4

Knob: 1117DPOBLK

Fig. 1116 - Windshield Adjuster

CONSTRUCTION:

- Chrome Plated Brass and Zinc Alloy
- Black Polymer Knob



Fig. 1116

ORDERING & TECH INFO

Length Rod Inches	O.D. Rod Inches	Dealer Pkg. 5 Cards 1 Pc. per Card	OEM Bulk Pkg. 20 Pcs.	Screw Size	Ship Wt. Carton Lbs. DP/OEM Bulk
8	3/8	1116DP1CHR	1116001CHR	8	3.3/10.0
10	3/8	1116DP2CHR	1116002CHR	8	3.8/11.5
12	3/8	1116DP3CHR	1116003CHR	8	4.1/12.9

Knob: 1117DPOBLK

Figs. 0082, 1290 & 1291 - Windshield Adjusters

CONSTRUCTION:

- Fig 0082 Chrome Plated Brass and Bronze
- Figs 1290 & 1291 Chrome Plated Zinc Alloy
- Black Polymer Knob



Fig. 1290 Side Mount



Fig. 1291 Offset Mount



Fig. 0082 - Offset Mount

Fig. 1290 - Side Mount

Fig. 1291 - Offset Mount

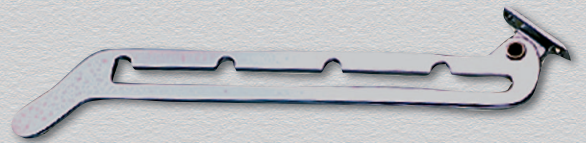

Fig. 0082 Offset Mount

ORDERING & TECH INFO

Length Overall Inches	Length Adjustment Inches	Dealer Pkg. 5 Cards 1 Pair per Card	Std. Pkg. 1 Pair	OEM Bulk Pkg. 10 Pairs	Screw Size	Ship Wt. Carton Lbs. DP/Std/OEM Bulk
12	9-1/2	1290DPOCHR	0082000CHR	1290000CHR	8	6.3/2.7/11.2
12	9-1/2	1291DPOCHR	_____	1291000CHR	8	6.3/-/11.3

SPARE PARTS ORDERING INFORMATION

Figure No.	Port Only	Starboard Only	Mounting Bracket With Knob	Knob Only
1290	1290P0099A	1290S0099A	129000099B	1292000BLK
1291	1291P0099A	1291S0099A	129100099B	1292000BLK
0082	0082P0099B	0082S0099B	_____	008200099A

NOTE: Illustrations are Port Side.

PERKO® AXE BRACKET, RING BUOY HOLDER & EYE STRAPS

Fig. 0325 - Axe Bracket



**Fig. 0325
Socket & Bracket**

CONSTRUCTION:

- Stainless Steel

ORDERING & TECH INFO

For Blade Width Inches	Standard Pkg. - 10 Sets	Socket Screw Size	Bracket Screw Size	Ship Wt. Carton Lbs. Standard Pkg.
6	0325000STS	10 R.H.	6	3.0

Fig. 1017 - Ring Buoy Holder

8



Fig. 1017

CONSTRUCTION:

- Chrome Plated or Plain Brass

ORDERING & TECH INFO

Width Mounting Plate Inches	Height Overall Inches	Chrome Plated Brass Dealer Pkg. - 5 Cards	Plain Brass Standard Pkg. - 5 Pcs.	Screw Size	Ship Wt. Carton Lbs. DP/Std. Pkg.
3	4-1/2	1 Pc. per Card 1017DPOCHR	1017000PLB	8	2.9/2.4

Fig. 1242 - Eye Strap



Fig. 1242

CONSTRUCTION:

- Chrome Plated Zinc Alloy

ORDERING & TECH INFO

Length Overall Inches	I.D. Eye Inches	Dealer Pkg. 10 Cards	OEM Bulk Pkg. 100 Pcs.	Screw Size	Ship Wt. Carton Lbs. DP/OEM Bulk
1-7/8	5/16	5 Pcs. per Card 1242DPOCHR	1242000CHR	8	1.6/2.3

Fig. 0562 - Eye Strap

CONSTRUCTION:

- 300 Series Stainless Steel



Fig. 0562

ORDERING & TECH INFO

Length Overall Inches	I.D. Eye Inches	Dealer Pkg. 10 Cards	OEM Bulk Pkg. 100 Pcs.	Screw Size	Ship Wt. Carton Lbs. DP/OEM Bulk
1-5/8	1/4	5 Pcs. per Card 0562DPOSTS	0562000STS	10	0.9/0.8

**NEW
Item**

Fig. 0771 - Lockable, Adjustable Mount Hold-Down Clamp

Construction:

- Polished Chrome Plated Bronze
- Flat Mounting
- All Mounting Holes Covered in Closed Position

Fig. 0771

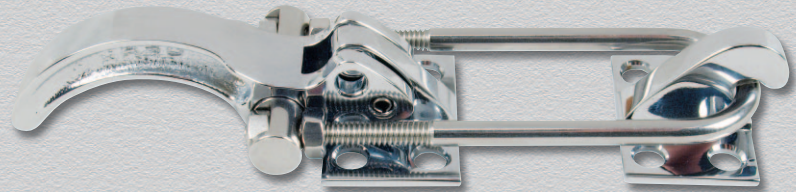

ORDERING & TECH INFO

Overall Length Inches	Width Inches	Adjustable Range Inches	OEM Bulk Pkg. 25 Pcs.	Screw Size	Ship Wt. Carton Lbs. OEM Bulk
8	2	1-11/16	0771000CHR	10	26.5

Fig. 1008 - Lockable, Security Hold-Down Clamp

CONSTRUCTION:

- Chrome Plated Bronze
- All Mounting Holes Covered in Closed Position

**NEW
Item**



Fig. 1008

ORDERING & TECH INFO

Length Closed Inches	Width Overall Inches	Padlock Shank Size Inches	OEM Bulk Pkg. 25 Pcs.	Screw Size	Ship Wt. Carton Lbs. OEM Bulk
4-1/2	3-3/4	1/4	1008000CHR	8	8.4



Fig. 1108 - Lockable Hold-Down Clamp

CONSTRUCTION:

- Chrome Plated Bronze
- Flat Mounting



Fig. 1108

ORDERING & TECH INFO

Dimensions Base Inches	Padlock Shank Size Inches	Dealer Pkg. 5 Cards 1 Pc. per Card	OEM Bulk Pkg. 25 Pcs.	Screw Size	Ship Wt. Carton Lbs. DP/OEM Bulk
2-3/4 x 1-3/4	1/4	1108DPOCHR	1108000CHR	6	2.0/8.4



Fig. 1112 - Flat Mounting Hold-Down Clamp

Fig. 1113 - Right Angle Mount Hold-Down Clamp

Construction:

- Chrome Plated Bronze



Fig. 1112



Fig. 1113

ORDERING & TECH INFO

Length Inches	Width Inches	Dealer Pkg. - 5 Cards 1 Pc. per Card	OEM Bulk Pkg. 25 Pcs.	Screw Size	Ship Wt. Carton Lbs. DP/OEM Bulk
3	1-1/2	1112DPOCHR	1112000CHR	8	2.1/8.8
2-1/2	1-1/2	1113DPOCHR	1113000CHR	8	2.2/9.4



Fig. 1002 - Butt Hinge

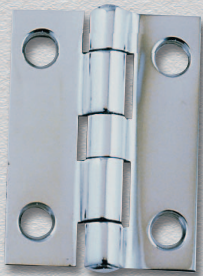
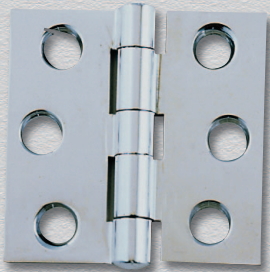

Fig. 1002

CONSTRUCTION:

- Heavy Gauge Extruded Brass
 - Chrome Plated
 - Fast Pin

ORDERING & TECH INFO

Height Pin Inches	Width Open Inches	Dealer Pkg. 1 Pair per Card	Cards Per Pkg.	Std Pkg. Catalog No.	Std. Pkg. Pair	Screw Size	No. of Holes	Ship Wt. Carton Lbs. DP/Std. Pkg.
2	1-1/2	1002003DP	5	1002003CHR	5	6	4	1.2/1.0
2	2	1002004DP	5	1002004CHR	5	6	6	1.6/1.3
3	2	1002007DP	5	1002007CHR	25	8	6	2.2/9.2
3	3	1002009DP	1	1002009CHR	10	10	6	1.2/8.9
4	3	1002012DP	1	1002012CHR	1	10	6	1.5/1.4
4	4	1002013DP	1	1002013CHR	1	1/4	6	2.0/8.7

Fig. 1004 - Butt Hinge

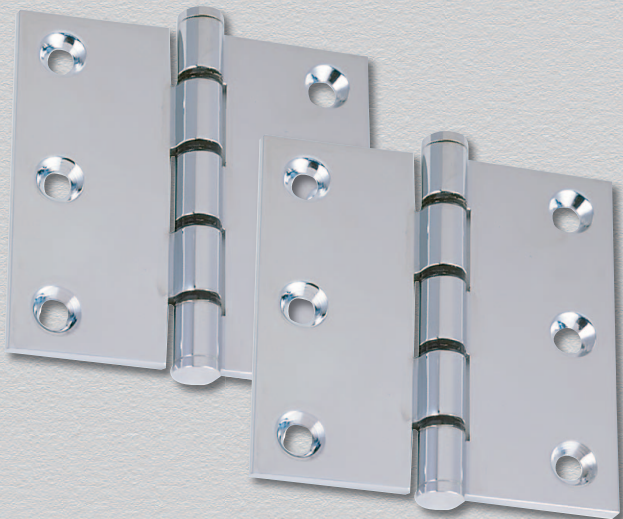

Fig. 1004

CONSTRUCTION:

- Chrome Plated Extruded Brass
- Extra Heavy Duty Polymer Bearings
- Removable Pin

For Transom Doors and Other Applications Where Extra Strength and Smooth Operation are Required

ORDERING & TECH INFO

Height Pin Inches	Width Open Inches	Dealer Pkg. 1 Card 1 Pair per Card	OEM Bulk Pkg. 1 Pair	Screw Size	No. of Holes	Ship Wt. Carton Lbs. DP/OEM Bulk
4	4	1004DPOCHR	1004000CHR	1/4	6	2.0/1.8

Fig. 0952 - Butt Hinge

CONSTRUCTION:

- Heavy Gauge Chrome Plated Stamped Brass or Stainless Steel
- Removable Pin

ORDERING & TECH INFO

Height Pin Inches	Width Open Inches	Dealer Pkg. - 5 Cards 1 Pair per Card	OEM Bulk Pkg. 25 Pairs	Screw Size	No. of Holes	Ship Wt. Carton Lbs. DP/OEM Bulk
Stamped Brass						
1-1/2	1-1/4	0952DP1CHR	_____	6	4	0.9/-
1-1/2	1-1/2	0952DP2CHR	_____	6	4	0.9/-
2	1-1/2	0952DP3CHR	_____	6	4	1.1/-
2	2	0952DP4CHR	_____	6	6	1.3/-
2-1/2	2	0952DP5CHR	0952005CHR	8	6	1.7/6.5
2-1/2	2-1/2	0952DP6CHR	_____	8	6	1.9/-
3	3	0952DP9CHR	0952009CHR	10	6	3.8/16.6
Stainless Steel						
1-1/2	1-1/4	0952DP1STS	_____	6	4	0.8/-
1-1/2	1-1/2	0952DP2STS	_____	6	4	0.8/-
2	1-1/2	0952DP3STS	_____	6	4	1.0/-
2	2	0952DP4STS	_____	6	6	1.2/-
2-1/2	2	0952DP5STS	0952005STS	8	6	1.5/6.5
2-1/2	2-1/2	0952DP6STS	_____	8	6	1.7/-
3	3	0952DP9STS	0952009STS	10	6	3.4/16.5



Fig. 0952

Fig. 0949 - Butt Hinge

CONSTRUCTION:

- Heavy Gauge Chrome Plated Stamped Brass or Stainless Steel
- Fast Pin

ORDERING & TECH INFO

Height Pin Inches	Width Open Inches	Dealer Pkg. 5 Cards 1 Pair per Card	OEM Bulk Pkg. 25 Pairs	Screw Size	No. of Holes	Ship Wt. Carton Lbs. DP/OEM Bulk
Stamped Brass						
1-1/2	1-1/4	0949DP1CHR	_____	6	4	0.9/-
1-1/2	1-1/2	0949DP2CHR	_____	6	4	1.0/-
2	1-1/2	0949DP3CHR	_____	6	4	1.1/-
2	2	0949DP4CHR	0949004CHR	6	6	1.3/5.2
2-1/2	2	0949DP5CHR	_____	8	6	1.7/-
2-1/2	2-1/2	0949DP6CHR	_____	8	6	1.9/-
3	3	0949DP9CHR	0949009CHR	10	6	3.8/16.5
Stainless Steel						
1-1/2	1-1/4	0949DP1STS	_____	6	4	0.8/-
1-1/2	1-1/2	0949DP2STS	_____	6	4	0.9/-
2	1-1/2	0949DP3STS	_____	6	4	1.0/-
2	2	0949DP4STS	0949004STS	6	6	1.0/5.2
2-1/2	2	0949DP5STS	_____	8	6	1.5/-
2-1/2	2-1/2	0949DP6STS	_____	8	6	1.7/-
3	3	0949DP9STS	0949009STS	10	6	3.3/16.5



Fig. 0949

**CAMO
VERSIONS**
Contact The
Factory



Fig. 1293

Fig. 1293 - Butt Hinge

CONSTRUCTION:

- Chrome Plated Zinc Alloy
- Removable Pin

ORDERING & TECH INFO

Height Pin Inches	Width Open Inches	Dealer Pkg. 5 Cards 1 Pair per Card	OEM Bulk Pkg. 25 Pairs	Screw Size	No. of Holes	Ship Wt. Carton Lbs. DP/OEM Bulk
1-1/2	1-1/2	1293DP2CHR	_____	8	4	1.0/-
2	1-1/2	1293DP3CHR	_____	8	4	1.3/-
2	2	1293DP4CHR	1293004CHR*	8	4	1.5/13.0
2-1/2	2	1293DP5CHR	1293005CHR	8	6	2.0/8.2
2-1/2	2-1/2	1293DP6CHR	1293006CHR	8	6	2.0/8.3
3	3	1293DP9CHR	1293009CHR	10	6	3.0/12.1

* OEM Bulk Pkg. - 50 Pairs.

9

Fig. 0941 - Butt Hinge

CONSTRUCTION:

- Chrome Plated Zinc Alloy



Fig. 0941

ORDERING & TECH INFO

Height Pin Inches	Width Open Inches	Dealer Pkg. 5 Cards 1 Pair per Card	OEM Bulk Pkg. 50 Pairs	Screw Size	Ship Wt. Carton Lbs. DP/OEM Bulk
1-1/2	1-1/2	0941DPOCHR	0941000CHR	8	1.1/8.8

Fig. 0951 - Hinge

CONSTRUCTION:

- Chrome Plated Bronze



Fig. 0951

ORDERING & TECH INFO

Width Open Inches	Height Pin Inches	Dealer Pkg. 5 Cards 1 Pair per Card	OEM Bulk Pkg. 25 Pairs	Screw Size	Ship Wt. Carton Lbs. DP/OEM Bulk
3	1-1/2	0951DP1CHR	0951001CHR	8	2.0/8.0
4	1-1/2	0951DP2CHR	0951002CHR	8	2.2/9.3

Fig. 0808 - Hinge

CONSTRUCTION:

- Chrome Plated Zinc Alloy



Fig. 0808

ORDERING & TECH INFO

Width Open Inches	Height Pin Inches	Dealer Pkg. 10 Cards 1 Pair per Card	OEM Bulk Pkg. 50 Pairs	Screw Size	Ship Wt. Carton Lbs. DP/OEM Bulk
3	1-1/2	0808DPOCHR	0808000CHR	8	3.9/16.3

Figs. 0987 & 1213 - Shortside Hinges

CONSTRUCTION:

Fig. 0987 - Chrome Plated Bronze

Fig. 1213 - Chrome Plated Zinc Alloy



Fig. 0987
Chrome Plated Bronze

Fig. 1213
Chrome Plated Zinc Alloy

ORDERING & TECH INFO

Width Open Inches	Height Pin Inches	Width Shortside Inches	Dealer Pkg. 5 Cards 1 Pair per Card	OEM Bulk Pkg. 50 Pairs	Screw Size	Ship Wt. Carton Lbs. DP/OEM Bulk
2-1/4	1-1/2	3/4	0987DP1CHR	0987001CHR	8	1.7/14.0
2-3/4	1-1/2	3/4	0987DP2CHR	—	8	1.9/-
2-1/2	1-1/2	3/4	1213DP1CHR	1213001CHR	8	1.5/12.6

Figs. 0988 & 1214 - Offset Shortside Hinges

CONSTRUCTION:

Fig. 0988 - Chrome Plated Bronze

Fig. 1214 - Chrome Plated Zinc Alloy



Fig. 0988
Chrome Plated Bronze

Fig. 1214
Chrome Plated Zinc Alloy

ORDERING & TECH INFO

Width Open Inches	Height Pin Inches	Width Shortside Inches	Offset Inches	Dealer Pkg. 5 Cards 1 Pair per Card	Screw Size	Ship Wt. Carton Lbs. Dealer Pkg.
2-1/4	1-1/2	3/4	3/8	0988DP1CHR	8	1.8
2-3/4	1-1/2	3/4	3/8	0988DP2CHR	8	1.9
2-1/2	1-1/2	3/4	3/8	1214DP1CHR	8	1.7

Fig. 0999 - Shortside Hinge

CONSTRUCTION:

- Chrome Plated Bronze



Fig. 0999

ORDERING & TECH INFO

Width Open Inches	Height Pin Inches	Width Shortside Inches	Dealer Pkg. 5 Cards 1 Pair per Card	Screw Size	Ship Wt. Carton Lbs. Dealer Pkg.
3-1/2	1-1/2	1-1/2	0999DPOCHR	8	2.0

Fig. 0942 - Offset Hinge

CONSTRUCTION:

- Chrome Plated Zinc Alloy



Fig. 0942

ORDERING & TECH INFO

Width Open Inches	Height Pin Inches	Offset Inches	Dealer Pkg. 5 Cards 1 Pair per Card	OEM Bulk Pkg. 50 Pairs	Screw Size	Ship Wt. Carton Lbs. DP/OEM Bulk
1-1/2	1-1/2	3/8	0942DPOCHR	0942000CHR	8	1.3/10.3



Fig. 0271



Fig. 0272

Fig. 0271 - Inset Hinge
Fig. 0272 - Flush Hinge

CONSTRUCTION:

- Chrome Plated Stamped Brass
- Semi-Concealed

Fig 0271 for 3/8 Inch Inset Doors
Fig 0272 for Overlay Doors

ORDERING & TECH INFO

Dimensions Inches	Dealer Pkg. 10 Cards 1 Pair per Card	OEM Bulk Pkg. 100 Pairs	Screw Size	Ship Wt. Carton Lbs. DP/OEM Bulk
2-3/4 x 2-1/2	0271DPOCHR	0271000CHR	4	2.3/17.2
2-3/4 x 1-7/8	0272DPOCHR	0272000CHR	4	2.0/14.4

9



Fig. 0120

Fig. 0120 - Strap Hinge

CONSTRUCTION:

- Chrome Plated Bronze

ORDERING & TECH INFO

Width Open Inches	Height Pin Inches	Dealer Pkg. 5 Cards 1 Pair per Card	Screw Size	No. of Holes	Ship Wt. Carton Lbs. Dealer Pkg.
4	1-1/8	0120DP1CHR	10	4	2.1
6	1-1/8	0120DP2CHR	10	6	3.0
8	1-3/8	0120DP3CHR	12	6	5.6



Fig. 0197

Fig. 0197 - "T" Hinge

CONSTRUCTION:

- Chrome Plated Bronze

ORDERING & TECH INFO

Width Open Inches	Height Overall Inches	Width "T" Side Inches	Dealer Pkg. 5 Cards 1 Pair per Card	Screw Size	No. of Holes	Ship Wt. Carton Lbs. Dealer Pkg.
4	2-1/8	1-5/16	0197DP1CHR	10	6	2.9
6	3	1-1/2	0197DP2CHR	10	7	5.2
8	3-7/8	2	0197DP3CHR*	12	8	3.5

* Dealer Pkg. - 2 Cards, 1 Pair per Card.



Fig. 0924

Fig. 0924 - Hinge

CONSTRUCTION:

- Chrome Plated Stamped Brass or Stainless Steel

ORDERING & TECH INFO

Material	Width Open Inches	Height Pin Inches	Dealer Pkg. 10 Cards 1 Pair per Card	Screw Size	Ship Wt. Carton Lbs. Dealer Pkg.
Chrome Brass	3	1-1/2	0924DPOCHR	6	2.2
Stainless Steel	3	1-1/2	0924DPOSTS	6	1.0

Fig. 0957 - Non-Mortised Hinge

CONSTRUCTION:

- Chrome Plated Stamped Brass or Stainless Steel
- Easily Installs Without Mortising



Fig. 0957

ORDERING & TECH INFO

Material	Height Pin Inches	Width Closed Inches	Dealer Pkg. 5 Cards 1 Pair per Card	OEM Bulk Pkg. 50 Pairs	Screw Size	Ship Wt. Carton Lbs. DP/OEM Bulk
Chrome Brass	3-3/8	7/8	0957DPOCHR	0957000CHR	8	1.5/12.6
Stainless Steel	3-3/8	7/8	0957DPOSTS	0957000STS	8	1.5/12.1

Figs. 0149 & 0152 - Pull Apart Hinges

CONSTRUCTION:

- Chrome Plated Bronze

Fig. 0149 - Left Hand

Fig. 0152 - Right Hand

Use 2 Left Hand or 2 Right Hand For Quick Removal of Hatches, Motor Covers, etc. or Together (1 each Left & Right) as a Heavy Duty Hinge Set.



Fig. 0152 Right Hand



Fig. 0149 Left Hand

ORDERING INFO

TECH INFO

Dealer Pkg. 5 Cds. 1 Pc. per Card	OEM Bulk Pkg. 25 Pcs.	Ship Wt. Carton Lbs. DP/OEM Bulk Pkg.	Length Open: 3-3/4" Width Overall: 2" Screw Size: #10
0149DPOCHR	0149000CHR	2.0/8.8	
0152DPOCHR	0152000CHR	2.0/8.8	

Fig. 0212 - Continuous Hinge

Fig. 0258 - Hatch Trim

CONSTRUCTION:

- Polished Stainless Steel
- Holes are two inches apart, center to center
- Fig 212 - Countersunk Holes

ORDERING & TECH INFO

Continuous Hinge

Width Open Inches	Dealer Pkg. 5 Pcs. One 24" Lgth./Card	Standard Pkg. 10 Pcs. per Tube in 72" Lengths	Screw Size	Ship Wt. Carton Lbs. DP/Std. Pkg.
1-1/4	0212DP2STS	0212002STS	5	3.2/16.0
1-1/2	0212DP4STS	0212004STS	5	3.7/18.5

Hatch Trim

Width Inches	Length Overall Inches	Standard Pkg. - 10 Pcs.	Screw Size	Ship Wt. Carton Lbs. Std. Pkg.
1-1/4	72	0258002STS	6	11.5
1-1/2	72	0258004STS	6	13.2



Fig. 0212



Fig. 0258

Fig. 0998 - Hasp



Fig. 0998

CONSTRUCTION:

- Chrome Plated Bronze

ORDERING & TECH INFO

Length Closed Inches	Width Overall Inches	Padlock Clearance Inches	Dealer Pkg. 10 Cards 1 Pc. per Card	OEM Bulk Pkg. 25 Pcs.	Screw Size	Ship Wt. Carton Lbs. DP/OEM Bulk
2	1	9/32	0998DP1CHR	0998001CHR	6	1.9/3.9
3	1	9/32	0998DP2CHR	0998002CHR	6	2.0/4.8

SPARE PARTS ORDERING INFORMATION

Chrome Keepers (2 per card): 0959DPOCHR

9

Fig. 1198 - Hasp

CONSTRUCTION:

- Chrome Plated Zinc Alloy

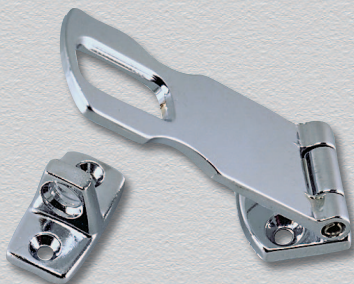

Fig. 1198

ORDERING & TECH INFO

Length Closed Inches	Width Inches	Padlock Clearance Inches	Dealer Pkg. 10 Cards 1 Pc. per Card	OEM Bulk Pkg. 25 Pcs.	Screw Size	Ship Wt. Carton Lbs. DP/OEM Bulk
2	1	1/4	1198DP1CHR	1198001CHR	6	1.6/2.9
3	1	1/4	1198DP2CHR	1198002CHR	6	1.8/3.5
3-3/4	1	1/4	1198DP3CHR	1198003CHR	6	2.0/3.9

SPARE PARTS ORDERING INFORMATION

Keepers (2 per card): 1261DPOCHR



Fig. 1194 - Swivel Eye Hasp

CONSTRUCTION:

- Chrome Plated Zinc Alloy
- Padlock Eye Swivels to Act as a Latch

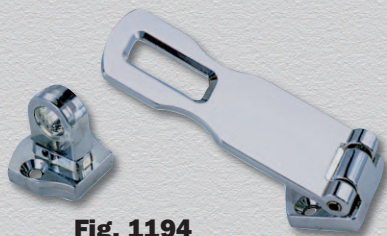

Fig. 1194

ORDERING & TECH INFO

Length Closed Inches	Width Inches	Padlock Clearance Inches	Dealer Pkg. 10 Cards 1 Pc. per Card	OEM Bulk Pkg. 50 Pcs.	Screw Size	Ship Wt. Carton Lbs. DP/OEM Bulk
3	1	11/32	1194DPOCHR	1194000CHR	6	2.0/7.7

SPARE PARTS ORDERING INFORMATION

Keeper (1 per card): 1194DP099A

PERKO® BARREL BOLTS & SHIP BOLT

**NEW
Item**

Fig. 1353 - Slim Barrel Bolt - Visible Mounting Holes
Fig. 1354 - Slim Barrel Bolt - Hidden Mounting Holes

CONSTRUCTION:

- Chrome Plated Zinc Alloy
- Integral Friction Pad Eliminates Rattle and Provides Smooth Operation

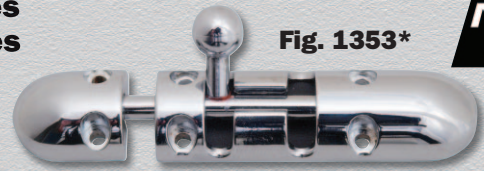

Fig. 1353*



Fig. 1354

ORDERING & TECH INFO

Dimensions Overall Inches	Dealer Pkg. - 5 Cards 1 Pc. per Card	OEM Bulk Pkg. 25 Pcs.	Screw Size	Ship Wt. Carton Lbs. DP/OEM Bulk
3-3/4 x 3/4	1353DPOCHR	1353000CHR	6	1.0/3.9
3-3/4 x 3/4	1354DPOCHR	1354000CHR	6	1.0/3.9

Fig. 1244 - Barrel Bolt

CONSTRUCTION:

- Chrome Plated Zinc Alloy
- Integral Friction Pad Eliminates Rattle and Provides Smooth Operation

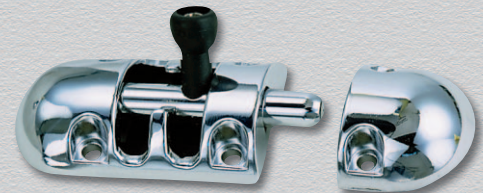

Fig. 1244

ORDERING & TECH INFO

Dimensions Overall Inches	Dealer Pkg. - 5 Cards 1 Pc. per Card	OEM Bulk Pkg. 25 Pcs.	Screw Size	Ship Wt. Carton Lbs. DP/OEM Bulk
3-3/8 x 1-1/4	1244DPOCHR	1244000CHR	6 R.H.	1.2/4.5

Fig. 0947 - Barrel Bolt

CONSTRUCTION:

- Chrome Plated Bronze Body & High Impact Black Nylon Bulkhead Keeper
- 3/8" Diameter Bolt
- Bulkhead Keeper Easily Installs in a 5/8" Hole
- Includes Friction Pad to Eliminate Rattle and Provide Smooth Operation

Dealer Package Includes Both Styles of Keepers.

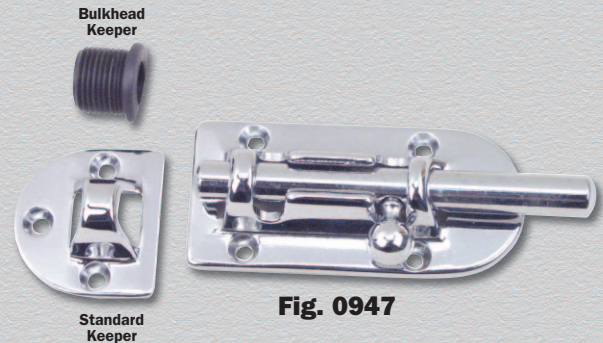

Fig. 0947

ORDERING & TECH INFO

Dimensions Overall Inches	Dealer Pkg. - 5 Cards 1 Pc. per Card	Std. Keeper OEM Bulk Pkg. 25 Pcs.	Bulkhead Keeper OEM Bulk Pkg. 25 Pcs.	Screw Size	Ship Wt. Carton Lbs. DP/OEM Bulk Std/Bulkhead
3-7/16 x 1-7/16	0947DP1CHR	0947001CHR	0947B01CHR	6	1.8/7.0/5.5
4-5/16 x 1-7/16	0947DP2CHR	0947002CHR	0947B02CHR	6	2.1/9.0/7.6
5-1/4 x 1-7/16	0947DP3CHR	0947003CHR	0947B03CHR	6	2.5/10.6/9.4

Fig. 1053 - Ship Bolt

CONSTRUCTION:

- Chrome Plated Bronze
- Included with Brass Friction Spring to Eliminate Rattle and Provide Detented Operation



Fig. 1053

ORDERING & TECH INFO

Dimensions Overall Inches	Dealer Pkg. - 5 Cards 1 Pc. per Card	OEM Bulk Pkg. 25 Pcs.	Screw Size	Ship Wt. Carton Lbs. DP/OEM Bulk
2-5/8 x 1-1/4	1053DPOCHR	1053000CHR	6	1.1/4.1

CABIN DOOR HOOKS



Fig. 0956



**Fig. 0959
Spare Keeper Only**

Fig. 0956 - Cabin Door Hook

CONSTRUCTION:

- Cast Bronze
- Plain or Chrome Plated

ORDERING & TECH INFO

Length Hook Inches	Chrome Plated Bronze Dealer Pkg. - 5 Cards 1 Pc. per Card	Chrome Plated Bronze OEM Bulk Pkg. 50 Pcs.	Plain Bronze Standard Pkg. - 5 Pcs.	Ship Wt. Carton Lbs. DP/OEM Bulk/Std.Pkg.
1-1/2	0956DP1CHR	0956001CHR	0956001PLB	0.9/5.4/0.6
2	0956DP2CHR	0956002CHR	0956002PLB	0.9/5.8/0.7
2-1/2	0956DP3CHR	0956003CHR	0956003PLB	1.0/6.3/0.7
3	0956DP4CHR	0956004CHR	0956004PLB	1.0/6.5/0.8
3-1/2	0956DP5CHR	—————	0956005PLB	1.1/-/0.8
4	0956DP6CHR	0956006CHR*	0956006PLB	1.2/4.7/1.0
5	0956DP7CHR	0956007CHR**	0956007PLB	1.4/1.2/1.1
6	0956DP8CHR	0956008CHR*	0956008PLB	1.7/5.8/1.3

*OEM Bulk Pkg. - 25 pcs. Screw Size #6.
** 5 Pcs.

SPARE PARTS ORDERING INFORMATION

Bronze Keepers (2 per card): 0959DP0PLB
Chrome Keepers (2 per card): 0959DP0CHR
Chrome Keepers OEM Bulk (100 pcs.): 0959000CHR



Fig. 1199



**Fig. 1261
Spare Keeper Only**

Fig. 1199 - Cabin Door Hook

CONSTRUCTION:

- Chrome Plated Zinc Alloy

ORDERING & TECH INFO

Length Hook Inches	Dealer Pkg. 20 Cards 1 Pc. per Card	OEM Bulk Pkg. 50 Pcs.	Screw Size	Ship Wt. Carton Lbs. DP/OEM Bulk
1-3/4	1199DP1CHR	1199001CHR	6	2.7/4.8
2-1/4	1199DP2CHR	1199002CHR	6	2.8/5.1
3	1199DP3CHR	1199003CHR	6	3.1/5.8
4	1199DP4CHR	1199004CHR	6	3.4/6.6

SPARE PARTS ORDERING INFORMATION

Keepers (2 per card): 1261DPOCHR

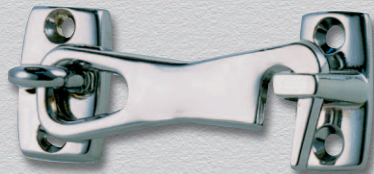

Fig. 1287



**Fig. 1261
Spare Keeper Only**

Fig. 1287 - Cabin Door Hook

CONSTRUCTION:

- Chrome Plated Zinc Alloy

ORDERING & TECH INFO

Length Hook Inches	Dealer Pkg. 20 Cards 1 Pc. per Card	OEM Bulk Pkg. 50 Pcs.	Screw Size	Ship Wt. Carton Lbs. DP/OEM Bulk
2	1287DP1CHR	1287001CHR	6	2.9/5.2
2-1/2	1287DP2CHR	1287002CHR	6	3.1/5.9
3	1287DP3CHR	1287003CHR	6	3.2/6.0

SPARE PARTS ORDERING INFORMATION

Keepers (2 per card): 1261DPOCHR

DOOR STOPS, HOLDER AND BUTTONS

Fig. 0574 - Door Stop and Holder

CONSTRUCTION:

- Chrome Plated Bronze
- Rubber Bumper

ORDERING & TECH INFO

Length Inches	O.D. Inches	Dealer Pkg. 5 Cards 1 Pc. per Card	OEM Bulk Pkg. 25 Pcs.	Stop Screw Size	Keeper Screw Size	Ship Wt. Carton Lbs. DP/OEM Bulk
2-3/8	1-3/4	0574DP1CHR	0574001CHR	8	6	1.4/5.2
3-1/4	1-3/4	0574DP2CHR	0574002CHR	8	6	1.7/6.3



Fig. 0574

Fig. 1177 - Door Stop

CONSTRUCTION:

- Chrome Plated Zinc Alloy
- Rubber Bumper

ORDERING & TECH INFO

Length Inches	O.D. Inches	Dealer Pkg. 5 Cards 1 Pc. per Card	OEM Bulk Pkg. 50 Pcs.	Screw Size	Ship Wt. Carton Lbs. DP/OEM Bulk
1	1-1/4	1177DP0CHR	1177000CHR	6	0.6/2.9



Fig. 1177

Fig. 1065 - Door Holder

CONSTRUCTION:

- Stainless Steel Clip
- Chrome Plated Zinc Alloy Arrow

ORDERING & TECH INFO

Dimensions Arrow Base Inches	Dimensions Clip Base Inches	Projection Inches	Dealer Pkg. 5 Cards 1 Pc. per Card	Screw Size	Ship Wt. Carton Lbs. Dealer Pkg.
1-5/8 x 3/4	1-3/8 x 7/16	1-3/4	1065DP0CHR	8	1.0

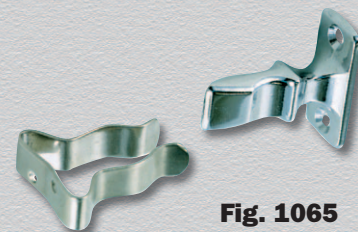

Fig. 1065

Figs. 1216 & 1217 - Door Buttons

CONSTRUCTION:

- Chrome Plated Zinc Alloy
- Black Polymer Button

Fig. 1216 - Supplied with Phosphor Bronze Tension Spring

Fig. 1217 - Supplied without Spring and Requires a No. 8 Oval-Head Pivot Screw

ORDERING & TECH INFO

Type	O.D. Overall Inches	Dealer Pkg. 10 Cards 1 Pc. per Card	OEM Bulk Pkg. 50 Pcs.	Screw Size	Ship Wt. Carton Lbs. DP/OEM Bulk
With Spring	1-3/4	1216DP0CHR	1216000CHR	6	1.3/4.2
w/o Spring	1-3/4	1217DP0CHR	1217000CHR	6	1.2/4.0

SPARE PARTS ORDERING INFORMATION

Button for Both: 121600099A.



Fig. 1216



Fig. 1217

DOOR CATCHES & SLAM CAM BAR



Fig. 0554

Fig. 0554 - Door Catch

CONSTRUCTION:

- White Polymer
- Stainless Steel Mounting & Keeper Screws

ORDERING & TECH INFO

Catch Screw Size Inches	Dimensions Catch Inches	Dealer Pkg. 25 Cards 2 Pcs. per Card	OEM Bulk Pkg. 100 Pcs.	Ship Wt. Carton Lbs. DP/OEM Bulk
3/4 x #8	1-1/4 x 5/8	0554DP	0554	2.1/2.7

9

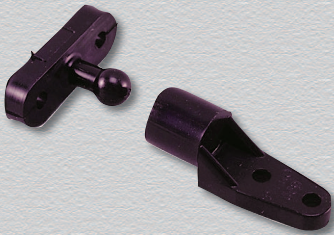

Fig. 0559

Fig. 0559 - Door Catch

CONSTRUCTION:

- Black Polymer

ORDERING & TECH INFO

Dimensions Stud Inches	Dimensions Catch Inches	Dealer Pkg. 25 Cards 2 Pcs. per Card	OEM Bulk Pkg. 100 Pcs.	Screw Size	Ship Wt. Carton Lbs. DP/OEM Bulk
1-1/8 x 3/8	1-3/8 x 7/8	0559DP	0559	4 R.H.	1.5/1.0

Fig. 1075 - Slam Cam Bar



Fig. 1075

NEW Item

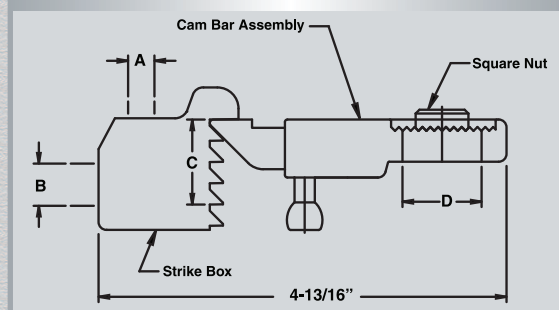

Fig. 1085 Lock shown with Slam Cam Bar Installed

CONSTRUCTION:

- Chrome Plated Bronze with Black Polymer Release Knob
- Black Polymer Strike

CAM BAR ADJUSTMENT DIAGRAM



ORDERING & TECH INFO

(A) Horizontal Strike Box Adjustment Inches	(B) Vertical Strike Box Adjustment Inches	(C) Vertical Cam Bar Adjustment Inches	(D) Lateral Cam Bar Adjustment Inches	Cam Bar Length Inches	Dealer Pkg 1 Pc.	OEM Bulk Pkg. 10 Pcs.	Ship Wt. Carton Lbs. DP/OEM Bulk
5/16	1/2	1	9/16	3-1/2	1075DP7CHR	1075007CHR	0.6/4.5

Screw Size #10-24

"T" - HANDLE SURFACE MOUNT LOCK

NEW Item

Fig. 1085 - Surface Mount Lock For Smooth and Carpeted Surfaces (Gasket Included for Smooth Surface Applications)

CONSTRUCTION:

- Black, White or Gray Polymer Body
- Chrome Plated Zinc Alloy "T" Handle
- Stainless Steel Stem
- Face Plate Diameter 3"

- No. 1 with Offset Cam Bar
- No. 3 with Straight Cam Bar
- No. 4 with Extra Long Offset Cam Bar
- No. 5 with Extra Long Straight Cam Bar
- No. 6 with Extra Long Offset Cam Bar
- No. 7 with Slam Cam Bar

Easily Installs in a 2-1/2 Inch Diameter Hole For Mounting Surfaces 1/8 to 3/4 of an Inch Thick

Fig. 1085 Lock shown with No. 1 Offset Cam Bar



9

ORDERING & TECH INFO

Body Color	Adjustment Cam Bar Inches	OEM Bulk Pkg. 25 Pcs.	Dealer Pkg.- 5 Cards 1 Pc. per Card	Ship Wt. Carton Lbs. OEM Bulk/DP
Black	3/4 to 2-3/8	1085001BLK	1085DP1BLK	14.8/3.8
Black	1-1/4 to 1-7/8	1085003BLK	1085DP3BLK	15.7/4.0
Black	1/2 to 3	1085004BLK	1085DP4BLK	17.0/4.2
Black	1-1/4 to 2	1085005BLK	1085DP5BLK	17.4/4.0
Black	1-1/8 to 2	1085006BLK	1085DP6BLK	17.4/4.1
Black	See Page 218	1085007BLK	1085DP7BLK	24.0/5.4
White	3/4 to 2-3/8	1085001WHT	1085DP1WHT	14.8/4.0
White	1-1/4 to 1-7/8	1085003WHT	1085DP3WHT	15.5/4.0
White	1/2 to 3	1085004WHT	1085DP4WHT	17.4/4.2
White	1-1/4 to 2	1085005WHT	1085DP5WHT	17.4/4.0
White	1-1/8 to 2	1085006WHT	1085DP6WHT	17.4/4.1
White	See Page 218	1085007WHT	1085DP7WHT	24.0/5.4
Gray	3/4 to 2-3/8	1085001GRY	_____	14.8/-
Gray	1-1/4 to 1-7/8	1085003GRY	_____	13.8/-
Gray	1/2 to 3	1085004GRY	_____	14.9/-
Gray	1-1/4 to 2	1085005GRY	_____	14.9/-
Gray	1-1/8 to 2	1085006GRY	_____	14.9/-
Gray	See Page 218	1085007GRY	_____	21.4/-

SPARE PARTS ORDERING INFORMATION

Threaded Shaft Cam Bars
 Offset: 109100188A
 Straight: 109100388A
 Extra Long Offset: 109100488A
 Extra Long Straight: 109100588A
 Extra Long Offset: 109100688A
 Slam Cam: 1075007CHR

Old Style Square Shaft Cam Bars
 Offset: 109100199A
 Straight: 109100399A
 Extra Long Offset: 109100499A
 Extra Long Straight: 109100599A

CAM BAR OPTIONS

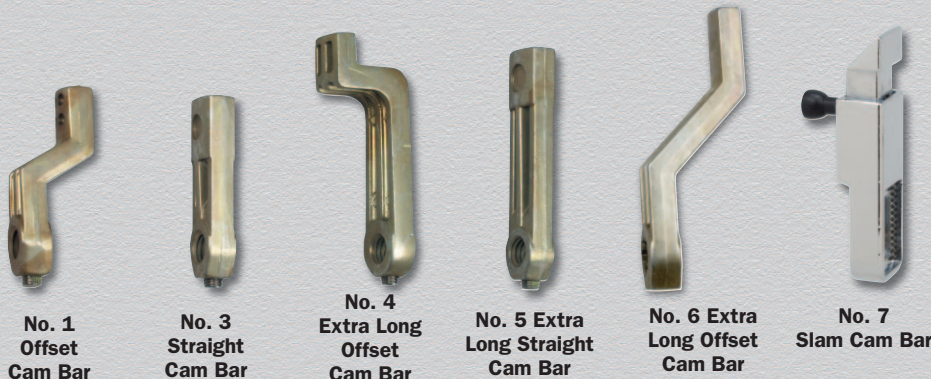

NEW Item

Fig. 1085 Lock shown with No. 7 Slam Cam Bar



"T" - HANDLE SURFACE MOUNT LOCK & LATCH



Figs. 1091 & 1092 - Surface Mount Lock & Latch For Smooth and Carpeted Surfaces (Gasket Included for Smooth Surface Applications)

CONSTRUCTION:

- Black, White or Gray Polymer Body
- Chrome Plated Zinc Alloy, Black or White Polymer "T" Handle
 - Stainless Steel Stem

Fig. 1091 - Lock with 2 Keys Fig. 1092 - Latch (Non-Locking)

- No. 1 with Offset Cam Bar
- No. 3 with Straight Cam Bar
- No. 4 with Extra Long Offset Cam Bar
- No. 5 with Extra Long Straight Cam Bar
- No. 6 with Extra Long Offset Cam Bar
- No. 7 with Slam Cam Bar

Easily Installs in a 2-1/2 Inch Diameter Hole
For Mounting Surfaces 1/8 to 3/4 Inch Thick
Face Plate Diameter 3"

Fig. 1091 #1
Black/Chrome

Fig. 1092 #1
White/Chrome

Fig. 1091 #1
Black/Black



Mounting Options:



Surface Mount



Upholstery Mount



Carpet Mount

Fig. 1092 #1
Gray/Chrome



Latch Version

Rubber Seal



Lock Version



The Rubber Seal & Boot Under the T-Handle Seals the Lock Cylinder Preventing Water Intrusion

The T-Handle Drops Down Flush in Either the Open or Closed (180° Rotation) Position (Except with the Offset Cam Bar Positioned Upward)

CAM BAR OPTIONS



See Page 238
for Matching Pull



No. 1
Offset
Cam Bar



No. 3
Straight
Cam Bar



No. 4
Extra Long
Offset Cam Bar



No. 5 Extra
Long Straight
Cam Bar



No. 6 Extra
Long Offset
Cam Bar



No. 7
Slam
Cam Bar

"T" - HANDLE SURFACE MOUNT LOCK & LATCH

ORDERING & TECH INFO

Type	Body Color	Handle Color	Adjustment Cam Bar Inches	OEM Bulk Pkg. 25 Pcs.	Dealer Pkg. 5 Cds 1 Pc. per Card	Ship Wt. Carton Lbs. OEM Bulk/DP
Lock	Black	Chrome	No Cam Bar	—	1091DP0BLK*	-/3.5
Lock	Black	Chrome	3/4 to 2-3/8	1091001BLK	1091DP1BLK	15.7/3.9
Lock	Black	Chrome	1-1/4 to 1-7/8	1091003BLK	1091DP3BLK	15.7/4.0
Lock	Black	Chrome	1/2 to 3	1091004BLK	1091DP4BLK	17.2/4.2
Lock	Black	Chrome	1-1/4 to 2	1091005BLK	1091DP5BLK	17.4/4.0
Lock	Black	Chrome	1-1/8 to 2	1091006BLK	1091DP6BLK	17.4/4.1
Lock	Black	Chrome	See Page 218	1091007BLK**	1091DP7BLK**	24.0/5.4
Lock	Black	Black	3/4 to 2-3/8	1091B01BLK	—	13.1/-
Lock	Black	Black	1-1/4 to 1-7/8	1091B03BLK	—	13.3/-
Lock	Black	Black	1/2 to 3	1091B04BLK	—	14.9/-
Lock	Black	Black	1-1/4 to 2	1091B05BLK	—	14.9/-
Lock	Black	Black	1-1/8 to 2	1091B06BLK	—	14.9/-
Lock	Black	Black	See Page 218	1091B07BLK**	—	21.4/-
Lock	White	Chrome	No Cam Bar	—	1091DP0WHT*	-/3.5
Lock	White	Chrome	3/4 to 2-3/8	1091001WHT	1091DP1WHT	15.7/3.9
Lock	White	Chrome	1-1/4 to 1-7/8	1091003WHT	1091DP3WHT	15.7/4.0
Lock	White	Chrome	1/2 to 3	1091004WHT	1091DP4WHT	17.2/4.2
Lock	White	Chrome	1-1/4 to 2	1091005WHT	1091DP5WHT	17.4/4.0
Lock	White	Chrome	1-1/8 to 2	1091006WHT	1091DP6WHT	17.4/4.1
Lock	White	Chrome	See Page 218	1091007WHT**	1091DP7WHT**	24.0/5.4
Lock	White	White	3/4 to 2-3/8	1091W01WHT	—	13.8/-
Lock	White	White	1-1/4 to 1-7/8	1091W03WHT	—	13.3/-
Lock	White	White	1/2 to 3	1091W04WHT	—	14.9/-
Lock	White	White	1-1/4 to 2	1091W05WHT	—	14.9/-
Lock	White	White	1-1/8 to 2	1091W06WHT	—	14.9/-
Lock	White	White	See Page 218	1091W07WHT**	—	21.4/-
Lock	Gray	Chrome	3/4 to 2-3/8	1091001GRY	—	15.7/-
Lock	Gray	Chrome	1-1/4 to 1-7/8	1091003GRY	—	15.7/-
Lock	Gray	Chrome	1/2 to 3	1091004GRY	—	17.2/-
Lock	Gray	Chrome	1-1/4 to 2	1091005GRY	—	17.4/-
Lock	Gray	Chrome	1-1/8 to 2	1091006GRY	—	17.4/-
Lock	Gray	Chrome	See Page 218	—	—	—
Latch	Black	Chrome	No Cam Bar	—	1092DP0BLK*	-/3.5
Latch	Black	Chrome	3/4 to 2-3/8	1092001BLK	1092DP1BLK	12.8/3.5
Latch	Black	Chrome	1-1/4 to 1-7/8	1092003BLK	1092DP3BLK	14.0/3.7
Latch	Black	Chrome	1/2 to 3	1092004BLK	1092DP4BLK	15.5/4.0
Latch	Black	Chrome	1-1/4 to 2	1092005BLK	1092DP5BLK	14.6/3.8
Latch	Black	Chrome	1-1/8 to 2	1092006BLK	1092DP6BLK	14.6/3.9
Latch	Black	Chrome	See Page 218	1092007BLK**	1092DP7BLK**	21.1/5.2
Latch	Black	Black	3/4 to 2-3/8	1092B01BLK	—	11.4/-
Latch	Black	Black	1-1/4 to 1-7/8	1092B03BLK	—	11.5/-
Latch	Black	Black	1/2 to 3	1092B04BLK	—	13.2/-
Latch	Black	Black	1-1/4 to 2	1092B05BLK	—	12.0/-
Latch	Black	Black	1-1/8 to 2	1092B06BLK	—	12.0/-
Latch	Black	Black	See Page 218	1092B07BLK**	—	18.5/-
Latch	White	Chrome	No Cam Bar	—	1092DP0WHT*	-/3.5
Latch	White	Chrome	3/4 to 2-3/8	1092001WHT	1092DP1WHT	13.8/3.5
Latch	White	Chrome	1-1/4 to 1-7/8	1092003WHT	1092DP3WHT	14.0/3.7
Latch	White	Chrome	1/2 to 3	1092004WHT	1092DP4WHT	15.5/4.0
Latch	White	Chrome	1-1/4 to 2	1092005WHT	1092DP5WHT	14.6/3.8
Latch	White	Chrome	1-1/8 to 2	1092006WHT	1092DP6WHT	14.6/3.9
Latch	White	Chrome	See Page 218	1092007WHT**	1092DP7WHT**	21.1/5.2
Latch	White	White	3/4 to 2-3/8	1092W01WHT	—	11.4/-
Latch	White	White	1-1/4 to 1-7/8	1092W03WHT	—	11.5/-
Latch	White	White	1/2 to 3	1092W04WHT	—	13.2/-
Latch	White	White	1-1/4 to 2	1092W05WHT	—	12.0/-
Latch	White	White	1-1/8 to 2	1092W06WHT	—	12.0/-
Latch	White	White	See Page 218	1092W07WHT**	—	18.5/-
Latch	Gray	Chrome	3/4 to 2-3/8	1092001GRY	—	13.8/-
Latch	Gray	Chrome	1-1/4 to 1-7/8	1092003GRY	—	14.0/-
Latch	Gray	Chrome	1/2 to 3	1092004GRY	—	15.5/-
Latch	Gray	Chrome	1-1/4 to 2	1092005GRY	—	14.6/-
Latch	Gray	Chrome	1-1/8 to 2	1092006GRY	—	14.6/-
Latch	Gray	Chrome	See Page 218	1092007GRY**	—	21.1/-

* New Item: Dealers Order with Cam Bar Assortment: 1091DP099A

** New Fig. 1075 Slam Cam Version

SPARE PARTS ORDERING INFORMATION

Old Style Square Shaft Cam Bars
 Offset Cam Bar: 109100199A
 Straight Cam Bar: 109100399A
 Extra Long Offset Cam Bar: 109100499A
 Extra Long Straight Cam Bar: 109100599A

Threaded Shaft Cam Bars
 Offset Cam Bar: 109100188A
 Straight Cam Bar: 109100388A
 Extra Long Offset Cam Bar: 109100488A
 Extra Long Straight Cam Bar: 109100588A
 Extra Long Offset Cam Bar: 109100688A
 Slam Cam Bar: 1075007CHR or 1075DP7CHR



FLUSH LOCKS & LATCHES



Figs. 0931 & 1031 - Flush Locks with 2 Keys
Figs. 0932 & 1032 - Flush Latches (Non-Locking)



CONSTRUCTION:

- Black or White Polymer
- Chrome Plated Zinc Alloy
- Stainless Steel Stem and Lock Nut

Figs. 0931/0932

- No. 1 with Offset Cam Bar and Flexible Polymer Strike
- No. 2 with Offset Adjustable Cam Bar
- No. 3 with Straight Cam Bar and Flexible Polymer Strike

Detents Indicate Open or Closed Position.
 Easily Installs in a 2 Inch Diameter Hole.
 For Door Thickness 1/4 to 1-1/8 Inches
 Dimensions Face Plate 2-1/2" x 2-1/2"

Figs. 1031/1032

- Large Handle Allows Two Finger Grip
- Flush Mounts in a 2-3/8 x 2-3/8 Inch Hole
- Surface Mounts in a 1-5/8 Inch Diameter Hole
- With Polymer Spacer Included
- For Door Thickness 1/8 to 3/4 Inch
- Dimensions Face Plate 3-1/8" x 3-1/8"

9

ORDERING & TECH INFO

Type	Adjustment Cam Bar Inches	Black Dealer Pkg. 5 Cds 1 Pc. per Card	White Dealer Pkg. 5 Cds 1 Pc. per Card	Black OEM Bulk Pkg. 25 Pcs.	White OEM Bulk Pkg. 25 Pcs.	Ship Wt. Carton Lbs. DP/OEM Bulk
Lock	3/8 to 3	0931DP1BLK	0931DP1WHT	0931001BLK	0931001WHT	3.2/12.5
Lock	3/8 to 3	0931DP2BLK	0931DP2WHT	0931002BLK	0931002WHT	3.1/12.1
Lock	1-1/16 to 2-9/16	0931DP3BLK	0931DP3WHT	0931003BLK	0931003WHT	3.4/13.2
Latch	3/8 to 3	0932DP1BLK	0932DP1WHT	0932001BLK	0932001WHT	3.0/11.0
Latch	3/8 to 3	0932DP2BLK	0932DP2WHT	0932002BLK	0932002WHT	2.9/10.8
Latch	1-1/16 to 2-9/16	0932DP3BLK	0932DP3WHT	0932003BLK	0932003WHT	3.1/11.8
Lock	1/2 to 3	1031DP1BLK	1031DP1WHT	1031001BLK	1031001WHT	4.1/16.8
Latch	1/2 to 3	1032DP1BLK	1032DP1WHT	1032001BLK	1032001WHT	4.0/15.1

SPARE PARTS ORDERING INFORMATION

Offset Cam Bar: 093100199A Offset Adjustable Cam Bar: 093100299A
 Straight Cam Bar: 093100399A Flexible Polymer Strike: 093100099B
 Offset Cam Bar For 1031/1032: 103100499A

Fig. 1089 - Lock & Latch Cover
CONSTRUCTION:

- Black or White Fiber Reinforced Polymer
- Hinged, Water Resistant



Fig. 1089

ORDERING & TECH INFO

Color	Fits Fig. No.	Overall Dimensions	Dealer Pkg. - 5 Cards 1 Pc. per Card	OEM Bulk Pkg. 25 Pcs.	Ship Wt. Carton Lbs. DP/OEM Bulk
Black	0931/0932	2-3/4 x 3-1/4	1089DP1BLK	1089001BLK	0.7/2.0
White	0931/0932	2-3/4 x 3-1/4	1089DP1WHT	1089001WHT	0.7/2.0
Black	1031/1032	3-1/4 x 3-3/4	1089DP3BLK	1089003BLK	1.0/3.4
White	1031/1032	3-1/4 x 3-3/4	1089DP3WHT	1089003WHT	1.0/3.4



Figs. 1071 & 1072 - Flush Lock & Latch For Carpeted Surfaces

Figs. 1081 & 1082 - Flush Lock & Latch For Smooth or Carpeted Surfaces (Includes Gasket for Smooth Surface Applications)

Construction:

- Black or White Polymer
- Stainless Steel “D” Ring Handle
- Stem and Lock Nut
- Two O-Rings for Increased Water Resistance
- Position Indicator Shows Open or Closed Position
- Face Plate Dimensions: 2-7/8” x 2-7/8”

Fig. 1071 - Lock with 2 Keys

Fig. 1072 - Latch (Non-Locking)

Fig. 1081 - Lock with 2 Keys and Gasket

Fig. 1082 - Latch (Non-Locking) and Gasket

No. 1 with Offset Cam Bar and Flexible Polymer Strike

No. 2 with Offset Adjustable Cam Bar

No. 3 with Straight Cam Bar and Flexible Polymer Strike

Easily Installs in a 2-3/8 Inch Diameter Hole
For Mounting Surfaces 3/8 to 7/8 Inch Thick

Fig. 1071 #1

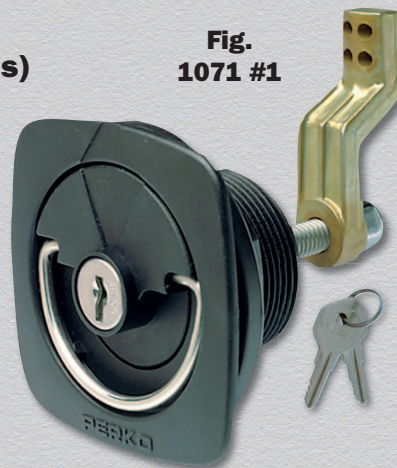

Fig. 1072 #2

Flexible Polymer Strike

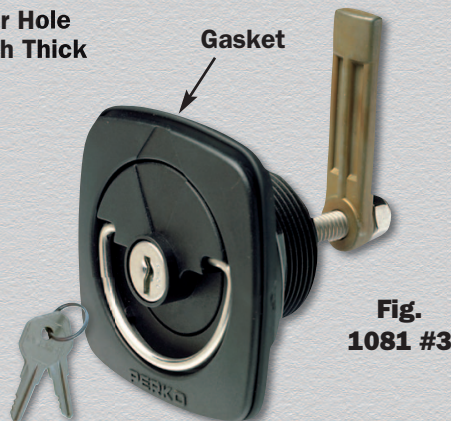

Fig. 1081 #3

ORDERING & TECH INFO

Color	Type	Adjustment Cam Bar Inches	Figs. 1071/1072 OEM Bulk Pkg. 25 Pcs.	Figs. 1081/1082 Dealer Pkg. - 5 Cards 1 Pc. per Card	Figs. 1081/1082 OEM Bulk Pkg. 25 Pcs.	Ship Wt. Carton Lbs. DP/OEM Bulk
Black	Lock	3/8 to 3	1071001BLK	1081DP1BLK	1081001BLK	3.4/12.7
Black	Lock	3/8 to 3	1071002BLK	1081DP2BLK	1081002BLK	3.3/12.7
Black	Lock	1-1/16 to 2-9/16	1071003BLK	1081DP3BLK	1081003BLK	3.5/13.6
Black	Latch	3/8 to 3	1072001BLK	1082DP1BLK	1082001BLK	3.1/11.4
Black	Latch	3/8 to 3	1072002BLK	1082DP2BLK	1082002BLK	3.0/11.1
Black	Latch	1-1/16 to 2-9/16	1072003BLK	1082DP3BLK	1082003BLK	3.2/12.2
White	Lock	3/8 to 3	1071001WHT	1081DP1WHT	1081001WHT	3.4/12.7
White	Lock	3/8 to 3	1071002WHT	1081DP2WHT	1081002WHT	3.3/12.7
White	Lock	1-1/16 to 2-9/16	1071003WHT	1081DP3WHT	1081003WHT	3.5/13.6
White	Latch	3/8 to 3	1072001WHT	1082DP1WHT	1082001WHT	3.1/11.4
White	Latch	3/8 to 3	1072002WHT	1082DP2WHT	1082002WHT	3.0/11.1
White	Latch	1-1/16 to 2-9/16	1072003WHT	1082DP3WHT	1082003WHT	3.2/12.2

SPARE PARTS ORDERING INFORMATION

Offset Cam Bar: 093100199A Offset Adjustable Cam Bar: 093100299A
Straight Cam Bar: 093100399A Flexible Polymer Strike: 093100099B

SELF ADJUSTING SLAM LATCH CAM BAR SELECTION GUIDE



Fig. 0675

Self-Adjusting, Ratcheting Slide Action Design

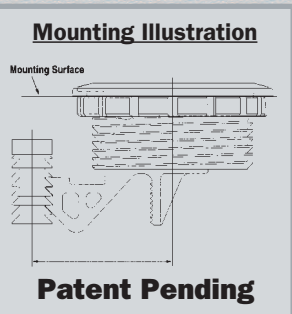

Fig. 0675 - Self Adjusting Slam Latch
Patent No. 7,066,504

CONSTRUCTION:

- Black or White Polymer

Key Features

“Unique to PERKO”

- 1) “PERKO Leak Proof” Slide Action Design Keeps Inside of Hatches Dry
- 2) Self-Adjusting, Ratcheting Cam Bar/Strike Permits Installations with Slight Misalignment of Components

Additional Features

- Similar in look to Popular PERKO Fig. 1091 Series
- For Mounting Surfaces 1/8” to 3/4” Thick
 - Installs in a 2” Diameter Hole
 - Simple One Nut Installation
- Dealer Package includes 2 strikes to accommodate a variety of mounting configurations

ORDERING & TECH INFO

Adjustment Cam Bar Inches	O.D. Face Plate Inches	Dealer Pkg. 5 Cards 1 Pc. per Card	OEM Bulk Pkg. 25 Pcs.	Ship Wt. Carton Lbs. DP/OEM Bulk
1/8 to 3/4	2-3/8	0675DPBBLK	0675B00BLK	1.2/5.4
1/8 to 3/4	2-3/8	0675DPWWHT	0675W00WHT	1.2/5.4

CAM BAR SELECTION GUIDE

Cam Bars for 0931/0932, 1071/1072 and 1081/1082 Series Lock & Latch Sets with 5/16” Shafts

#1 Style Cam Bar

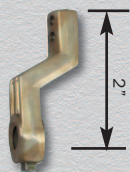

Offset Cam Bar

#2 Style Cam Bar



Offset Adjustable Cam Bar

#3 Style Cam Bar



Straight Cam Bar

Cam Bars for 1085, 1091/92, 1094/95 and 1031/1032 Series Lock & Latch Sets with 3/8” Shafts

#1 Style *

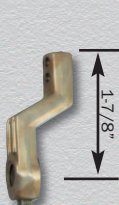

Offset Cam Bar For 1085, 1091/1092 & 1094/1095 Series

#3 Style *



Straight Cam Bar For 1085, 1091/1092 & 1094/1095 Series

#4 Style *



Extra Long Offset Cam Bar as used on 1085, 1091/1092, 1094/1095 & 1031/1032 Series

#5 Style *

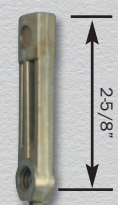

Extra Long Straight Cam Bar as used on 1085, 1091/1092 & 1094/1095 Series

#6 Style *

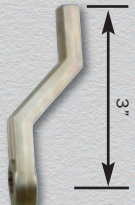

Extra Long Offset Cam Bar as used on 1085, 1091/1092 Series

#7 Style *

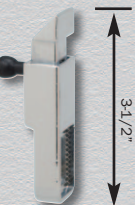

Slam Cam Bar as used on 1085, 1091 & 1092 Series

Measurements are from the center of the lock set to the top of the cam bar shaft end.
*Note: 1091/1092 series have offset center shafts, add 5/8” for Dimension from center.

ADDITIONAL LOCK & LATCH MOUNTING OPTIONS

Fig. 1097



Detail Showing Available Upholstery Mounting Ring
Contact Factory for details



Figs. 1094 & 1095

Flush Mounting versions available. Includes special nut for mounting to underneath of the deck or a hatch. Contact Factory for details.

DETERMINING THE HAND OF A LOCK OR LATCH SET

DETERMINING THE HAND OF THE LATCH SET.

When Standing Outside: If the Door Opens Away From You, Then You Need a Lock or Latch with a Regular Bevel.

If the Door Opens Toward You, Then You Need a Lock or Latch with a Reverse Bevel.

Refer to the illustrations below when selecting the proper hand configuration of the lock and latch sets on the following pages.

When Standing Outside



A

Lock/Latch Type:
LEFT INWARD
Regular Bevel



B

Lock/Latch Type:
LEFT OUTWARD
Reverse Bevel



C

Lock/Latch Type:
RIGHT INWARD
Regular Bevel



D

Lock/Latch Type:
RIGHT OUTWARD
Reverse Bevel

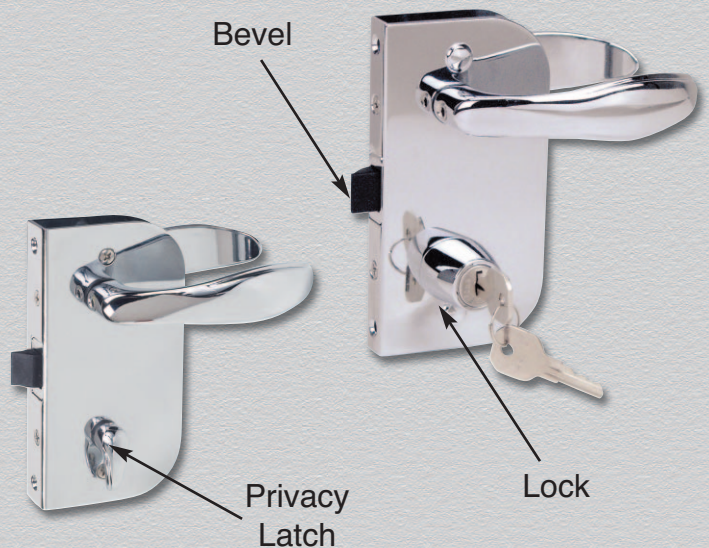

NOTE: The privacy latch handle should always be mounted on the door's interior side

MORTISE LATCH AND LOCK SETS

Fig. 0710 - Full Size Mortise Latch Set Fig. 0730 - Full Size Mortise Lock Set

With Privacy Lock for Interior Cabins and Head Enclosures

CONSTRUCTION:

- Chrome Plated Brass and Zinc Alloy
 - Two Escutcheon Plates
 - Overall Height: 5-1/4 Inches

Fig. 0710 - Safety Unlock from Outside

Fig. 0730 - Keyed Lock from Outside

- Interior Turn Button Lock Mechanism from Inside

For Door Thickness 3/4 to 1-1/2 Inches

Bevels are Interchangeable



**Fig. 0730
Mortise Lock**



**Fig. 0710
Mortise Latch**

ORDERING & TECH INFO

Type	Hand Of Lock/Latch*	For Door Thickness Inches	Std Pkg. 1 Set	Ship Wt. Ctn. Lbs. Standard Pkg.
Latch	A or D	3/4 to 1	0710001LIC	1.5
Latch	A or D	1 to 1-1/4	0710002LIC	1.5
Latch	A or D	1-1/4 to 1-1/2	0710003LIC	1.5
Latch	B or C	3/4 to 1	0710001RIC	1.5
Latch	B or C	1 to 1-1/4	0710002RIC	1.5
Latch	B or C	1-1/4 to 1-1/2	0710003RIC	1.5
Lock	A or D	3/4	0730001LIC	1.7
Lock	A or D	7/8	0730002LIC	1.7
Lock	A or D	1	0730003LIC	1.7
Lock	A or D	1-1/8	0730004LIC	1.7
Lock	A or D	1-1/4	0730005LIC	1.7
Lock	A or D	1-3/8	0730006LIC	1.7
Lock	A or D	1-1/2	0730007LIC	1.7
Lock	B or C	3/4	0730001RIC	1.7
Lock	B or C	7/8	0730002RIC	1.7
Lock	B or C	1	0730003RIC	1.7
Lock	B or C	1-1/8	0730004RIC	1.7
Lock	B or C	1-1/4	0730005RIC	1.7
Lock	B or C	1-3/8	0730006RIC	1.7
Lock	B or C	1-1/2	0730007RIC	1.7

Fig. 0706 - Full Size Mortise Latch Set without Privacy Lock

CONSTRUCTION:

- Chrome Plated Brass and Zinc Alloy
 - Two Escutcheon Plates
 - Overall Height: 5-1/4 Inches
 - Safety Unlock from Outside

For Door Thickness 3/4 to 1-1/2 Inches

Bevels are Interchangeable



**Fig. 0706
Mortise Latch
w/o Privacy
Latch**

ORDERING & TECH INFO

Type	Hand Of Lock/Latch*	For Door Thickness Inches	Std Pkg. 1 Set	Ship Wt. Ctn. Lbs. Standard Pkg.
Latch	A or D	3/4 to 1	0706001LIC	1.5
Latch	A or D	1 to 1-1/4	0706002LIC	1.5
Latch	A or D	1-1/4 to 1-1/2	0706003LIC	1.5
Latch	B or C	3/4 to 1	0706001RIC	1.5
Latch	B or C	1 to 1-1/4	0706002RIC	1.5
Latch	B or C	1-1/4 to 1-1/2	0706003RIC	1.5

* Note: Refer to Page 225 to determine the proper hand of a lock or latch set.

PERKO® FLUSH MOUNT LATCH AND LOCK SETS

Fig. 0711 - Full Size Flush Latch Set
Fig. 0731 - Full Size Flush Lock Set
With Privacy Latches for Interior Cabins and Head Enclosures

CONSTRUCTION:

- Chrome Plated Brass and Zinc Alloy
- Overall Height: 5-1/4 Inches
- Fig. 0711 - Safety Unlock from Outside
- Fig. 0731 - Keyed Lock from Outside
- Interior Turn Button Lock Mechanism from Inside

For Door Thickness 1/2 to 3/4 Inch

ORDERING & TECH INFO

Type	Hand Of Lock/Latch*	For Door Thickness		Ship Wt. Ctn. Lbs.	
		Inches	Std Pkg. 1 Set	Standard Pkg.	
Latch	A	1/2	0711001LIC		1.5
Latch	A	5/8	0711002LIC		1.5
Latch	A	3/4	0711003LIC		1.5
Latch	B	1/2	0711001LOC		1.5
Latch	B	5/8	0711002LOC		1.5
Latch	B	3/4	0711003LOC		1.5
Latch	C	1/2	0711001RIC		1.5
Latch	C	5/8	0711002RIC		1.5
Latch	C	3/4	0711003RIC		1.5
Latch	D	1/2	0711001ROC		1.5
Latch	D	5/8	0711002ROC		1.5
Latch	D	3/4	0711003ROC		1.5
Lock	A	1/2	0731001LIC		1.6
Lock	A	5/8	0731002LIC		1.6
Lock	A	3/4	0731003LIC		1.6
Lock	B	5/8	0731002LOC		1.6
Lock	B	3/4	0731003LOC		1.6
Lock	B	1/2	0731001LOC		1.6
Lock	C	5/8	0731002RIC		1.6
Lock	C	1/2	0731001RIC		1.6
Lock	C	3/4	0731003RIC		1.6
Lock	D	1/2	0731001ROC		1.6
Lock	D	5/8	0731002ROC		1.6
Lock	D	3/4	0731003ROC		1.6



**Fig. 0711
Flush Latch
Shown**



**Fig. 0731
Flush Lock**

9

Fig. 0715 Flush Latch Set
Without Privacy Latch for Interior Cabins and Head Enclosures

CONSTRUCTION:

- Chrome Plated Brass and Zinc Alloy
- Overall Height: 5-1/4 Inches
- Safety Unlock from Outside

For Door Thickness 1/2 to 3/4 Inch

ORDERING & TECH INFO

Type	Type Of Lock/Latch*	For Door Thickness		Ship Wt. Ctn. Lbs.	
		Inches	Std Pkg. 1 Set	Standard Pkg.	
Latch	A	1/2	0715001LIC		1.5
Latch	A	5/8	0715002LIC		1.5
Latch	A	3/4	0715003LIC		1.5
Latch	B	1/2	0715001LOC		1.5
Latch	B	5/8	0715002LOC		1.5
Latch	B	3/4	0715003LOC		1.5
Latch	C	1/2	0715001RIC		1.5
Latch	C	5/8	0715002RIC		1.5
Latch	C	3/4	0715003RIC		1.5
Latch	D	1/2	0715001ROC		1.5
Latch	D	5/8	0715002ROC		1.5
Latch	D	3/4	0715003ROC		1.5



**Fig. 0715
Flush Latch
w/o Privacy
Latch**

* Note: Refer to Page 225 to determine the proper hand of a lock or latch set.

PERKO® MORTISE LATCH AND LOCK SETS

Fig. 0712 Compact Mortise Latch Set with Privacy Lock for Interior Cabins and Head Enclosures

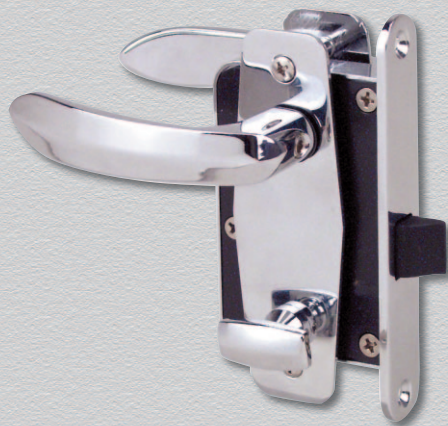

Fig. 0712 Compact Mortise Latch

CONSTRUCTION:

- Chrome Plated Brass and Zinc Alloy
 - Two Escutcheon Plates
 - Overall Height: 5-1/4 Inches
 - Safety Unlock from Outside
- Interior Turn Button Lock Mechanism from Inside

For Door Thickness 3/4 to 1-1/2 Inches

Bevels are Interchangeable

ORDERING & TECH INFO

Type	Hand Of Lock/Latch*	For Door Thickness Inches	Ship Wt. Ctn. Lbs.	
			Std Pkg. 1 Set	Standard Pkg.
Latch	A or D	3/4 to 1	0712001LIC	1.1
Latch	A or D	1 to 1-1/4	0712002LIC	1.5
Latch	A or D	1-1/4 to 1-1/2	0712003LIC	1.5
Latch	B or C	3/4 to 1	0712001RIC	1.1
Latch	B or C	1 to 1-1/4	0712002RIC	1.5
Latch	B or C	1-1/4 to 1-1/2	0712003RIC	1.5

NEW Item

Fig. 0716 - Full Size Surface Mount Lock Set



Fig. 0716 Surface Mount Lock

CONSTRUCTION:

- Chrome Plated Brass and Zinc Alloy
 - Overall Height: 5-1/4 Inches
 - Keyed Lock from Outside
- Interior Turn Button Lock Mechanism from Inside

For Door Thickness 1-1/16 to 1-3/8 Inches
For any other door thickness or other "hands", consult factory for availability

ORDERING & TECH INFO

Type	Hand Of Lock/Latch*	For Door Thickness Inches	Ship Wt. Ctn. Lbs.	
			Std Pkg. 1 Set	Standard Pkg.
Lock	D	1-1/16	0716001ROC	1.5
Lock	D	1-1/8	0716002ROC	1.5
Lock	D	1-3/8	0716003ROC	1.5

* Note: Refer to Page 225 to determine the proper hand of a lock or latch set.

Figs. 0991 & 0992 - Flush Latch Sets

CONSTRUCTION:

- Chrome Plated Zinc Alloy
- Sliding Lock Button

For Door Thickness 1/2 or 3/4 Inch

Fig. 0991 - Regular Bevel with Flush Strike

Fig. 0992 - Reverse Bevel with Flush Strike



**Fig. 0992 #1
with Lever Handle
Shown Assembled**

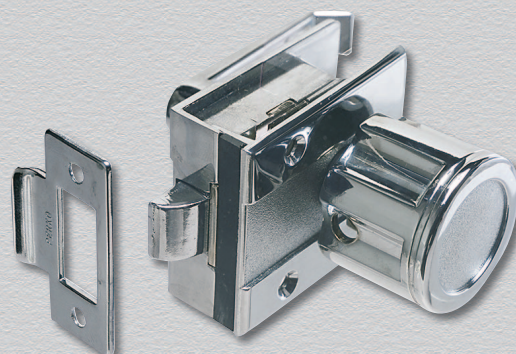

**Fig. 0991 #0
with Knob Handle
Shown Assembled**



**Figs. 0991 & 0992
Version #1**



**Figs. 0991 & 0992
Version #0**

ORDERING & TECH INFO

Handle Type	Bevel Type*	Dimensions Case Inches	Dimensions Escutcheon Inches	Dealer Pkg. 5 Sets 1 Set per Pkg.	OEM Bulk Pkg. 10 Sets	Ship Wt. Carton Lbs. DP/OEM Bulk
Knob	Regular	1-5/8 x 1-5/8	2 x 2-1/4	0991DPOCHR	0991000CHR	5.0/9.5
Knob	Reverse	1-5/8 x 1-5/8	2 x 2-1/4	0992DPOCHR	0992000CHR	5.0/9.5
Lever	Regular	1-5/8 x 1-5/8	2 x 2-1/4	0991DP1CHR	0991001CHR	4.6/8.9
Lever	Reverse	1-5/8 x 1-5/8	2 x 2-1/4	0992DP1CHR	0992001CHR	4.6/8.9

Screw Size #6

SPARE PARTS ORDERING INFORMATION

- Flush Strike: 0912DPOCHR.
- Regular Bevel with Cam: 0984000CHR
- Reverse Bevel with Cam: 0920DPOCHR
- Knob and Handle for Version #0: 0995000CHR
- Handle Set for Version #1: 0995001CHR

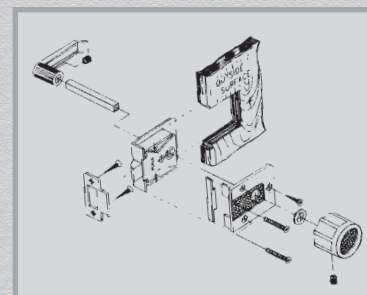

**Exploded
View Shows
Fig. 0992**

* Note: Refer to Page 225 to determine the proper hand of a lock or latch set.

LOCK & LATCH SETS

**Fig. 0928
Shown
Assembled**



Figs. 0928 & 1028

Figs. 0928 & 1028 - Rim Latch Sets

CONSTRUCTION:

- Chrome Plated Zinc Alloy
- Sliding Lock Button

For Door Thickness 5/8 to 1-3/8 Inches

Fig. 0928 - Regular Bevel with Box Strike
Fig. 1028 - Reverse Bevel with Box Strike

ORDERING INFO

Bevel Type*	Dealer Pkg. 5 Sets 1 Set per Card	OEM Bulk Pkg. 10 Sets	Ship Wt. Carton Lbs. DP/OEM Bulk
Regular	0928DP0CHR	0928000CHR	4.4/8.0
Reverse	1028DP0CHR	1028000CHR	4.4/8.0

TECH INFO

Dimensions Case:
2-1/8" x 1-3/4"
Dimensions Escutcheon:
4-3/8" x 1-1/4"
Screw Size: #6

SPARE PARTS ORDERING INFORMATION

Box Strike: 0976000CHR
Regular Bevel with Cam: 0984000CHR
Knob and Handle Assembly: 0962000CHR
Reverse Bevel with Cam: 0920DP0CHR

9

**Fig. 0930
Shown
Assembled**

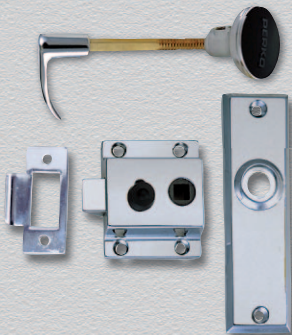

Figs. 0930 & 1030

Figs. 0930 & 1030 - Rim Latch Sets

CONSTRUCTION:

- Chrome Plated Zinc Alloy
- Sliding Lock Button

For Door Thickness 5/8 to 1-3/8 Inches

Fig. 0930 - Reverse Bevel with Flush Strike
Fig. 1030 - Regular Bevel with Flush Strike

ORDERING INFO

Bevel Type*	Dealer Pkg. 5 Sets 1 Set per Card	OEM Bulk Pkg. 10 Sets	Ship Wt. Carton Lbs. DP/OEM Bulk
Reverse	0930DP0CHR	0930000CHR	4.3/7.9
Regular	1030DP0CHR	1030000CHR	4.3/7.9

TECH INFO

Dimensions Case:
2-1/8" x 1-3/4" Dimen-
sions Escutcheon:
4-3/8" x 1-1/4"
Screw Size: #6

SPARE PARTS ORDERING INFORMATION

Flush Strike: 0912DP0CHR
Regular Bevel with Cam: 0984000CHR
Knob and Handle Assembly: 0962000CHR
Reverse Bevel with Cam: 0920DP0CHR

* Note: Refer to Page 225 to determine the proper hand of a lock or latch set.

Figs. 1239 & 1240 - Flush Cup Rim Latch Sets

CONSTRUCTION:

- Chrome Plated Zinc Alloy
- Sliding Lock Button

Supplied with Black Polymer Spacer For Surface Mounting
For Door Thickness 5/8 to 1 Inch

Fig. 1239 - Regular Bevel with Box Strike

Fig. 1240 - Reverse Bevel with Flush Strike



Figs. 1239 & 1240

ORDERING INFO			
Bevel Type*	Dealer Pkg. 5 Sets 1 Set per Pkg.	OEM Bulk Pkg. 10 Sets	Ship Wt. Carton Lbs. DP/OEM Bulk
Regular	1239DPOCHR	1239000CHR	4.4/8.3
Reverse	1240DPOCHR	1240000CHR	4.4/8.3

TECH INFO

Dimensions Case:
2" x 2-1/4"
O.D. Cup: 2-1/4"
Screw Size: #8



**Fig. 1239
Shown
Assembled**

SPARE PARTS ORDERING INFORMATION

Regular Bevel w/Cam: 0984000CHR Box Strike: 0977000CHR
Reverse Bevel w/Cam: 0920DPOCHR Flush Strike: 0912DPOCHR

Figs. 0929 & 1029 - Rim Latch Sets

Figs. 0968 & 1068 - Rim Latch Sets

CONSTRUCTION:

- Chrome Plated Zinc Alloy
- Sliding Lock Button

For Door Thickness 1/2 to 1 Inch

Fig. 0929 - Regular Bevel with Box Strike

Fig. 1029 - Reverse Bevel with Box Strike

Fig. 0968 - Regular Bevel with Flush Strike

Fig. 1068 - Reverse Bevel with Flush Strike



**Fig. 0929
Shown
Assembled**



**Figs. 0968 Figs. 0929
& 1068 & 1029**

ORDERING INFO				
Strike Type	Bevel Type*	Dealer Pkg. 5 Sets 1 Set per Card	OEM Bulk Pkg. 10 Sets	Ship Wt. Carton Lbs. DP/OEM Bulk
Box	Regular	0929DPOCHR	0929000CHR	5.8/10.7
Box	Reverse	1029DPOCHR	1029000CHR	5.8/10.7
Flush	Regular	0968DPOCHR	0968000CHR	5.6/10.3
Flush	Reverse	1068DPOCHR	1068000CHR	5.6/10.3

TECH INFO

Dimensions Case:
2" x 2-1/4"
Dimensions Escutcheon:
2" x 2-1/4"
Screw Size: #6

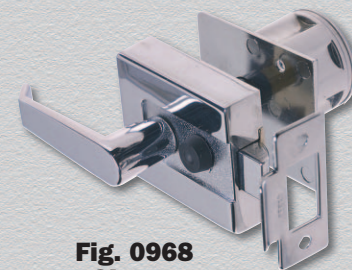

**Fig. 0968
Shown
Assembled**

SPARE PARTS ORDERING INFORMATION

Flush Strike: 0912DPOCHR Regular Bevel with Cam: 0984000CHR Box Strike: 0977000CHR
Reverse Bevel with Cam: 0920DPOCHR Knob and Handle Assembly: 0995000CHR

* Note: Refer to Page 225 to determine the proper hand of a lock or latch set.

LOCK & LATCH SETS

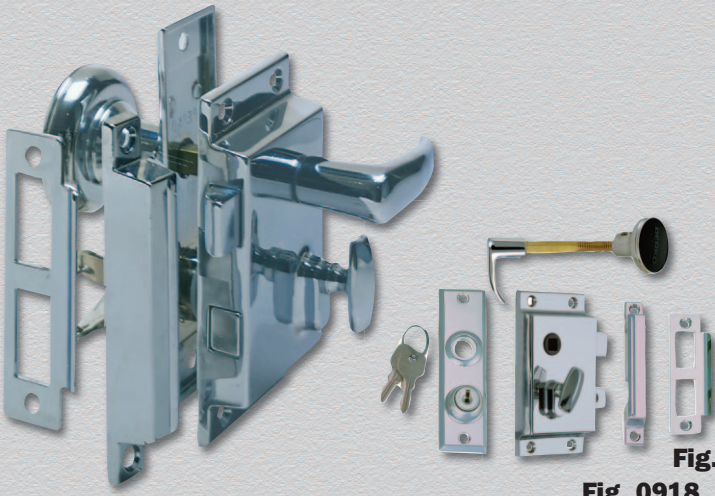

**Fig. 0918/0919
Shown
Assembled**

Figs. 0918 & 0919 - Rim Lock Sets

CONSTRUCTION:

- Chrome Plated Zinc Alloy
- For Door Thickness 5/8 to 1-3/8 Inches

Fig. 0918 - Regular Bevel with Box Strike
Fig. 0919 - Reverse Bevel with Flush Strike

Locks by Turn Button from Inside or Key from Outside

Fig. 0919

Fig. 0918

ORDERING INFO				TECH INFO
Door Bevel/Strike Type	Dealer Pkg. 5 Sets 1 Set per Card	OEM Bulk Pkg. 10 Sets	Ship Wt. Carton Lbs. DP/OEM Bulk	Dimensions Case: 3-7/8" x 2" Dimensions Escutcheon: 4-3/8" x 1-1/4" Screw Size: #6
Regular w/Box	0918DPOCHR	0918000CHR	7.0/12.9	
Reverse w/Flush	0919DPOCHR	0919000CHR	6.9/12.5	

SPARE PARTS ORDERING INFORMATION

Box Strike: 091800099A
 Flush Strike: 0913DPOCHR
 Knob and Handle Assembly: 0962000CHR
 Regular Bevel with Cam: 0984000CHR
 Reverse Bevel with Cam: 0920DPOCHR
 Escutcheon Plate with Keys: 0953000CHR

Figs. 1279 & 1280 - Flush Cup Rim Latch Sets

**Fig. 1279
Shown
Assembled**



Fig. 1279

Fig. 1280

CONSTRUCTION:

- Chrome Plated Zinc Alloy
- Sliding Lock Button
- For Door Thickness 3/4 to 1-1/8 Inches

Fig. 1279 - Regular Bevel with Box Strike
Fig. 1280 - Reverse Bevel with Flush Strike

Supplied with Black Polymer Spacer for Surface Mounting

ORDERING INFO				TECH INFO
Bevel/Strike Type	Dealer Pkg. 5 Sets 1 Set per Card	OEM Bulk Pkg. 10 Sets	Ship Wt. Carton Lbs. DP/OEM Bulk	Dimensions Case: 2-1/8" x 1-3/4" Dimensions Escutcheon: 2" x 2-1/4" Cup Screw Size: #8 Case Screw Size: #6
Regular w/Box	1279DPOCHR	1279000CHR	4.1/7.2	
Reverse w/Flush	1280DPOCHR	1280000CHR	4.0/6.9	

SPARE PARTS ORDERING INFORMATION

Box Strike: 0976000CHR
 Flush Strike: 0912DPOCHR
 Regular Bevel with Cam: 0984000CHR
 Reverse Bevel with Cam: 0920DPOCHR

* Note: Refer to Page 225 to determine the proper hand of a lock or latch set.

Fig. 0927 - Mortise Lock Set

CONSTRUCTION:

- Chrome Plated Zinc Alloy

Locks by Turn Button from Inside or Key from Outside
Bevel can be Reversed During Installation

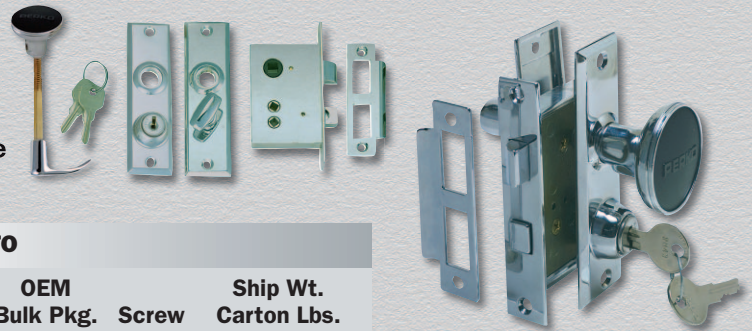

**Fig. 0927
Shown
Assembled**

ORDERING & TECH INFO

For Door Thickness Inches	Dimensions Case Inches	Dimensions Escutcheon Inches	Dealer Pkg. 5 Sets 1 Set per Card	OEM Bulk Pkg. 10 Sets	Screw Size	Ship Wt. Carton Lbs. DP/OEM Bulk
1 to 1-3/8	2-3/4 x 2	4-3/8 x 1-1/4	0927DPOCHR	0927000CHR	6	7.1/13.0

SPARE PARTS ORDERING INFORMATION

Spare Flush Strike: 0913DPOCHR Bevel with Cam: 0920DPOCHR
Spare Knob and Handle Assy: 0962000CHR Escutcheon Plate with Keys: 092700099B

Fig. 0960 - Mortise Latch Set

CONSTRUCTION:

- Chrome Plated Zinc Alloy
- Turn Button Lock

Bevel can be Reversed During Installation

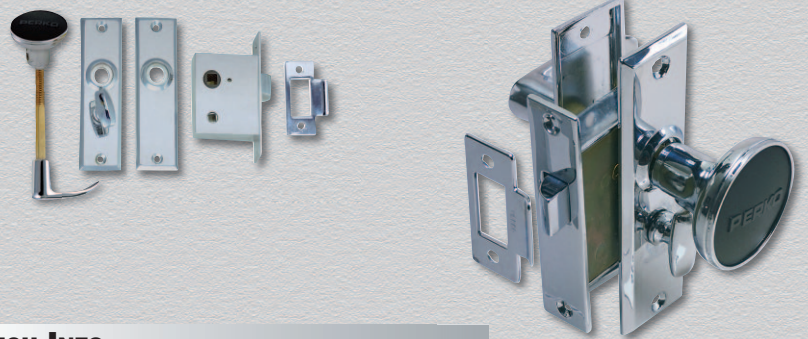

**Fig. 0960
Shown
Assembled**

ORDERING & TECH INFO

For Door Thickness Inches	Dimensions Case Inches	Dimensions Escutcheon Inches	Dealer Pkg. 5 Sets 1 Set per Card	OEM Bulk Pkg. 10 Sets	Screw Size	Ship Wt. Carton Lbs. DP/OEM Bulk
1 to 1-3/8	2-1/4 x 1-13/16	4-3/8 x 1-1/4	0960DPOCHR	0960000CHR	6	5.9/10.6

SPARE PARTS ORDERING INFORMATION

Flush Strike: 0912DPOCHR Bevel with Cam: 096000099A
Knob and Handle Assembly: 0962000CHR

Fig. 0567 - Tubular Latch Set

CONSTRUCTION:

- Chrome Plated Zinc Alloy
- Sliding Lock Button



**Fig. 0567
Shown
Assembled**

ORDERING & TECH INFO

For Door Thickness Inches	Dimensions Escutcheon Inches	O.D. Tube Inches	Dealer Pkg. 5 Cards 1 Set per Card	OEM Bulk Pkg. 10 Sets	Screw Size	Ship Wt. Carton Lbs. DP/OEM Bulk
1 to 1-3/8	4-3/8 x 1-1/4	3/4	0567DPOCHR	0567000CHR	6	4.5/8.1

SPARE PARTS ORDERING INFORMATION

Flush Strike: 0912DPOCHR
Knob and Handle Assembly: 0962000CHR

RECTANGULAR FLUSH HATCH DOGS

NEW
Item*



Fig. 0777F
Latch
with Concealed
Fasteners

Fig. 0777 - Rectangular Flange Flush Hatch Dog

CONSTRUCTION:

- Chrome Plated Bronze
- Latch or Locking Versions
- **2 Options:** Flange With Visible Mounting Holes or Smooth Flange with Concealed Fasteners
- Stainless Steel Lock Nuts
- Flush Strike
- O-Ring Seals for Water Resistance
- Does Not Rattle When “Dogged” Down

For Securely “Dogging” (Fastening) Deck Hatches

9



Fig. 0777FL
Lock
with Concealed
Fasteners



Fig. 0777L
Lock
with Mounting
Holes



Fig. 0777
Latch
with Mounting
Holes
Shown in Marinium

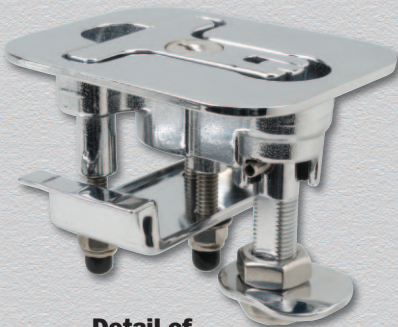

**Detail of
Concealed Fasteners
Bottom Plate**

ORDERING INFO

Type	Cam Bar Length Inches	Std. Pkg. - 1 Pc. OEM Pkg. - 5 Pcs.	Ship Wt. Carton Lbs. Std. Pkg.
Visible Mounting Holes			
Latch	15/16	0777000CHR	1.2
Latch	1-1/2	0777001CHR	1.2
Latch	3	0777002CHR	1.2
Lock	15/16	0777L00CHR**	1.4
Lock	1-1/2	0777L01CHR**	1.4
Lock	3	0777L02CHR**	1.4
Concealed Fasteners*			
Latch	15/16	0777F00CHR	1.5
Latch	1-1/2	0777F01CHR	1.5
Latch	3	0777F02CHR	1.5
Lock	15/16	0777FLOCHR**	1.7
Lock	1-1/2	0777FL1CHR**	1.7
Lock	3	0777FL2CHR**	1.7

* Std. Pkg 1 Pc.

** New Item

SPARE PARTS ORDERING INFORMATION

Cam Bar for Size #0: 077700099A
Cam Bar for Size #1: 077700199A
Cam Bar for Size #2: 077700299A

ALSO AVAILABLE IN



Contact Factory



Strike

TECH INFO

Max. Hatch Thickness: 2"
Adjustment Cam Bar: 1-1/4" to 2"
Dimensions Face Plate: 3-13/16" x 3"
Screw Size: #8

CAM BAR OPTIONS

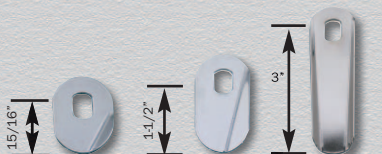

Fig. 0777 #0
Cam Bar

Fig. 0777 #1
Cam Bar

Fig. 0777 #2
Cam Bar

PERKO® ROUND FLUSH HATCH DOGS

Fig. 0778 - Round Flange Flush Hatch Dog

CONSTRUCTION:

- Chrome Plated Bronze
- Latch or Locking Versions
- **2 Options:** Flange With Visible Mounting Holes or Smooth Flange with Concealed Fasteners
- Stainless Steel Lock Nuts
- Flush Strike
- O-Ring Seals for Water Resistance
- Does Not Rattle When “Dogged” Down

For Securely “Dogging” (Fastening) Deck Hatches



Fig. 0778FL
Lock with
Concealed
Fasteners



Fig. 0778L
Lock with
Mounting Holes



Fig. 0778
Latch with
Mounting Holes



Fig. 0778F
Latch with
Concealed
Fasteners



**Detail of
Concealed Fasteners
Bottom Plate**

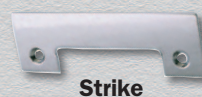

Strike

ORDERING INFO

Type	Cam Bar Length Inches	Std. Pkg. - 1 Pc.	Ship Wt. Carton Lbs. Std. Pkg.
Visible Mounting Holes			
Latch	1-1/2	0778001CHR	1.4
Latch	3	0778002CHR	1.5
Lock	1-1/2	0778L01CHR*	1.6
Lock	3	0778L02CHR*	1.7
Concealed Fasteners			
Latch	1-1/2	0778F01CHR	1.6
Latch	3	0778F02CHR	1.6
Lock	1-1/2	0778FL1CHR*	1.9
Lock	3	0778FL2CHR*	1.9

TECH INFO

Max. Hatch Thickness: 2"
 Adjustment Cam Bar: 1-1/4" to 2"
 Diameter Face Plate: 4-3/8"
 Screw Size: #8

CAM BAR OPTIONS



Fig. 0777
#1 Cam Bar

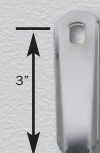

Fig. 0777#2
Cam Bar

* New Item

SPARE PARTS ORDERING INFORMATION

Cam Bar for Size #1: 077700199A
 Cam Bar for Size #2: 077700299A

CUPBOARD BOLT, CATCH, TURN & LATCH



Fig. 1101

Fig. 1101 - Cupboard Bolt

CONSTRUCTION:

- Chrome Plated Zinc Alloy
- Black Polymer Slide and Knob

ORDERING & TECH INFO				
Dimensions Overall Inches	Dealer Pkg. 5 Cards 1 Pc. per Card	OEM Bulk Pkg. 50 Pcs.	Screw Size	Ship Wt. Carton Lbs. DP/OEM Bulk
2-1/8 x 1-1/2	1101DPOCHR	1101000CHR	6	0.6/6.7

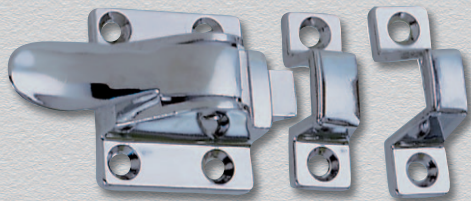

Fig. 1102

Fig. 1102 - Cupboard Catch

CONSTRUCTION:

- Chrome Plated Zinc Alloy

No. 1 Supplied with Box Strike
No. 2 Supplied with 3/8 Inch Offset Box Strike

Spacer Included with 1102DP2CHR Package to Allow for Additional (3/16") Offset

3/16" Spacer for use with #2 Offset Box Strike



ORDERING & TECH INFO					
Strike Type	Dimensions Overall Inches	Dealer Pkg. 5 Cards 1 Pc. per Card	OEM Bulk Pkg. 50 Pcs.	Screw Size	Ship Wt. Carton Lbs. DP/OEM Bulk
Box	1-1/2 x 1-7/8	1102DP1CHR	1102001CHR	6	1.4/10.6
Offset Box	1-1/2 x 1-7/8	1102DP2CHR	1102002CHR	6	1.5/10.9



Fig. 0978

Fig. 0978 - Cupboard Turn

CONSTRUCTION:

- Chrome Plated Zinc Alloy

ORDERING & TECH INFO			
Dimensions Overall Inches	Dealer Pkg. 5 Cards 1 Pc. per Card	Screw Size	Ship Wt. Carton Lbs. Dealer Pkg.
2-1/8 x 2-1/4	0978DPOCHR	6	2.0

SPARE PARTS ORDERING INFORMATION

Strike Plate: 0976000CHR Bevel with Cam: 0984000CHR

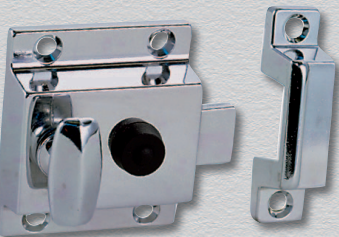

Fig. 0948

Fig. 0948 - Latch

CONSTRUCTION:

- Chrome Plated Zinc Alloy
- Sliding Lock Button

ORDERING & TECH INFO			
Dimensions Overall Inches	Dealer Pkg. 5 Cards 1 Pc. per Card	Screw Size	Ship Wt. Carton Lbs. Dealer Pkg.
2-1/8 x 2-1/4	0948DPOCHR	6	2.0

SPARE PARTS ORDERING INFORMATION

Strike Plate: 0976000CHR Bevel with Cam: 0984000CHR

CABINET LOCK AND LATCH, LATCH ASSEMBLY & ELBOW CATCHES

Figs. 0921 & 0922 - Cabinet Flush Lock & Latch

CONSTRUCTION:

- Chrome Plated Zinc Alloy

Fig. 0921 - Lock with 2 Keys

Fig. 0922 - Non-Locking Latch

Easily Installs in a 1-5/8 Inch Diameter Hole

For Door Thickness 1/2 to 3/4 Inch

Fig. 0921
Shown



ORDERING & TECH INFO

Type	Dimensions Face Plate Inches	Dealer Pkg. - 5 Cards 1 Pc. per Card	OEM Bulk Pkg. 25 Pcs.	Ship Wt. Carton Lbs. DP/OEM Bulk
Lock	2-1/4 x 2	0921DPOCHR	0921000CHR	2.8/12.6
Latch	2-1/4 x 2	0922DPOCHR	0922000CHR	2.5/11.2

Chrome Cam Bar: 0980A

Note: Chrome and Polymer Cam Bars are not interchangeable.

Fig. 0938 - Pull and Latch Assembly

CONSTRUCTION:

- Chrome Plated Zinc Alloy
- Black Polymer Insert
- Brass Stem

9



Fig. 0938

ORDERING & TECH INFO

O.D. Knob Inches	Max. Panel Thickness Inches	Dealer Pkg. - 5 Cards 1 Pc. per Card	OEM Bulk Pkg. 50 Pcs.	Ship Wt. Carton Lbs. DP/OEM Bulk
1-1/2	1-1/8	0938DPOCHR	0938000CHR	0.9/5.3

SPARE PARTS ORDERING INFORMATION

Cam Bar: 093800099A

Fig. 1056 - Elbow Catch

CONSTRUCTION:

- Chrome Plated Zinc Alloy
- Stainless Steel Spring



Fig. 1056

ORDERING & TECH INFO

Dimensions Inches	Dealer Pkg. - 10 Cards 1 Pc. per Card	OEM Bulk Pkg. 50 Pcs.	Screw Size	Ship Wt. Carton Lbs. DP/OEM Bulk
1-1/8 x 9/16	1056DPOCHR	1056000CHR	6	1.1/3.3

Fig. 1021 - Elbow Catch

CONSTRUCTION:

- Black Polymer
- Integral Spring

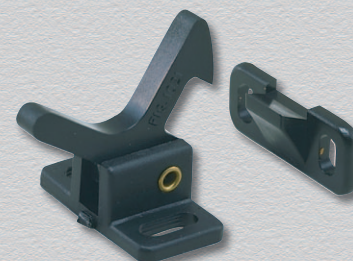

Fig. 1021

ORDERING & TECH INFO

Dimensions Inches	Dealer Pkg. - 25 Cards 2 Pcs. per Card	OEM Bulk Pkg. 100 Pcs.	Screw Size	Ship Wt. Carton Lbs. DP/OEM Bulk
1-3/16 x 5/8	1021DPOBLK	1021000BLK	6	1.9/1.9

FLUSH RING CATCH, KNOBS AND "T" HANDLE FLUSH PULL

Fig. 1051 - Flush Ring Catch

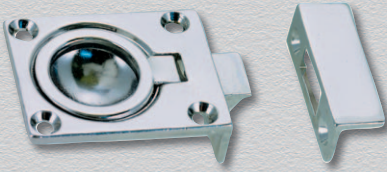

Fig. 1051

CONSTRUCTION:

- Chrome Plated Zinc Alloy
- Phosphor Bronze Spring

ORDERING & TECH INFO

Dimensions Inches	Dealer Pkg. - 10 Cards 1 Pc. per Card	OEM Bulk Pkg. 25 Pcs.	Screw Size	Ship Wt. Carton Lbs. DP/OEM Bulk
2-1/4 x 1-3/8	1051DPOCHR	1051000CHR	6	1.7/3.2

Figs. 0925 & 0926 - Knobs

CONSTRUCTION:

- Stainless Steel Screw

Fig. 0925

- Chrome Plated Brass

Fig. 0926

- Chrome Plated Zinc Alloy
- Black Polymer Insert



Fig. 0925



Fig. 0926

ORDERING & TECH INFO

O.D. Knob Inches	Max. Panel Thickness Inches	Dealer Pkg. - 10 Cards 1 Pc. per Card	OEM Bulk Pkg. 50 Pcs.	Ship Wt. Carton Lbs. DP/OEM Bulk
1	1-1/8	0925DPOCHR	0925000CHR	1.5/5.0
1-1/8	1-1/8	0926DPOCHR	0926000CHR	0.9/2.0
1-1/2	1-1/8	0926DP1CHR	0926001CHR	1.0/2.5

Fig. 1093 - "T" Handle Flush Pull

For Smooth and Carpeted Surfaces

Gasket Included for Smooth Surface Applications

Toothed Back for Carpet Surface Applications

CONSTRUCTION:

- Black or White Polymer Body
- Chrome Plated Zinc Alloy, Black or White Polymer "T" Handle
- Stainless Steel Stem

**Easily Installs in a 2-1/2 Inch Diameter Hole
For Mounting Surfaces 1/8 to 3/4 Inch Thick**



Fig. 1093

See Pages 220 & 221
for Matching
Lock & Latch Sets

ORDERING & TECH INFO

Color Body	Color Handle	Diameter Inches	OEM Bulk Pkg. 25 Pcs.	Ship Wt. Carton Lbs. OEM Bulk
Black	Black	3	1093000BLK	9.0
Black	Chrome	3	1093000CHR	10.2
White	White	3	1093000WHT	7.5

Fig. 1221 - Flush Pull

CONSTRUCTION:

- Chrome Plated Zinc Alloy
- Black Polymer Finishing Flange

Spring Loaded, Can be Mounted Horizontally or Vertically

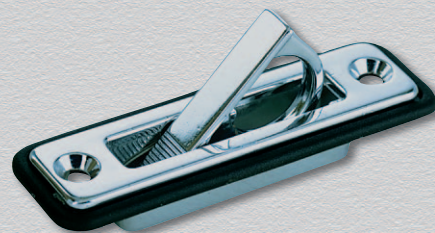

Fig. 1221

ORDERING & TECH INFO

Dimensions Flange Inches	Dealer Pkg. 5 Cards 1 Pc. per Card	OEM Bulk Pkg. 50 Pcs.	Screw Size	Ship Wt. Carton Lbs. DP/OEM Bulk
3/4 x 3-1/4	1221DPOCHR	1221000CHR	8	1.0/6.8

Fig. 0776 - Flush Lifting Handle

CONSTRUCTION:

- Chrome Plated Bronze

Size No. 2 (Not Shown) Has All Mounting Holes at Corners



Fig. 0776

ORDERING & TECH INFO

Dimensions Face Plate Inches	Dimensions Inside Handle Inches	Dealer Pkg. 5 Cards 1 Pc. per Card	OEM Bulk Pkg. 25 Pcs.	Screw Size	Ship Wt. Carton Lbs. DP/OEM Bulk
3 x 2-1/4	1-7/8 x 1	0776DP1CHR	0776001CHR	8	2.1/8.9
3-3/4 x 2-3/4	2-3/16 x 1-3/16	0776DP2CHR	0776002CHR	8	3.2/13.2

ALSO AVAILABLE IN



Fig. 1220 - Flush Lifting Handle

CONSTRUCTION:

- Chrome Plated Zinc Alloy



Fig. 1220

ORDERING & TECH INFO

Dimensions Face Plate Inches	Dimensions Inside Handle Inches	Dealer Pkg. 5 Cards 1 Pc. per Card	OEM Bulk Pkg. 50 Pcs.	Screw Size	Ship Wt. Carton Lbs. DP/OEM Bulk
3 x 2-1/4	1-7/8 x 1	1220DPOCHR	1220000CHR	8	1.5/12.4



Fig. 0841

Fig. 0841 - Flush Ring Pull

CONSTRUCTION:

- Chrome Plated Zinc Alloy

ORDERING & TECH INFO

Dimensions Face Plate Inches	Dealer Pkg. - 10 Cards 1 Pc. per Card	OEM Bulk Pkg. 50 Pcs.	Screw Size	Ship Wt. Carton Lbs. DP/OEM Bulk
1-3/4 x 1-3/8	0841DPOCHR	0841000CHR	6	1.3/4.2

Fig. 1232 - Flush Ring Pull

CONSTRUCTION:

- Chrome Plated Zinc Alloy



Fig. 1232

ORDERING & TECH INFO

O.D. Face Plate Inches	Dealer Pkg. - 5 Cards 1 Pc. per Card	OEM Bulk Pkg. 50 Pcs.	Screw Size	Ship Wt. Carton Lbs. DP/OEM Bulk
1-5/8	1232DP1CHR	1232001CHR	6	0.7/3.5
2	1232DP2CHR	1232002CHR	6	0.8/4.7

Fig. 1103 - Flush Ring Pull

CONSTRUCTION:

- Chrome Plated Bronze



Fig. 1103

ORDERING & TECH INFO

Dimensions Face Plate Inches	Dealer Pkg. - 5 Cards 1 Pc. per Card	OEM Bulk Pkg. 50 Pcs.	Screw Size	Ship Wt. Carton Lbs. DP/OEM Bulk
2-9/16 x 2	1103DPOCHR	1103000CHR	8	1.5/12.2

Fig. 0575 - Flush Lifting Pull

CONSTRUCTION:

- Chrome Plated Bronze



Fig. 0575

ORDERING & TECH INFO

Dimensions Face Plate Inches	Dealer Pkg. - 10 Cards 1 Pc. per Card	OEM Bulk Pkg. 50 Pcs.	Screw Size	Ship Wt. Carton Lbs. DP/OEM Bulk
2-5/8 x 2	0575DPOCHR	0575000CHR	8	2.8/10.8

PULLS & SLIDING WINDOW HANDLE

Fig. 1110 - Flush Pull

CONSTRUCTION:

- Chrome Plated Zinc Alloy



Fig. 1110

ORDERING & TECH INFO

Dimensions Face Plate Inches	Depth Inches	Dealer Pkg. 5 Cards 1 Pc. per Card	OEM Bulk Pkg. 50 Pcs.	Screw Size	Ship Wt. Carton Lbs. DP/OEM Bulk
3-11/16 x 1-11/16	7/16	1110DPOCHR	1110000CHR	6	1.3/10.4

Fig. 1016 - Flush Pull

CONSTRUCTION

- Black or White Polymer
- Easily Installs in a 1-3/4 Inch Diameter Hole



Fig. 1016
White



Fig. 1016
Black

ORDERING & TECH INFO

Color	Dimensions Face Plate Inches	Depth Inches	Dealer Pkg. 10 Cards 1 Pc. per Card	OEM Bulk Pkg. 100 Pcs.	Screw Size	Ship Wt. Carton Lbs. DP/OEM Bulk
Black	2-1/4 x 2-1/4	15/16	1016DPOBLK	1016000BLK	6	1.0/4.7
White	2-1/4 x 2-1/4	15/16	1016DPOWHT	1016000WHT	6	1.0/4.7



Fig. 0958 - Pull

CONSTRUCTION:

- Chrome Plated Zinc Alloy



Fig. 0958

ORDERING & TECH INFO

Width Overall Inches	Width Inside Inches	Dealer Pkg. 10 Cards 1 Pc. per Card	Screw Size	Ship Wt. Carton Lbs. Dealer Pkg.
3-7/16	2-5/16	0958DPOCHR	6	1.4

Fig. 0954 - Sliding Window Handle

CONSTRUCTION:

- Stainless Steel



Fig. 0954

ORDERING & TECH INFO

For Glass Thickness Inches	Length Overall Inches	Dealer Pkg. - 5 Cards 1 Pc. per Card	Ship Wt. Carton Lbs. Dealer Pkg.
1/4	3	0954DPOSTS	0.7

DOOR STOP, WINDOW STOP, LOCKS & FASTENER

Figs. 0935 & 0966 - Sliding Window & Door Stops



Fig. 0935

Fig. 0966

CONSTRUCTION:

- Polymer Cover on Stopping Plate

Fig. 0935 - For Sliding Windows

- Chrome Plated Zinc Alloy

Fig. 0966 - For Sliding Doors

- Chrome Plated Heavy Gauge Extruded Brass

ORDERING & TECH INFO

Dimensions Mounting Plate Inches	Length Stopping Plate Inches	Dealer Pkg. 5 Cards 1 Pc. per Card	OEM Bulk Pkg.	OEM Bulk Pkg. Qty	Screw Size	Ship Wt. Carton Lbs. DP/OEM Bulk
1-7/8 x 3/4	1-1/2	0935DPOCHR	0935000CHR	50	8	1.0/6.6
1-1/2 x 3/4	2	0966DPOCHR	0966000CHR	25	10	1.4/5.8

9

Figs. 0934 & 0937- Sliding Window Locks & Anti-Rattlers



Fig. 0937

CONSTRUCTION:

- Chrome Plated Zinc Alloy
- Black Polymer Knob and Tip

ORDERING & TECH INFO

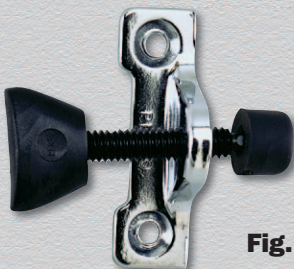

Fig. 0934

Height Overall Inches	Dimensions Mounting Plate Inches	Adjustment Inches	Dealer Pkg. 5 Cards 1 Pc. per Card	Screw Size	Ship Wt. Carton Lbs. Dealer Pkg.
1	2 x 5/8	1-1/8	0934DPOCHR	6	0.7
1-5/8	1 x 5/8	1-1/8	0937DPOCHR	6	0.6

SPARE PARTS ORDERING INFORMATION

Black Polymer Tip: 0944

Fig. 0719 - Removable Angled Fastener Ideal for Table Legs



Fig. 0719

CONSTRUCTION:

- Chrome Plated Brass
- Black Polymer Knob with Stainless Steel Stud

ORDERING & TECH INFO

Length Angle Inches	Width Angle Inches	Dealer Pkg. 5 Cards 1 Pc. per Card	OEM Bulk Pkg. 25 Pcs.	Screw Size	Ship Wt. Carton Lbs. DP/OEM Bulk
1-3/8	1	0719DPOCHR	0719000CHR	8	1.2/4.6

SPARE PARTS ORDERING INFORMATION

Knob: 071900099A

Single Bracket: 071900099B

Flat Plate: 071900099C

Fig. 0148 - Table Brackets

CONSTRUCTION:

- Chrome Plated Brass

For Removable Tables

Supplied in Sets of Two Brackets and Two Wall Plates

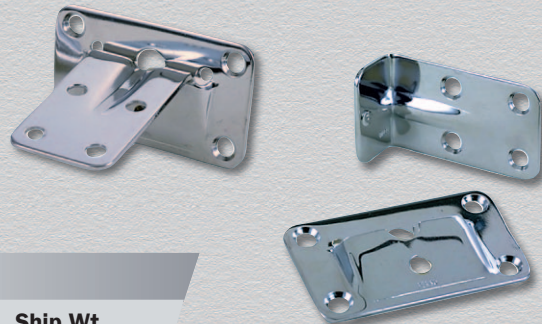

Fig. 0148

ORDERING & TECH INFO

Dimensions Angle Bracket Inches	Dimensions Wall Plate Inches	Dealer Pkg. 5 Cards 1 Set per Card	OEM Bulk Pkg. 25 Sets	Screw Size	Ship Wt. Carton Lbs. DP/OEM Bulk
2-3/4 x 1-11/16	3-3/8 x 2	0148DP0CHR	0148000CHR	10	4.3/19.7

SPARE PARTS ORDERING INFORMATION

Pair of Angle Brackets: 014800099A
Pair of Wall Plates: 014800099B

Fig. 1106 - Utility Hook

CONSTRUCTION:

- Chrome Plated Zinc Alloy



Fig. 1106

ORDERING & TECH INFO

Projection Inches	Width Base Inches	Dealer Pkg. 10 Cards 1 Pc. per Card	OEM Bulk Pkg. 50 Pcs.	Screw Size	Ship Wt. Carton Lbs. DP/OEM Bulk
3/4	1	1106DP0CHR	1106000CHR	6	1.0/2.8

Fig. 0975 - Utility Hook

CONSTRUCTION:

- Chrome Plated Zinc Alloy



Fig. 0975

ORDERING & TECH INFO

Projection Inches	Width Base Inches	Dealer Pkg. 10 Cards 1 Pc. per Card	OEM Bulk Pkg. 50 Pcs.	Screw Size	Ship Wt. Carton Lbs. DP/OEM Bulk
2	1-1/8	0975DP1CHR	0975001CHR	6	1.1/3.2
3	1-1/4	0975DP2CHR	0975002CHR	6	1.5/4.6

Fig. 0610 - Utility Hook

CONSTRUCTION:

- Chrome Plated Zinc Alloy



Fig. 0610

ORDERING & TECH INFO

Projection Inches	Width Base Inches	Dealer Pkg. 10 Cards 1 Pc. per Card	OEM Bulk Pkg. 50 Pcs.	Screw Size	Ship Wt. Carton Lbs. DP/OEM Bulk
1-3/8	1-1/8	0610DP0CHR	0610000CHR	6	0.9/2.2

UTILITY HOOK, BOAT COVER SOCKETS & FASTENERS



Fig. 1249

Fig. 1249 - Utility Hook

CONSTRUCTION:

- Chrome Plated Zinc Alloy

ORDERING & TECH INFO						
Length Overall Inches	Width Overall Inches	Inside Hook Inches	Dealer Pkg. 10 Cards 5 Pcs. per Card	OEM Bulk Pkg. 100 Pcs.	Screw Size	Ship Wt. Carton Lbs. DP/OEM Bulk
15/16	1/2	1/4	1249DPOCHR	1249000CHR	6	1.3/1.6



Fig. 0578

Fig. 0578 - Boat Cover Sockets

CONSTRUCTION:

- Chrome Plated Zinc Alloy

Will Accommodate 3/8 Inch Wood or Polymer Battens Up To 1-3/4 Inches Long

ORDERING & TECH INFO						
Length Overall Inches	Dimensions Opening Inches	Width Overall Inches	Dealer Pkg. 10 Cards 1 Pair per Card	Screw Size	Ship Wt. Carton Lbs. Dealer Pkg.	
3-1/4	1-7/8 x 7/16	5/8	0578DPOCHR	6	2.2	



Stud Fig. 0869

Button Fig. 0896

Figs. 0869, 0896, 0898, 0901 & 0907 "Durable Type" Fasteners

CONSTRUCTION:

Figs. 0896, 0898, 0901 & 0907 - Nickel Plated Brass
 Fig. 0869 - Stainless Steel, 5/8 Inch Self Tapping Screw

For Canvas to Surface, Use Figs. 0869, 0896 and 0898
 For Canvas to Canvas, Use Figs. 0896, 0898, 0901 & 0907

ORDERING & TECH INFO		
Description	Standard Pkg. - 100 Pcs.	Ship Wt. Carton Lbs. Std. Pkg.
Stud	0869000STS	0.7
Stud	0901000NKL	0.2
Socket	0898000NKL	0.8
Button	0896000NKL	0.4
Eyelet	0907000NKL	0.2



Socket Fig. 0898

Stud Fig. 0901

Eyelet Fig. 0907



Washer Fig. 0997

Eyelet Fig. 0996

Flanged Stud Fig. 0994

Figs. 0994, 0996 & 0997 - Curtain Fasteners

CONSTRUCTION:

- Nickel Plated Brass

ORDERING & TECH INFO		
Description	Standard Pkg. - 100 Pcs.	Ship Wt. Carton Lbs. Standard Pkg.
Flanged Stud	0994000NKL	1.5
Eyelet	0996000NKL	0.6
Washer	0997000NKL	0.2

Fig. 0447 - Fishing Rod Holder Vertical Flush Mount

CONSTRUCTION:

- Chrome Plated Bronze Flange
- Stainless Steel Tube
- Hard Black Polymer Liner
- Integral Flip-Up Cap

D01 & DPD - Integral Drain Bib for 5/8 Inch I.D. Flexible Hose

ALSO AVAILABLE IN
MARINIUM
Contact Factory

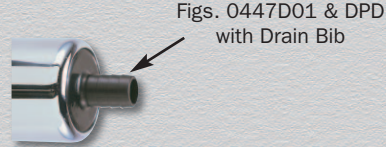

Figs. 0447D01 & DPD
with Drain Bib



Fig. 0447

ORDERING & TECH INFO

Mount Type	Drain Bib	I.D. Tube Inches	O.D. Tube Inches	Length Under Flange Inches	Dimensions Flange Inches	Dealer Pkg. 5 Pkgs. 1 Pc. per Pkg.	OEM Bulk Pkg. 10 Pcs.	Bolt Size	Ship Wt. Carton Lbs. DP/OEM Bulk
Vertical	No	1-5/8	2	9	3-1/2 O.D.	0447DP1CHR	0447001CHR	10	8.4/15.8
Vertical	Yes	1-5/8	2	10-1/2	3-1/2 O.D.	0447DPDCHR	0447D01CHR	10	8.1/15.7

Fig. 0448 - Fishing Rod Holder Angled Flush Mount (Approximate 65°)

CONSTRUCTION:

- Chrome Plated Bronze Flange
- Chrome Plated Brass Tube

Fig. 0448 No. 1 - Soft Black Liner and Flange Gasket w/Integral Flip-Up Cap

Fig. 0448 No. 2 - Soft Black Liner with Lip Only

D01 & DPD - Integral Drain Bib for 5/8 Inch I.D. Flexible Hose

Figs. 0448D01 & DPD
With Drain Bib



Fig. 0448D01

Fig. 0448
Shown in
Marinium

10

ORDERING & TECH INFO

Mount Type	Drain Bib	I.D. Tube Inches	O.D. Tube Inches	Length Under Flange Inches	Dimensions Flange Inches	Dealer Pkg. 5 Pkgs. 1 Pc. per Pkg.	OEM Bulk Pkg. 10 Pcs.	Ship Wt. Carton Lbs. DP/OEM Bulk
Angled	No	1-5/8	2	8	4-1/4 x 3-1/2	0448DP1CHR	0448001CHR	11.3/21.8
Angled	Yes	1-5/8	2	9-1/2	4-1/4 x 3-1/2	0448DPDCHR	0448D01CHR	11.0/21.7
Angled	No	1-7/8	2-1/4	12	4-7/8 x 4	0448DP2CHR*	—	3.4/-

*Dealer Pkg. - 1 card, 1 pc. per card. Bolt Size 1/4.

ALSO AVAILABLE IN
MARINIUM
Contact Factory

Fig. 0452 - Fishing Rod Holder Angled Flush Mount (Approximate 65°)

CONSTRUCTION:

- Polished Stainless Steel Flange
- Stainless Steel Tube and Soft Black Liner
- Flange Gasket with Integral Flip-Up Cap

D01 & DPD - Integral Drain Bib for 5/8 Inch I.D. Flexible Hose

Rounded Rod
Holder Bottom



Figs. 0452D01 & DPD
with Drain Bib

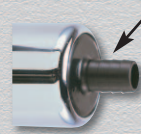

Fig. 0452

ORDERING & TECH INFO

Mount Type	Drain Bib	I.D. Tube Inches	O.D. Tube Inches	Length Under Flange Inches	Dimensions Flange Inches	Dealer Pkg. 5 Pkgs. 1 Pc. per Pkg.	OEM Bulk Pkg. 10 Pcs.	Ship Wt. Carton Lbs. DP/OEM Bulk
Angled	No	1-5/8	2	8-1/4	4-1/8 x 3-3/8	0452DPOSTS	0452000STS	6.5/12.5
Angled	Yes	1-5/8	2	9-3/4	4-1/8 x 3-3/8	0452DPDSTS	0452D01STS	6.7/12.7

Bolt Size #10.

SPARE PARTS ORDERING INFORMATION

For spare parts for all rod holders on this page, see pg. 248.

FISHING ROD HOLDERS



Fig. 1205

Figs. 1205D01 & DPD with Drain Bib

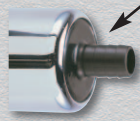

Fig. 1205 - Fishing Rod Holder Angled Flush Mount (Approximate 65°)

CONSTRUCTION:

- Chrome Plated Zinc Alloy Flange
- Anodized Aluminum Tube
- Soft Black Liner
- Flange Gasket with Integral Flip-up Cap

D01 & DPD Integral Drain Bib for 5/8 Inch I.D. Flexible Hose

ORDERING & TECH INFO



Rounded Rod Holder Bottom

Mount Type	Drain Bib	I.D. Tube Inches	O.D. Tube Inches	Length Under Flange Inches	Dimensions Flange Inches	Dealer Pkg. 5 Pkgs. 1 Pc. per Pkg.	OEM Bulk Pkg. 20 Pcs. DP/OEM Bulk	Ship Wt. Carton Lbs.
Angled	No	1-5/8	2	8	4-1/4 x 3-1/2	1205DPOCHR	1205000CHR	8.2/29.7
Angled	Yes	1-5/8	2	9-1/2	4-1/4 x 3-1/2	1205DPDCHR	1205D01CHR	8.1/29.9

For spare parts see pg. 248.

Bolt Size 1/4"

Figs. 1099, 1100 and 1104 - Side Mount Fishing Rod Holders

10



Fig. 1099

Fig. 1100

Fig. 1104



Rounded Rod Holder Bottom

CONSTRUCTION:

- Chrome Plated Brass Brackets
- Fig. 1099 - Stainless Steel Tube
- Fig. 1100 - Chrome Plated Brass Tube
- Fig. 1104 - Black Polymer Tube
- Figs. 1099 and 1100 Hard Black Polymer Liner

ORDERING & TECH INFO

I.D. Tube Inches	O.D. Tube Inches	Length Overall Inches	Width Bracket Inches	Dealer Pkg. 5 Pkgs. 1 Pc. per Pkg.	Ship Wt. Carton Lbs. Dealer Pkg.
1-5/8	2	9	3	1099DPOSTS	6.1
1-5/8	2	9	3	1100DPOCHR	6.3
1-5/8	2	9	3-1/4	1104DPOBLK	3.2

Mounting Screw Size #8 R.H. Spare Brackets (Pr.): 1107000CHR

NOTE: The use of a safety line attached to the rod and reel is recommended, particularly when running or fishing with heavy duty rods and reels.

Fig. 0404 - Heavy Duty Side Mount Fishing Rod Holder

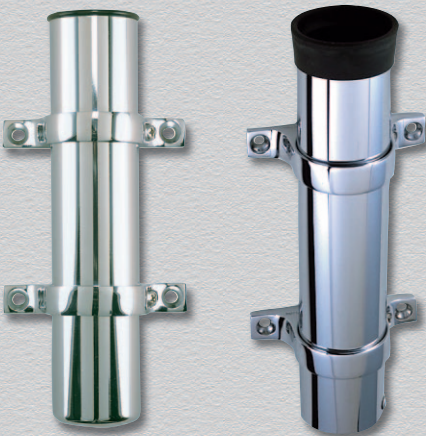

Fig. 0404 #1

Fig. 0404 #2



Size #1 Rounded Rod Holder Bottom

CONSTRUCTION:

- Chrome Plated Brass and Bronze
- Size #1 with Hard Black Polymer Liner
- Size #2 with Soft Black Lip & Liner

ORDERING & TECH INFO

I.D. Tube Inches	O.D. Tube Inches	Length Overall Inches	Width Bracket Inches	Dealer Pkg. - 5 Pkgs. 1 Pc. per Pkg.	Ship Wt. Carton Lbs. Dealer Pkg.
1-5/8	2	9	4-3/16	0404DP1CHR	10.2
1-7/8	2-1/4	11	4-3/4	0404DP2CHR*	3.3

Bolt Size 1/4".

* Dealer Pkg. - 1 card, 1 pc. per card.

SPARE PARTS ORDERING INFORMATION

Bracket for Size No. 1: 040400199A Bracket for Size No. 2: 040400299A
Liner with Lip and Tube for Size #2 See Fig. 0483DP2BLK on Page 248.

NOTE: The use of a safety line attached to the rod and reel is recommended, particularly when running or fishing with heavy duty rods and reels.

Fig. 1118 - Clamp-On Fishing Rod Holder

CONSTRUCTION:

- Chrome Plated Brass and Bronze
- Hard Black Polymer Liner
- Clamp-On Feature Eliminates Drilling Rail and Simplifies Relocation
- Mounts on Vertical or Horizontal Rails
- DPO Fits Rails 3/4 to 1 Inch in Diameter
 - Adjustable as Supplied for 7/8 to 1 Inch Rails
 - Adaptable to 3/4 Inch Rails by Reducing the Mounting Bolt Length
- DP2 Fits 1-1/4 Inch Diameter Rails

ORDERING & TECH INFO

For Rail Size Diameter	I.D. Tube Inches	O.D. Tube Inches	Length Overall Inches	Dealer Pkg. 5 Pcs. 1 Pc. per Pkg.	Ship Wt. Carton Lbs. Dealer Pkg.
3/4 to 1	1-5/8	2	9	1118DPOCHR	11.0
1-1/4	1-5/8	2	9	1118DP2CHR	10.6

SPARE PARTS ORDERING INFORMATION

Face Plate with Bolts for 1118DPOCHR: 111800099A
 Clamp Bracket with Bolts for 1118DP2CHR: 111800299A
 Intermediate Plate for 1118DPOCHR: 111800099B
 Intermediate Plate for 1118DP2CHR: 111800299B

NOTE: The use of a safety line attached to the rod and reel is recommended, particularly when running or fishing with heavy duty rods and reels.



Fig. 1118DPO for 3/4" to 1" Dia. Rails

Fig. 1118DP2CHR for 1-1/4" Dia. Rails

Rounded Rod Holder Bottom

10

Fig. 1215 - Clamp-On Fishing Rod Holder

CONSTRUCTION:

- Chrome Plated Zinc Alloy
- Polished Stainless Steel Tube
- Hard Black Polymer Liner
- Clamp-On Feature Eliminates Drilling Rail and Simplifies Relocation
- Mounts on Vertical or Horizontal Rails
- DPO Fits Rails 3/4 to 1 Inch in Diameter
 - Adjustable as Supplied for 7/8 to 1 Inch Rails
 - Adaptable to 3/4 Inch Rails by Reducing the Mounting Bolt Length
- DP2 Fits 1-1/4 Inch Diameter Rails

ORDERING & TECH INFO

For Rail Size Diameter	I.D. Tube Inches	O.D. Tube Inches	Length Overall Inches	Dealer Pkg. 5 Pcs. 1 Pc. per Pkg.	Ship Wt. Carton Lbs. Dealer Pkg.
3/4 to 1	1-5/8	2	9	1215DPOCHR	9.0
1-1/4	1-5/8	2	9	1215DP2CHR	8.4

SPARE PARTS ORDERING INFORMATION

Face Plate with Bolts for 1215DPOCHR: 1215DP099A
 Clamp Bracket with Bolts for 1215DP2CHR: 121500299A
 Intermediate Plate for 1215DPOCHR: 121500099B
 Intermediate Plate for 1215DP2CHR: 121500299B

NOTE: The use of a safety line attached to the rod and reel is recommended, particularly when running or fishing with heavy duty rods and reels.



Fig. 1215DPO for 3/4" to 1" Dia. Rails

Fig. 1215DP2CHR for 1-1/4" Dia. Rails

Rounded Rod Holder Bottom

FISHING ROD HOLDER & ACCESSORIES



Fig. 0449

Fig. 0449 - Removable Fishing Rod Holder

CONSTRUCTION:

- Chrome Plated Brass and Manganese Bronze
- Soft Black Liner

Designed for Vertical Mounting, This Holder is Easily Removed When Not in Use, Leaving No Projecting Hardware

ORDERING & TECH INFO

I.D. Tube Inches	O.D. Tube Inches	Dimensions Bracket Inches	Dealer Pkg. - 1 Card 1 Pc. per Card	Ship Wt. Carton Lbs. Dealer Pkg.
1-5/8	2	4 x 3-3/4	0449DPOCHR	3.2

Screw Size #10.

SPARE PARTS ORDERING INFORMATION

Holder Only: 044900099A
 Bracket Only: 044900099B
 Liner with Lip and Tube: 0483DP1BLK

10

Figs. 0480, 0481 & 0484 - Cap and Gasket Kits for Fishing Rod Holders



Fig. 0480

CONSTRUCTION:

- Soft Black Flange Gasket with Integral Flip-up Cap
- Soft Black Lip
- Replacement or Upgrade for Older Holders

ORDERING & TECH INFO

To Fit Catalog Number	Dealer Pkg. - 5 Cards 1 Kit per Card	Ship Wt. Carton Lbs. Dealer Pkg.
0448DP1CHR	0480DPOBLK	1.4
0447DP1CHR	0484DPOBLK*	0.8
0452DPOSTS	0481DPOBLK	1.4
1205DPOCHR	0480DPOBLK	1.4

* 0484DPOBLK has cap and gasket only.

Figs. 0482 & 0483 - Liners, Lips and Tubes For Fishing Rod Holders



Fig. 0482

Fig. 0483

Lip & Liner Cat. No.	Lip Only Cat. No.	Fits Rod Holders Listed Below						
		0448#1	0448D	0448#2	0452	1205	0449	0404#2
0482DP1BLK	0482DP199A	X	X		X	X		
0482DP2BLK	0482DP299A			X				
0483DP1BLK	0483DP199A						X	
0483DP2BLK	0483DP299A							X

ORDERING & TECH INFO

I.D. Inches	For Angled Flush Mount Complete Dealer Pkg. 5 Cards 1 Set per Card	For All Others Complete Dealer Pkg. 5 Cards 1 Set per Card	Spare Lip Only For Fig. 0482 Dealer Pkg. 5 Cards 1 Pc. per Card	Spare Lip Only For Fig. 0483 Dealer Pkg. 5 Cards 1 Pc. per Card
1-5/8	0482DP1BLK	0483DP1BLK	0482DP199A	0483DP199A
1-7/8	0482DP2BLK	0483DP2BLK	0482DP299A	0483DP299A

Fig. No.	Page No.	Fig. No.	Page No.	Fig. No.	Page No.	Fig. No.	Page No.
0004.....	66 & 85	0139.....	19	0240.....	51, 53, 54 & 72	0318.....	121
0005.....	66 & 85	0140.....	119	0241.....	25 & 72	0322.....	157
0007.....	66 & 85	0142.....	161	0244.....	124	0323.....	160
0024.....	66	0144.....	140	0245.....	124	0325.....	206
0030.....	70 & 170	0145.....	119	0247.....	21 & 72	0326.....	158, 160 & 161
0042.....		0148.....	243	0248.....	41, 48, 49 & 72	0327.....	160
134.....		0149.....	213	0249.....	82, 83, 87 & 88	0328.....	158
0052.....	66	0150.....	140	0250.....	65	0329.....	65
0061.....	114 to 116	0152.....	213	0252.....	21	0330.....	136
0063.....	155	0153.....	140	0253.....	18	0331.....	157
0064.....	25	0155.....	204	0254.....	14	0333.....	160
0065.....	151	0158.....	141	0256.....	65, 66, 84 to 86	0334.....	137
0066.....	151	0159.....	141		& 88	0335.....	137
0067.....	71 & 127	0162.....	139	0257.....	123 & 124	0336.....	137
0068.....	61	0163.....	135	0258.....	213	0337.....	71 & 127
0069.....	71	0164.....	135	0259.....	23, 65, 66, 72,	0338.....	71
0070.....	71 & 127	0165.....	135		84, 85 & 88	0339.....	138
0071.....	71	0166.....	140	0260.....	16 & 72	0340.....	71 & 127
0072.....	71	0170.....	15, 48, 55, 57	0261.....	72, 78, 79, 84	0341.....	84
0074.....	72		59, 60 & 61		87 & 88	0342.....	88
0075.....	161	0171.....	140	0264.....	14	0343.....	160
0076.....	155	0172.....	140	0265.....	126	0344.....	192
0077.....	115	0174.....	115	0266.....	153	0347.....	88
0078.....	114	0175.....	116	0268.....	12, 25 & 72	0348.....	157
0080.....	116	0176.....	114	0269.....	65, 66, 72, 84,	0349.....	139
0082.....	205	0178.....	112		85 & 88	0350.....	156
0086.....	151	0179.....	141	0271.....	212	0351.....	192
0093.....	12 & 62	0181.....	113	0272.....	212	0354.....	109
0095.....	12 & 62	0196.....	135	0273.....	18 & 72	0355.....	109
0106.....	88	0197.....	212	0276.....	56, 86 & 124	0357.....	189
0107.....	19 & 23	0200.....	12, 62 & 63	0277.....	14 & 72	0361.....	159
0108.....	64 & 65	0201.....	35, 40, 41, 48,	0278.....	12, 51 to 54	0362.....	49
0109.....	65		49, 51 & 72		56, 58 & 72	0363.....	153
0110.....	65	0202.....	117	0280.....	126	0365.....	161
0111.....	65	0203.....	117	0281.....	19, 56, 58 & 72	0367.....	88
0112.....	64 & 86	0212.....	213	0283.....	22, 24 & 72	0370.....	153
0113.....	140	0217.....	121	0284.....	57, 72 & 126	0371.....	49
0114.....	18 & 21	0218.....	194	0285.....	161	0372.....	125
0119.....	188	0219.....	194	0290.....	66	0373.....	88
0120.....	212	0220.....	194	0294.....	85 & 88	0374.....	88
0123.....	140	0221.....	194	0295.....	16, 56, 58 & 72	0375.....	71
0124.....	152	0222.....	63	0296.....	22, 23 & 72	0377.....	159
0125.....	41, 52 & 53	0223.....	121	0297.....	22 & 72	0380.....	196
0126.....	173	0226.....	64	0298.....	19 & 72	0390.....	42
0127.....	140	0227.....	18, 21 & 72	0300.....	123	0391.....	42
0131.....	66 & 85	0228.....	18 & 72	0301.....	158	0393.....	43
0132.....	124	0229.....	17, 20 & 72	0303.....	79 & 88	0394.....	43
0133.....	86	0232.....	17 & 72	0305.....	109	0403.....	87
0134.....	88	0233.....	201	0309.....	64 & 86	0404.....	246
0135.....	19, 22, 56 & 58	0238.....	38 & 72	0313.....	109	0412.....	87
0136.....	22	0239.....	34, 37, 39, 48,	0314.....	108	0420.....	140
0137.....	119		51, 52 & 72	0315.....	138	0424.....	135

NUMERICAL INDEX



Fig. No.	Page No.	Fig. No.	Page No.	Fig. No.	Page No.	Fig. No.	Page No.
0427	195	0533	197	0608	191	0809	96, 106 & 107
0428	195	0534	110	0609	118	0810	96, 106 & 107
0432	126 & 127	0535	110	0610	243	0811	106 & 107
0433	108 to 110	0537	172 & 174	0615	20	0816	106 & 107
0435	110	0538	110	0616	17	0817	106 & 107
0440	110	0539	183	0617	13	0820	106 & 107
0441	139	0540	164, 165 & 172	0619	20	0825	155
0443	143	0541	165	0622	19	0826	179
0447	245	0542	166	0634	198	0828	202
0448	245	0543	166	0675	224	0829	202
0449	248	0544	185	0688	134	0830	202
0452	245	0545	185	0693	0144 & 0145	0831	202
0454	87	0550	136	0697	203	0832	202
0455	48	0551	170	0701	121 to 124	0833	202
0456	149	0552	170 & 171		& 134	0834	154
0457	149	0554	218	0706	226	0835	154
0461	139	0555	124	0707	136	0836	106 & 107
0462	130 & 131	0556	176	0709	152	0837	96, 106 & 107
0465	140	0557	172	0710	226	0839	96, 106 & 107
0466	48	0559	218	0711	227	0841	240
0477	70 & 196	0561	180	0712	228	0844	96, 106 & 107
0480	248	0562	206	0714	153	0845	96, 106 & 107
0481	248	0563	176	0715	227	0846	96, 106 & 107
0482	248	0564	172	0716	228	0847	96
0483	248	0565	198	0719	242	0848	96
0484	248	0566	186	0721	152	0851	97, 101 & 109
0492	196	0567	233	0722	152	0852	97, 101 & 109
0493	146 & 147	0568	176	0730	226	0859	96
0494	110	0569	176	0731	227	0860	96, 106 & 107
0495	194	0570	181	0737	153	0866	95
0499	183	0571	180	0742	153	0869	244
0500	146 & 147	0572	184	0750	190	0870	138
0501	192	0574	217	0752	191	0872	95 & 107
0502	196	0575	240	0753	124	0873	95 & 107
0503	182	0576	172	0755	191	0874	107
0504	183	0577	166	0757	190	0875	107
0505	182	0578	244	0759	197	0876	107
0506	181	0579	167	0762	204	0878	107
0507	177	0580	168	0763	204	0879	107
0509	182	0581	168	0769	203	0880	95 & 107
0510	138	0582	169 & 171	0770	203	0883	98 & 99
0513	174, 175 & 177	0583	169 & 171	0771	207	0884	100 & 101
0514	124 & 134	0590	165 & 172	0775	193	0885	102 & 103
0515	182	0591	165	0776	239	0887	104
0518	180 & 181	0593	147 & 148	0777	234	0889	96 & 105
0520	172	0594	142	0778	235	0890	96 & 105
0524	177	0597	181	0786	134	0891	105
0525	178	0598	180	0797	204	0893	95
0526	183	0599	173	0805	148 & 154	0894	95
0527	174	0602	13	0806	96, 106 & 107	0895	95
0528	174 & 175	0606	117	0807	96, 106 & 107	0896	244
0530	186	0607	117	0808	210	0897	95

11

PERKO® NUMERICAL INDEX

Fig. No.	Page No.	Fig. No.	Page No.	Fig. No.	Page No.	Fig. No.	Page No.
0898	244	0963	19	1058	50 & 68	1149	119
0899	95	0964	56	1059	41, 45 & 69	1150	84
0901	244	0965	58	1060	45 & 69	1151	84
0902	105	0966	242	1065	217	1152	84
0903	189	0967	203	1068	231	1153	84
0904	23	0968	231	1071	223	1154	84
0905	96 & 105	0969	97, 103 & 109	1072	223	1155	201
0907	244	0972	22	1074	120	1156	119
0908	105	0975	243	1075	218	1157	122
0910	105	0976	230, 232 & 236	1081	223	1158	12, 51 to 54 & 56
0911	96	0977	231	1082	223	1161	22
0912	229 to 233	0978	236	1089	222	1164	79
0913	232 & 233	0980	237	1091	220 & 221	1165	79
0915	19	0984	229 to 232	1092	220 & 221	1166	79
0918	232		& 236	1093	238	1167	79
0919	232	0987	211	1094	224	1168	79
0920	229 to 233	0988	211	1095	224	1169	78
0921	237	0991	229	1097	224	1170	78
0922	237	0992	229	1099	246	1172	78
0924	212	0994	244	1100	246	1173	78
0925	238	0995	221 & 231	1101	236	1174	78
0926	238	0996	244	1102	236	1177	217
0927	233	0997	244	1103	240	1178	56
0928	230	0998	214	1104	246	1179	205
0929	231	0999	211	1105	78 to 87	1180	205
0930	230	1002	208	1106	243	1181	51
0931	222	1004	208	1107	246	1183	54
0932	222	1008	207	1108	207	1184	51
0934	242	1015	192	1109	66	1185	201
0935	242	1016	241	1110	241	1186	201
0937	242	1017	206	1111	86	1187	201
0938	237	1021	237	1112	207	1188	184
0939	57	1028	230	1113	207	1189	134
0941	210	1029	231	1116	205	1190	134
0942	211	1030	230	1117	205	1191	135
0944	242	1031	222	1118	247	1192	70
0945	58	1032	222	1119	78 to 87	1194	214
0946	58, 118 & 119	1040	126	1123	49, 53 & 69	1196	54
0947	215	1043	192	1124	53 & 69	1197	54
0948	236	1044	120	1125	52 & 69	1198	214
0949	209	1045	44	1127	82 & 83	1199	216
0951	210	1046	44	1128	82 & 83	1201	12
0952	209	1047	44	1129	82, 83 & 87	1205	246
0953	232	1048	46	1130	82 & 83	1209	41 & 69
0954	241	1049	46	1131	49	1210	184
0955	16	1050	192	1133	78 & 79	1211	25
0956	216	1051	238	1134	51 & 78	1212	25
0957	213	1052	50 & 68	1137	51	1213	211
0958	241	1053	215	1138	51	1214	211
0959	214 & 216	1054	50 & 68	1143	79 & 87	1215	247
0960	233	1056	237	1144	50 & 189	1216	217
0962	230 to 233	1057	190	1146	118 & 119	1217	217

NUMERICAL INDEX



Fig. No.	Page No.	Fig. No.	Page No.	Fig. No.	Page No.	Fig. No.	Page No.
1218	23	1293	210	1378	80 & 81	1642	51
1220	239	1299	199	1379	80 & 81	1656	37
1221	239	1301	48	1380	80 & 81	1901	93 & 94
1222	193	1302	194	1384	74	1902	93 & 94
1223	188	1303	121	1385	74	1921	93 & 94
1226	197	1304	195	1386	74	1922	93 & 94
1227	200	1305	187	1387	74	1925	93 & 94
1230	188	1306	187	1388	74	1930	95
1231	193	1309	199	1399	173	1931	95
1232	240	1310	22	1400	35	1932	96
1234	193	1311	41	1401	40	1933	96
1235	191	1312	138	1403	40	1936	96
1236	54	1313	187	1404	40	8501	130
1238	136	1316	167	1421	25	8502	130
1239	231	1318	167	1422	25	8503	130
1240	231	1319	167	1440	38	8504	130
1241	179	1322	194	1441	38	8511	129
1242	206	1323	124	1442	36	8512	129
1243	198	1324	173 & 178	1443	36	8603	132
1244	215	1325	192	1445	38	9304	89 & 90
1246	199	1326	187	1447	38	9501	92
1247	179	1327	195	1450	39	9504	92
1248	179	1330	41	1451	34	9506	92
1249	244	1331	56	1452	39	9508	892
1252	186	1332	58	1454	39	9510	90 to 92
1253	123	1336	193	1455	39	9511	90 & 92
1254	120	1342	74	1456	39	9512	91 & 92
1256	198	1343	33	1459	39	9514	92
1258	124	1344	47	1460	37	9521	91 & 92
1260	124	1345	47	1461	37	9530	92
1261	198, 214 & 216	1346	193	1465	37	9551	90 to 92
1262	200	1347	32	1470	34	9560	92
1263	123	1348	33	1601	19	9563	92
1264	16	1349	32	1602	19	9565	92
1267	200	1353	215	1604	48	9566	92
1269	177	1354	215	1607	52	9568	92
1270	174	1355	215	1608	47	9581	92
1271	136	1356	122	1609	52	9582	92
1273	53	1357	122	1611	41	9601	131
1274	53	1358	122	1612	24	9602	131
1277	195	1363	75 to 77	1613	173	9603	131
1278	195	1364	77	1614	24	9604	131
1279	232	1365	77	1618	24	9611	129
1280	232	1366	77	1622	38	9612	129
1281	51	1367	77	1624	36	9703	132
1283	51	1368	77	1627	67	9854	89 & 91
1284	51	1369	76	1628	67		
1287	216	1370	76	1634	51		
1289	199	1372	76	1636	51		
1290	205	1373	76	1637	51		
1291	205	1374	76	1638	51		
1292	205	1377	80 & 81	1639	51		

11

	PAGE
A	
Adapter - Pipe to Hose	155
Adjusters - Hatch	204
Windshield	205
Alpha Series Lights	35
All-Round Lights	30, 32 to 43, 47 to 54, 62 to 65 & 74 to 87
Anchor Chocks	189
Anchor Lights	30, 32 to 43, 47 to 54, 62 to 65 & 74 to 87
Arch Tower Mount Lights.....	52
Assemblies, Control.....	90, 91, 93, 94, 97, 101 & 103
Axe Bracket	206
B	
Bass Boat Lights	19 & 24
Bases, Pole Light	43 to 46, 50 & 67 to 69
Battery - Switches	128 to 133
Cable Spacer	130 & 131
Bells, Fog.....	140 & 141
Berth Lights	118 & 124
Bi-Color Lights.....	20 to 25 and 60 to 63
Bits.....	191
Boarding Steps	192
Bolts - Barrel	215
Cupboard	236
Bow - Lights	13 to 25, 59 to 63, 65, 66 & 74 to 85
Anchor Lights	30, 32 to 43, 47 to 54, 62 to 65 & 74 to 87
Combination Lights	12, 20 to 25, 52 to 54, 60 to 63, 65 & 74 to 79
Eyes	181
Brackets - Axe	206
Table	243
Breakdown Lights	74 to 87
Bulbs, Electric.....	71, 88, 92, 96, 106, 107 & 127
Butt Hinges	208 to 210
Buttons - Door	217
Horn Push.....	134
C	
Cabin Door Hooks	216
Cabinet Hinges	208 to 213
Cable - Outlet	135
Spacer	130 & 131
Straps.....	135
Caps, Gas Tank.....	164 to 175
Catches, Door	217, 218, 236 & 237
Certification of Lights	8 & 73
Chain - Deck Pipe	190
Portlight	139
Chocks.....	188
Chocks, Anchor	189
Choosing a Pole Light	29
Clam Shell Ventilators	138
Clamps -	

	PAGE
C CONTINUED	
Hatch Hold-Down.....	207
Spring	196
Rope.....	197
Security	203
Clear Back Utility Light	119
Cleats	184 to 187
Clips - Line Support	135
Coat & Hat Hooks	243
Cockpit Scupper	159 to 161
Color Coded Deck Plates & Fills.....	168 to 171 & 176
Collar Set	70
Combination - Bow & Anchor Lights	12 & 20 to 25
Side Lights	13 to 19, 59 to 63, 65, 66 & 74 to 85
Connections - Electric.....	135
Thru Hull	151, 154 & 156 to 161
Watertight, Deck	135
Connectors, Electric	135
Connectors, Garden Hose.....	183
Continuous Hinge.....	213
Control Assemblies.....	90, 91, 93, 94, 97, 101 & 103
Courtesy Lights	117 to 124
Cowl Ventilators	138
Cupboard - Bolts	236
Catches	218, 236 & 237
Turns	236
Curtain Fasteners	244
D	
Deck - Connection, Watertight.....	134 & 135
Lights.....	55, 60, 125 & 126
Pipes, Rope & Chain.....	190
Plate Keys	179
Plates	164 to 177 & 183
Delta Series Pole Lights	34
Dock Line Springs	197
Docking Lights.....	117
Dome Lights	122 to 124
Door - Buttons	217
Catches	217, 218, 236 & 237
Fasteners	244
Hinges	208 to 213
Holders.....	217 & 218
Hooks	216
Stops	217 & 242
Dorade Ventilator	138
Drain Plugs	152 & 153
Drawer - Knobs	238
Pulls.....	238 & 241
Dredging Light	87
E	
Elbow Catches.....	237
Electric - Bulbs	71, 88, 92, 96, 106, 107 & 127
Cabin Fixtures	121 to 124
Connections.....	135
Lamps	121 to 124
Sockets.....	66, 88, 106, 107 & 127
Switches	128 to 134

ALPHABETICAL INDEX

E CONTINUED

PAGE

European Representative	9
Eyes -	
Bow	191

F

Fasteners -	
Curtain	244
Door	244
Hatch	244
Table Leg	243
Fender-	
Hooks	199 & 206
Locks	199
Filler, Tank	164 to 175
Filters, Water	142 to 152
Fishing Rod Holders	245 to 248
Fittings -	
For Rails	196
Waste	176 & 177
Fixtures, Light -	
Bulkhead, Electric	118 & 121
Electric Cabin	118 to 124
Flag Pole Sockets	194 & 195
Flag Staffs	194 & 195
Flush Pro	149
Flush -	
Hatch Lifting Handles	219 to 224, 234, 235 & 239
Hatch Lifting Rings	238 to 240
Locks & Latches	219 to 235
Pulls	238 to 241
Ring Catch	238
Fog Horn	139
Fold Down Mount Lights	43, 50 to 52, 67 & 68
Fuel Tank Filler	164 to 175
Fuse Holder	134

G

Gas -	
Tank Caps	164
Tank Filler	164 to 175
Tank Vents	180 to 182
Gasket Kit	248
Globe Styles	30
Grab Rail Posts	196
Guides, Tiller Rope	198

H

Halyard Mount Lights	62
Handles -	
Flush Lifting	234, 235 & 239
Sliding Window	241
Hasps	214
Hatch -	
Adjusters	204
Dog	234 & 235
Fasteners	203 & 207
Hinges	208 to 213
Hold-Down Clamps	207
Lifting Handles	234, 235 & 239
Lifting Rings	238 & 240
Trim	213
Support Braces	204
Hawse Hole Plates	191
Heavy Duty Pole Lights	42 & 43
Heights, Vertical Light	26 to 28

H CONTINUED

PAGE

Hinges -	
Butt	208 to 210
Cabinet	208 to 213
Continuous	213
Cuddy Door	208 to 213
Hatch	208 to 213
Hatch Support	204
Non-Mortised	213
Piano	213
Pull Apart	213
Semi-Concealed	212
Shortside	211
Strap	212
“T”	212
Holders -	
Boat Hook	206
Door	217 & 218
Fishing Pole	245 to 248
Ring Buoy	206
Hooks -	
Cabin Door	216
Coat Hook	243
Fender	199 & 206
Lashing	244
Snap	199
Utility	243
Wardrobe	243
Horn, Fog	139
Horns for Rowlocks	200 & 202
Hull Connections	156 to 161

I

Information -	
Certification of Navigation Lights	8 & 73
Determining the Hand of a Lock or Latch Set	225
Electrical Standards	128
Light, Vertical Heights	26 to 28
Lock Bevels	225
Lock & Latch	219 to 235
Representatives	9
Searchlight Bulb Data	92, 96, 106 & 107
Sales Policy & Terms	7
Warranty	7
Inlet -	
Fittings for Fresh Water	183
Strainer	142 to 152
Intake Strainers -	
Clear Body	143
Duplex	142
Flushing	148
Heavy Duty	144 & 145
Intake	142 to 148 & 151
Pump	152
Round	151
Scoop	151

K

Keys, Deck Plate	179
Knobs, Drawer	238

L

Lamps -	
Cabin	118 to 124
Wall	118 & 121
Lashing Hooks	244
Latches -	

12

L CONTINUED	PAGE
Doors.....	219 to 237
Flush	219 to 237
Mortise Latch Sets	226, 228 & 233
Rim Latch Sets	230 to 232
Slam.....	224
Slam Cam Bar.....	218
Leathers, Oar.....	201
L.E.D.	
Berth Lights	118 & 124
Deck Lights	55, 60, 125 & 126
Docking Lights	117
Dome Lights	122 to 124
Navigation Lights	12 to 88
Underwater Lights.....	111 to 116
Utility Lights	117 to 120
Light Chart, Vertical Heights	26 to 28
Lights -	
Alpha.....	35
Arch/Tower.....	52
All-Round Lights	30, 32 to 43, 47 to 54, 62 to 65 & 74 to 87
Anchor Lights	30, 32 to 43, 47 to 54, 62 to 65 & 74 to 87
Bases - Polelights	43 to 46, 50 & 67 to 69
Bass Boat	19 & 24
Berth	118 & 124
Bi-Color	20 to 25 & 60 to 63
Breakdown	74 to 87
Camo	Contact Factory
Combination	12, 20 to 25, 52 to 54 & 61 to 63
Courtesy.....	117 to 124
Deck	55, 60, 125 & 126
Delta	34
Dredging.....	87
Dome.....	122 to 124
Flashing.....	86
Fold Down	43, 50 to 52, 67 & 68
L.E.D	13, 17, 20, 24, 32, 33, 36, 39, 47, 51, 52, 59, 74, 112 to 114, 117 to 120, 122, 124 & 125
Masthead.....	52 to 56, 59 to 63, 65, 66 & 74 to 85
Meal & Absent	65
Not Under-Command	74 to 87
Omega.....	33
Pole	30 to 43 & 47 to 54
Range.....	74 to 87
Searchlights	89 to 110
Side	13 to 19, 59 to 63, 65, 66 & 74 to 85
Signal	59 to 68 & 74 to 84
Spreader	55, 60 & 126
Stealth.....	13, 17, 20, 24, 32, 36, 39, 47, 51 & 52
Stern.....	57 to 62, 65, 66 & 74 to 85
Surface Mount.....	112 & 113
Towing	59 to 62, 65, 66 & 74 to 85
Tri-Color	12 & 62
Trim Tab Mount	112
Underwater.....	111 to 116
Utility	117 to 120
Line Support Clips.....	135
Locks -	
Doors.....	219 to 237
Fender	199
Flush	219 to 237
Mortise	226, 228 & 233
Rim	230 to 232
Window	242

L CONTINUED	PAGE
Locker Ventilators	136
Louver Ventilators	137
Locking Inserts.....	178
M	
Marinium.....	Contact Factory
Masthead	52 to 56, 59 to 63, 65, 66 & 74 to 85
Meal & Absent.....	65
Mooring Bitts	191
N	
Navigation Lights -	
For Vessels:	
Under 20 Meters (65.6 Ft.) in Length	12 to 72
Over 20 Meters (65.6 Ft.) in Length	73 to 88
O	
Oar -	
Leathers & Buttons	201
Locks	200 to 202
OEM Packaged Pole Lights	36 to 40
Omega Series	33
Outlets -	
Cable	135
Water	183
P	
Piano Hinge	213
Pipes, Rope Deck	190
Plates -	
Deck	164 to 177 & 183
Hawse Hole.....	191
Step	192
Plugs, Drain	152 & 153
Pole Holders -	
Replacement Bases	43 to 46
Replacement Poles	32 to 41 & 49
Vertical Height Chart	26 to 28
Pole Lights.....	30 to 43 & 47 to 54
Pole Lights, Heavy Duty	42 & 43
Pole Light Bases	43 to 46, 50 & 67 to 69
Pole Sockets, Flag	194 & 195
Poles -	
Flag.....	195
Posts -	
Grab Rail.....	196
Stanchion	196
Pulleys	198
Pulls -	
Drawer.....	238 to 241
Flush	238 to 241
Pump Strainers	152
R	
Rail Fittings.....	196
Range Lights	74 to 87
Representatives.....	9
Retail Packaged Pole Lights.....	32 to 35
Remote Control Searchlights	89 to 94 & 104
Rigging Tube	189
Rim Locks	230 to 232
Rim Latches	230 to 232
Ring -	
Buoy Holders.....	206
Catches, Flush	238

PERKO®

ALPHABETICAL INDEX

R CONTINUED **PAGE**

Pulls.....238 & 240
 Rings, Hatch Lifting.....238 & 240
 Rope -
 Clamps197
 Guides198
 Pulleys.....198
 Rowlocks200 to 202

S

Safety Cable174
 Scuppers -
 Cockpit.....159 to 161,
 Thru-Hull159 to 161
 Valve Assembly154
 Seacocks154
 Searchlights -
 Bulbs92, 96, 106 & 107
 Control Assemblies90, 91, 93, 94, 97, 101 & 103
 Incandescent93 to 107
 Sealed Beam.....108 to 110
 Remote Control86 to 89 & 89
 Spare Parts92, 95, 96, 106 & 107
 Xenon89 to 92
 Self Adjusting Slam Latch218
 Shield, for Pole or Mast Lights.....70
 Side Lights.....13 to 19, 59 to 63, 65, 66 & 74 to 85
 Signal Lights, Portable
 or Fixed.....59 to 68 & 74 to 84
 Snap Hooks199
 Sockets -
 Boat Cover.....244
 Sockets.....43 to 46, 66, 68, 69, 88, 95, 106 & 107
 Fishing Rod.....245 to 248
 Flag Pole194 & 195
 Rowlock200 to 202
 Searchlight.....95, 106 & 107
 Spreader Lights55, 60 & 126
 Spotlights.....108 to 110
 Spring Clamps196
 Springs for Dock Line197
 Staffs, Flag194 & 195
 Steps -
 Boarding.....192
 Folding192
 Stern -
 Lights.....57 to 62, 65, 66 & 74 to 85
 Pole Lights30 to 54
 Stops -
 Door.....217 & 242
 Window242
 Strainers -
 Clear Body143
 Duplex142
 Flushing.....148
 Inlet142 to 148 & 151
 Pump.....152
 Thru-Hull151
 Water142 to 151
 Strap Hinges.....212
 Strap Cable135
 Switches -
 Battery128 to 133
 Electric.....128 to 134
 Master.....128 to 133
 Panel.....131

S CONTINUED **PAGE**

Swivel -
 Eye Pulleys198
 Eye Snaps.....199

T

“T” Hinges.....212
 Table Brackets.....243
 Table Leg Fasteners242
 Thru-Hull Connections.....151, 154 & 156 to 161
 Tower/Arch Mount Lights.....52
 Towing Lights.....59 to 62, 65, 66 & 74 to 85
 Transom -
 Eyes181
 Stern Lights.....57 to 62, 65, 66 & 74 to 85
 Ventilators.....136 & 138
 Trim, Hatch.....213
 Tube, Rigging189
 Tri-Color Lights.....12 & 62
 Turns, Cupboard.....236

U

Underwater Lights111 to 116
 L.E.D.112 to 114
 Incandescent.....115 & 116
 Surface Mount.....112 & 113
 Thru-Hull Mount114 to 116
 Trim Tab Mount112
 Universal Replacement Pole Light32 to 40
 Utility Hooks.....243
 Utility Lights.....117 to 120
 Clear Back.....119
 L.E.D.117 to 120

V

Ventilator -
 Cowl.....138
 Dorade.....138
 Gas Tank180 to 182
 Locker.....136 & 137
 Louver137
 Clam Shell Type1238
 Transom136 & 137

W

Wardrobe Hooks243
 Warranty Information7
 Waste Fitting176 & 177
 Water Tight Deck Connection134 & 135
 Water Strainers.....142 to 152
 Water Strainer Graphs144, 147 & 149
 Whistle.....139
 White Line11, 13-15, 17, 18, 20, 21, 24, 25, 32, 33,
 36-40, 44, 46, 47, 48, 54-57, 59, 60, 65, 70,
 81, 83, 125, 166, 167, 180, 181, 220 & 222-224
 Window -
 Anti-Rattler242
 Handle, Sliding.....241
 Lock242
 Stop242
 Windshield -
 Adjusters205
 Keeper Plate203
 Wiper.....197

12

WE ARE MEMBERS OF THE FOLLOWING ASSOCIATIONS:



National Marine
Manufacturers Association



American Boat & Yacht
Council, Inc.
Charter Member

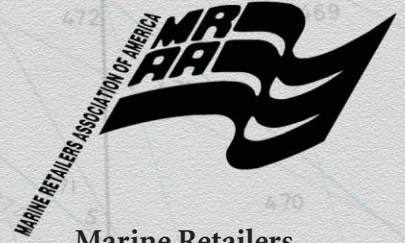

Marine Retailers
Association of America

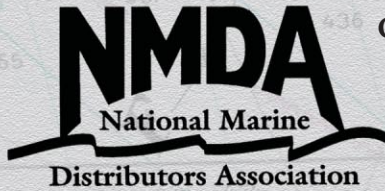

National Marine Distributors As-
sociation



Marine Industries Association
of South Florida

Manufacturer of Marine Lights, Hardware and Accessories

Street Address:

16490 Northwest 13th Avenue
Miami, Florida 33169-5707

Telephone Number: (305) 621-7525

Fax Number: (305) 620-9978

Mailing Address:

P.O. Box 64000D
Miami, Florida 33164-0510

e-mail: sales@perko.com

Website: www.perko.com

The PERKO logo is displayed on a white sign with a blue wave graphic below the text. The word "PERKO" is written in a bold, blue, sans-serif font. The background of the entire page is a photograph of a modern, blue and white building with a palm tree and an American flag in the foreground.



Manufacturer of Marine Lights, Hardware and Accessories